

V-TAC

Meaningful Innovation.

WEEE Number: 80133970

INSTRUCTION MANUAL 5kW ON GRID INVERTER



MODEL	VT-6607005
SKU	11832

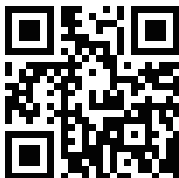

MULTI-LANGUAGE MANUAL

Please scan the QR code to access the manual in multiple languages.

IN CASE OF ANY QUERY/ISSUE WITH THE PRODUCT PLEASE REACH OUT TO US AT
SUPPORT@VTACEXPORTS.COM V-TAC HOUSE, KELPATRICK ROAD, SLOUGH, BERKSHIRE, SL1 6BW, UK.

Contents

1. About This Manual	1
1.1 Scope of Validity	1
1.2 Target Group	1
1.3 System Diagram	1
2. Safety & Symbols	2
2.1 Safety Precautions	2
2.2 Explanations of Symbols	3
3. Installation	4
3.1 Pre-installation	4
3.1.1 Unpacking & Package List	4
3.1.2 Product Overview	5
3.1.3 Mounting Location	6
3.2 Mounting	7
4. Electrical Connection.	8
4.1 PV Connection	8
4.2 Grid Connection	11
4.3 Communication Connection	13
4.4 Zero-injection Smart Meter (Optional)	14
5. Operation	16
5.1 Control Panel	16
5.2 Menu Structure	17
5.3 Setting	18
5.3.1 Startup	18
5.3.2 Voltage Range	18
5.3.3 Frequency Range	19
6. Commissioning	20
7. Start-up & Shut Down	20
7.1 Shut down	20
7.2 Restart	20
8. Maintenance&Trouble Shooting	21
8.1 Maintenance	21
8.2 Trouble Shooting	21
9. Specifications	25

1. About This Manual

1.1 Scope of Validity

This manual describes the installation, commissioning, operation and maintenance of the following on-grid PV inverters produced by VTAC:

Single Phase Ongrid Inverter:
VT-6607005

Please Keep This Manual All The Time Available In Case Of Emergency.

1.2 Target Group

This manual is for qualified personnel. The tasks described in this manual must only be performed by qualified personnel.

1.3 System Diagram

The typical on-grid PV system connection diagram.

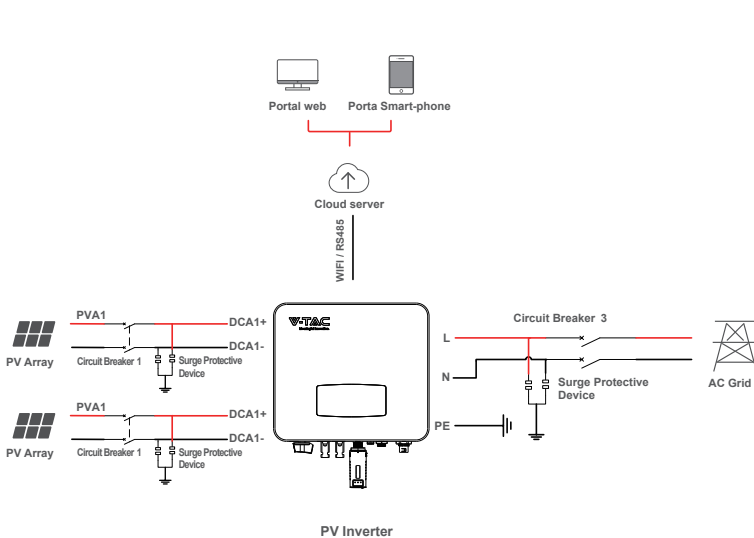

Circuit Breaker Recommendation

Type	Max AC Current (A)	Rated current of AC breaker (A)
Single Phase Ongrid Inverter		
VT-6607005	23	32

Surge Protector Recommendation

- AC side, nominal discharge current 20KA, second grade lightning protection, protection voltage 2.5KV.
- DC side, nominal discharge current 20KA, second grade lightning protection, protection voltage 3.2KV.
- The wiring distance between the inverter and the distribution box should be at least 5 meters.

Note:



The Inverter can be only connected to low-voltage grid. (220/230Vac, 50/60Hz).

2. Safety & Symbols

2.1 Safety Precautions

1. All work on the inverter must be carried out by qualified electricians.
2. The device may only be operated with PV panels.
3. The PV panels and inverter must be connected to the ground.
4. Do not touch the inverter cover until 5 minutes after disconnecting both DC and AC power supply.

5. Do not touch the inverter enclosure when operating, keep away from materials that may be affected by high temperatures.
6. Please ensure that the used device and any relevant accessories are disposed of in accordance with applicable regulations.
7. VTAC inverter should be placed upwards and handled with care in delivery. Pay attention to waterproof. Do not expose the inverter directly to water, rain, snow or spray.
8. Alternative uses, modifications to the inverter not recommended. The warranty can become void if the inverter was tampered with or if the installation is not in accordance with the relevant installation instructions.

2.2 Explanations of Symbols

VTAC inverter strictly comply with relevant safety standards. Please read and follow all the instructions and cautions during installation, operation and maintenance.



Danger of electric shock

The inverter contains fatal DC and AC power. All work on the inverter must be carried out by qualified personnel only.



Beware of hot surface

The inverter's housing may reach uncomfortably hot 60°C (140°F) under high power operation. Do not touch the inverter enclosure when operation.



Residual power discharge

Do not open the inverter cover until 5 minutes after disconnection both DC and AC power supply.



Important notes

Read all instructions carefully. Failure to follow these instructions, warnings and precautions may lead to device malfunction or damage.



Do not dispose of this device with the normal domestic waste.



Without transformer

This inverter does not use transformer for the isolation function.



CE mark

The inverter complies with the requirements of the applicable CE guidelines.



Refer to manual before service.

3. Installation

3.1 Pre-installation

3.1.1 Unpacking & Package List

Unpacking

On receiving the inverter, please check to make sure the packing and all components are not missing or damaged. Please contact your dealer directly for supports if there is any damage or missing components.

Package List

Open the package, please check the packing list shown as below.

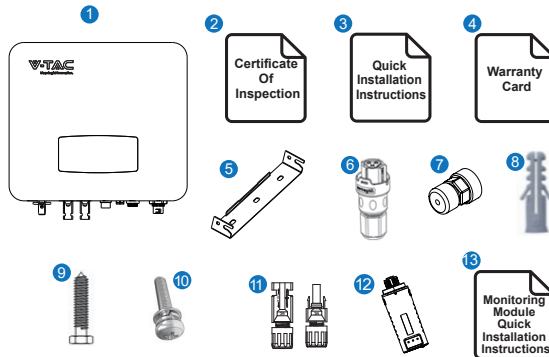

No.	Qty	Items	No.	Qty	Items
1	1	Solar inverter	8	3	Plastic Expansion Tube
2	1	Certificate Of Inspection	9	3	Tapping Screw
3	1	Quick Installation Instructions	10	1	Security Screw
4	1	Warranty Card	11	2	DC Connector sets
5	1	Wall Mounting Bracket	12	1	Monitor Module
6	1	AC Connector	13	1	Monitoring Quick Installation Instructions
7	1	Zero-Injection Connector (Optional)			

3.1.2 Product Overview

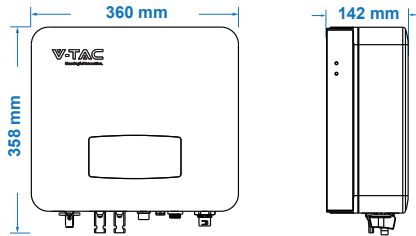

Inverter Terminals

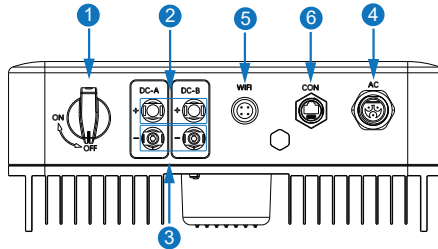

No.	Items
1	DC Switch
2	DC Connectors (+) For PV Strings
3	DC Connectors (-) For PV Strings
4	AC Connector
5	Monitor Module Port
6	Zero-Injection Port (Optional)

3.1.3 Mounting Location

The inverters are designed for indoor and outdoor installation (IP65), to increase the safety, performance and lifespan of the inverter, please select the mounting location carefully based on the following rules:

- The inverter should be installed on a solid surface, far from flammable or corrosion materials, where is suitable for inverter's weight and dimensions.
- The ambient temperature should be within $-25\text{ C} \sim 60\text{ C}$ (between $-13\text{ }^{\circ}\text{F}$ and $140\text{ }^{\circ}\text{F}$).
- The installation of inverter should be protected under shelter. Do not expose the inverter to direct sunlight, water, rain, snow, spray lightning, etc.

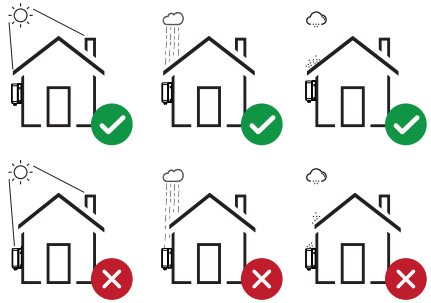

- The inverter should be installed vertically on the wall, or lean back on plane with a limited tilted angle. Please refer to below picture.

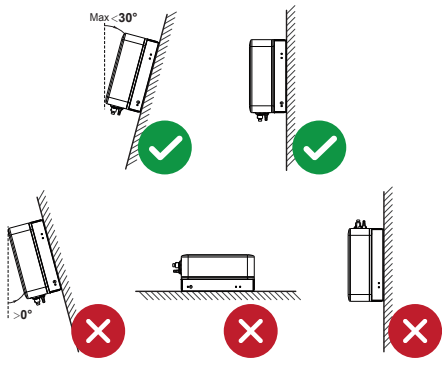

07 Installation

- Leave the enough space around inverter, easy for accessing to the inverter, connection points and maintenance.

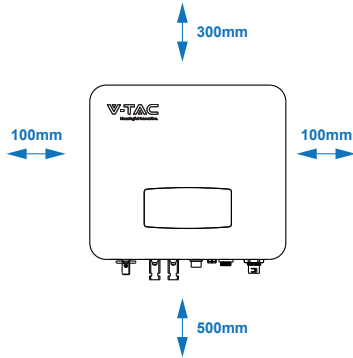

3.2 Mounting

Step 1

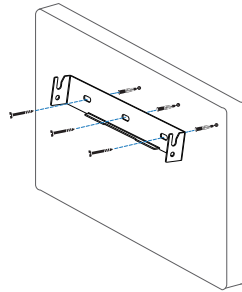
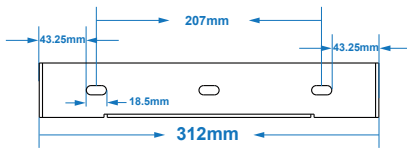

Step 2

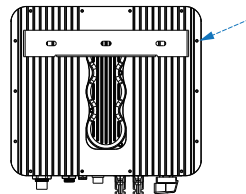
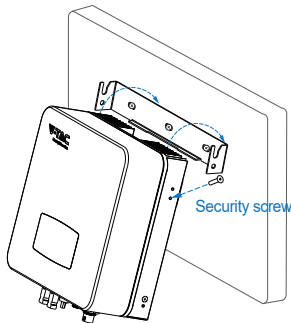

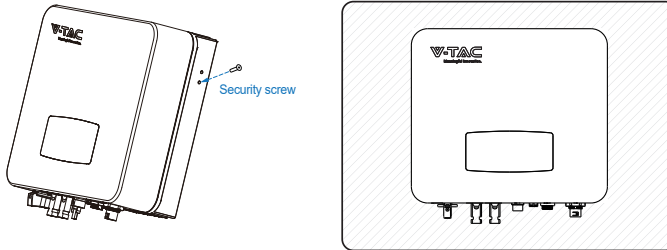
Step 3

4. Electrical Connection

4.1 PV Connection

The inverter is equipped with 2 MPPT channels, each of which contains a PV string input.

For the best results, make sure that each MPPT channel is correctly connected with PV string. Otherwise, the inverter will activate voltage or current protection automatically.

Please make sure below requirements are followed:

- The open-circuit voltage and short-circuit current of PV string should not exceed the reasonable range of the inverters.
- The isolation resistance between PV string and ground must exceed 10 k Ω .
- The polarity of PV strings are correct.
- Use the DC plugs in the accessory.
- The lightning protector should be equipped between PV string and inverter.
- Disconnect all of the PV (DC) switch during wiring.

**Warning:**

The fatal high voltage may on the DC side, please comply with electric safety when connecting.

Please make sure the correct polarity of the cable connected with inverter, otherwise inverter could be damaged.

Step 1

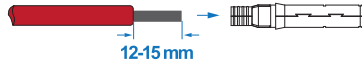

12-15 mm

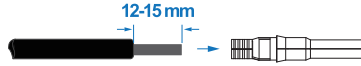

12-15 mm



Note:

PV cable suggestion
Cross-section
4mm²

Step 2

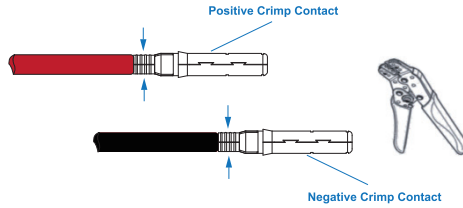

Positive Crimp Contact

Negative Crimp Contact



Note:

Please use PV connector crimper to pinch the point of the arrow.

Step 3

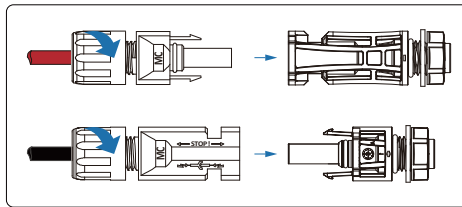
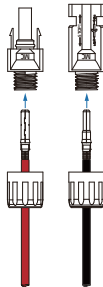

Note:

You'll hear click sound when the connector assembly is correct.

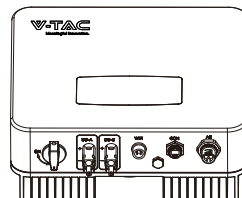

 **Note:**
PV string suggestion:

 **Correct Installation:**

Channel A and B connected with PV strings separately

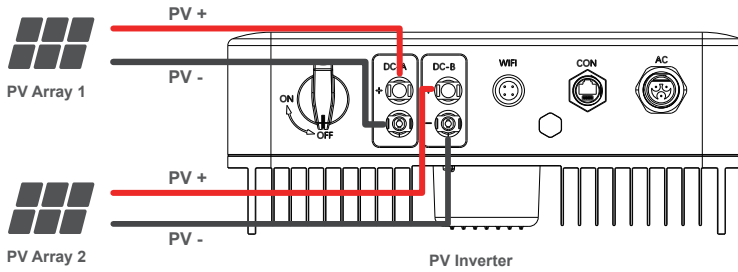

 **Wrong Installation:**

Do not connect more than two PV strings into one channel

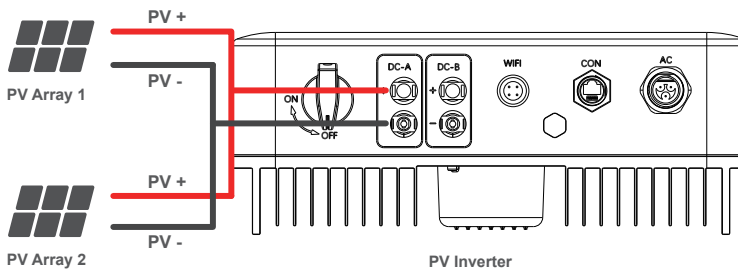

4.2 Grid Connection

The external AC switch should be installed between inverter and grid to isolate from grid. Please make sure below requirements are followed before connecting AC cable to the inverter.

- The AC (grid) voltage should not exceed the reasonable range of the inverters.
- The phase-line from AC distribution box are correctly connected.
- Use the AC plugs in the accessory.
- The surge protector should be equipped between grid and inverter.
- Disconnect the AC (grid) switch during wiring.



Warning:

The fatal high voltage may on the AC side, please comply with electric safety when connecting. Please make sure the right line of AC grid connected with inverter, otherwise inverter could be damaged.

Step 1

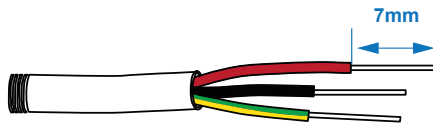

Note:

AC cable suggestion
Cross-section
4mm²

Step 2

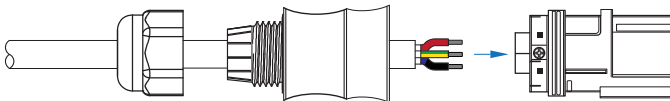

Note:

AC line goes through AC terminal waterproof head and cap

Step 3

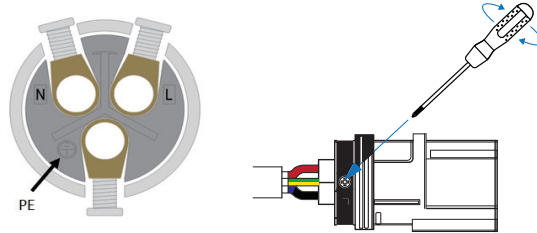

Connect AC line, Live line (L), Neutral line (N) and Ground Wire (PE) according to polarity.

Step 4

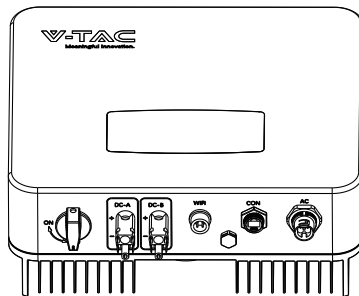

1. Connect AC terminals and waterproof head, tighten the cap, make sure they clip closely together.
2. Connect AC connector to AC terminal of the inverter.
3. After making sure that it is firmly inserted, tighten the sleeve on the AC connector to the right and hear a click.



4.3 Communication Connection

The monitoring module could transmit the data to the cloud server, and display the data on the PC, tablet and smart-phone.

Install the WIFI / Ethernet / GPRS / RS485 Communication

WIFI / Ethernet / GPRS / RS485 communication is applicable to the inverter. Please refer to "Communication Configuration Instruction" for detailed instruction.

Step 1

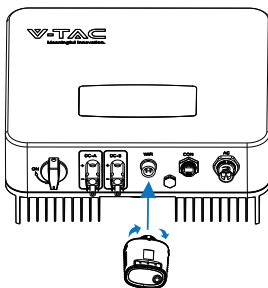

Step 2

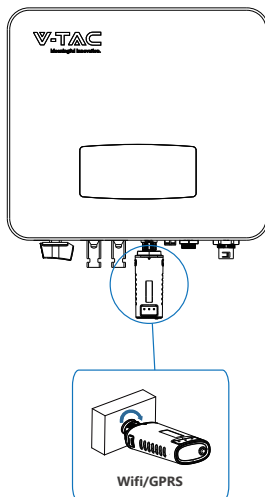

4.4 Zero-injection Smart Meter (Optional)

Smart meter is an intelligent control equipment which is used for on-grid inverters. Its main function is to measure the forward and reverse power on the grid-connected side, and transmit data to the inverter through RS485 communication to ensure that the power of the inverter is less than or equal to the user's home load, and no current flows into the grid.

Step 1

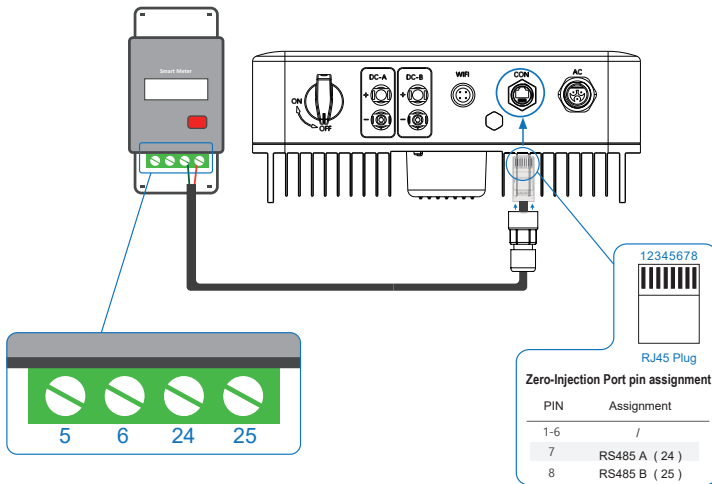

Note:

For single-phase inverter, please follow below pin order
 RS485A(Pin 7) to single-phase meter (Pin 24)
 RS485B(Pin 8) to single-phase meter (Pin 25)

15 Electrical Connection

Step 2

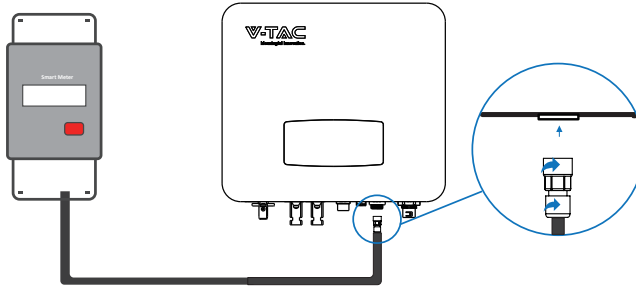

Note:

Please refer to "Zero Injection Smart Meter Installation and Operation Manual" for detailed instruction.

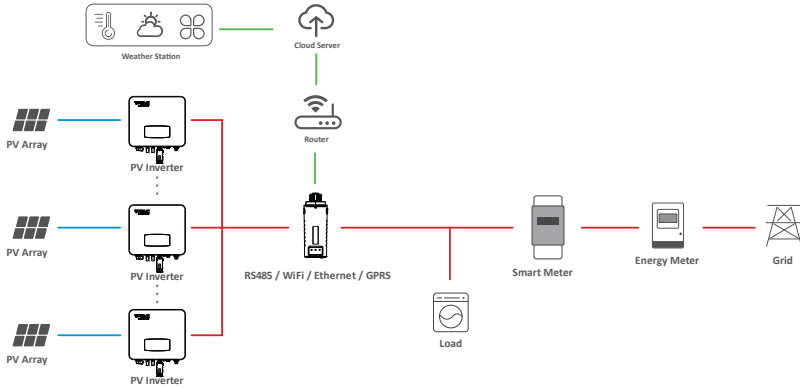

Note:

The Inverter could be connected in parallel with Smart Meter, make sure the total load power not exceed Smart Meter's limitation.

5. Operation

5.1 Control Panel

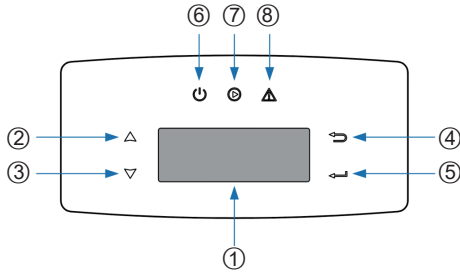

No.	Items	No.	Items
1	LCD Display	5	ENT Touch Button
2	UP Touch Button	6	POWER LED Indicator
3	DOWN Touch Button	7	GRID LED Indicator
4	ESC Touch Button	8	FAULT LED Indicator

Sign	Power	Color	Explanation
POWER	ON	Green	The inverter is stand-by
	OFF		The inverter is power off
GRID	ON	Green	The inverter is feeding power
	OFF		The inverter is not feeding power
FAULT	ON	Red	Fault occurred
	OFF		No fault

Explanation of LCD Display Content

Nouns	Explanation
Inverter Info	Display the serial number and firmware version of inverter
Error Record	Check the error list of inverter including date and time
Wifi Info	Display the WIFI serial number and assigned IP address
Date & Time	Set date and time of the inverter
Setting	Set the protection parameters of inverter
Function Enable	Countercurrent power switch
Zero Injection	Meter switch

5.3 Setting

5.3.1 Startup

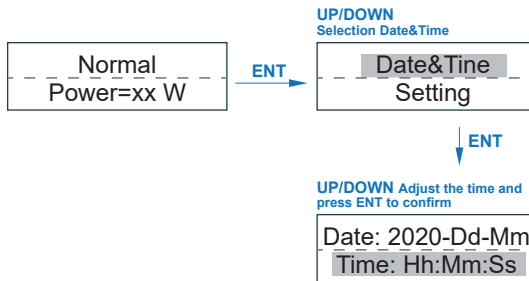

5.3.2 Voltage Range

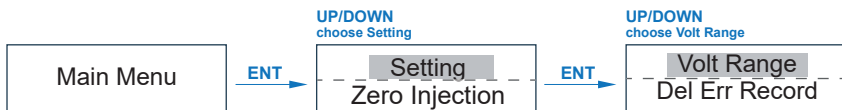

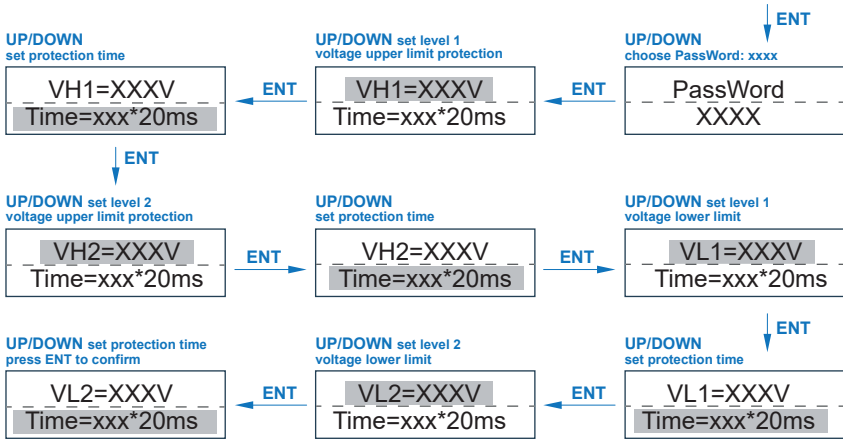

5.3.3 Frequency Range

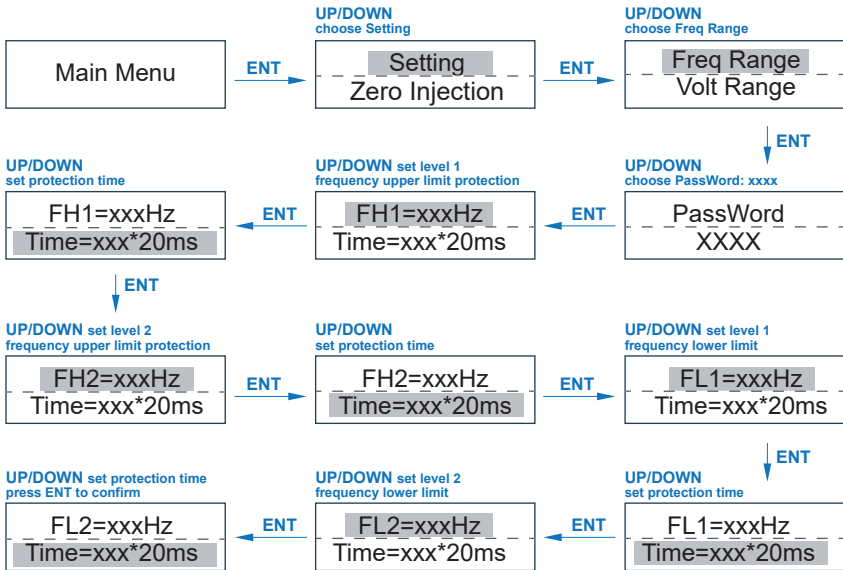

Note:

The parameters setting only works after the inverter is restarted.

6. Commissioning

Before starting up commissioning at site, please make sure below procedures and requirements are fully meet.

- Mounting location is meet the requirements.
- All of the electrical wiring is firmly connected, including PV wiring, Grid wiring and Earth wiring.
- The inverter setting has been finished accordingly to local standards or regulations.

Commissioning Procedures

- Turn on the AC switch between inverter output and the public grid;
- Turn on the DC switch on the inverter;
- Turn on the PV switch of the system.

7. Start-up & Shut Down

7.1 Shut down

- Turn off the DC switch on the inverter.
- Turn off the DC switch between PV panels and the inverter (if any).
- Close the AC switch between the inverter and the public grid.



Note:

The inverter will be operable after minimum 5 minutes.

7.2 Restart

- Shut down the inverter according to Chapter 7.1.
- Start-up the inverter according to Chapter 6.

8. Maintenance&Trouble Shooting

8.1 Maintenance

Periodically maintenance are necessary, please follow steps as below.

PV connection: twice a year

AC connection : twice a year

Earth connection: twice a year

Heat sink: clean with dry towel once a year.

8.2 Trouble Shooting

Fault messages will be displayed when fault occurs, please according to trouble- shooting table find related solutions.

Trouble-Shooting List

Type of Fault	Name	Description	Recommend Solution
PV Fault	Isolation Fault	The impedance between ground and PV (+) & PV (-) is too low, beyond the reasonable range.	<ul style="list-style-type: none"> Check whether the battery and wiring are immersed in water and whether the insulation layer is damaged, and then make corrections. If the fault occurs continuously and frequently, please ask help for local distributors.
	PV Volt Low	The DC input voltage from PV strings is below the minimum reasonable value.	<ul style="list-style-type: none"> Reconfigure the PV strings by increasing the number of PV strings to increase DC input voltage. Contact local distributors for suggestions and solutions.
	PV Volt High	The DC input voltage from PV strings is exceeding the maximum reasonable value.	<ul style="list-style-type: none"> Reconfigure the PV strings by reducing the number of PV strings to decrease DC input voltage. Contact local distributors for suggestions and solutions.
	PV1 Over Current	PV1 current is too high, protection is triggered.	<ul style="list-style-type: none"> Power off, then restart (Ref. Chapter6) If fault still occurs continuously and frequently, please ask help for local distributors.
	PV2 Over Current	PV2 current is too high, protection is triggered.	
Grid Fault	Island Fault	The public grid is outage or the grid is disconnected to the inverter.	<ul style="list-style-type: none"> The fault will disappear automatically when the public grid go back to normal. Contact the local distributor or grid company to adjust the voltage protection parameters.
	10min Over Volt	The 10-minute average value of the grid voltage is abnormal and beyond the protection range.	<ul style="list-style-type: none"> Power off, then restart (Ref. Chapter6) If fault still occurs continuously and frequently, please ask help for local distributors.
	Grid Volt Fault	Grid voltage is abnormal, beyond the protection range.	<ul style="list-style-type: none"> The fault will disappear automatically when the grid voltage is back to normal. If fault still occurs continuously and frequently, please ask help for local distributors.
	Grid Freq Fault	Grid frequency is abnormal, beyond the protection range.	<ul style="list-style-type: none"> The fault will disappear automatically when the grid frequency is back to normal. If fault still occurs continuously and frequently, please ask help for local distributors.

Type of Fault	Name	Description	Recommend Solution
DC Fault	Bus Low Fault	When inverter is running, bus voltage is lower than the normal value beyond the protection range.	<ul style="list-style-type: none"> • Power off, then restart (Ref. Chapter6) • If fault still occurs continuously and frequently, please ask help for local distributors.
	Bus High Volt	Bus voltage is too high and beyond the protection range.	
	Bus Unbalance	Bus voltage unbalanced, beyond the protection range.	
	DC Offset Fault	The DC component of grid-connected current is too high that beyond the reasonable range.	
System Fault	Over Temperature	The temperature of the installation environment is too high or too low, beyond the reasonable range.	<ul style="list-style-type: none"> • Improve or change the installation environment to adjust the inverter installation environment temperature to normal range. • Power off, then restart (Ref. Chapter6) • If fault still occurs continuously and frequently, please ask help for local distributors.
		The temperature of the cooling device is high or low that beyond the protection range.	
		The temperature of the CPU is high that beyond the protection range.	
	Auto Test Fail	Automatic test failed.	<ul style="list-style-type: none"> • Power off the inverter to check the AC connection, then restart. • If fault still occurs continuously and frequently, please ask help for local distributors.
	No Utility	No continuous utility	
	Grid Volt AD	Grid voltage AD value deviation is too high, beyond the protection range.	<ul style="list-style-type: none"> • Power off, then restart (Ref. Chapter6) • If fault still occurs continuously and frequently, please ask help for local distributors.
	Self Lock	Inverter is locked at the waiting interface.	
	Consistent Fault	The detection results of the two CPUs for the same voltage and frequency are different.	
Device Fault	Grounding is abnormal or the ground wire is disconnected.	<ul style="list-style-type: none"> • Check whether the ground wire of the inverter is properly connected and the ground impedance is too high, if it is, make corrections. • Power off, then restart (Ref. Chapter6) • If fault still occurs continuously and frequently, please ask help for local distributors. 	

Type of Fault	Name	Description	Recommend Solution
Inner Warning	Fan Fault	The fan can not work when is started up.	• Check if there is objects which blocking the fan rotation and remove it.
	Eeprom Fault	Eeprom abnormal	<ul style="list-style-type: none"> • Power off, then restart (Ref. Chapter6) • If fault still occurs continuously and frequently, please ask help for local distributors.
	Communication Lose	CPU to Flash abnormal	
		CPU to Eeprom abnormal	
		Main CPU to auxiliary abnormal	
	Main CPU to HMI abnormal		

9. Specifications

PV Input Data	VT-6607005
Max. DC Power (W)	7000
Max. DC Voltage (V)	600
MPPT Voltage Range (V)	70-550
MPPT Full Power Voltage Range (V)	180-550
Rated Input Voltage (V)	360
Start-up Voltage (V)	70
Max. Input Current (A)	14 x 2
Max. Short Current (A)	18 x 2
No. of MPP Tracker / No. of PV String	2/2
Input Connector Type	MC4
AC Output Data	VT-6607005
Max. Output Power (W)	5500
Nominal Output Power (W)	5000
Max. Output Current (A)	24
Nominal Output Voltage (V)	L/N/PE, 220Vac, 230Vac, 240Vac
Grid Voltage Range	180Vac-276Vac (According to local standard)
Nominal Output Frequency (Hz)	50/60
Grid Frequency Range	45~55Hz/54~66Hz (According to local standard)
Output Power Factor	1 default (adjustable from 0.8 leading to 0.8 lagging)
Output Current THD	<3%
Efficiency	VT-6607005
Max. Efficiency	98.20%
Euro Efficiency	97.90%
Protection	VT-6607005
PV Reverse Polarity Protection	YES
PV Insulation Resistance Detection	YES
AC Short Circuit Protection	YES
AC Over Current Protection	YES
AC Over Voltage Protection	YES
Anti-Islanding Protection	YES
Residual Current Detection	YES
Over Temperature Protection	YES
Integrated DC switch	YES
Surge Protection	Integrated (Type III)
General Data	VT-6607005
Dimensions (W x H x D, mm)	358 x 360 x 142
Weight (kg)	10
Protection Degree	IP65
Enclosure Material	Aluminum
Ambient Temperature Range (°C)	-25 ~ +60°C
Humidity Range	0-100%
Topology	Transformerless
Communication Interface	RS485 / WiFi / Wire Ethernet / GPRS (optional)
Cooling Concept	Convection
Noise Emission (db)	<28
Night Power Consumption (W)	<1
Max. Operation Altitude (m)	4000
Certifications and Standards	VT-6607005
EMC Standard	EN/IEC 61000-6-2, EN/IEC 61000-6-3, EN61000-3-2, EN61000-3-3, EN61000-3-11, EN61000-3-12
Safety Standard	IEC 60068, IEE1547, EN62109
Grid-connection	EN50549-1, EN50438, RD 1699, UNE 217001, RD 413, IEC61727, IEC62116, IEC61683, VDE4105, UL1741 VDE0126 AS4777.2 NB/T 32004-2018, UNT C 15-712-1, ABNT NBR 16149, ABNT NBR 16150

INSTRUCTION MANUAL WIFI MODULE FOR SOLAR INVERTER



INTRODUCTION

Thank you for selecting and buying V-TAC Product. V-TAC will serve you the best. Please read these instructions carefully & keep this user manual handy for future reference. If you have any another query, please contact our dealer or local vendor from whom you have purchased the product. They are trained and ready to serve you at the best.



User Manual QR CODE

Please scan the QR code to access the manual in multiple languages.

WARNING

1. Please make sure to turn off the power before starting the installation.
2. Installation must be performed by a qualified electrician.



This marking indicates that this product should not be disposed of with other household wastes.

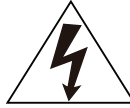

Caution, risk of electric shock.



NOTICE:

Please read this manual carefully before using products and keep it in the place where O&M providers can easily find.

Due to product upgrade and other factors, the content of this manual might change from time to time. Please take actual product as standard and get latest manual from www.vtacexports.com or sales. Unless otherwise agreed herein, this manual will only be used as guidance. Any statement, information or suggestion in this manual will not take any form of responsibility.

Without written permission, any content of this document (partly or entirely) cannot be extracted, copied or transmitted in any form by any company or individual.

DOWNLOAD APP



SOLARMAN Smart
Energy Assistant Around you



SOLARMAN Business
One-Stop O&M, After Service
Management Software

IOS: Search "Solarman Smart" or "Solarman Business" in Apple Store.
Android: Search "Solarman Smart" or "Solarman Business" in Google Play.

1. WIFI MODULE INSTALLATION

Type 1

Step1: Assemble WIFI Module to the inverter communication interface as shown in the diagram.

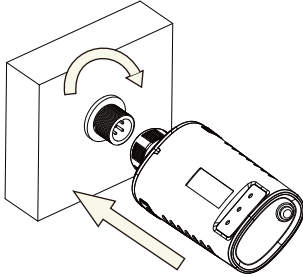

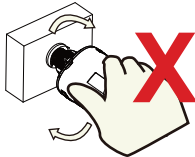

Warning:

Please do not hold the WIFI Module body to rotate while install or remove the Module.



2. WIFI MODULE STATUS

Check Indicator light

Lights	Implication	Status Description(All lights are single green lights.)
	Communication with router	1.Light off: Connection to the router failed. 2.On 1s/Off 1s(Slow flash): Connection to the router succeeded. 3.Light keeps on: Connection to the server succeeded. 4.On 100ms/Off 100ms(Fast flash): Distributing network fast.
	Communication with inverter	1.Light keeps on: WIFI Module connected to the inverter. 2.Light off: Connection to the inverter failed. 3.On 1s/Off 1s(Slow flash): Communicating with inverter.
	WIFI Module running status	1.Light off: Running abnormally. 2.On 1s/Off 1s (Slow flash): Running normally. 3.On 100ms/Off 100ms(Fast flash): Restore factory settings.

The normal operation status of the WIFI Module, when router connected to the network normally:

- 1.Connection to the server succeeded: NET light keeps on after the WIFI Module powered on.
- 2.WIFI Module running normally: READY light flashes.
- 3.Connection to the inverter succeeded: COM light keeps on.

ABNORMAL STATE PROCESSING

If the data on platform is abnormal when the WIFI Module is running, please check the table below and according to the status of indicator lights to complete a simple troubleshooting. If it still can not be resolved or indicator lights status do not show in the table below, please contact Customer Support.

(Note: Please using the following table query after power-on for 2mins at least.)

NET  NET	COM  COM	READY  READY	Fault Description	Fault Cause	Solution
Any state	OFF	Slow flash	Communication with inverter abnormal	1.Connection between WIFI Module and inverter loosen. 2.Inverter does not match with WIFI Module's communication rate.	1.Check the connection between WIFI Module and inverter. Remove the WIFI Module and install again. 2.Check inverter's communication rate to see if it matches with WIFI Module's. 3.Long press Reset button for 5s, reboot WIFI Module.
OFF	ON	Slow flash	Connection between logger and router abnormal	1.WIFI Module does not have a network. 2.Antenna abnormal 3.Router WiFi signal strength weak.	1.Check if the wireless network configured. 2.Check the antenna, if there is any damage or loose. 3.Enhance router WiFi signal strength. 4.Long press Reset button for 10s, reboot WIFI Module and networking again.
Slow flash	ON	Slow flash	Connection between WIFI Module and router normal, connection between logger and remote server abnormal.	1.Router networking abnormal. 2.The server point WIFI of Module is modified. 3.Network limitation, server cannot be connected.	1.Check if the router has access to the network. 2.Check the router's setting, if the connection is limited. 3.Contact our customer service.
OFF	OFF	OFF	Power supply abnormal	1.Connection between WIFI Module & inverter loosen or abnormal. 2.Inverter power - insufficient. 3.WIFI Module - abnormal.	1.Check the connection, remove the WIFI Module and install again. 2.Check inverter output power. 3.Contact our customer service.
Fast flash	Any state	Any state	SMARTLINK networking status	Normal	1.Exit automatically after 5mins. 2.Long press Reset button for 5s, reboot WIFI Module. 3.Long press Reset button for 10s, restore factory settings.
Any state	Any state	Fast flash	Restore factory settings	Normal	1.Exit automatically after 1mins. 2.Long press Reset button for 5s, reboot WIFI Module. 3.Long press Reset button for 10s, restore factory settings.

USAGE METHODS AND NOTICES FOR RESET BUTTON

Usage methods and key-press descriptions for Reset button

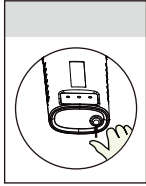

Key-press	Status Description	Light Status
Short press 1s	SMARTLINK rapid networking status.	NET light flashes fast for 100ms.
Long press 5s	Rebooting the WIFI Module.	All lights are extinguished immediately.
Long press 10s	Resetting theWIFI Module.	1.All lights are extinguished after 4s. 2.READY light flashes fast for 100ms.

NOTICES FOR RESET BUTTON



Notice:
Do not remove waterproof plug.



USER MANUAL FOR SOLARMAN SMART APP

1.Registration
Go to Solarman Smart App and register.
Click "Register" and create your account here.

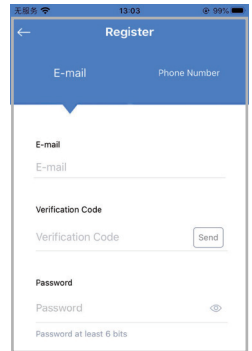
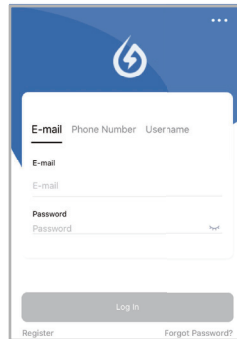

2.Create a Plant
Click "Add Now" to create your plant.
Please fill in plant basic info and other info here.

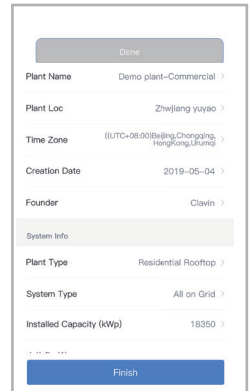
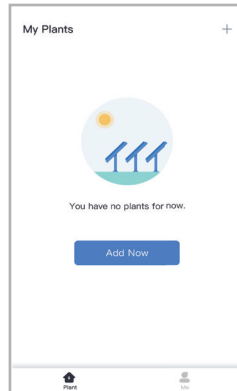

3.Add a Logger

Method 1: Enter logger SN manually.

Method 2: Click the icon in the right and scan to enter logger SN
You can find logger SN in the external packaging or on the logger body.

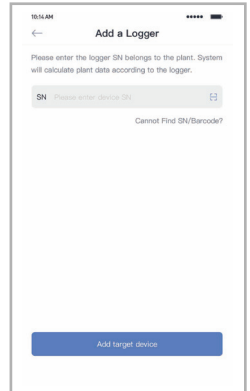
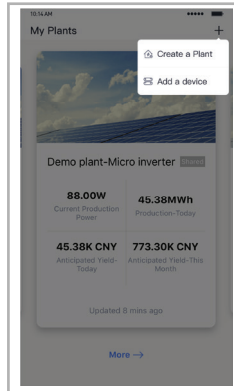

4.Network Configuration

After the logger is added, please configure the network to ensure normal operation.

Go to "Plant Details"->"Device List", find the target SN and click "Networking".

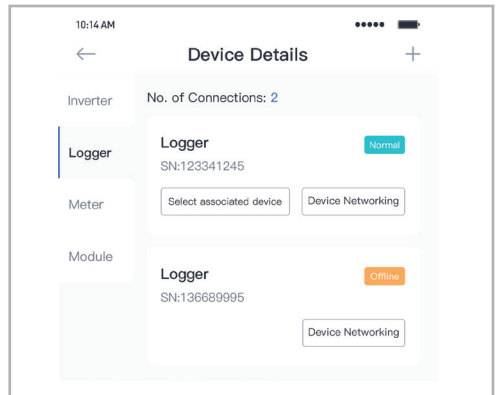

Step 1: Confirm Wi-Fi Info

Please make sure your phone has connected to the right WiFi network. And click "Start".

Notice:

5G WiFi is not supported .

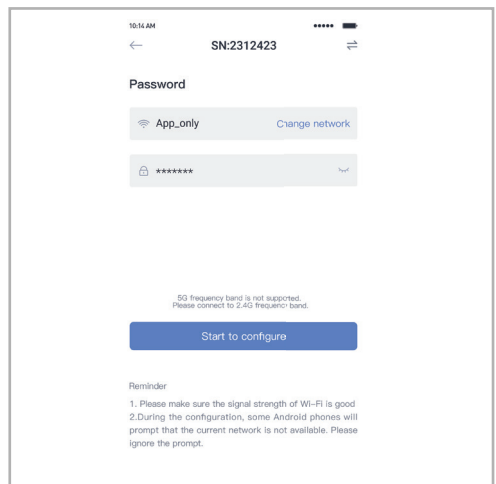

Step 2: Connect to AP network
Click "Go to connect" and find the right "AP_XXXXX" network (XXXXXX Refers to logger SN).

If the password is required, you can find the password on the logger body. Go back to Solarman Smart App, after connecting to AP network.

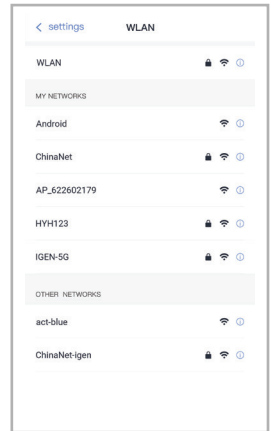
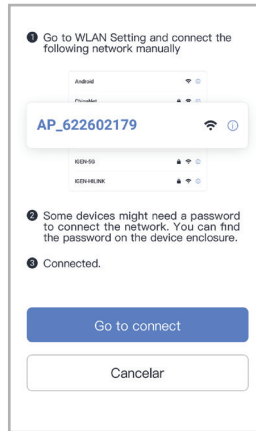

Step 3: Auto Configuration
Please wait for a while to complete the configuration. Then system will switch to the following page.

Click "Done" to check plant data. (Usually, the data will be updated in 10 mins)

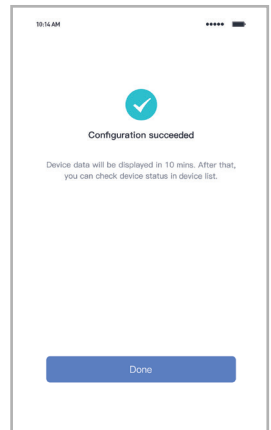
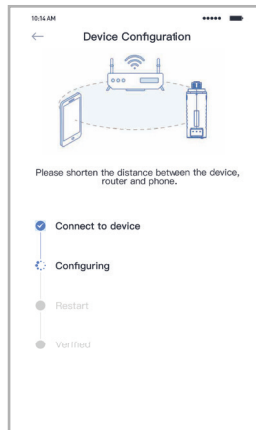

If configuration failure occurs, please check the following reason and try it again.

- (1) Make sure WLAN is ON.
- (2) Make sure WiFi is normal.
- (3) Make sure wireless router does not implement the white-black list.
- (4) Remove the special characters in Wi-Fi network.
- (5) Shorten the distance between the phone and device.
- (6) Try to connect to other Wi-Fi.

Warning:

Please make sure the WIFI Module is working properly before you leave the site. If there is anything abnormal, please do not leave the site and contact customer service: support@v-tac.eu.

1. OVERVIEW

The following picture shows the assignment of the individual connection areas on the bottom of the inverter.

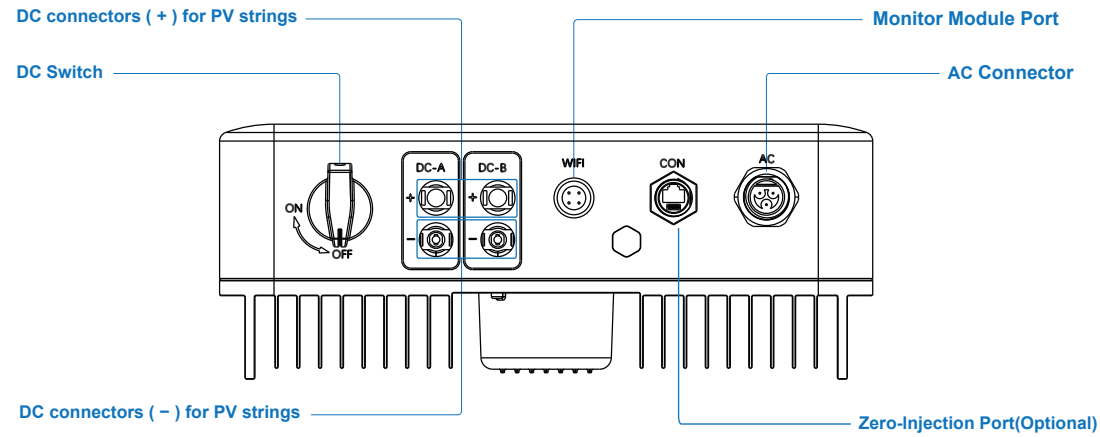

2. PACKAGE LIST

On receiving the inverter, please check to make sure the packing and all components are not missing or damaged. Please contact your dealer directly for supports if there is any damage or missing components.

Open the package, please check the packing list shown as below.

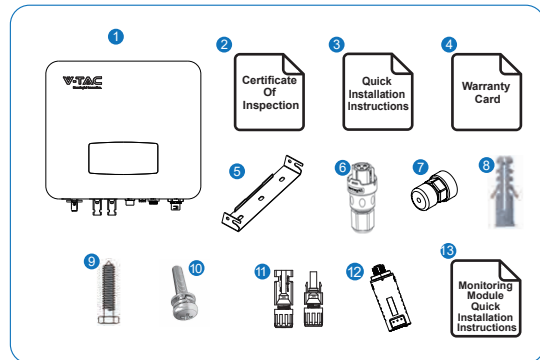

No.	Qty	Items	No.	Qty	Items
1	1	Solar inverter	8	3	Plastic Expansion Tube
2	1	Certificate Of Inspection	9	3	Mounting Bracket Screw
3	1	Quick Installation Instructions	10	1	Security Screw
4	1	Warranty Card	11	2	DC Connector sets
5	1	Wall Mounting Bracket	12	1	Monitor Module
6	1	AC Connector	13	1	Monitoring Module Quick Installation Instructions
7	1	Zero-Injection Connector(Optional)			

3. NOTICE FOR PV

The inverter is equipped with 2 MPPT channels, and Each channel contains a PV string input. For best results, make sure each MPPT channel connect with a PV string separately. Otherwise, the inverter will activate voltage or automatic current protection.

Please follow below picture for correct PV wiring

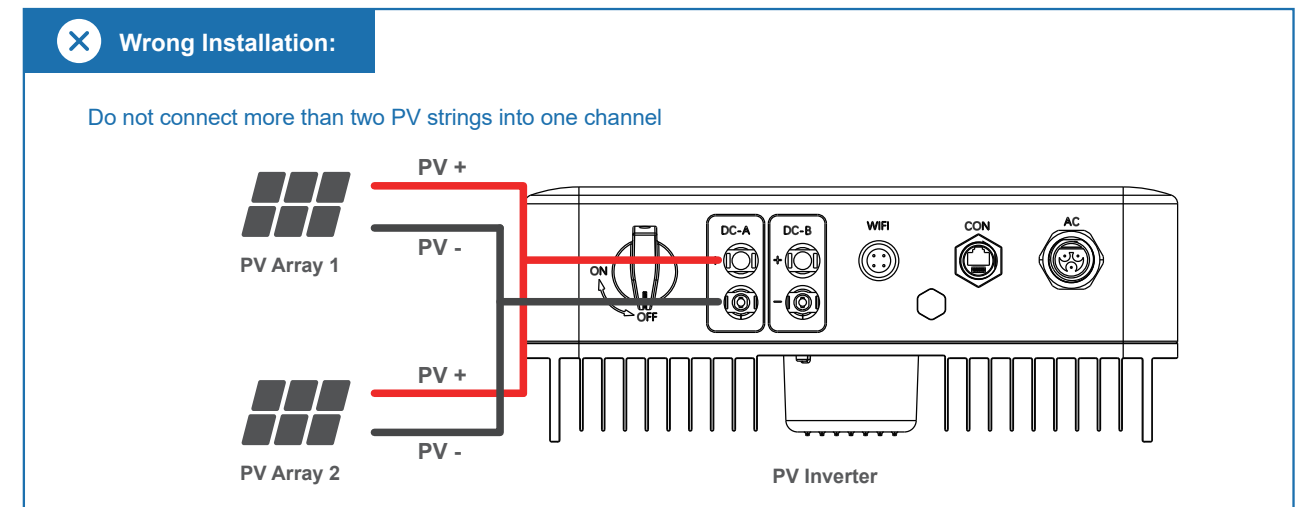
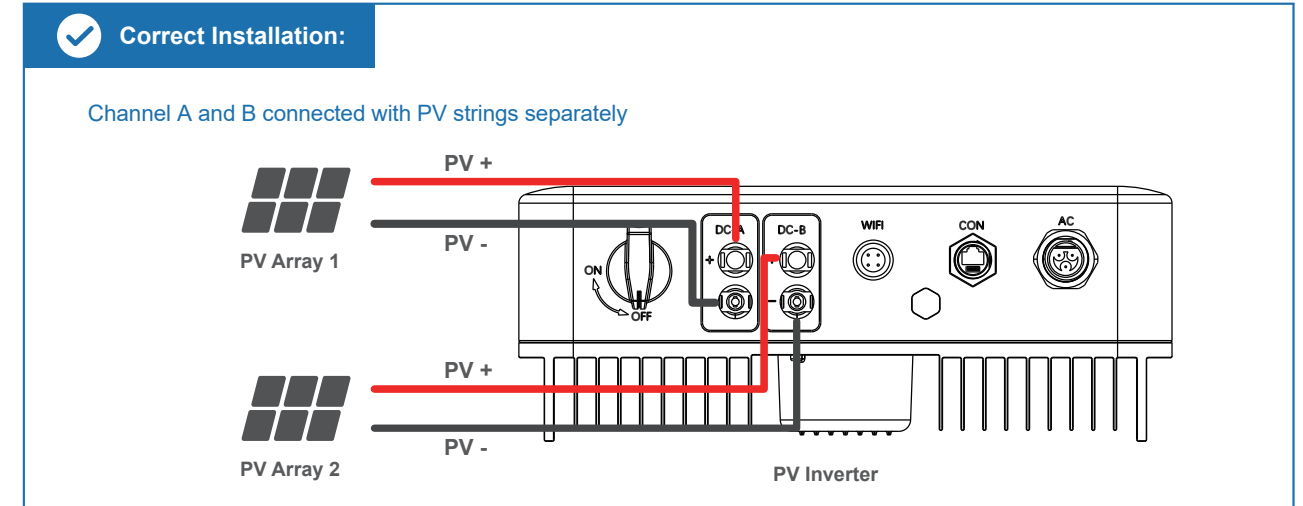

4. QUICK INSTALLATION

A Installation On-grid PV Inverter

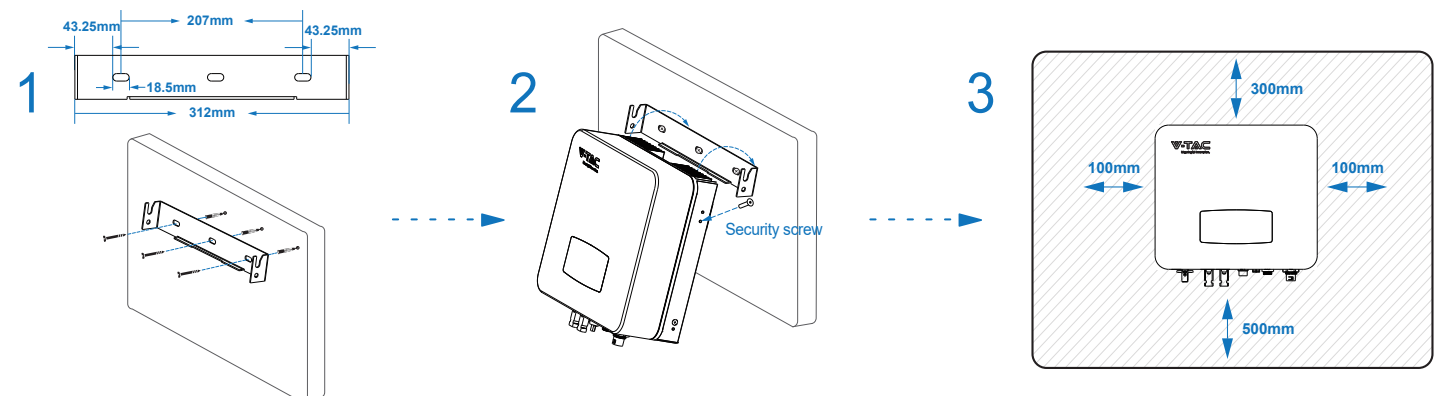

B

PV Connection

1

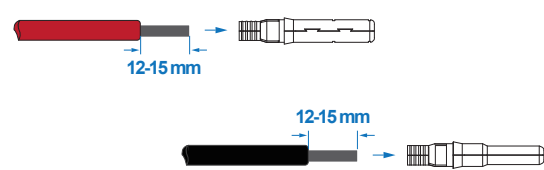

Note:
PV cable suggestion
Cross-section
4 mm²

2

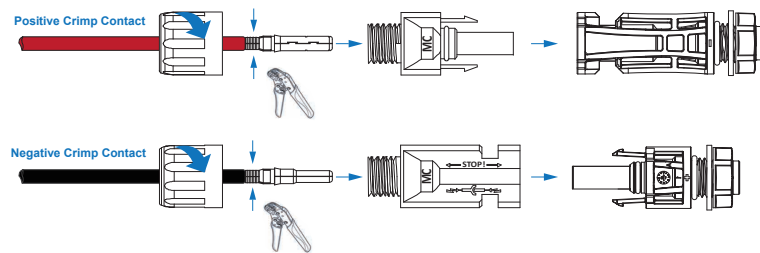

Note:
Please use PV connector crimper
to pinch the point of the arrow

Note:
You'll hear click sound when
the connector assembly is correct

3

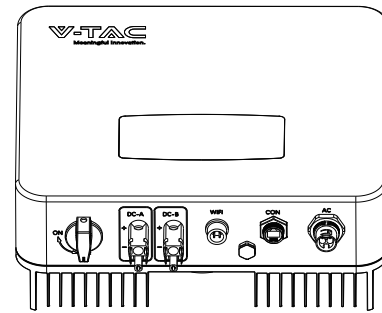

Warning:
The fatal high voltage may on the DC side, please comply with electric safety when connecting.
Please make sure the cable connected in correct polarity with inverter, otherwise inverter could be damaged.

C

Grid Connection

1



Note:
AC cable suggestion
Cross-section
4 mm²

2

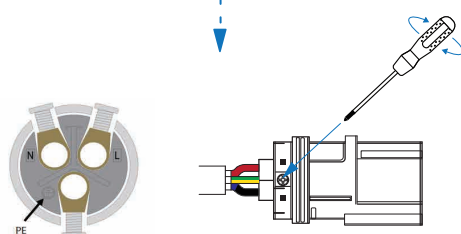

Warning:
The fatal high voltage may on the AC side, please comply with electric safety when connecting.
Please make sure the right line of AC grid connected with inverter, otherwise inverter could be damaged.

3

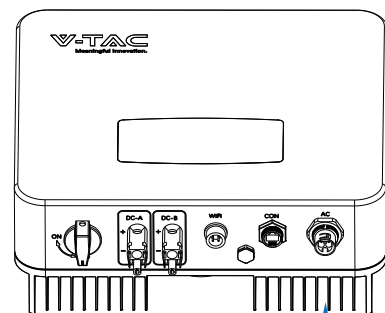

1. Connect AC terminals and waterproof head, tighten the cap, make sure they clip closely together.
2. Connect AC connector to AC terminal of the inverter.
3. After making sure that it is firmly inserted, tighten the sleeve on the AC connector to the right and hear a click.

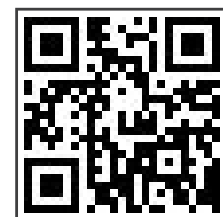

Scan the QR code below to view the user manual

D

WiFi Connection

1

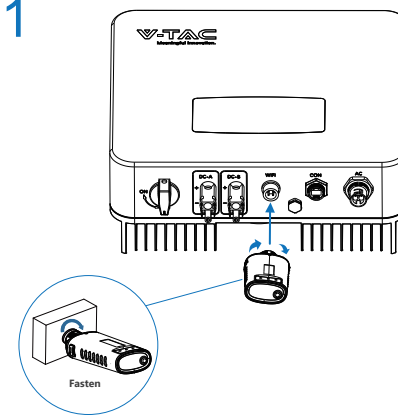

2

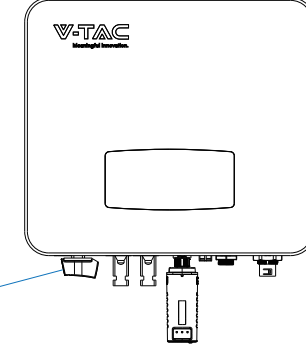

Turn on the DC switch and AC circuit breaker, wait until the LED on the monitoring module flashes.

3



3



Configure the Monitor Module, router, account registration, etc. Please check the WiFi connection manual for details.

Scan code download APP



E

Zero-Injection Connection (Optional)

1

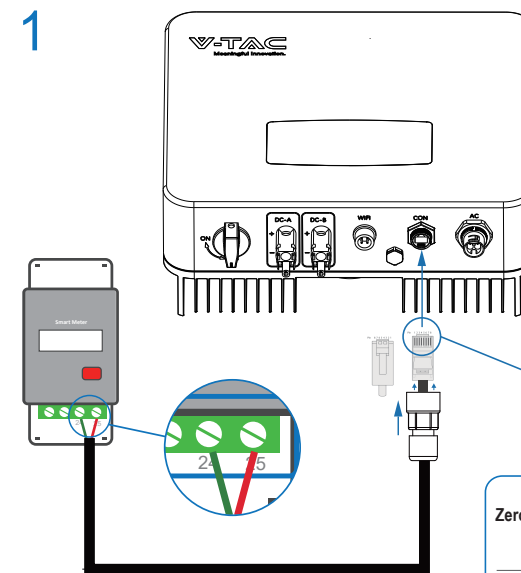

Zero-Injection Port pin assignment	
PIN	Assignment
1-6	/
7	RS485 A (24)
8	RS485 B (25)

Note:
Please follow below pin order
RS485A(Pin 7) to single-phase meter (Pin 24)
RS485B(Pin 8) to single-phase meter (Pin 25)

2

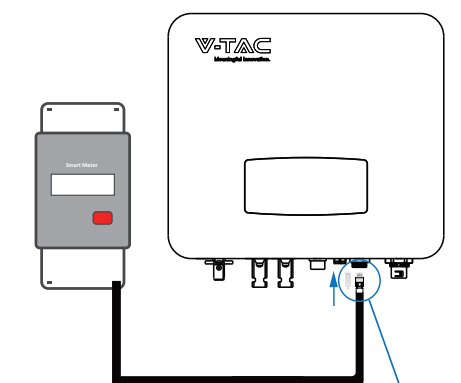

Note:
Please refer to "Zero Injection Smart Meter Installation and Operation Manual" for detailed instruction.