

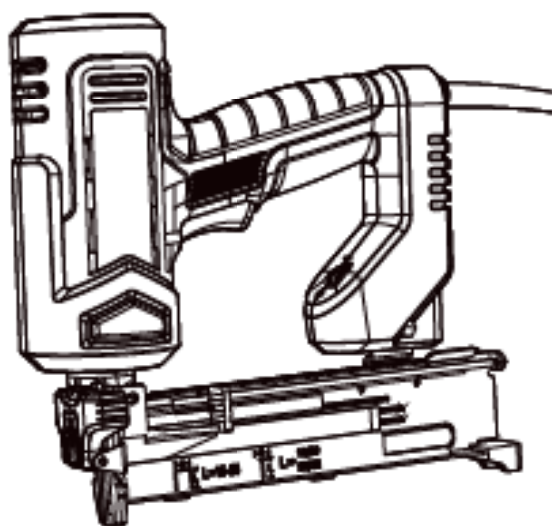

EN

# TITAN

## 32mm Nailer & Stapler



**TTB970NST**  
EAN: 5063022074331

CAUTION: Read the instructions before using the product.



BX220IM

# Let's get started...

These instructions are for your safety. Please read through them thoroughly prior to handling the product and retain them for future reference.



## Getting **started...** 02

<b>Safety information</b>	03
<b>Your product</b>	13
<b>Technical specifications</b>	14
<b>Before you start</b>	15



## **In more detail...** 19

<b>Functions &amp; Settings</b>	20
<b>Operation</b>	21
<b>Care and maintenance</b>	24
<b>Troubleshooting</b>	28
<b>Recycling and disposal</b>	29
<b>Guarantee</b>	30
<b>Declaration of conformity</b>	31

## Safety warnings

### General power tool safety warnings



**WARNING!** Read all safety warnings, instructions, illustrations and specifications provided with this power tool. *Failure to follow all instructions listed below may result in electric shock, fire and/or serious injury.*

**Save all warnings and instructions for future reference.**

*The term "power tool" in the warnings refers to your mains-operated (corded) power tool or battery-operated (cordless) power tool.*

### Work area safety

- Keep work area clean and well lit.** *Cluttered or dark areas invite accidents.*
- Do not operate power tools in explosive atmospheres, such as in the presence of flammable liquids, gases or dust.** *Power tools create sparks which may ignite the dust or fumes.*
- Keep children and bystanders away while operating a power tool.** *Distractions can cause you to lose control.*

### Electrical safety

- Power tool plugs must match the outlet. Never modify the plug in any way. Do not use any adapter plugs with earthed (grounded) power tools.** *Unmodified plugs and matching outlets will reduce risk of electric shock.*

## Safety warnings

- b) **Avoid body contact with earthed or grounded surfaces, such as pipes, radiators, ranges and refrigerators.** *There is an increased risk of electric shock if your body is earthed or grounded.*
- c) **Do not expose power tools to rain or wet conditions.** *Water entering a power tool will increase the risk of electric shock.*
- d) **Do not abuse the cord. Never use the cord for carrying, pulling or unplugging the power tool. Keep cord away from heat, oil, sharp edges or moving parts.** *Damaged or entangled cords increase the risk of electric shock.*
- e) **When operating a power tool outdoors, use an extension cord suitable for outdoor use.** *Use of a cord suitable for outdoor use reduces the risk of electric shock.*
- f) **If operating a power tool in a damp location is unavoidable, use a residual current device (RCD) protected supply.** *Use of an RCD reduces the risk of electric shock.*

### Personal safety

- a) **Stay alert, watch what you are doing and use common sense when operating a power tool. Do not use a power tool while you are tired or under the influence of drugs, alcohol or medication.** *A moment of inattention while operating power tools may result in serious personal injury.*
- b) **Use personal protective equipment. Always wear eye protection.** *Protective equipment such as dust mask, non-skid safety shoes, hard hat, or hearing protection used for appropriate conditions will reduce personal injuries.*

- c) **Prevent unintentional starting. Ensure the switch is in the off-position before connecting to power source, picking up or carrying the tool.** *Carrying power tools with your finger on the switch or energising power tools that have the switch on invites accidents.*
- d) **Remove any adjusting key or wrench before turning the power tool on.** *A wrench or a key left attached to a rotating part of the power tool may result in personal injury.*
- e) **Do not overreach. Keep proper footing and balance at all times.** *This enables better control of the power tool in unexpected situations.*
- f) **Dress properly. Do not wear loose clothing or jewellery. Keep your hair and clothing away from moving parts.** *Loose clothes, jewellery or long hair can be caught in moving parts.*
- g) **If devices are provided for the connection of dust extraction and collection facilities, ensure these are connected and properly used.** *Use of dust collection can reduce dust-related hazards.*
- h) **Do not let familiarity gained from frequent use of tools allow you to become complacent and ignore tool safety principles.** *A careless action can cause severe injury within a fraction of a second.*

### Power tool use and care

- a) **Do not force the power tool. Use the correct power tool for your application.** *The correct power tool will do the job better and safer at the rate for which it was designed.*
- b) **Do not use the power tool if the switch does not turn it on and off.** *Any power tool that cannot be controlled with the switch is dangerous and must be repaired.*

## Safety warnings

- c) **Disconnect the plug from the power source and/ or remove the battery pack, if detachable, from the power tool before making any adjustments, changing accessories, or storing power tools.** *Such preventive safety measures reduce the risk of starting the power tool accidentally.*
- d) **Store idle power tools out of the reach of children and do not allow persons unfamiliar with the power tool or these instructions to operate the power tool.** *Power tools are dangerous in the hands of untrained users.*
- e) **Maintain power tools and accessories. Check for misalignment or binding of moving parts, breakage of parts and any other condition that may affect the power tool's operation. If damaged, have the power tool repaired before use.** *Many accidents are caused by poorly maintained power tools.*
- f) **Keep cutting tools sharp and clean.** *Properly maintained cutting tools with sharp cutting edges are less likely to bind and are easier to control.*
- g) **Use the power tool, accessories and tool bits etc. in accordance with these instructions, taking into account the working conditions and the work to be performed.** *Use of the power tool for operations different from those intended could result in a hazardous situation.*
- h) **Keep handles and grasping surfaces dry, clean and free from oil and grease.** *Slippery handles and grasping surfaces do not allow for safe handling and control of the tool in unexpected situations.*

## Service

- a) **Have your power tools serviced by a qualified repair person using only identical replacement parts.** *This will ensure that safety of the power tool is maintained.*

## Nailer / Stapler safety warnings

- a) **Always assume that the tool contains fasteners.** *Careless handling of the nailer / stapler can result in unexpected firing of fasteners and personal injury.*
- b) **Do not point the tool towards yourself or anyone nearby.** *Unexpected triggering will discharge the fastener causing an injury.*
- c) **Do not actuate the tool unless the tool is placed firmly against the workpiece.** *If the tool is not in contact with the workpiece, the fastener may be deflected away from your target.*
- d) **Disconnect the tool from the power source when the fastener jams in the tool.** *While removing a jammed fastener, the nailer / stapler may be accidentally activated if it is plugged in.*
- e) **Use caution while removing a jammed fastener.** *The mechanism may be under compression and the fastener may be forcefully discharged while attempting to free a jammed condition.*
- f) **Do not use this nailer / stapler for fastening electrical cables.** *It is not designed for electric cable installation and may damage the insulation of electric cables thereby causing electric shock or fire hazards.*
- g) **Use suitable detectors to determine if there are hidden supply lines or contact the local utility company for assistance.** *Contact with electric cables can cause fire and electric shock. Damaging gas lines can lead to explosion. Breaking water pipes causes property damage.*

## Safety warnings

- h) Before use, check the supply and extension cord for signs of damage or aging. If the cord becomes damaged during use, disconnect the cord from the supply immediately. **DO NOT TOUCH THE CORD BEFORE DISCONNECTING THE SUPPLY.** Do not use the product if the cord is damaged or worn.
- i) Keep the supply and extension cord away from the nailer head (10).
- j) Hold the product only by the handle grip (3) and ensure that the trigger (2) is not pressed down in the work area.
- k) Consider the space that is available in the work area. Nails or staples may penetrate thin workpieces or slide off workpieces during work on corners and edges, thus endangering person.
- l) Read the instructions carefully. Be familiar with the controls and the correct use of the product.
- m) Use the product only in daylight or good artificial light.
- n) Never allow children or people unfamiliar with these instructions to use the product. Local regulations can restrict the age of the operator.
- o) Keep in mind that the operator or user is responsible for accidents or hazards occurring to other people or their property.
- p) Keep the area clear of all bystanders, children, and pets while operating the product.
- q) Disconnect the plug from the power supply before carrying out maintenance or cleaning work.
- r) Use only the manufacturer's recommended accessories.
- s) Inspect and maintain the product regularly. Have the product repaired only by an authorized repairer.



- t) When not in use, store the product out of the reach of children.
- u) If the replacement of the supply cord is necessary, this has to be done by the manufacturer or his agent in order to avoid a safety hazard.
- v) Store the product in a location where the ambient temperature is between 0°C and 40°C.

### Health surveillance

All employees should be part of an employer's health surveillance scheme to help identify any vibration related diseases at an early stage, prevent disease progression and help employees stay in work.

### Vibration and noise reduction

**To reduce the impact of noise and vibration emission, limit the time of operation, use low-vibration and low-noise operating modes as well as wear personal protective equipment.**

Take the following points into account to minimise the vibration and noise exposure risks:

1. Only use the product as intended by its design and these instructions.
2. Ensure that the product is in good condition and well maintained.
3. Use correct attachments for the product and ensure they are in good condition.
4. Keep tight grip on the handles/grip surface.
5. Maintain this product in accordance with these instructions and keep it well lubricated (where appropriate).
6. Plan your work schedule to spread any high vibration tool use across a longer period of time.

## Safety warnings

7. Prolonged use of the product exposes the user to vibrations that can cause a range of conditions collectively known as hand-arm vibration syndrome (HAVS) e.g. fingers going white; as well as specific diseases such as carpal tunnel syndrome. To reduce this risk when using the product, always wear protective gloves and keep your hands warm.

### Emergency

**Familiarise yourself with the use of this product by means of this instruction manual. Memorise the safety directions and follow them to the letter. This will help to prevent risks and hazards.**

1. **Always be alert when using this product, so that you can recognise and handle risks early.** *Fast intervention can prevent serious injury and damage to property.*
2. **Switch the product off and disconnect from the power supply if there are malfunctions.** *Have the product checked by a qualified professional and repaired, if necessary, before you operate it again.*

### Residual risks

**Even if you are operating this product in accordance with all the safety requirements, potential risks of injury and damage remain. The following dangers can arise in connection with the structure and design of this product:**

1. Crushing hazard.
2. Risk of injury by nails or staples.
3. Ear damage if working without ear protection.
4. Health defects resulting from vibration emission if the product is being used over long periods of time or not adequately managed and properly maintained.



5. Injuries and damage to property due to broken attachments or the sudden impact of hidden objects during use.



**WARNING!** This product produces an electromagnetic field during operation! This field may under some circumstances interfere with active or passive medical implants! To reduce the risk of serious or fatal injury, we recommend persons with medical implants to consult their doctor and the medical implant manufacturer before operating this product!



**WARNING!** This machine meets the requirements of EN IEC 61000-3-11: 2019 and is subject to special connection conditions. That means that its use at freely selectable connection points is not permitted. If the network conditions are unfavourable, the device may result in temporary voltage fluctuations. The maximum permissible mains impedance at the electrical connection is 0.5367  $\Omega$ . As the user, you must ensure in consultation with your electricity supply company if necessary- that the continuous current carrying capacity of the network at the connection point to the public mains is sufficient for the connection of the machine.



















Getting started...

## Symbols

On the product, the rating label and within these instructions you will find among others the following symbols and abbreviations. Familiarise yourself with them to reduce hazards like personal injuries and damage to property.

V ~	Volt, (alternating voltage)	A	Ampere
/min or min <sup>-1</sup>	Per minute	Hz	Hertz
g	Gram	kg	Kilogram

## Symbols

mm	Millimetre	m	Metre
dB(A)	Decibel (A-rated)	m/s <sup>2</sup>	Metres per second squared
	Lock / to tighten or secure.		Unlock / to loosen.
	Read the instruction manual.		Note / Remark.
			Caution / Warning.
yyWxx	Manufacturing date code; year of manufacturing (20yy) and week of manufacturing (Wxx)		
	Always wear hearing protection.		Always wear eye protection.
	Wear a dust mask.		Wear protective gloves.
	Wear protective, slip-resistant footwear.		
	Switch the product off and disconnect it from the power supply before assembly, cleaning, adjustments, maintenance, storage and transportation.		
	This product is of protection class <b>II</b> . That means it is equipped with enhanced or double insulation.		
	Do not expose the product to rain or wet conditions (moisture).		
	To prevent serious injury, keep your hands away from the nailer head (10)		
	Ejected nails/staples by the product could hit the user or other bystanders. Always ensure that other people and pets remain at a safe distance from the product when it is in operation. In general, children must not come near the area where the product is. Minimum distance is 10 m.		
	Remove the plug from the mains immediately if the cable is damaged or cut.		
	WEEE symbol. Waste electrical products should not be disposed of with household waste. Please recycle where facilities exist. Check with your Local Authority or local store for recycling advice.		
	The product complies with the applicable European directives and an evaluation method of conformity for these directives was done.		



UK Conformity Assessed.

## Rating label explanation

### Model number: TTB970NST

TT = TITAN (brand)

B = Voltage (230-240 V~)

970 = Sequential code

NST = Nailer / Stapler

## Product description

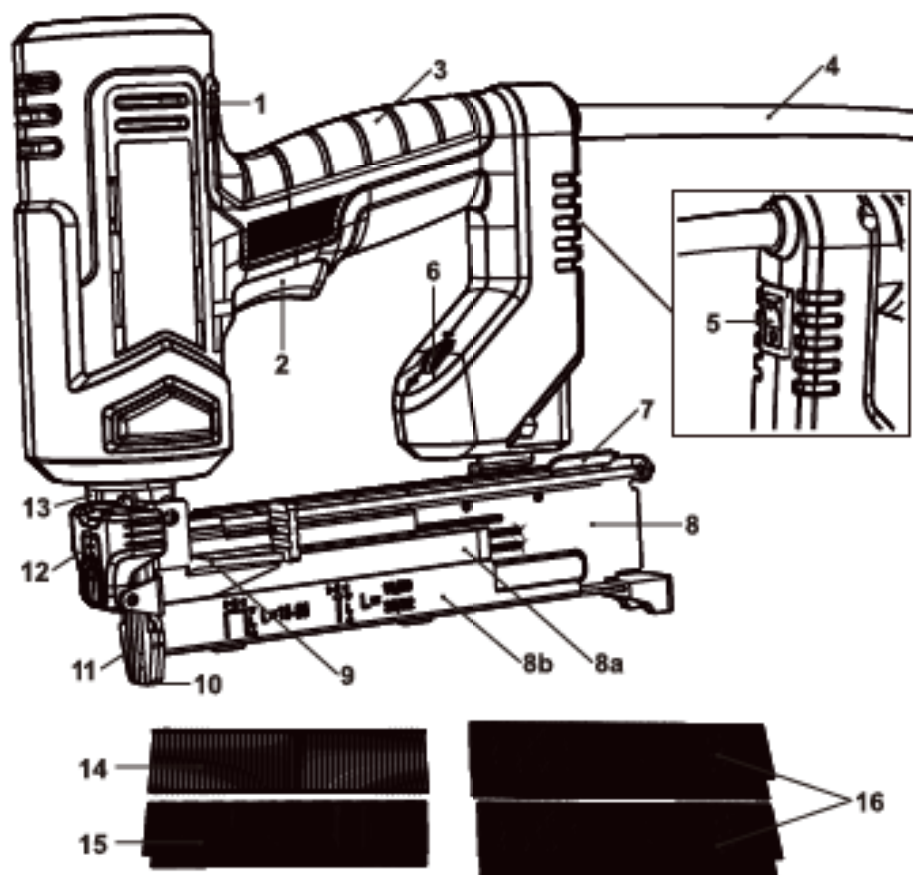

Getting started...

## Product description

- |                         |                      |   |
|-------------------------|----------------------|---|
| 1. Air vents            | 8. Magazine          | 13. Stopper                               |
| 2. Trigger              | a) Inner barrier     | 14. Nail strip (32mm x 100Nails) (x1)     |
| 3. Hand grip            | b) Outer barrier     | 15. Staple strip (20mm x 100Staples) (x1) |
| 4. Power cord with plug | 9. Fastener Retainer | 16. Staple strip (25mm x 100Staples) (x2) |
| 5. On/off switch        | 10. Nailer head      |   |
| 6. Impact force control | 11. Safety yoke      |   |
| 7. Retainer holder      | 12. Clamping knob    |   |

## Technical specifications

### General

- > **Rated voltage, frequency** : 230-240 V ~, 50 Hz
- > **Rated current** : 8 A
- > **Max shots** : 30 min<sup>-1</sup>
- > **Magazine volume** : Up to 100 nails/staples
- > **Degree of protection** : IPX0
- > **Protection class** : 
- > **Weight** : approx. 1.45 kg
- > **Dimensions** : approx. 232\*211\*70 mm

### Nail strip

- > **Type** : 18Ga Brad nails
- > **Size** : A = 15 / 20 / 25 / 32 mm  
B = 1,25 mm  
C = 2 mm



### Staple strip

- > **Type** : 18Ga Narrow Crown Staples
- > **Size** : A = 15-25 mm  
B = 6 mm  
C = 0,8 mm  
D = 1.1 mm



### Sound values

- > **Sound pressure level  $L_{pA}$**  : 95,3 dB(A)
- > **Uncertainty  $K_{pA}$**  : 3 dB(A)
- > **Measured sound power level  $L_{WA}$**  : 106,3 dB(A)
- > **Uncertainty  $K_{WA}$**  : 3 dB(A)

### Hand arm vibration values

- > **Handle  $a_{h,w}$**  : 5,312 m/s<sup>2</sup>
- > **Uncertainty K** : 1,5 m/s<sup>2</sup>

The sound value(s) have been determined according to noise test code given in EN 60745-2-16, using the basic standards EN ISO 11203 and EN ISO 3744. The sound intensity level for the operator may exceed 80 dB(A) and ear protection measures are necessary.

The declared total vibration value(s) and the declared noise emission value(s) have been measured in accordance with a standard test method and may be used for comparing one tool with another;

The declared total vibration value(s) and the declared noise emission value(s) may also be used in a preliminary assessment of exposure.



**WARNING!** The vibration and noise emission during actual use of the power tool can differ from the declared total value depending on the ways in which the tool is used especially what kind of workpiece is processed;

The need to identify safety measures to protect the operator that are based on an estimation of exposure in the actual conditions of use (taking account of all parts of the operating cycle such as the times when the tool is switched off and when it is running idle in addition to the trigger time).

## Unpacking

1. Unpack all parts and lay them on a flat, stable surface.
2. Remove all packing materials and shipping devices if applicable.
3. Make sure the delivery contents are complete and free of any damage. If you find that parts are missing or show damage do not use the product but contact your dealer. Using an incomplete or damaged product represents a hazard to people and property.
4. Ensure that you have all the accessories and tools needed for assembly and operation. This also includes suitable personal protective equipment.



**WARNING!** The product and the packaging are not children's toys! Children must not play with plastic bags, sheets and small parts! There is a danger of choking and suffocation!

## You will need

(items not supplied)

Suitable personal protective equipment

(items supplied)

Nail strip (32 mm x 100 Nails) (14)

Staple strip (20 mm x 100 Staples) (15)

Staple strip (25 mm x 100 Staples) (16)

## You will need



**NOTE:** The accessories required depend on the intended application. Ask your dealer for advice.

## Assembly



**WARNING!** Before using the product, familiarise yourself with the operating features read the entire instruction manual paying particular attention to the safety rules and operating procedures.



Do not connect the product to power supply before it is completely assembled.



## Nails/staples



**WARNING!** Only original nails/staples that match to the precision parts of the nailer/stapler such as the magazine (8), the striker and the nailer head (10) can be used.

Other manufacturers use different steel grades and sizes, which may damage the nailer/stapler.

Select the appropriate size of the nails/staples as shown in Fig. 1:



Fig. 1

## Loading the magazine

1. Lay the nailer/stapler down on a stable, level surface.
2. Pull the fastener retainer (9) out of the back of the nailer/stapler until it stops (Fig. 2, step 1).
3. Hold the fastener retainer (9) and rotate it 90° clockwise. Before releasing, ensure that its slot engages in the retainer holder (7) (Fig. 2, step 2).



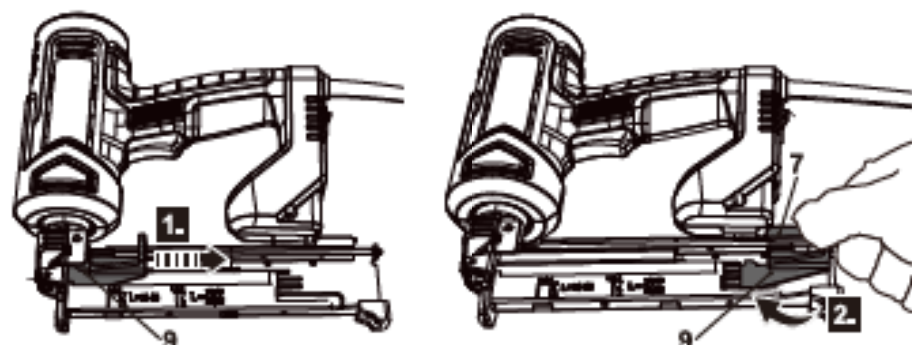

Fig. 2

4. Fill the magazine (8) with the required nail strip (14) or staple strip (15 / 16) (Fig. 3). Ensure that the nail or staple tips are pointing towards the base of the product.



**WARNING!** Make sure to place the nail strip (14) under the inner barrier (8a), not between the inner barrier (8a) and the outer barrier (8b). Make sure to slide the staple strip (15 / 16) upon the inner barrier (8a), not upon the outer barrier (8b).

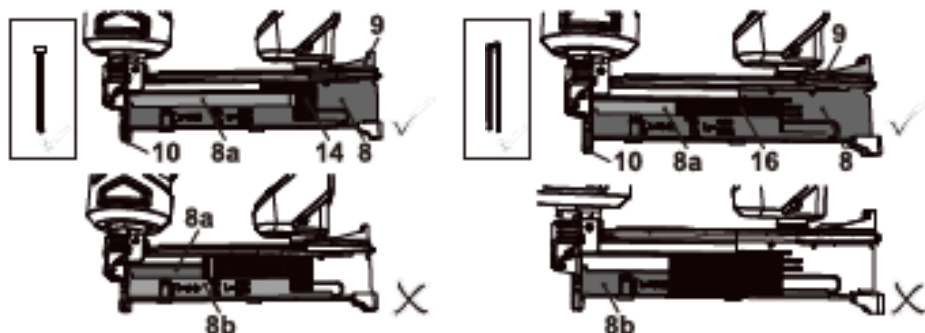

Fig. 3

5. After loading, rotate the fastener retainer (9) back to its original position, and the fastener retainer (9) will automatically push the nails/staples against the nailer head (10).



**WARNING!** Don't load nails/staples of different lengths into the magazine (8) at the same time. Don't mix nails and staples in the magazine (8). When opening, loading or closing the magazine (8), the retraction force of the fastener retainer (9) may cause a squeezing hazard if your hand slides.

## Connection to power supply

1. Make sure the on/off switch (5) is in its OFF position.
2. Connect the plug of the power cord with a suitable power socket.



**WARNING!** Check the voltage! The voltage must comply with the information on the rating label!

3. Your product is now ready to be used.



## In more detail...

<b>Functions &amp; settings</b>	20
<b>Operation</b>	21
<b>Care and maintenance</b>	24
<b>Troubleshooting</b>	28
<b>Recycling and disposal</b>	29
<b>Guarantee</b>	30
<b>Declaration of conformity</b>	31

In more detail...



## Intended use

This electric nailer/stapler TTB970NST is designated with a rated input of 8 A. The product is intended for nailing/stapling fabrics, leather, cardboard, foils, insulation material and similar materials to a soft surface, such as wood or wood-like materials. The product is not suitable for fastening wall or ceiling panelling. Do not use the product for any other purpose.

For safety reasons it is essential to read the entire instruction manual before first operation and to observe all the instructions therein.

This product is intended for private domestic use only, not for any commercial trade use. It must not be used for any purposes other than those described.

## On/off Switch

1. Switch the product on by pressing the on/off switch (5) at "I" marking (Fig. 4).
2. Switch the product off by pressing the on/off switch (5) at "O" marking.

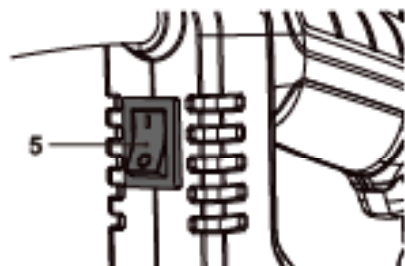

Fig. 4

## Impact force control



**WARNING!** Select the lowest impact force sufficient for nailing/stapling. Take into account the length of the nails/staples you are using as well as hardness of the material you are working with. Before starting a job, find the optimal impact force by testing out on spare material.

1. Turn the impact force control (6) downward to increase the impact force (Fig. 5).
2. Turn the impact force control (6) upward to decrease the impact force.

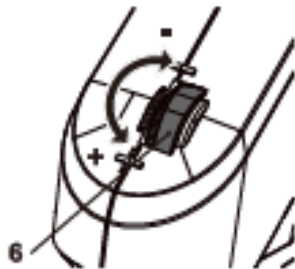

Fig. 5

## Trigger and firing

Follow the below steps for firing:

1. Press the safety yoke (11) onto the material/workpiece that you want to nail/staple (Fig. 6, step 1).
2. Maintain the contact pressure and briefly press the trigger (2) (Fig. 6, step 2). The firing will be performed.

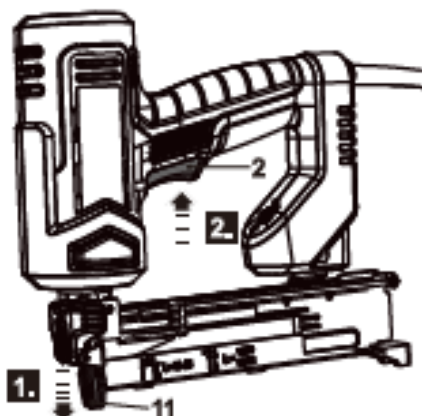

Fig. 6



**WARNING!** The firing can't be performed in reverse order.

## General operation

1. Check the product, its power cord and plug as well as accessories for damage before each use. Do not use the product if it is damaged or shows wear. Take care of any problem you find or have the product checked by qualified specialist.
2. Double check that the accessories and attachments are properly fixed.
3. Always hold the product on the handle grip (3). Keep the handle dry to ensure safe operation.
4. Ensure that the air vents (1) are always unobstructed and clear. Clean them if necessary with a soft brush. Blocked air vents may lead to overheating and damage the product.
5. Keep the supply and extension cord away from the nailer head (10).
6. Switch the product off immediately if you are disturbed while working by other people entering the working area.
7. Do not overwork yourself. Take regular breaks to ensure you can concentrate on the work and have full control over the product.
8. While working, ensure that the product does not strike hard objects, as this can cause damage.

In more detail...

## Checking



**NOTE:** Before operating the product, perform the following tests to check the function of the safety yoke (11) and the trigger (2).

1. Remove the nails/staples out of the magazine (8).
2. Switch on the product after connecting with the power supply.
3. Press the safety yoke (11) on a piece of scrap soft wood, then squeeze the trigger (2) for firing. The safety yoke (11) and the trigger (2) should move smoothly. The firing should be performed.
4. If any malfunctions occur stop using the product immediately and return to the dealer.



Fig. 7



**NOTE:** The nail/staple is ejected from the nailer head (10). Make several trials to nail/staple at your desired position (Fig. 7).

## Firing

1. Switch on the product after connecting with the power supply.
2. Insert a required nail strip / staple strip (14 / 16) in the magazine (8).
3. Turn the impact force control (6) to a suitable setting.
4. Ensure that no people or animals are in the work area.
5. Hold the product firmly on the handle grip (3) with one hand. Always keep your hand away from the nailer head (10).
6. Press the safety yoke (11) onto the material/workpiece that you want to nail/staple (Fig. 8, step 1).
7. Maintain the contact pressure and briefly press the trigger (2) (Fig. 8, step 2).
8. Once the nail/staple from the nailer head (10) has been completely driven in, release the trigger (2) and lift the safety yoke (11) from the workpiece (Fig. 8, step 3). Never fire again at the same spot.
9. Repeat step 1 to step 3 for performing more firings.

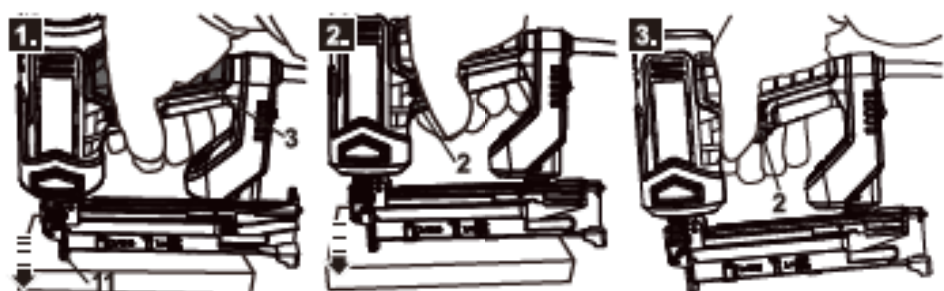

Fig. 8



**NOTE:** The safety yoke (11) should be pressed before squeezing the trigger (2). Carefully set the safety yoke (11) down on the material. Soft workpieces (e.g. pine wood) could be damaged if you press down too hard.



**WARNING!** Wear safety gloves when working on the nails/staples and close to them!



Nails/Staples may penetrate thin workpieces or slide off workpieces during work on corners and edges, thus endangering person.



To prevent serious injury, keep your hands away from the nailer head (10)!



Disconnect the plug from the power supply while loading the magazine or conducting any intermediate checks.

Use appropriate tools to remove debris, e. g. a brush! Never use your bare hands!

In more detail...

## After use

1. Switch the product off, disconnect it from the power supply and let it cool down.
2. Remove the nails/staples out from the magazine (8).
3. Check, clean and store the product as described below.

## The golden rules for care



**WARNING!** Always switch the product off, disconnect the product from the power supply and let the product cool down before performing inspection, maintenance and cleaning work!

1. Keep the product clean. Remove debris from it after each use and before storage.
2. Regular and proper cleaning will help ensure safe use and prolong the life of the product.
3. Inspect the product before each use for worn and damaged parts. Do not operate it if you find broken and worn parts.



**WARNING!** Only perform repairs and maintenance work according to these instructions! All further works must be performed by a qualified specialist!

## General cleaning

1. Clean the product with a damp cloth and pH-neutral soap. Use a brush for areas that are hard to reach.
2. In particular clean the air vents (1) after every use with a cloth and brush.
3. Remove stubborn dust with high pressure air (max. 3 bar).



**NOTE:** Do not use chemical, alkaline, abrasive or other aggressive detergents or disinfectants to clean this product as they might be harmful to its surfaces.

4. Check for any damage and wear. Repair damages in accordance with this instruction manual or take it to an authorised service centre before using the product again.

## Maintenance

Before and after each use, check the product and accessories (or attachments) for wear and damage. If required, exchange them for new ones as described in this instruction manual. Observe the technical requirements.



## Removing jams



**WARNING!** Wear safety gloves when working on the nails/staples and close to them!

Use proper tools to remove jammed nail! Never use your bare hands! The jammed nail should be removed before being put back into use, otherwise the mechanical device will be permanently damaged.

If a nail/staple is caught in the magazine or unit, please proceed as follows:

1. Disconnect the plug from the power supply.
2. Pull back the fastener retainer (9) and rotate it 90° clockwise. Before releasing, ensure that its slot engages in the retainer holder (7) (Fig. 9).
3. Remove all nails/staples in the magazine (8).
4. Rotate the clamping knob (12) outward to release the safety yoke (11) (Fig. 10, step 1).

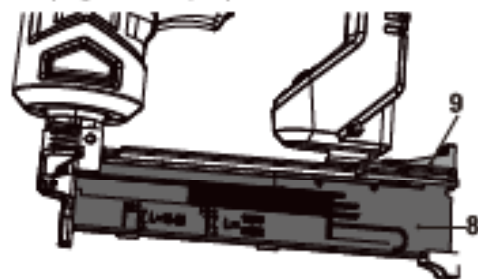

Fig. 9



Fig. 10

5. Remove the jammed nail/staple again with a suitable pliers (not supplied) (Fig. 10, step 2).
6. Secure the safety yoke (11) by rotating the clamping knob (12) inward (Fig. 10, step 3).
7. Ensure that the stopper (13) is not obstructed by the clamping knob (12) when pressing the safety yoke (11) (Fig. 11). Otherwise the built-in switch can't be activated.

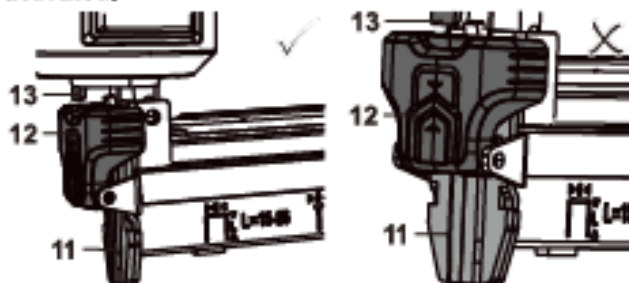

Fig. 11

In more detail...

## Maintenance

- Empty the magazine (8) and switch on the product after connecting with the power supply, attempting to fire 3-4 times on a piece of scrap soft wood (Fig. 12).
- Load the magazine (8) with the nail strip / staple strip (14 / 16) and attempt to fire 3-4 times on a piece of scrap soft wood.
- If any malfunctions occur stop using the product immediately and return to the dealer.

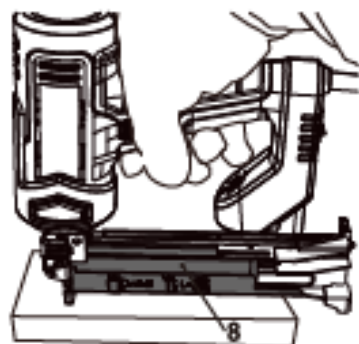

Fig. 12

## Power cord

If the power cord is damaged, it must be replaced by the manufacturer, its service agent or similarly qualified persons in order to avoid a safety hazard.

## UK plug (for UK only)

If you need to replace the fitted plug, then follow the instructions below.

**IMPORTANT:** The wires in the mains lead are coloured in accordance with the following code:

Blue – Neutral

Brown – Live

As the colours of the wire in the mains lead of this product may not correspond with the coloured marking identifying the terminals in your plug, proceed as follows. The wire, which is coloured blue, must be connected to the terminal, which is marked with N or coloured black. The wire, which is coloured brown, must be connected to the terminal, which is marked L or coloured red.

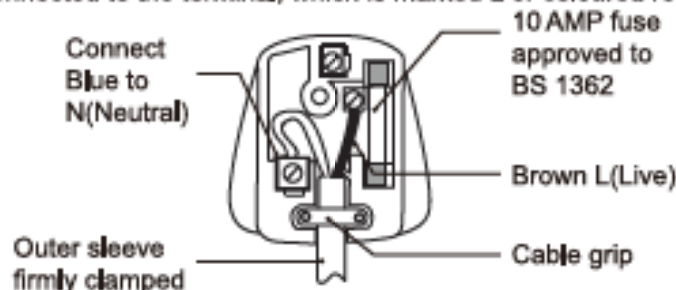



**WARNING!** Never connect live or neutral wires to the earth terminal of the plug, which is marked with E.

Only fit an approved 10 Amp BS 1363 or BS 1363/A plug and correctly rated 10 Amp BS 1362 fuse. If in doubt, consult a qualified electrician.



**NOTE:** If a moulded plug is fitted and has to be removed take great care in disposing of the plug and severed cable, it must be destroyed to prevent engaging into a socket.

## Repair

This product does not contain any parts that can be repaired by the consumer. Contact an authorised service centre or a similarly qualified person to have it checked and repaired.

## Storage

1. Switch the product off, disconnect it from the power supply and let it cool down.
2. Empty the magazine (8).
3. Clean the product as described above.
4. Clean and lubricate the spring and the safety yoke (11) as needed.
5. Store the product and its accessories in a dark, dry, frost-free, well-ventilated place.
6. Always store the product in a place that is inaccessible to children. The ideal storage temperature is between 10°C and 30°C.
7. We recommend using the original package for storage or covering the product with a suitable cloth or enclosure to protect it against dust.

## Transportation

1. Switch the product off, disconnect it from the power supply and let it cool down.
2. Empty the magazine (8).
3. Always carry the product by its handle grip (3).
4. Protect the product from any heavy impact or strong vibrations which may occur during transportation in vehicles.
5. Secure the product to prevent it from slipping or falling over.

## Troubleshooting

Suspected malfunctions are often due to causes that the users can fix themselves. Therefore check the product using this section. In most cases the problem can be solved quickly.



**WARNING!** Only perform the steps described within these instructions! All further inspection, maintenance and repair work must be performed by an authorised service centre or a similarly qualified specialist if you cannot solve the problem yourself!

Problem	Possible cause	Solution
1. Product does not start	1.1. Not connected to power supply 1.2. Power cord or plug is defective  1.3. No firing after operating the trigger (2) and safety yoke (11) 1.4. The stopper (13) is obstructed by the clamping knob (12) 1.5. Other electrical defect to the product	1.1. Connect to power supply 1.2. Check by a specialist electrician 1.3. Refer to section "Operation → Firing" 1.4. Secure the clamping button (12) again 1.5. Check by a specialist electrician
2. Product does not reach full power	2.1. Extension cord not suitable for operation with this product 2.2. Power source (e. g. generator) has too low voltage 2.3. Air vents are blocked	2.1. Use a proper extension cord 2.2. Connect to another power source 2.3. Clean the air vents
3. Unsatisfactory result	3.1. The driven nails/staples are not flush with the work surface 3.2. Improper nails/staples are used	3.1. Choose suitable impact force 3.2. Choose suitable size of the nails/staples
4. The firing suddenly stops	4.1. Nail/staple is blocked  4.2. Magazine (8) is empty	4.1. Remove jam and use suitable sized nails/staples 4.2. Refill the magazine (8)
5. Excessive vibration or noise	5.1. Safety yoke (11) is loose 5.2. Screws are loose	5.1. Secure the clamping button (12) again 5.2. Tighten screws



## Recycling and disposal



Waste electrical products should not be disposed of with household waste. Please recycle where facilities exist.

Check with your Local Authority or local store for recycling advice.



For further information visit [www.recycle-more.co.uk](http://www.recycle-more.co.uk).

The product comes in a package that protects it against damage during shipping. Keep the package until you are sure that all parts have been delivered and the product is working properly. Recycle the package afterwards.

In more detail...

## Guarantee

We take special care to select high quality materials and use manufacturing techniques that allow us to create products incorporating design and durability. This product (TITAN 32mm Nailer & Stapler) has a manufacturer's guarantee of 2 years against manufacturing defects, from the date of purchase (if bought in store) or date of delivery (if bought online), at no additional cost for normal (non-professional or commercial) household use.

To make a claim under this guarantee, you must present your proof of purchase (such as a sales receipt, purchase invoice or other evidence admissible under applicable law), please keep your proof of purchase in a safe place. For this guarantee to apply, the product you purchased must be new, it will not apply to second hand or display products. Unless stated otherwise by applicable law, any replacement product issued under this guarantee will only be guaranteed until expiry of the original guarantee period.

This guarantee covers product failures and malfunctions provided the product was used for the purpose for which it is intended and subject to installation, cleaning, care and maintenance in accordance with the information contained in these terms and conditions, in the user manual and standard practice, provided that standard practice does not conflict with the user manual.

This guarantee does not cover defects and damage caused by normal wear and tear or damage that could be the result of improper use, faulty installation or assembly, neglect, accident, misuse, or modification of the product. Unless stated otherwise by applicable law, this guarantee will not cover, in any case, ancillary costs (shipping, movement, costs of uninstalling and reinstalling, labour etc), or direct and indirect damage.

This guarantee does not cover defects and damage caused by or resulting from:

- Normal wear and tear
- Overload, misuse or neglect
- Repairs attempted by anyone other than an authorised agent
- Cosmetic damage
- Damage caused by foreign objects, substances or accidents
- Accidental damage or modification
- Failure to follow manufacturer's guidelines
- Loss of use of the goods

If the product is defective, we will, within a reasonable time, repair or replace it. Rights under this guarantee are enforceable in the country in which you purchased this product. Guarantee related queries should be addressed to the store you purchased this product from.

The guarantee is in addition to and does not affect your statutory rights.

 <b>(EN) EU DECLARATION OF CONFORMITY</b> <b>(FR) DÉCLARATION UE DE CONFORMITÉ</b> <b>(PL) DEKLARACJA ZGODNOŚCI UE</b> <b>(RO) DECLARAȚIA DE CONFORMITATE UE</b> <b>(ES) DECLARACIÓN UE DE CONFORMIDAD</b> <b>(PT) DECLARAÇÃO DE CONFORMIDADE UE</b>		
Product / Produit / Produkt / Prodsus / Producto / Produto		
<ul style="list-style-type: none"> <li>• 32 mm Nailer &amp; Stapler/ Clouuse et agrafeuse 32 mm/ Zszywacz-gwoździarka 32 mm/ Pistol pentru cui și capace 32 mm/ Clavadora y grapadora de 32 mm/ Pistola de pregos e agrafador de 32 mm</li> <li>• TTB970NST MCB972NST</li> <li>• Serial number range 000001 to 999999</li> </ul>		
Name and address of the manufacturer or his authorised representative: Nom et adresse du fabricant ou de son mandataire: Nazwa i adres producenta lub jego upoważnionego przedstawiciela: Denumirea și adresa producătorului sau a reprezentantului său autorizat: Nombre y dirección del fabricante o de su representante autorizado: Nome e endereço do fabricante ou do respetivo mandatário:		
Kingfisher International Products B.V. Rapunburgerstraat 175E, 1011 VM Amsterdam, The Netherlands		
This declaration of conformity is issued under the sole responsibility of the manufacturer. La présente déclaration de conformité est établie sous la seule responsabilité du fabricant. Niniejsza deklaracja zgodności wydana zostaje na wyłączną odpowiedzialność producenta. Prezenta declarație de conformitate este emisă pe răspunderea exclusivă a producătorului. La presente declaración de conformidad se expide bajo la exclusiva responsabilidad del fabricante. A presente declaração de conformidade é emitida sob a exclusiva responsabilidade do fabricante.		
Object of the declaration / Objet de la déclaration / Przedmiot deklaracji / Obiectul declarației / Objeto de la declaración / Objeto da declaração		
Product / Produit / Produkt / Prodsus / Producto / Produto	Model / Modèle / Model / Modelo / Modelo / Modelo	EAN
32mm Nailer & Stapler/ Clouuse et agrafeuse 32 mm/ Zszywacz-gwoździarka 32 mm/ Pistol pentru cui și capace 32 mm/ Clavadora y grapadora de 32 mm/ Pistola de pregos e agrafador de 32 mm	TTB970NST MCB972NST	5063022074331 5059340701486 5059340701523
The object of the declaration described above is in conformity with the relevant Union harmonisation legislation: L'objet de la déclaration décrit ci-dessus est conforme à la législation d'harmonisation de l'Union applicable: Wymieniony powyżej przedmiot niniejszej deklaracji jest zgodny z odpowiednimi wymaganiami unijnego prawodawstwa harmonizacyjnego: Obiectul declarației descris mai sus este în conformitate cu legislația relevantă de armonizare a Uniunii: El objeto de la declaración descrita anteriormente es conforme con la legislación de armonización pertinente de la Unión: O objeto da declaração acima descrito está em conformidade com a legislação de harmonização da União aplicável:		
2006/42/EC as amended Machinery Directive 2014/30/EU as amended Directive Electromagnetic compatibility 2011/65/EU as amended Directive Restriction of the use of certain hazardous substances in electrical and electronic equipment Directive 2006/42/CE relative aux machines 2014/30 / UE telle que modifiée Directive Compatibilité électromagnétique Directive 2011/65/UE relative à la limitation de l'utilisation de certaines substances dangereuses dans les équipements électriques et électroniques		

2006/42/WE w zmiennej dyrektywie maszynowej  
 2014/30 / UE ze zmianami Dyrektywa Kompatybilność elektromagnetyczna  
 2011/65 / UE ze zmianami Dyrektywa Ograniczenie stosowania niektórych niebezpiecznych substancji w sprzęcie elektrycznym i elektronicznym  
 2006/42/CE, astfel a fost modificată Directiva privind echipamentele  
 2014/30/UE, astfel a fost modificată Directiva privind compatibilitatea electromagnetică  
 2011/65/UE, astfel a fost modificată Directiva privind limitarea utilizării anumitor substanțe periculoase în echipamentele electrice și electronice  
 Directiva sobre maquinaria modificada 2006/42/CE  
 2014/30/UE modificada Directiva Compatibilidad electromagnética  
 2011/65/UE modificada Directiva Restricción del uso de determinadas sustancias peligrosas en equipos eléctricos y electrónicos  
 2006/42/CE como directiva de máquinas alteradas  
 2014/30/UE como alteração da compatibilidade eletromagnética  
 2011/65/UE como restrição directiva alterada da utilização de certas substâncias perigosas em equipamentos elétricos e eletrônicos

References to the relevant harmonised standards used or references to the other technical specifications in relation to which conformity is declared:

Références des normes harmonisées pertinentes appliquées, y compris la date de celles-ci, ou des autres spécifications techniques, y compris la date de celles-ci, par rapport auxquelles la conformité est déclarée:

Odwolania do odnośnych norm zharmonizowanych, które zastosowano, wraz z datą normy, lub do innych specyfikacji technicznych, wraz z datą specyfikacji, w odniesieniu do których deklarowana jest zgodność:

Trimiteri la standardele armonizate relevante folosite, inclusiv data standardului, sau trimiteri la celelalte specificații tehnice, inclusiv data specificațiilor, în legătură cu care se declară conformitatea:

Referencias a las normas armonizadas pertinentes utilizadas, incluidas las fechas de las normas, o referencias a las otras especificaciones técnicas, incluidas las fechas de las especificaciones, respecto a las cuales se declara la conformidad:

Referências às normas harmonizadas aplicáveis utilizadas, incluindo a data da norma, ou às outras especificações técnicas, incluindo a data da especificação, em relação às quais é declarada a conformidade:

EN 60745-1:2009/A11:2010  
 EN 60745-2-16:2010  
 EN IEC 55014-1:2021  
 EN IEC 55014-2:2021  
 EN IEC 61000-3-2:2019/A1:2021  
 EN 61000-3-11:2019

Authorised signatory and technical file holder/signataire et responsable de la documentation technique autorisé/  
 podmiot uprawniony do wystawienia i adres przechowywania dokumentacji technicznej/bemnatar autorizat și  
 deținător al dosarului tehnic/firmante autorizado y titular del expediente técnico/ signatário autorizado e detentor  
 da ficha técnica

Kingfisher International Products B.V.,  
 Rapenburgstraat 175E,  
 1011 VM Amsterdam,  
 The Netherlands



David Awe  
 Group Quality Director

On : 15-05-2023



 <b>(UK) DECLARATION OF CONFORMITY</b>		
<b>Product</b>		
<ul style="list-style-type: none"> <li>• 32mm Nailer &amp; Stapler</li> <li>• TTB970NST</li> <li>• Serial number range 000001 to 999999</li> </ul>		
<b>Name and address of the manufacturer or his authorised representative:</b>		
Kingfisher International Products Limited 1 Paddington Square London W2 1GG United Kingdom		
This declaration of conformity is issued under the sole responsibility of the manufacturer.		
<b>Object of the declaration</b>		
<b>Product</b>	<b>Model</b>	<b>EAN</b>
32mm Nailer & Stapler	TTB970NST	5063022074331
The object of the declaration described above is in conformity with the relevant legislation:		
Supply of Machinery (Safety) Regulations 2008 as amended Electromagnetic Compatibility Regulations 2016 as amended The Restriction of the use of Certain Hazardous Substances in Electrical and Electronic Equipment Regulations 2012 as amended		
References to the relevant designated standards used or references to the other technical specifications in relation to which conformity is declared:		
EN 60745-1:2009/A11:2010 EN 60745-2-16:2010 EN IEC 55014-1:2021 EN IEC 55014-2:2021 EN IEC 61000-3-2:2019/A1:2021 EN 61000-3-11:2019		
<b>Authorised signatory and technical file holder:</b>		
Kingfisher International Products Limited 1 Paddington Square London W2 1GG United Kingdom		
		
David Awe Group Quality Director		
		On : 15-05-2023

In more detail...



# TITAN





Manufacturer, Fabricant, Producent, Producător, Fabricante:

**UK Manufacturer:**

Kingfisher International Products Limited  
1 Paddington Square, London, W2 1GG  
United Kingdom  
[www.kingfisher.com/products](http://www.kingfisher.com/products)

**EU Manufacturer:**

Kingfisher International Products B.V.  
Rapenburgerstraat 175E  
1011 VM Amsterdam  
The Netherlands  
[www.kingfisher.com/products](http://www.kingfisher.com/products)

- |   |  |  |
|---|--|--|
|  <b>EM</b>   | <a href="http://www.diy.com">www.diy.com</a>             | To view instruction manuals online, visit <a href="http://www.kingfisher.com/products">www.kingfisher.com/products</a>                                   |
|  <b>FR</b>  | <a href="http://www.castorama.fr">www.castorama.fr</a>   | Pour consulter les manuels d'instructions en ligne, rendez-vous sur le site <a href="http://www.kingfisher.com/products">www.kingfisher.com/products</a> |
|  <b>PL</b> | <a href="http://www.castorama.pl">www.castorama.pl</a>   | Aby zapoznać się z instrukcją obsługi online, odwiedź stronę <a href="http://www.kingfisher.com/products">www.kingfisher.com/products</a>                |
|  <b>RO</b> | <a href="http://www.bricodexpo.ro">www.bricodexpo.ro</a> | Pentru a consulta manualele de instrucțiuni online, vizitați <a href="http://www.kingfisher.com/products">www.kingfisher.com/products</a>                |
|  <b>TR</b> | <a href="http://www.koctas.com.tr">www.koctas.com.tr</a> | Kullanım kılavuzuna internet üzerinden ulaşmak için <a href="http://www.kingfisher.com/products">www.kingfisher.com/products</a> adresini ziyaret edin   |