

NEO1R

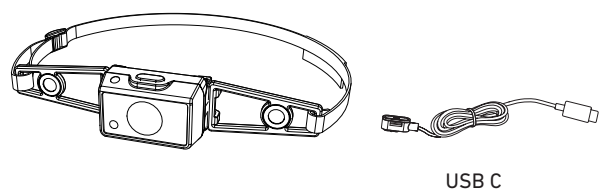

NEO1R

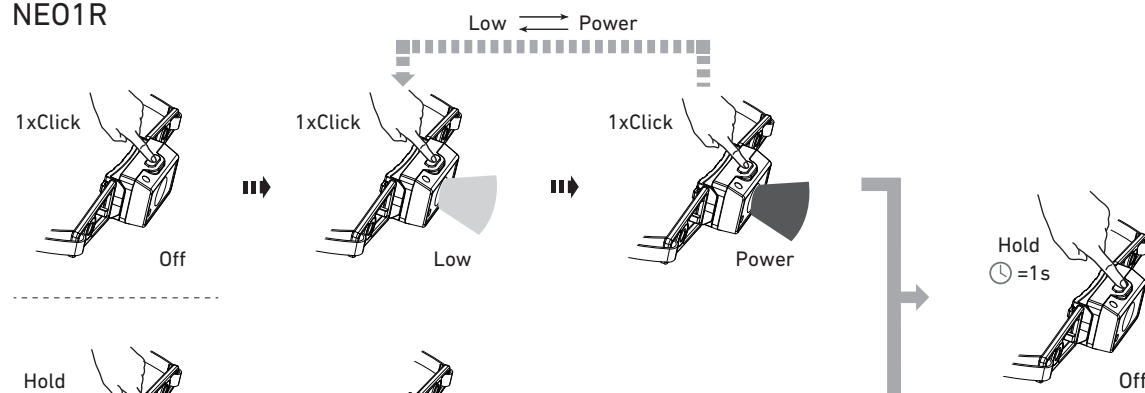

NEO3

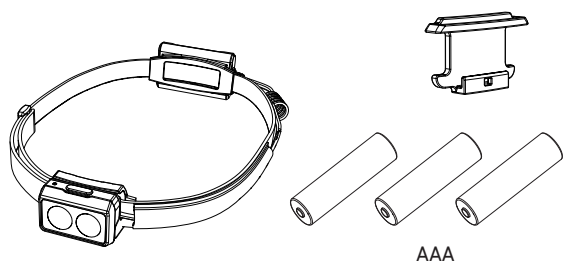

NEO5R

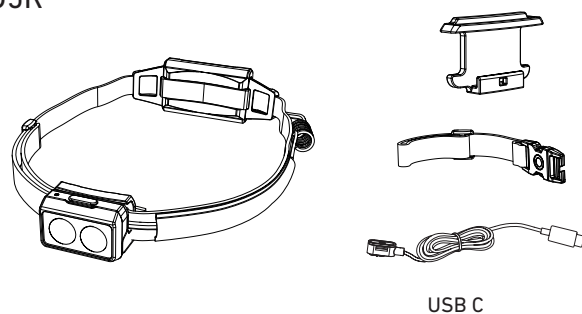

NEO3/NEO5R

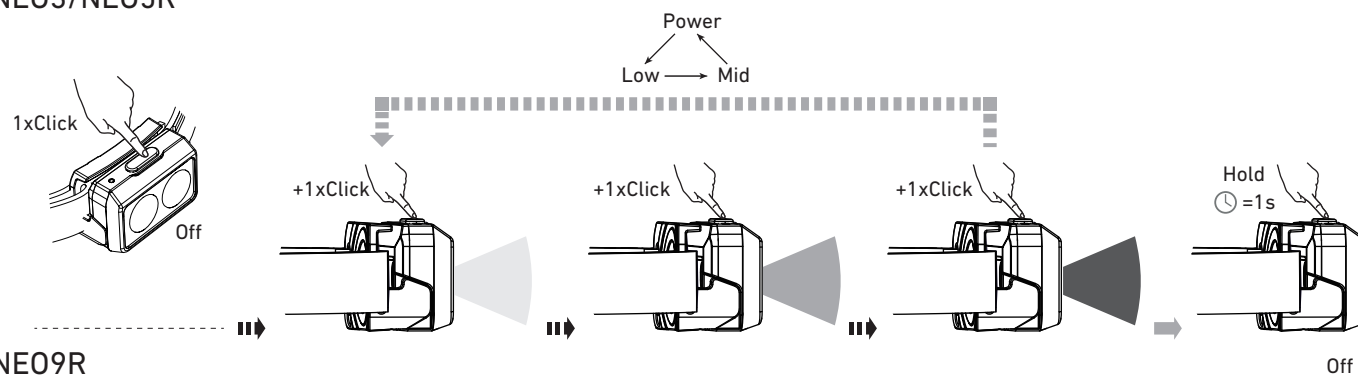

NEO9R

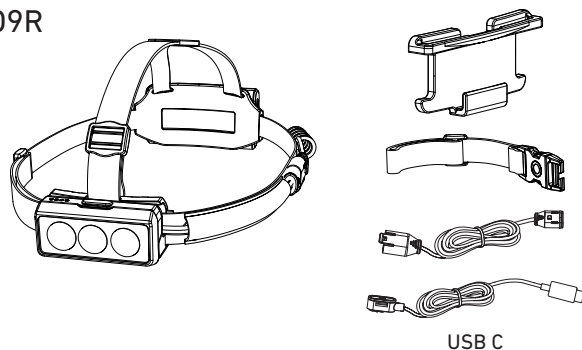

NEO9R

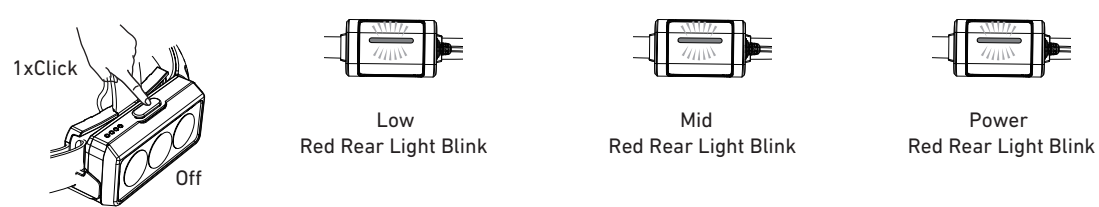

Boost (NEO1R/NEO3/NEO5R/NEO9R)

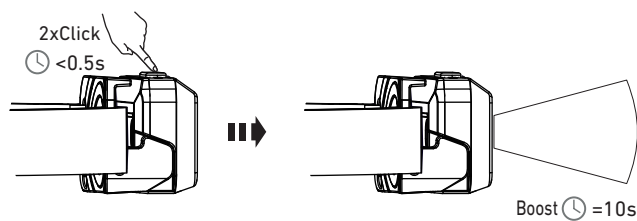

Boost Overheat Warning (NEO1R/NEO3/NEO5R/NEO9R)

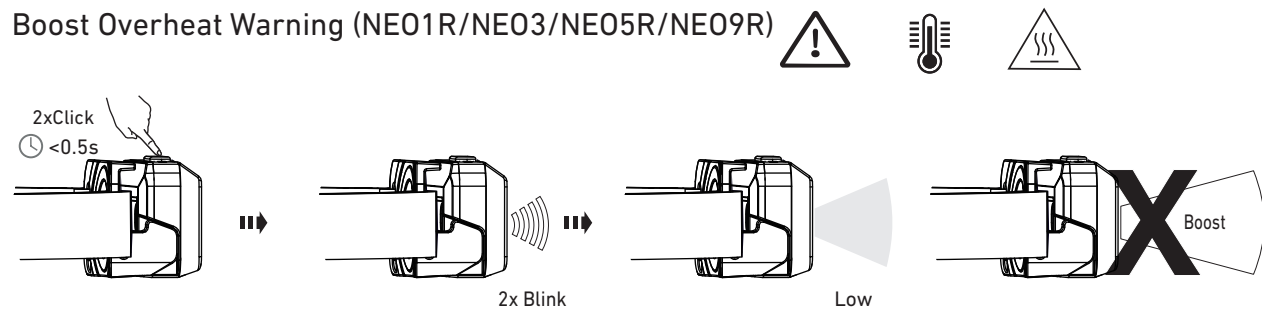

Transportation Lock (NEO1R/NEO3/NEO5R/NEO9R)

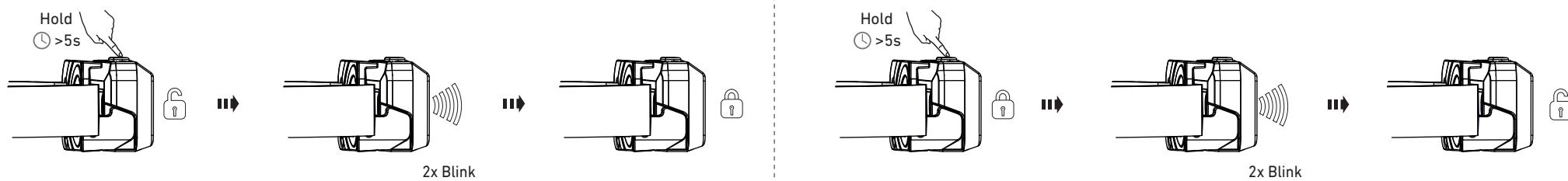

**Low Battery Warning
(NE01R/NE03/NE05R/NE09R)**

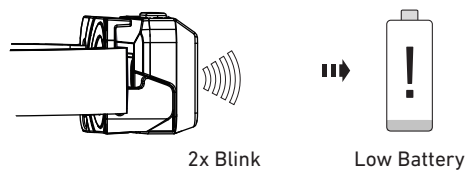

NE01R

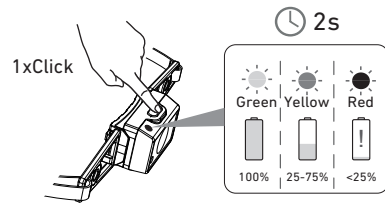

NE03/NE05R

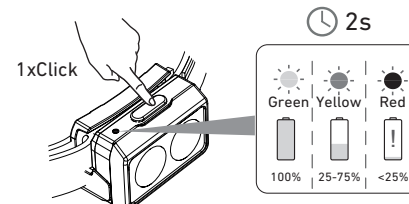

NE09R

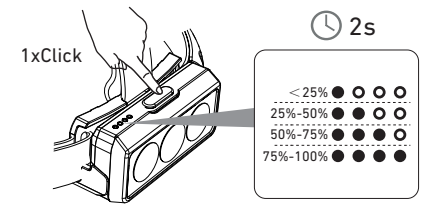

NE01R

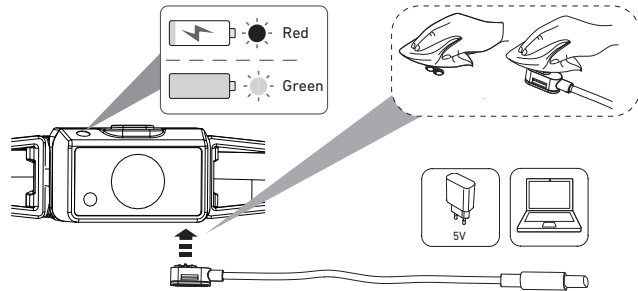

NE03

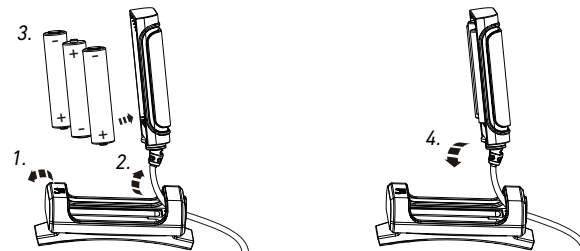

NE05R/NE09R

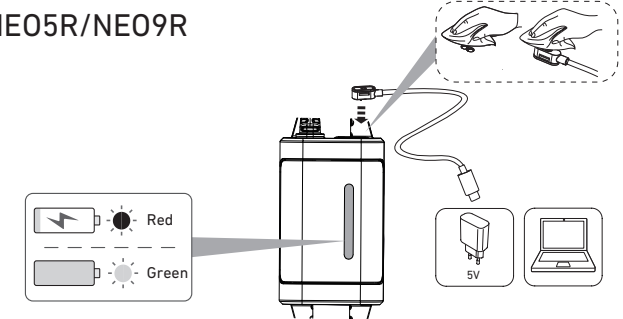

Battery Pack Replacement (NE09R)

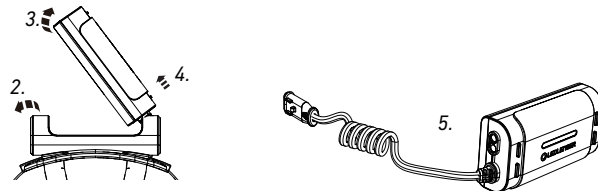
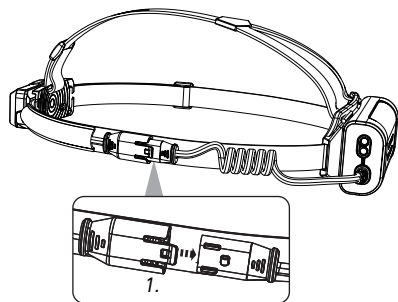

**Lamp Head Rotation
(NE01R/NE03/NE05R/NE09R)**

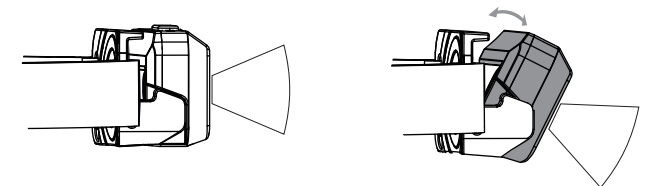

Chestbelt (NE05R/NE09R)

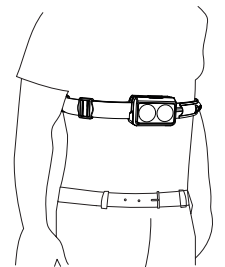
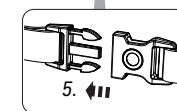
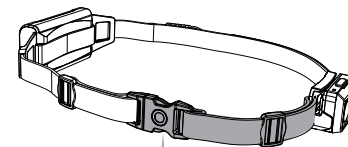
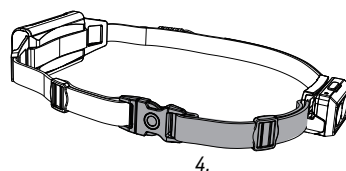
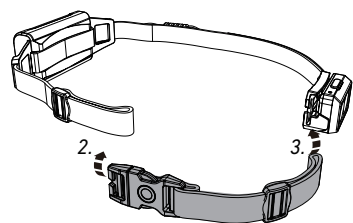
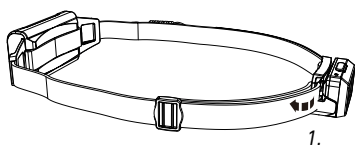

Silicone pad

NE03/NE05R

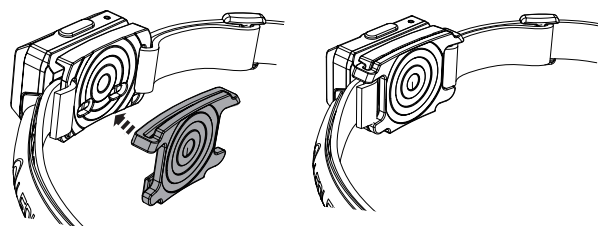

Overhead Band (NE09R)

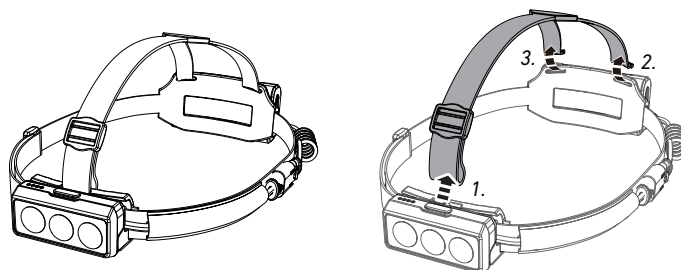

Extension Cable (NE09R)

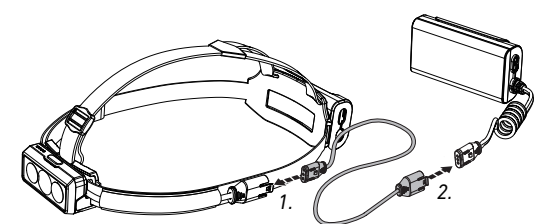

NE09R

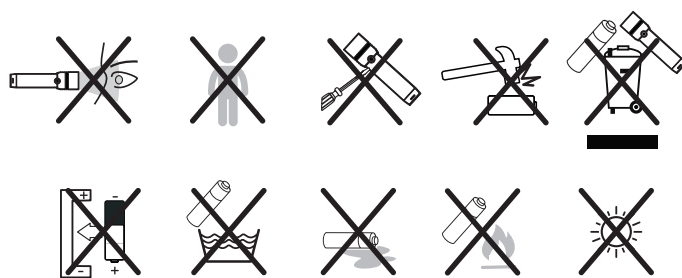
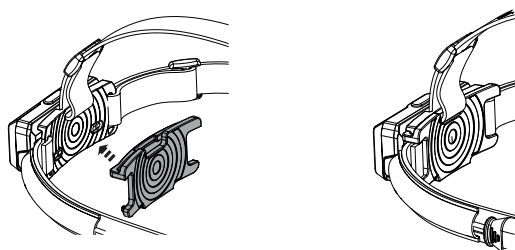

Ledlenser GmbH & Co. KG
Kronenstrasse 5-7 • 42699 Solingen • Germany
Phone +49 212/5948-0 Fax +49 212/5948-200
info@ledlenser.com

