

# LEDLENSER iH5/iH5R

iH5

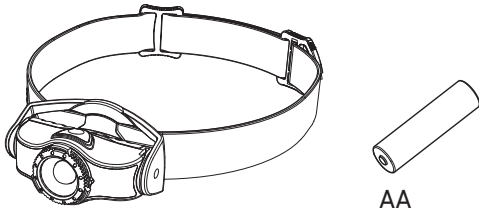

iH5R

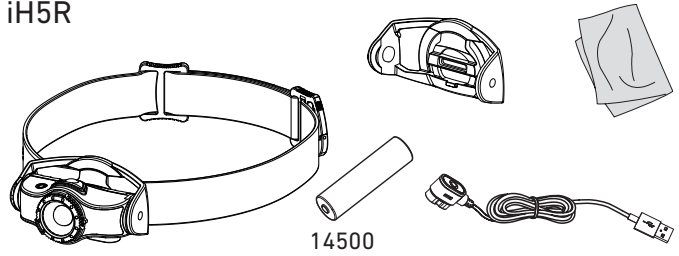

1

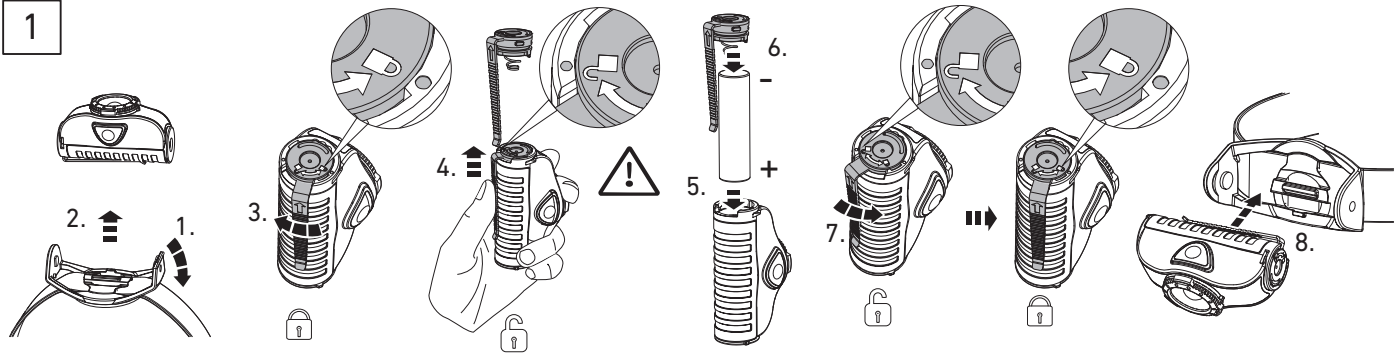

2

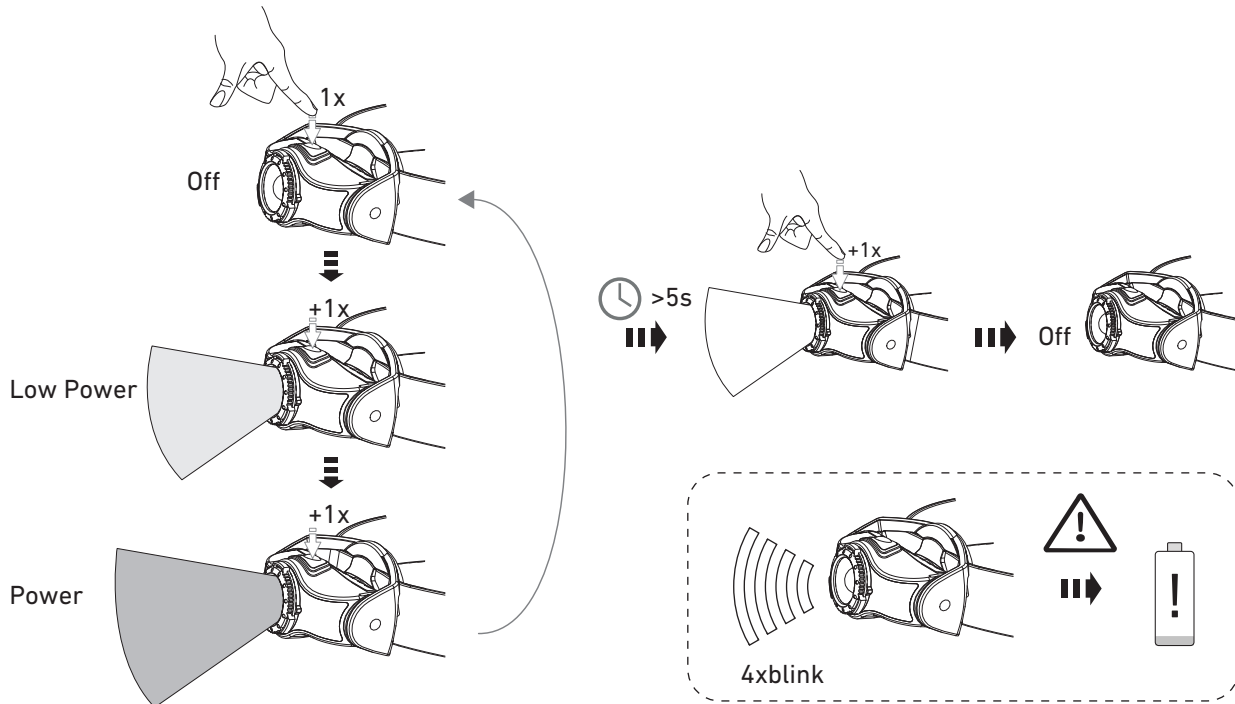

# LEDLENSER iH5/iH5R

3 iH5R

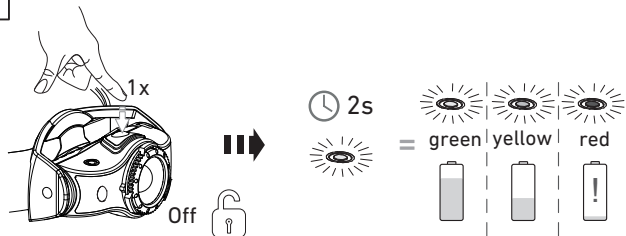

5

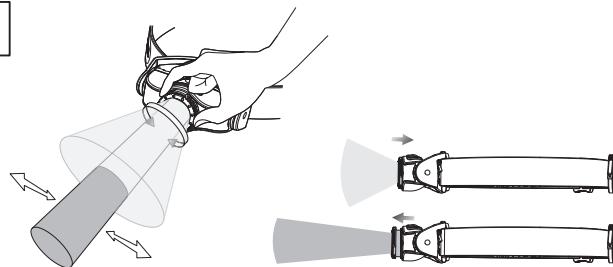

4 iH5R

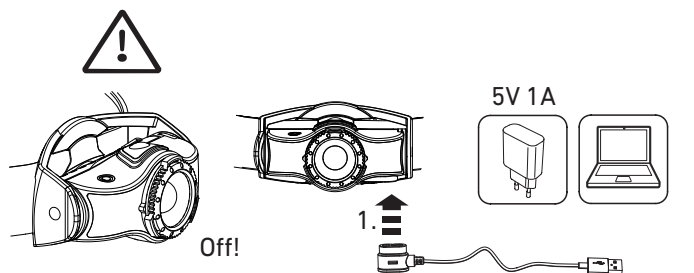

6 iH5R

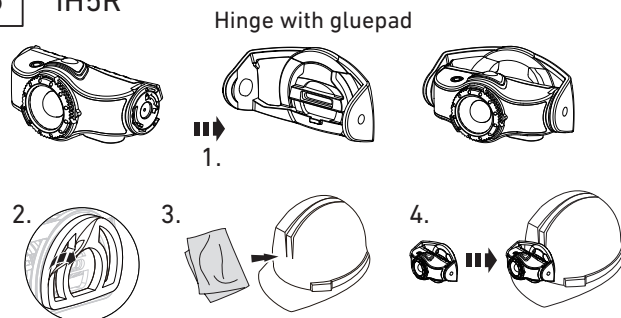

2.

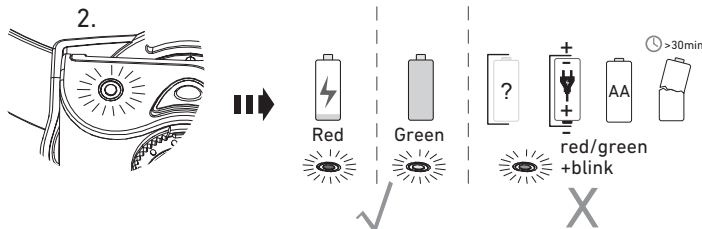

7

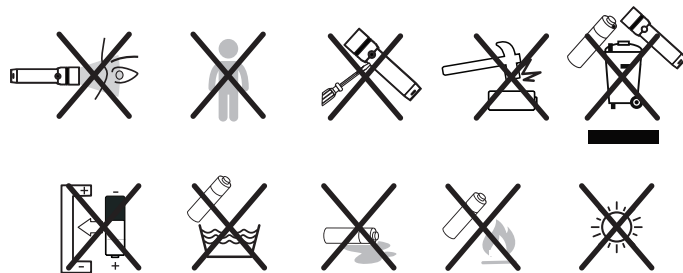
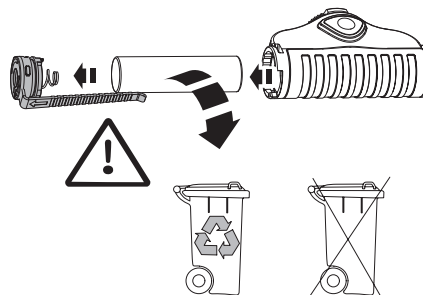

**Ledlenser GmbH & Co. KG**  
 Kronenstr. 5-7 • 42699 Solingen • Germany  
 Phone +49 212/5948-0 Fax +49 212/5948-200  
 info@ledlenser.com



iH5/iH5R V.03  
 06.05.2020  
 1J12A0379