

# TITAN

## Pole Hedge Trimmer 550W 50cm

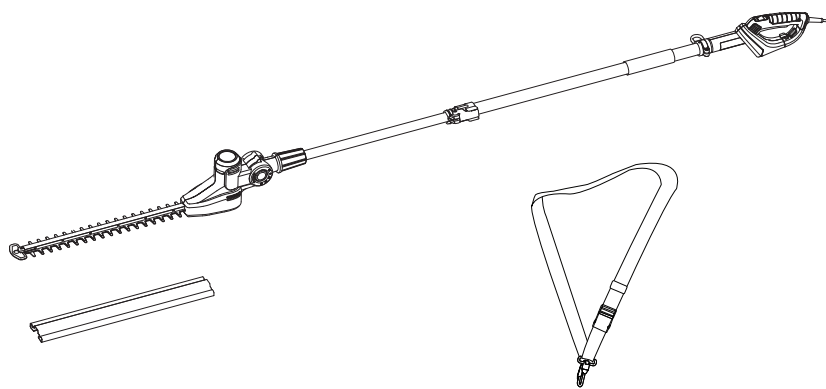

### TTB826HDC



# Let's get started...

These instructions are for your safety. Please read through them thoroughly before use and retain them for future reference.



## Getting **started...** 02

<b>Safety</b> information	03
<b>Your</b> product	12
<b>Before</b> you start	13



## **In more detail...** 17

<b>Product</b> functions	18
<b>Operation</b>	21
<b>Care</b> and <b>maintenance</b>	24
<b>Troubleshooting</b>	28
<b>Recycling</b> and <b>disposal</b>	28
<b>Guarantee</b>	29
<b>Technical</b> specifications	31
<b>Declaration</b> of <b>conformity</b>	33

## Safety warnings

### General power tool safety warnings



**WARNING!** Read all safety warnings, instructions, illustrations and specifications provided with this power tool. *Failure to follow all instructions listed below may result in electric shock, fire and/or serious injury.*

**Save all warnings and instructions for future reference.**

*The term “power tool” in the warnings refers to your mains-operated (corded) power tool or battery-operated (cordless) power tool.*

### Work area safety

1. **Keep work area clean and well lit.** *Cluttered or dark areas invite accidents.*
2. **Do not operate power tools in explosive atmospheres, such as in the presence of flammable liquids, gases or dust.** *Power tools create sparks which may ignite the dust or fumes.*
3. **Keep children and bystanders away while operating a power tool.** *Distractions can cause you to lose control.*

### Electrical safety

1. **Power tool plugs must match the outlet. Never modify the plug in any way. Do not use any adapter plugs with earthed (grounded) power tools.** *Unmodified plugs and matching outlets will reduce risk of electric shock.*
2. **Avoid body contact with earthed or grounded surfaces, such as pipes, radiators, ranges and refrigerators.** *There is an increased risk of electric shock if your body is earthed or grounded.*

## Safety warnings

---

- 3. Do not expose power tools to rain or wet conditions.** *Water entering a power tool will increase the risk of electric shock.*
- 4. Do not abuse the cord. Never use the cord for carrying, pulling or unplugging the power tool. Keep cord away from heat, oil, sharp edges or moving parts.** *Damaged or entangled cords increase the risk of electric shock.*
- 5. When operating a power tool outdoors, use an extension cord suitable for outdoor use.** *Use of a cord suitable for outdoor use reduces the risk of electric shock.*
- 6. If operating a power tool in a damp location is unavoidable, use a residual current device (RCD) protected supply.** *Use of an RCD reduces the risk of electric shock.*

### Personal safety

- 1. Stay alert, watch what you are doing and use common sense when operating a power tool. Do not use a power tool while you are tired or under the influence of drugs, alcohol or medication.** *A moment of inattention while operating power tools may result in serious personal injury.*
- 2. Use personal protective equipment. Always wear eye protection.** *Protective equipment such as dust mask, non-skid safety shoes, hard hat, or hearing protection used for appropriate conditions will reduce personal injuries.*
- 3. Prevent unintentional starting. Ensure the switch is in the off-position before connecting to power source, picking up or carrying the tool.** *Carrying power tools with your finger on the switch or energising*

- power tools that have the switch on invites accidents.*
- 4. Remove any adjusting key or wrench before turning the power tool on.** *A wrench or a key left attached to a rotating part of the power tool may result in personal injury.*
  - 5. Do not overreach. Keep proper footing and balance at all times.** *This enables better control of the power tool in unexpected situations.*
  - 6. Dress properly. Do not wear loose clothing or jewellery. Keep your hair and clothing away from moving parts.** *Loose clothes, jewellery or long hair can be caught in moving parts.*
  - 7. If devices are provided for the connection of dust extraction and collection facilities, ensure these are connected and properly used.** *Use of dust collection can reduce dust-related hazards.*
  - 8. Do not let familiarity gained from frequent use of tools allow you to become complacent and ignore tool safety principles.** *A careless action can cause severe injury within a fraction of a second.*

## Power tool use and care

- 1. Do not force the power tool. Use the correct power tool for your application.** *The correct power tool will do the job better and safer at the rate for which it was designed.*
- 2. Do not use the power tool if the switch does not turn it on and off.** *Any power tool that cannot be controlled with the switch is dangerous and must be repaired.*
- 3. Disconnect the plug from the power source and/or remove the battery pack, if detachable, from the power tool before making any adjustments, changing accessories, or storing power tools.** *Such preventive safety measures reduce the risk of starting the power tool accidentally.*
- 4. Store idle power tools out of the reach of children and do not allow persons unfamiliar with the power tool**

## Safety warnings

---

or these instructions to operate the power tool. *Power tools are dangerous in the hands of untrained users.*

5. **Maintain power tools and accessories.** Check for misalignment or binding of moving parts, breakage of parts and any other condition that may affect the power tool's operation. If damaged, have the power tool repaired before use. *Many accidents are caused by poorly maintained power tools.*
6. **Keep cutting tools sharp and clean.** *Properly maintained cutting tools with sharp cutting edges are less likely to bind and are easier to control.*
7. **Use the power tool, accessories and tool bits etc. in accordance with these instructions, taking into account the working conditions and the work to be performed.** *Use of the power tool for operations different from those intended could result in a hazardous situation.*
8. **Keep handles and grasping surfaces dry, clean and free from oil and grease.** *Slippery handles and grasping surfaces do not allow for safe handling and control of the tool in unexpected situations.*

### Service

1. **Have your power tools serviced by a qualified repair person using only identical replacement parts.** *This will ensure that safety of the power tool is maintained.*

### Hedge trimmer safety warnings:

1. **Keep all parts of the body away from the blade. Do not remove cut material or hold material to be cut when blades are moving.** *Blades continue to move after the switch is turned off. A moment of inattention while operating the hedge trimmer may result in serious personal injury.*

2. **Carry the hedge trimmer by the handle with the blade stopped and taking care not to operate any power switch.** *Proper carrying of the hedge trimmer will decrease the risk of inadvertent starting and resultant personal injury from the blades.*
3. **When transporting or storing the hedge trimmer, always fit the blade cover.** *Proper handling of the hedge trimmer will decrease the risk of personal injury from the blades.*
4. **When clearing jammed material or servicing the unit, make sure all power switches are off and the power cord is disconnected.** *Unexpected actuation of the hedge trimmer while clearing jammed material or servicing may result in serious personal injury.*
5. **Hold the hedge trimmer by insulated gripping surfaces only, because the blade may contact hidden wiring or its own cord.** *Blades contacting a "live" wire may make exposed metal parts of the hedge trimmer "live" and could give the operator an electric shock.*
6. **Keep all power cords and cables away from cutting area.** *Power cords or cables may be hidden in hedges or bushes and can be accidentally cut by the blade.*
7. **Do not use the hedge trimmer in bad weather conditions, especially when there is a risk of lightning.** *This decreases the risk of being struck by lightning.*

### **Additional safety warnings for pole hedge trimmer**

1. **To reduce the risk of electrocution, never use the pole hedge trimmer near any electrical power lines.** *Contact with or use near power lines may cause serious injury or electric shock resulting in death.*
2. **Always use two hands when operating the pole hedge trimmer.** *Hold the pole hedge trimmer with both hands to avoid loss of control.*
3. **Always use head protection when operating the pole**

## Safety warnings

---

**hedge trimmer overhead.** *Falling debris can result in serious personal injury.*

4. **Before operating the hedge trimmer, the user should make sure the locking device(s) of any moving elements (e.g. the extended shaft and pivoting element), if any, are in the locked position.**

### Vibration and noise reduction

**To reduce the impact of noise and vibration emission, limit the time of operation, use low-vibration and low-noise operating modes as well as wear personal protective equipment.**

Take the following points into account to minimise the vibration and noise exposure risks:

1. Only use the product as intended by its design and these instructions.
2. Ensure that the product is in good condition and well maintained.
3. Use correct attachments for the product and ensure they are in good condition.
4. Keep tight grip on the handles/grip surface.
5. Maintain this product in accordance with these instructions and keep it well lubricated (where appropriate).
6. Plan your work schedule to spread any high vibration tool use across a longer period of time.
7. Prolonged use of the product exposes the user to vibrations that can cause a range of conditions collectively known as hand-arm vibration syndrome (HAVS) e.g. fingers going white; as well as specific diseases such as carpal tunnel syndrome. To reduce this risk when using the product, always wear protective gloves and keep your hands warm.



## Emergency

**Familiarise yourself with the use of this product by means of this instruction manual. Memorise the safety directions and follow them to the letter. This will help to prevent risks and hazards.**

- 1. Always be alert when using this product, so that you can recognise and handle risks early.** *Fast intervention can prevent serious injury and damage to property.*
- 2. Switch the product off and disconnect from the power supply if there are malfunctions.** *Have the product checked by a qualified professional and repaired, if necessary, before you operate it again.*

## Residual risks

**Even if you are operating this product in accordance with all the safety requirements, potential risks of injury and damage remain. The following dangers can arise in connection with the structure and design of this product:**

















- 1. Health defects resulting from vibration emission if the product is being used over long periods of time or not adequately managed and properly maintained.**
- 2. Injuries and damage to property due to broken attachments or the sudden impact of hidden objects during use.**
- 3. Danger of injury and property damage caused by flying objects.**



**WARNING!** This product produces an electromagnetic field during operation! This field may under some circumstances interfere with active or passive medical implants! To reduce the risk of serious or fatal injury, we recommend persons with medical implants to consult their doctor and the medical implant manufacturer before operating this product!

## Symbols

On the product, the rating label and within these instructions you will find among others the following symbols and abbreviations. Familiarise yourself with them to reduce hazards like personal injuries and damage to property.

V~	Volt, (alternating voltage)	Hz	Hertz
/min or min <sup>-1</sup>	Per minute	W	Watt
cm	Centimeter	g	Gram
mm	Millimetre	kg	Kilogram
dB(A)	Decibel (A-rated)	m	Metre
	Lock / to tighten or secure.	m/s <sup>2</sup>	Metres per second squared
	Read the instruction manual.		Unlock / to loosen.
			Note / Remark.
xxWyy	Manufacturing date code; year of manufacturing (20xx) and week of manufacturing (Wyy)		Caution / Warning.
	Wear hearing protection.		Wear eye protection.
	Wear a dust mask.		Wear protective gloves.
	Wear protective, slip-resistant footwear.		
	Wear tight-fitted protective clothes.		
	Wear head protection, where there is a risk of falling objects.		
	Switch the product off and disconnect it from the power supply before assembly, cleaning, adjustments, maintenance, storage and transportation.		
	Do not expose the product to rain or wet conditions (moisture).		
	Keep hands away from moving cutting device!		



Keep sufficient distance away from electrical power lines.



Objects thrown by the product could hit the user or other bystanders. Always ensure that other people and pets remain at a safe distance from the product when it is in operation. In general, children must not come near the area where the product is.



Disconnect the product from the mains plug if the cord is damaged or entangled. **DON'T TOUCH THE CORD BEFORE DISCONNECTING THE SUPPLY.**



Guaranteed sound power level value in 105 dB.



The product is of Protection class II. That means it is equipped with enhanced or double insulation.



The product complies with the applicable European directives and an evaluation method of conformity for these directives was done.



UK Conformity Assessed.



WEEE symbol. Waste electrical products should not be disposed of with household waste. Please recycle where facilities exist. Check with your Local Authority or local store for recycling advice.

## Your product

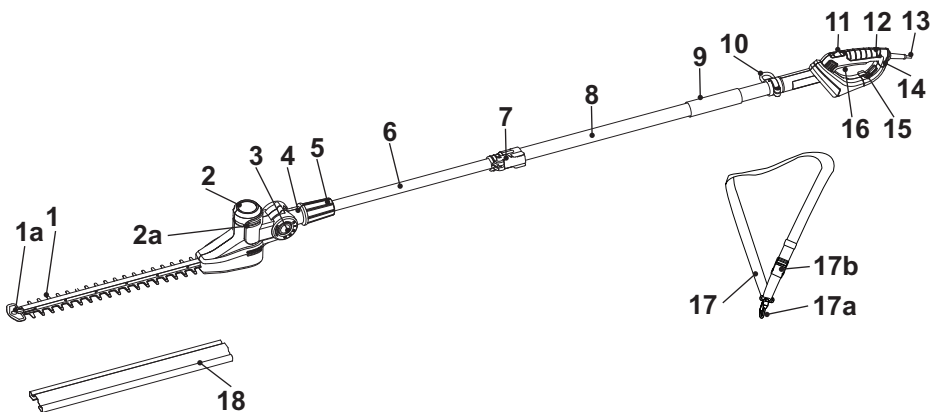

- |  |                          |
|--|--------------------------|
| 1. Cutting device (blade)              | 9. Soft grip             |
| a. Blade tip protector                 | 10. Loop                 |
| 2. Motor head                          | 11. Lock-off button      |
| a. Air vents                           | 12. Rear handle          |
| 3. Unlock button for angle adjustment  | 13. Power cord with plug |
| 4. Pole support                        | 14. Rear safeguard       |
| a. Bore (x2)*                          | 15. Cord retainer        |
| 5. Locking sleeve                      | 16. On/off switch        |
| 6. Pole extension                      | 17. Harness              |
| a. Lock pin (x2)*                      | a. Securing clip         |
| 7. Locking lever for length adjustment | b. Quick release         |
| 8. Front pole                          | 18. Blade cover          |



**NOTE:** Parts marked with \* are not shown in this overview. Please refer to the respective part in the instruction manual.

## Unpacking

1. Unpack all parts and lay them on a flat, stable surface.
2. Remove all packing materials and shipping devices if applicable.
3. Make sure the delivery contents are complete and free of any damage. If you find that parts are missing or show damage do not use the product but contact your dealer. Using an incomplete or damaged product represents a hazard to people and property.
4. Ensure that you have all the accessories and tools needed for assembly and operation. This also includes suitable personal protective equipment.



**WARNING!** The product and the packaging are not children's toys! Children must not play with plastic bags, sheets and small parts! There is a danger of choking and suffocation!

## You will need

(items not supplied)

Suitable personal protective equipment  
 Suitable extension cord for outdoor use  
 Lubricant for blade

(items supplied)

Harness (17)  
 Blade cover (18)



**NOTE:** The accessories required depend on the intended application. Ask your dealer for advice.

## Setup



**WARNING!** The product must be fully assembled before operation! Do not use a product that is only partly assembled or assembled with damaged parts!



Follow the assembly instructions step-by-step and use the pictures provided as a visual guide to easily assemble the product! Before using the product, familiarise yourself with the operating features read the entire instruction manual paying particular attention to the safety rules and operating procedures. Do not connect the product to power supply before removing the blade cover (11).

## Setup

### Pole assembly

1. Loosen the locking lever (7) (Fig. 1, step 1) and pull out the pole extension (6) (Fig. 1, step 2), then fasten the locking lever (7) (Fig. 1, step 3).
2. Move the locking sleeve (5) back onto the pole extension (Fig. 1, step 4).
3. Align the pole extension (6) with the pole support (4) and insert it. Make sure the pins (6a) snap in the bores (4a) for reliable connection (Fig. 1, step 5).
4. Fit the locking sleeve (5) on the thread of pole support (4) and tighten the locking sleeve (5) clockwise to secure the connections (Fig. 1, step 6).

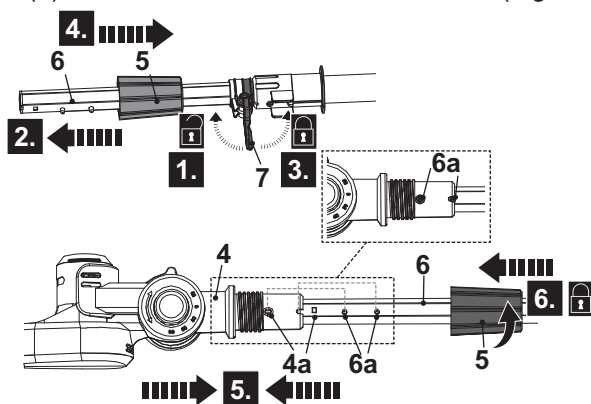

Fig. 1

### Blade cover

1. Remove the blade cover (18) from the cutting device (blade) (1) before operation (Fig. 2).
2. Keep the blade cover (18) safely.

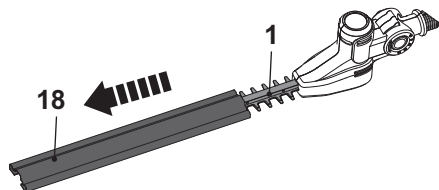

Fig. 2



**NOTE:** Always attach the blade cover (18) when the product is not in use, for storage and transportation.

To attach the blade cover (18), align and push the blade cover onto the cutting device (blade) (1).

## Connection to power supply

For safety reasons the product is equipped with a short power cord (13). Do not connect the product directly to the power supply using this power cord. A proper extension cord is required for operation. Observe the technical requirements for this product when purchasing an extension cord.



**NOTE:** For your safety, it is required that the plug attached to this product is always connected to an extension cord! The extension cord must be suitable for outdoor use with sockets protected against water splashing! Ensure the extension cord is of the proper size and type for your product ( $\geq 1.0 \text{ mm}^2$ )! Always use a residual current supply (RCD) protected supply.

1. Double the extension cord back, about 30 cm from the end and lead the loop through the hole of the rear safeguard (14) (Fig. 3, step 1).
2. Pull it over the cord retainer (15) and gently tug on the cord to ensure that it is firmly secured (Fig. 3, step 2).

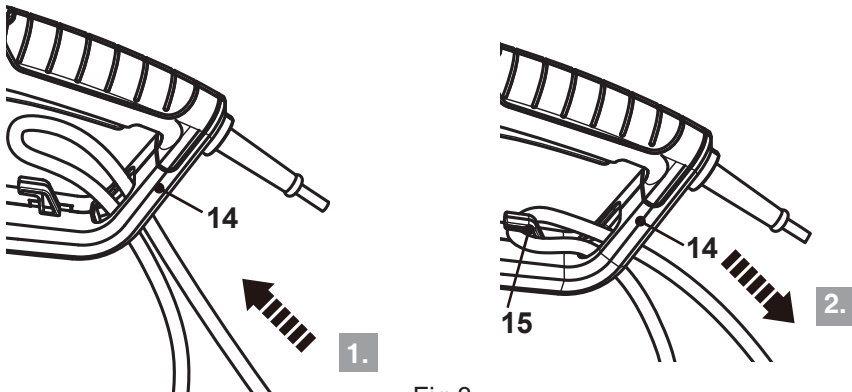

Fig.3

## Connection to power supply

3. Connect the power cord (13) to the socket of the extension cord (Fig. 4).

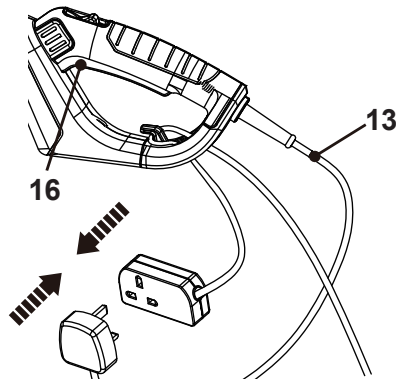

Fig.4

4. Make sure the on/off switch (16) is not squeezed.
5. Connect the plug of extension cord into a suitable socket.



**WARNING!** Check the voltage! The voltage must comply with the information on the rating label!

If using an extension cord it must be suitable for outdoor use with sockets protected against water splashing.

Ensure the extension cord is of the proper size and type for your product:

- 1.5 mm<sup>2</sup> for up to 60 m
- 2.5 mm<sup>2</sup> for up to 100 m

6. Your product is now ready to be used.





## In more detail...

<b>Product functions</b>	18
<b>Operation</b>	21
<b>Care and maintenance</b>	24
<b>Troubleshooting</b>	28
<b>Recycling and disposal</b>	28
<b>Guarantee</b>	29
<b>Technical specifications</b>	31
<b>Declaration of conformity</b>	33

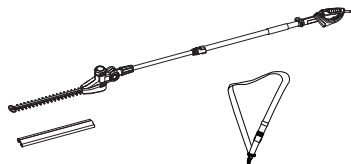

## Intended use

This electric hedge trimmer TTB826HDC is designated with a rated power input of 550 Watts.

The product is intended for cutting and trimming of hedges, bushes and shrubs in domestic gardens. The maximum cutting capacity must be observed. Do not cut branches exceeding the stated maximum capacity.

The use of this product in case of rain or humid environment is prohibited.

For safety reasons it is essential to read the entire instruction manual before first operation and to observe all the instructions therein.

This product is intended for private domestic use only, not for any commercial trade use. It must not be used for any purposes other than those described.

## Harness

The harness (17) helps the operator to carry the product.

1. Place the harness (17) so that it runs over the left shoulder, crossing the chest and back. The securing clip (17a) must be located at the right hip.

The quick release (17b) must be in front (Fig. 5).

2. Adjust the length of the harness (17) so that the securing clip (17a) is approximately 15 cm below your waist.
3. Attach the securing clip (17a) to the loop (10) (Fig. 6).
4. Lock the harness (17) onto the loop (10) by the securing clip (17a) (Fig. 7).

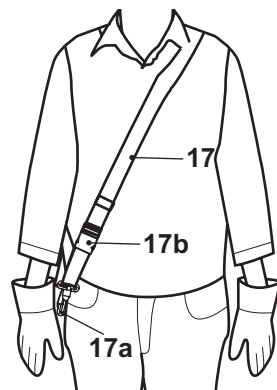

Fig. 5

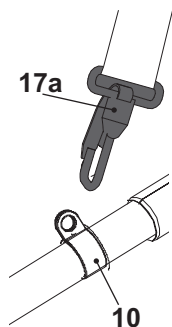

Fig. 6

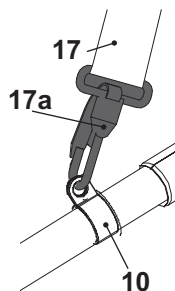

Fig. 7

## Harness



**WARNING!** Always attach the product to the harness (17). Do not carry it only with your hands!

- In case of emergency hold the soft grip (9) of the front pole (8) with the left hand, and use the right hand to press two clips of the quick release (17b). The product together with the securing clip (17a) will be released automatically from the body because of the weight of the product (Fig. 8).

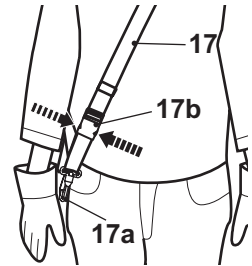

Fig. 8

## Length adjustment

- Loosen the locking lever (7) (Fig. 9, step 1).
- Adjust to the required length by pulling out or pushing in the pole extension (6) (Fig. 9, step 2).



**WARNING!** The length of the extension pole is limited! Stop pushing/pulling as soon as you feel a resistance! Extend the extension only to the length required to reach the hedges being trimmed! Do not attempt to use the product at a length which does not allow you to achieve proper footing and balance at all times!

- Secure the position of pole extension (6) by fastening the locking lever (7) back to its original position (Fig. 9, step 3).

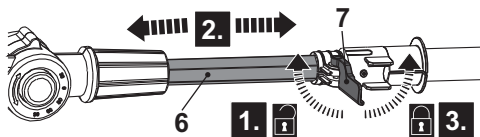

Fig. 9

## Angle adjustment

The angle of the blade head can be adjusted into five positions (Fig. 10):

1. Press the unlock button (3) to unlock the angleAdjustment and hold it in position.
2. Adjust the blade head to the desired position by swinging the pole support (4).
3. Release the unlock button (3) and keep moving the pole support (4) until it locks in place.
4. Ensure the unlock button (3) snaps in place before operation.

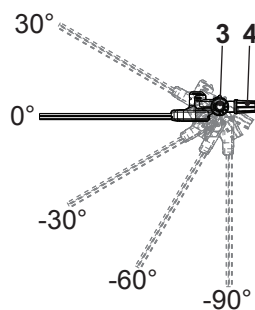

Fig. 10



**WARNING!** The blade head can be adjusted in five different positions. Always ensure the blade head is securely locked! Do not attempt to use the product with the head in an intermediate position!

## Switching on/off

1. Ensure the cutting device (blade) (1) does not touch any objects. Remove the blade cover (18) from the cutting device (blade) (1) before switching the product on.
2. Hold the product with one hand on the soft grip (9) of the front pole (8) and the other hand on the rear handle (12).
3. Pull back the lock-off button (11) and hold it in position (Fig. 11, step 1).
4. Squeeze the on/off switch (16) to switch the product on (Fig. 11, step 2). Release the lock-off button (11) afterwards.
5. Release the on/off switch (16) to switch the product off.

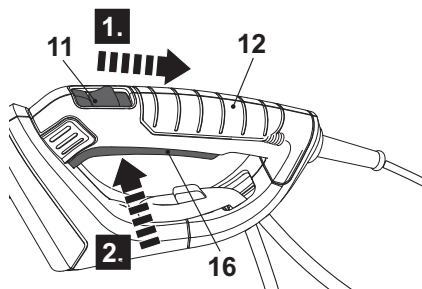

Fig. 11

## General operation

1. Check the product, its power cord and plug as well as accessories for damage before each use. Do not use the product if it is damaged or shows wear.
2. Double check that the accessories and attachments are properly fixed.
3. Always hold the product on its handles. Keep the handles dry to ensure safe support.
4. Ensure that the air vents are always unobstructed and clear. Clean them if necessary with a soft brush. Blocked air vents may lead to overheating and damage the product.
5. Switch the product off immediately if you are disturbed while working by other people entering the working area. Always let the product come to complete stop before putting it down.
6. Do not overwork yourself. Take regular breaks to ensure you can concentrate on the work and have full control over the product.



**WARNING!** Ensure the power cord or the extension cord will not touch the cutting device (blade) (1) during operating!

Danger of electric shock!

## Trimming times

green leaf hedges	June to October
evergreens	April and August
conifers and other fast growing shrubs	every 6 - 8 weeks

## Trimming



**NOTE:** Try to keep the cutting device angled at approximately 15° to the cutting surface.

1. Make sure that the blade cover (18) is removed.
2. Ensure that no people or animals are in the work area.
3. Adjust the product to a suitable pole length and blade head angle.
4. Carry the product with the harness (17).

## Trimming

5. Cut and remove branches exceeding the cutting capacity of this product using a proper pruner before operation.
6. Always hold the product firmly with both hands on soft grip (9) of the front pole (8) and the rear handle (12). Never operate this product using only one hand.
7. Do not rush and do not attempt to cut too much with one stroke of the cutting device.
8. First cutting both sides from the bottom upwards to the top. This will prevent any of the cuttings falling into the path of the area still to be cut (Fig. 12).
9. After cutting the sides proceed to the top. Try to keep the cutting device angled at approximately  $15^\circ$  to the cutting surface (Fig. 13).

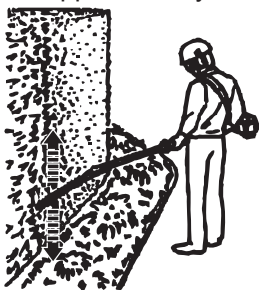

Fig. 12

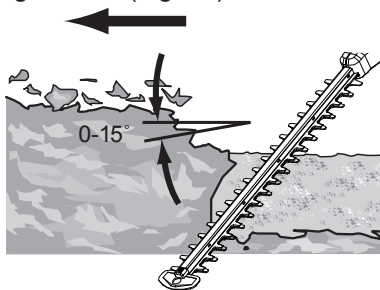

Fig. 13

10. When cutting wide hedges with the cutting area in sight move the cutting blade lightly through the cutting surface in a sweeping motion following the shape of the hedge or shrub. A slight tilt downwards of the cutting blade in the direction of motion is recommended for optimum cutting performance.

11. Cut in a number of stages to achieve a better result rather than trying to cut in one go if the area being cut is particularly long (Fig. 14); smaller cuttings will allow for easy composting.

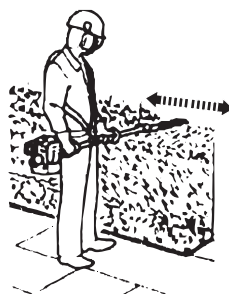

Fig. 14

12. Move the product with slow motion forward when cutting higher hedge and the cutting area out of sight (Fig. 15).



Fig. 15



**NOTE:** When shaping it is advisable to achieve a trapezoidal shape (Fig. 16). A trapezoidal cut corresponds to the natural growth of plants and results in optimal hedge growth, as it will expose more light to the lower end of the hedge.

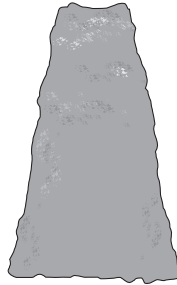

Fig. 16

13. Lubricate the internal surfaces of the blade if the cutting device (blade) (1) overheats during operation (Fig. 17).



**WARNING!** This operation must only be performed when the blades have stopped running and the product is switched off!

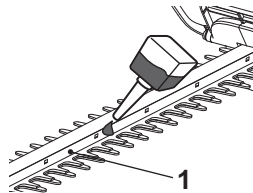

Fig. 17

## After use

1. Switch the product off, disconnect the product from the power supply and let it cool down.
2. Attach the blade cover (18) if necessary.
3. Check, clean and store the product as described below.

## The golden rules for care



**WARNING!** Always switch the product off, disconnect the plug from the power supply. Let the product cool down before performing inspection, maintenance and cleaning work!



1. Keep the product clean. Remove debris from it after each use and before storage.
2. Regular and proper cleaning will help ensure safe use and prolong the life of the product.
3. Inspect the product before each use for worn and damaged parts. Do not operate it if you find broken and worn parts.



**WARNING!** Only perform repairs and maintenance work according to these instructions! All further works must be performed by a qualified specialist!

## General Cleaning

1. Clean the product with a damp cloth and pH-neutral soap. Use a brush for areas that are hard to reach.
2. In particular clean the air vents (2a) after every use with a cloth and brush.
3. Remove stubborn dust with high pressure air (max. 3 bar).



**NOTE:** Do not use chemical, alkaline, abrasive or other aggressive detergents or disinfectants to clean this product as they might be harmful to its surfaces.

4. Check for worn or damaged parts. Replace worn parts as necessary or contact an authorised service centre for repair before using the product again. Check for worn or damaged parts. Replace worn parts as necessary or contact an authorised service centre for repair before using the product again.



## Cutting device (blade)



**WARNING!** Wear safety gloves when working on the cutting device and close to it! Use appropriate tools to remove debris, e. g. a brush or wooden stick! Never use your bare hands!



1. Keep the cutting device (blade) (1) clean and free of debris. Remove trimmings with a brush.
2. Apply a small amount of suitable lubricant on the cutting device (blade) to retain a good cutting performance (Fig. 17).

## Power cord

If the power cord is damaged, it must be replaced by the manufacturer, its service agent or similarly qualified persons in order to avoid a safety hazard.

## UK plug (only for UK market)

If you need to replace the fitted plug, then follow the instructions below.

**IMPORTANT:** The wires in the mains lead are coloured in accordance with the following code:

Blue – Neutral

Brown – Live

As the colours of the wire in the mains lead of this product may not correspond with the coloured marking identifying the terminals in your plug, proceed as follows. The wire, which is coloured blue, must be connected to the terminal, which is marked with N or coloured black. The wire, which is coloured brown, must be connected to the terminal, which is marked L or coloured red.

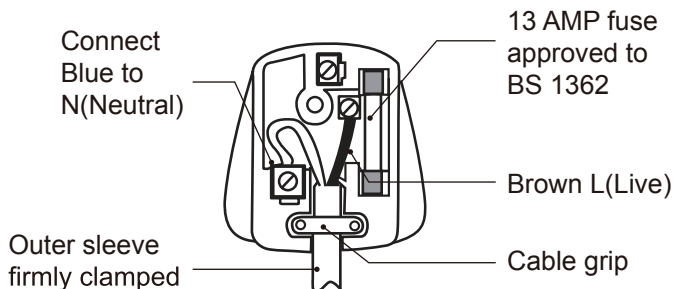

**WARNING!** Never connect live or neutral wires to the earth terminal of the plug, which is marked with E.

Only fit an approved 13 Amp BS 1363 or BS 1363/A plug and the correctly rated fuse.

If in doubt, consult a qualified electrician.



**NOTE:** If a moulded plug is fitted and has to be removed take great care in disposing of the plug and severed cable, it must be destroyed to prevent engaging into a socket.

## Repair

---

This product does not contain any parts that can be repaired by the consumer. Contact an authorised service centre or a similarly qualified person to have it checked and repaired.

## Storage

---

1. Switch the product off and disconnect it from the power supply.
2. Clean the product as described above.
3. Attach the blade cover (18) onto the cutting device (blade) (1).
4. Dismantle the pole assembly if necessary.
5. Store the product and its accessories in a dark, dry, frost-free, well-ventilated place.
6. Always store the product in a place that is inaccessible to children. The ideal storage temperature is between 10 °C and 30 °C.
7. We recommend using the original package for storage or covering the product with a suitable cloth or enclosure to protect it against dust.

## Transportation

---

1. Switch the product off and disconnect it from the power supply
2. Attach the blade cover (18) onto the cutting device (blade) (1).
3. Always carry the product by its soft grip (9) of the front pole (8) and rear handle (12).
4. Protect the product from any heavy impact or strong vibrations which may occur during transportation in vehicles.
5. Secure the product to prevent it from slipping or falling over.

## Troubleshooting

Suspected malfunctions are often due to causes that the users can fix themselves. Therefore check the product using this section. In most cases the problem can be solved quickly.



**WARNING!** Only perform the steps described within these instructions! All further inspection, maintenance and repair work must be performed by an authorised service centre or a similarly qualified specialist if you cannot solve the problem yourself!

Problem	Possible cause	Solution
1. Product does not start	1.1. Not connected to power supply 1.2. Power cord or plug is defective 1.3. Other electrical defect to the product	1.1. Connect to power supply 1.2. Check by a specialist electrician 1.3. Check by a specialist electrician
2. Product does not reach full power	2.1. Extension cord not suitable for operation with this product 2.2. Power source (e.g. generator) has too low voltage 2.3. Air vents are blocked	2.1. Use a proper extension cord 2.2. Connect to another power source 2.3. Clean the air vents
3. Unsatisfactory result	3.1. Blade is worn / damaged 3.2. Thickness of branches exceeds capacity	3.1. Replace with a new one 3.2. Only cut branches complying with the capacity
4. Excessive vibration or noise	4.1. Blade is dull / damaged 4.2. Bolts/nuts are loose	4.1. Replace with a new one 4.2. Tighten bolts/nuts

## Recycling and disposal



Waste electrical products should not be disposed of with household waste. Please recycle where facilities exist.

Check with your Local Authority or local store for recycling advice.

**For further information visit [www.recycle-more.co.uk](http://www.recycle-more.co.uk).**

The product comes in a package that protects it against damage during shipping. Keep the package until you are sure that all parts have been delivered and the product is working properly. Recycle the package afterwards.

## Guarantee

---

We take special care to select high quality materials and use manufacturing techniques that allow us to create products incorporating design and durability. This product has a manufacturer's guarantee of 2 years against manufacturing defects, from the date of purchase (if bought in store) or date of delivery (if bought online), at no additional cost for normal (non-professional or commercial) household use.

To make a claim under this guarantee, you must present your proof of purchase (such as a sales receipt, purchase invoice or other evidence admissible under applicable law), please keep your proof of purchase in a safe place. For this guarantee to apply, the product you purchased must be new, it will not apply to second hand or display products. Unless stated otherwise by applicable law, any replacement product issued under this guarantee will only be guaranteed until expiry of the original period guarantee period.

This guarantee covers product failures and malfunctions provided the product was used for the purpose for which it is intended and subject to installation, cleaning, care and maintenance in accordance with the information contained in these terms and conditions, in the user manual and standard practice, provided that standard practice does not conflict with the user manual.

This guarantee does not cover defects and damage caused by normal wear and tear or damage that could be the result of improper use, faulty installation or assembly, neglect, accident, misuse, or modification of the product. Unless stated otherwise by applicable law, this guarantee will not cover, in any case, ancillary costs (shipping, movement, costs of uninstalling and reinstalling, labour etc), or direct and indirect damage.

Rights under this guarantee are enforceable in the country in which you purchased this product. Guarantee related queries should be addressed to the store you purchased this product from.

The guarantee is in addition to and does not affect your statutory rights.

**Manufacturer:**

Kingfisher International Products Limited  
3 Sheldon Square, W26PX London United Kingdom  
[www.kingfisher.com/products](http://www.kingfisher.com/products)

## Guarantee

---

**Distributor:**

B&Q plc

Chandlers Ford, Hants, SO53 3LE, United Kingdom

[www.diy.com](http://www.diy.com)

Screwfix Direct Limited

Trade House, Mead Avenue, Yeovil, BA22 8RT, United Kingdom

[www.screwfix.com](http://www.screwfix.com)

## Technical specifications

### General

>Rated voltage, frequency	: 230-240 V~,50 Hz
>Rated power input	: 550 W
>Rated no load speed $n_0$	: 3800 min <sup>-1</sup>
>Blade length	: 50 cm
>Max. cutting length	: 47 cm
>Tooth spacing	: 28 mm
>Max. cutting diameter	: Max. 22 mm
>Protection class	: II / 
>Weight	: approx. 3.8 kg
>Length of power cord	: approx. 25 cm
>Dimensions	: approx. 174*100*2580 mm

### Sound values

>Sound pressure level at operator's position $L_{pA}$	: 91.29 dB(A)
>Uncertainty $K_{pA}$	: 3 dB(A)
>Measured sound power level $L_{WA}$	: 99.29 dB(A)
>Uncertainty $K_{WA}$	: 6.19 dB(A)

### Hand arm vibration values

>Front handle $a_{h,W}$	: 1.538 m/s <sup>2</sup>
>Rear handle $a_{h,W}$	: 2.107 m/s <sup>2</sup>
>Uncertainty $K$	: 1.5 m/s <sup>2</sup>

The sound values have been determined according to noise test code given in EN 62841-4-2, using the basic standards EN ISO 11201 and EN ISO 3744.

The sound intensity level for the operator may exceed 80 dB(A) and ear protection measures are necessary.

The declared vibration value has been measured in accordance with a standard test method (according to EN 62841-4-2) and may be used for comparing one product with another. The declared vibration value may also be used in a preliminary assessment of exposure.



**WARNING!** The vibration and noise emissions during actual use of the power tool can differ from the declared values depending on the ways in which the tool is used especially what kind of workpiece is processed; and need to identify safety measures to protect the operator that are based on an estimation of exposure in the actual conditions of use (taking account of all parts of the operating cycle such as the times when the tool is switched off and when it is running idle in addition to the trigger time).

## Rating label explanation

---

### **Pole Hedge Trimmer: TTB826HDC**

TTB=TITAN (brand)

826=Series number

HDC=Pole hedge trimmer



# Declaration of conformity



(EN) EU DECLARATION OF CONFORMITY  
(FR) DÉCLARATION UE DE CONFORMITÉ  
(PL) DEKLARACJA ZGODNOŚCI UE  
(RO) DECLARAȚIA DE CONFORMITATE UE  
(ES) DECLARACIÓN UE DE CONFORMIDAD  
(PT) DECLARAÇÃO DE CONFORMIDADE UE

Product/ Produit/ Produkt/Produsul/Producto/Produto		
<ul style="list-style-type: none"> <li>Pole Hedge Trimmer 550W 50cm/ Taille-haie électrique sur perche 550W 50cm/ Teleskopowe nożyce do żywopłotu 550W 50cm/ Unealtă de tuns gard viu cu braț telescopic 550W 50cm/ Cortasetos de altura 550W 50cm / Corta-sebes e podador 550W 50cm</li> <li>TTB826HDC</li> <li>Serial number: from 000001 to 999999</li> </ul>		
Name and address of the manufacturer or his authorised representative: Nom et adresse du fabricant ou de son mandataire: Nazwa i adres producenta lub jego upoważnionego przedstawiciela: Denumirea și adresa producătorului sau a reprezentantului său autorizat: Nombre y dirección del fabricante o de su representante autorizado: Nome e endereço do fabricante ou do respetivo mandatário:		
Kingfisher International Products B.V., Rapenburgerstraat 175E, 1011 VM Amsterdam, The Netherlands		
This declaration of conformity is issued under the sole responsibility of the manufacturer. La présente déclaration de conformité est établie sous la seule responsabilité du fabricant. Niniejsza deklaracja zgodności wydana zostaje na wyłączną odpowiedzialność producenta. Prezenta declarație de conformitate este emisă pe răspunderea exclusivă a producătorului. La presente declaración de conformidad se expide bajo la exclusiva responsabilidad del fabricante. A presente declaração de conformidade é emitida sob a exclusiva responsabilidade do fabricante.		
Object of the declaration/Objet de la déclaration/Przedmiot deklaracji/Obiectul declarației/Objeto de la declaración/Objeto da declaração		
Product/Produit/Produkt/Produsul/Producto/Produto	Model/Modèle/Model/Modelul/Modelo/Modelo	EAN
Pole Hedge Trimmer 550W 50cm/ Taille-haie électrique sur perche 550W 50cm/ Teleskopowe nożyce do żywopłotu 550W 50cm/ Unealtă de tuns gard viu cu braț telescopic 550W 50cm/ Cortasetos de altura 550W 50cm / Corta-sebes e podador 550W 50cm	TTB826HDC	5059340880785 (UK) 5059340240183 (EU)
The object of the declaration described above is in conformity with the relevant Union harmonisation legislation: L'objet de la déclaration décrit ci-dessus est conforme à la législation d'harmonisation de l'Union applicable: Wymieniony powyżej przedmiot niniejszej deklaracji jest zgodny z odpowiednimi wymaganiami unijnego prawodawstwa harmonizacyjnego: Obiectul declarației descris mai sus este în conformitate cu legislația relevantă de armonizare a Uniunii: El objeto de la declaración descrita anteriormente es conforme con la legislación de armonización pertinente de la Unión: O objeto da declaração acima descrito está em conformidade com a legislação de harmonização da União aplicável:		
2006/42/EC as amended Machinery Directive 2014/30/EU as amended Directive Electromagnetic compatibility 2000/14/EC as amended Outdoor Noise Directive 2011/65/EU as amended Directive Restriction of the use of certain hazardous substances in electrical and electronic equipment Directive 2006/42/CE relative aux machines 2014/30 / UE telle que modifiée Directive Compatibilități electromagnetice Directive 2000/14/CE relative aux émissions sonores extérieures Directive 2011/65/UE relative à la limitation de l'utilisation de certaines substances dangereuses dans les équipements électriques et électroniques 2006/42/WE w zmienionej dyrektywie maszynowej 2014/30 / UE ze zmianami Dyrektywa Kompatybilność elektromagnetyczna 2000/14/WE w zmienionej dyrektywie w sprawie hałasu na zewnątrz 2011/65 / UE ze zmianami Dyrektywa Ograniczenie stosowania niektórych niebezpiecznych substancji w sprzęcie elektrycznym i elektronicznym 2006/42/CE, astfel a fost modificată Directiva privind echipamentele 2014/30/UE, astfel a fost modificată Directiva privind compatibilitatea electromagnetică 2000/14/CE, astfel a fost modificată Directiva privind zgomotul în aer liber 2011/65/UE, astfel a fost modificată Directiva privind limitarea utilizării anumitor substanțe periculoase în echipamentele electrice și electronice Directiva sobre maquinaria modificada 2006/42/CE 2014/30/UE modificada Directiva Compatibilități electromagnetice 2000/14/CE modificada Directiva sobre ruido al aire libre 2011/65/UE modificada Directiva Restricción del uso de determinadas sustancias peligrosas en equipos eléctricos y electrónicos 2006/42/CE como diretiva de máquinas alteradas		

In more detail...

# Declaration of conformity

2014/30/UE como alteração da compatibilidade eletromagnético  
 2000/14/CE como diretiva de ruído exterior alterada  
 2011/65/UE como restrição diretiva alterada da utilização de certas substâncias perigosas em equipamentos elétricos e eletrônicos

#### Measured Sound Power Level

Le niveau de puissance acoustique mesuré

Zmierzony poziom mocy akustycznej

Nivel de putere acustică măsurat

Nivel de potencia sonora medido

Nivel de potência sonora medido

: 99.29 dB(A)

#### Guaranteed Sound Power Level

Le niveau de puissance acoustique garant

Gwarantowany poziom mocy akustycznej

Nivel de putere acustică garantat

Nivel de potencia sonora garantizado

Nivel de potência sonora garantido

: 105 dB(A)

References to the relevant harmonised standards used or references to the other technical specifications in relation to which conformity is declared:

Références des normes harmonisées pertinentes appliquées, y compris la date de celles-ci, ou des autres spécifications techniques, y compris la date de celles-ci, par rapport auxquelles la conformité est déclarée:

Odwolania do odnośnych norm zharmonizowanych, które zastosowano, wraz z datą normy, lub do innych specyfikacji technicznych, wraz z datą specyfikacji, w odniesieniu do których deklarowana jest zgodność:

Trimeri la standardele armonizate relevante folosite, inclusiv data standardului, sau trimeri la celelalte specificații tehnice, inclusiv data specificațiilor, în legătură cu care se declară conformitatea:

Referencias a las normas armonizadas pertinentes utilizadas, incluidas las fechas de las normas, o referencias a las otras especificaciones técnicas, incluidas las fechas de las especificaciones, respecto a las cuales se declara la conformidad:

Referências às normas harmonizadas aplicáveis utilizadas, incluindo a data da norma, ou às outras especificações técnicas, incluindo a data da especificação, em relação às quais é declarada a conformidade:

EN 62841-1: 2015

EN 62841-4-2: 2019

EN IEC 55014-1:2021

EN IEC 55014-2:2021

EN IEC 61000-3-2:2019 +A1

EN 61000-3-3:2013+A2

EN ISO 3744:1995

Authorised signatory and technical file holder/signataire et responsable de la documentation technique autorisé/ podmiot uprawniony do wystawienia i adres przechowujący dokumentację techniczną/semmnatar autorizat și deținător al dosarului tehnic/firmante autorizado y titular del expediente técnico/ signatário autorizado e detentor da ficha técnica

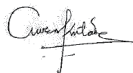

Kingfisher International Products B.V.,  
 Rapenburgerstraat 175E,  
 1011 VM Amsterdam,  
 The Netherlands



David Awe  
 Group Quality Director

: [26/06/2023]

# Declaration of conformity

 <b>(UK) DECLARATION OF CONFORMITY</b>		
Product		
<ul style="list-style-type: none"> <li>• Pole Hedge Trimmer 550W 50cm</li> <li>• TTB826HDC</li> <li>• Serial number: from 000001 to 999999</li> </ul>		
Name and address of the manufacturer or his authorised representative:		
Kingfisher International Products Limited 3 Sheldon Square London W2 6PX United Kingdom		
This declaration of conformity is issued under the sole responsibility of the manufacturer.		
Object of the declaration		
Product	Model	EAN
Pole Hedge trimmer 550W 50cm	TTB826HDC	5059340880785
The subject of the declaration described above is in conformity with the relevant legislation:		
Supply of Machinery (Safety) Regulations 2008 as amended Noise Emission in the Environment by Equipment for Use Outdoors Regulations 2001 as amended Electromagnetic Compatibility Regulations 2016 as amended The Restriction of the use of Certain Hazardous Substances in Electrical and Electronic Equipment Regulations 2012 as amended		
Measured Sound Power Level: 99.29 dB(A) Guaranteed Sound Power Level: 105 dB(A)		
References to the relevant designated standards used or references to the other technical specifications in relation to which conformity is declared:		
BS EN 62841-1: 2015 BS EN 62841-4-2: 2019 BS EN IEC 55014-1:2021 BS EN IEC 55014-2:2021 BS EN IEC 61000-3-2:2019 +A1 BS EN 61000-3-3:2013+A2 EN ISO 3744:1995		
Authorised signatory and technical file holder: Kingfisher International Products Limited 3 Sheldon Square London W2 6PX United Kingdom		
 David Awe Group Quality Director		
		On <b>[26/06/2023]</b>





In more detail...

## Customer Care and Technical Helpline

### A better way to repair your tools

Kingfisher takes special care in creating high-quality garden power tools that are designed to last. But if a fault develops with your garden power tool and you need to claim under the guarantee, the Customer Care and Technical Helpline can support with technical assistance or if required, arrange a free courier collection from your home, assess your garden power tool for fault, repair it, and return it.

Deciding to repair your product rather than buying a replacement and adding to the mountain of waste is a more sustainable choice and you will be doing your bit for the environment.

How does it work?				
				
<b>Step 1</b> Find your proof of purchase and get in touch with the Customer Care and Technical Helpline.	<b>Step 2</b> Chat to them about the problem with your tool.	<b>Step 3</b> They will provide technical and user advice or alternatively arrange a courier collection from your home*.	<b>Step 4</b> The team will assess and test and if necessary, repair your product back to full working order.	<b>Step 5</b> Your repaired tool will be returned to you via courier within 5 - 7 working days*.



\*please note that before collection, all fuel must be removed from petrol powered machines.

### Get in touch

If you need help or more information, please contact the Customer Care and Technical Helpline:

UK: 0800 0789647

Eire: 1800 932226

Opening hours are Monday – Friday, 8am-5pm

## Availability of Spare Parts

---

Contact the customer service helpline for assistance or visit  
[www.kingfisherspares.com](http://www.kingfisherspares.com)

For assistance contact the customer services helpline:  
UK 0800 0789647 [uk@Kingfisherservice.com](mailto:uk@Kingfisherservice.com)  
EIRE 1800 932226 [eire@kingfisherservice.com](mailto:eire@kingfisherservice.com)

Further information about this product can also be found at:  
[www.kingfisher.com/products](http://www.kingfisher.com/products)





# TITAN

Manufacturer, Fabricant, Producător, Producător, Fabricante:

## UK Manufacturer:

Kingfisher International Products Limited  
3 Sheldon Square, London, W2 6PX  
United Kingdom  
[www.kingfisher.com/products](http://www.kingfisher.com/products)

## EU Manufacturer:

Kingfisher International Products B.V.  
Rapenburgerstraat 175E  
1011 VM Amsterdam  
The Netherlands  
[www.kingfisher.com/products](http://www.kingfisher.com/products)

- |    |  |   |
|----|--|---|
| EN | <a href="http://www.diy.com">www.diy.com</a><br><a href="http://www.screwfix.com">www.screwfix.com</a><br><a href="http://www.screwfix.ie">www.screwfix.ie</a> | To view instruction manuals online, visit<br><a href="http://www.kingfisher.com/products">www.kingfisher.com/products</a>                                   |
| FR | <a href="http://www.castorama.fr">www.castorama.fr</a><br><a href="http://www.bricodepot.fr">www.bricodepot.fr</a>   | Pour consulter les manuels d'instructions en ligne,<br>rendez-vous sur le site <a href="http://www.kingfisher.com/products">www.kingfisher.com/products</a> |
| PL | <a href="http://www.castorama.pl">www.castorama.pl</a>   | Aby zapoznać się z instrukcją obsługi online, odwiedź<br>stronę <a href="http://www.kingfisher.com/products">www.kingfisher.com/products</a>                |
| ES | <a href="http://www.bricodepot.es">www.bricodepot.es</a>   | Para consultar los manuales de instrucciones en línea,<br>visite <a href="http://www.kingfisher.com/products">www.kingfisher.com/products</a>               |
| PT | <a href="http://www.bricodepot.pt">www.bricodepot.pt</a>   | Para consultar manuais de instruções online, visite<br><a href="http://www.kingfisher.com/products">www.kingfisher.com/products</a>                         |
| RO | <a href="http://www.bricodepot.ro">www.bricodepot.ro</a>   | Pentru a consulta manualele de instrucțiuni online, vizitați<br><a href="http://www.kingfisher.com/products">www.kingfisher.com/products</a>                |
| TR | <a href="http://www.koctas.com.tr">www.koctas.com.tr</a>   | Kullanım kılavuzuna internet üzerinden ulaşmak için<br><a href="http://www.kingfisher.com/products">www.kingfisher.com/products</a> adresini ziyaret edin   |