

INSTRUCTION MANUAL

TCP Smart 20lt Dehumidifier

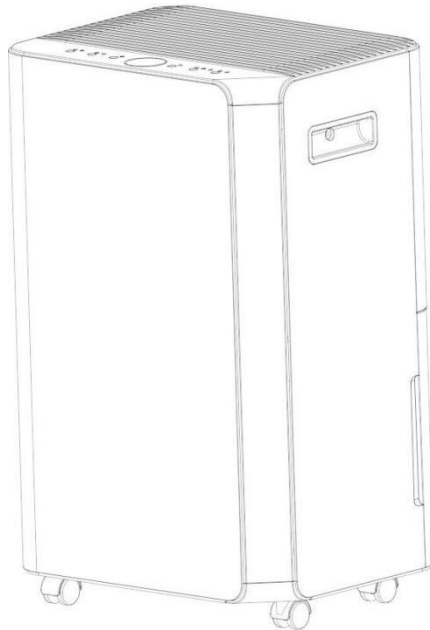

SMAWDEHUM20LBD068CF

Please keep this manual carefully for further reference!

Thank you for selecting our dehumidifier.

This device is designed to reduce the humidity levels in your indoor environment, creating a more comfortable living space and preventing the growth of mould and mildew. To ensure you get the most out of your dehumidifier, please read this instruction manual carefully before use.

CONTENT

1. BEFORE YOU BEGIN
2. PRODUCT OVERVIEW / DESCRIPTION
3. FOR YOUR SAFETY
 - 3.1 OPERATION PRECAUTIONS
 - 3.2 SAFETY PRECAUTIONS ON SERVICING
4. INSTALLATION
 - 4.1 LOCATION
5. OPERATION
 - 5.1 OPERATING THE DEVICE SAFELY
 - 5.2 EMPTYING THE TANK
 - 5.3 CONTINUOUS DRAINING
6. MAINTENANCE
 - 6.1 CLEANING THE AIR FILTER
7. TROUBLESHOOTING
 - 7.1 FUNCTIONAL TEMPERATURE
 - 7.2 TROUBLESHOOTING
8. DECOMMISSIONING
 - 8.1 STORAGE
 - 8.2 DISPOSAL
9. OPERATION CONTROL PANEL
 - 9.1 OPERATION
 - 9.2 FUNCTION KEYS AND INDICATORS
10. CONNECTING TO WIFI
11. USING THE TCP SMART APP

1.0 BEFORE YOU BEGIN







Please read this manual carefully and fully understand before operating your dehumidifier.

PRODUCT DESCRIPTION

The dehumidifier is used to remove excessive moisture from the air. The resulting reduction in relative humidity protects buildings and their contents from the adverse effects of excess humidity.

This dehumidifier uses the environmentally friendly R290 (propane) as the refrigerant. R290 (propane) has no damaging influence on the ozone layer (ODP), a negligible greenhouse effect (GWP) and is available worldwide. Because of its efficient energy properties, R290 (propane) is highly suitable as a coolant for this application. Special precautions must be taken into consideration due to the coolant's high flammability.

IMPORTANT SYMBOLS FROM THE UNIT AND USER MANUAL

 warning	<p>This unit uses a flammable refrigerant. If refrigerant leaks and comes in to contact with fire or heating part, it will create harmful gas and there is risk of fire.</p>
	<p>Read the USER MANUAL carefully before operation.</p>
	<p>Further information is available in the USER MANUAL, SERVICE MANUAL, and the like.</p>
	<p>Service personnel are required to carefully read the USER MANUAL and SERVICE MANUAL before operation.</p>

2.0 PRODUCT OVERVIEW

FRONT VIEW

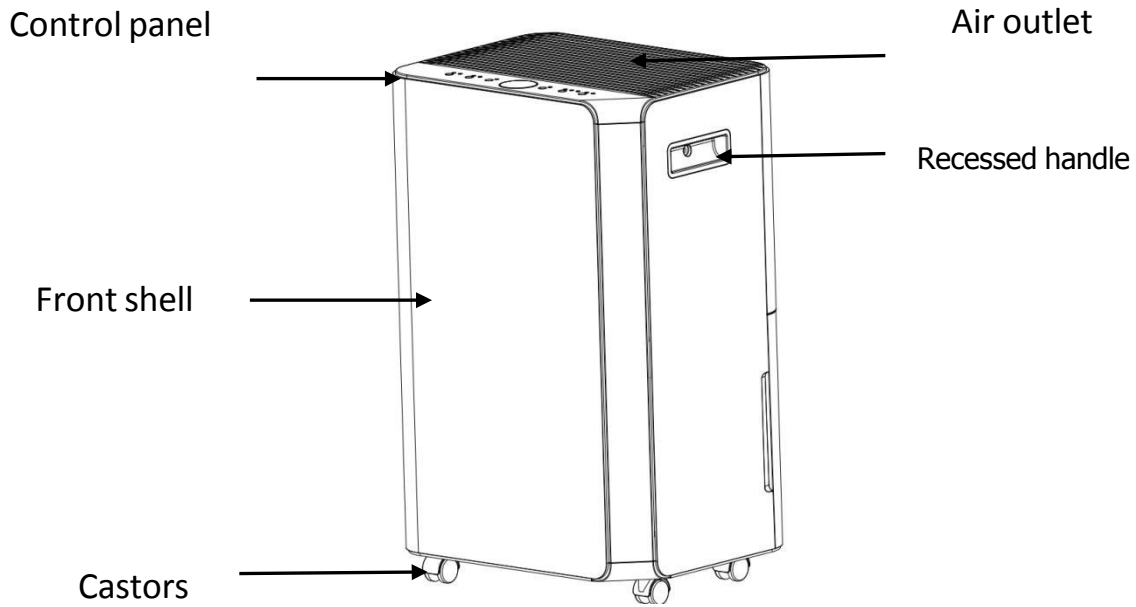

BACK VIEW

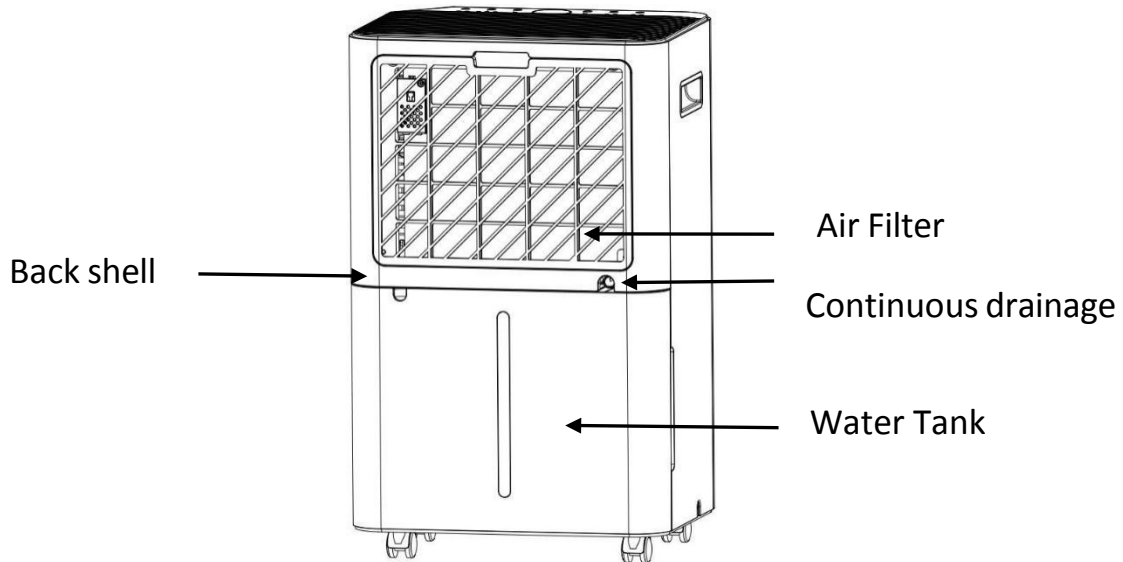

FEATURES

- Powerful moisture removal (up to 20L/day dehumidification)
- Humidity Monitor shows current air humidity
- Auto mode adjusts humidity levels
- 24-hour timer to set the time of operation
- Effectively remove moisture, dust from the air
- Low power consumption-energy efficient
- Quiet fan has two speed settings
- Auto-Defrost at low temperature
- Auto shut-off/ auto restart
- Electronic control
- Nylon Filter
- Continuous drainage or 4.5L water tank

3.0 FOR YOUR SAFETY

3.1 OPERATIONAL PRECAUTIONS

THE FOLLOWING SHOULD ALWAYS BE OBSERVED FOR SAFETY

- This appliance can be used by children aged from 8 years and above and persons with reduced physical, sensory or mental capabilities or lack of experience and knowledge if they have been given supervision or instruction concerning use of the appliance in a safe way and understand the hazards involved. Children shall not play with the appliance. Cleaning and user maintenance shall not be made by children without supervision.
- The unit is designed only for use with R-290 (propane) gas as the designated refrigerant.
- The refrigerant loop is sealed. Only a qualified technician should attempt to service!
 - R-290 (propane gas) is flammable and heavier than air.
 - It collects first in low areas but can be circulated by fans.
- If R-290 (propane gas) is suspected, do not allow untrained personnel to attempt to find the cause.
 - The R-290 (propane gas) used in the unit has no odour.
 - The lack of smell does not indicate a lack of escaped gas.
- If a leak is detected, immediately evacuate all persons from the room/area, ventilate the room and contact the local fire department to advise them that a propane leak has occurred.
- Do not let any persons back into the room until a qualified service technician advises that it is safe to return to the store.
- No open flames, cigarettes or other possible sources of ignition should be used inside or in the vicinity of the units.
- Component parts are designed for propane and non-incentive and non-sparking. Component parts shall only be replaced with identical repair parts.

FAILURE TO ABIDE BY THIS WARNING COULD RESULT IN AN EXPLOSION, DEATH, INJURY AND PROPERTY DAMAGE

WARNING- to reduce the risk of fire, electric shock or injury to persons or property:

- If the supply cord is damaged, it must be replaced by the manufacturer, its service agent or similarly qualified persons in order to avoid a hazard.
- Always operate the unit from a power source of AC220-240V, 50Hz and maximum 160W as indicated on the product identification plate.
- Always use a power outlet that is grounded.
- Unplug the power cord when cleaning or when not in use.
- Do not operate with wet hands. Prevent water from spilling onto the unit.
- Do not immerse or expose the unit to rain, moisture or any other liquid.
- Do not leave the unit running unattended. Do not tilt or turn over the unit.
- Do not unplug while the unit is operating.
- Do not unplug by pulling on the power cord.
- Do not use an extension cord or an adapter plug.
- Do not put objects on the unit.
- Do not climb or sit on the unit.
- Do not insert fingers or other objects into the air outlet.
- Do not touch the air inlet or the aluminum fins of the unit.
- Do not operate the unit if it is dropped, damaged or showing signs of product malfunction.
- Do not clean the appliance with any chemicals.
- Do not cover the air filter or air outlet.
- Ensure the unit is far away from fire, inflammable, or explosive objects.
- Do not use means to accelerate the defrosting process or to clean, other than those recommended by the manufacture.
- The appliance must be stored in a room where there are no continuously operating sources (for example: open flames, an operating gas appliance or an operating electric heater).
- Do not pierce or burn, even after use.
- Be aware that refrigerants may not contain an odour.
- Pipework shall be protected from physical damage and shall not be installed in an unventilated space, if that space is smaller than 4m².
- Compliance with national gas regulations shall be observed.

- Keep any required ventilation openings clear of obstruction.
- When not in use the appliance must be stored in a well-ventilated area where the room size corresponds to the room area as specified for operation.



Any person who is involved with working on, or breaking into a refrigerant circuit, should hold a current valid certificate from an industry-accredited assessment authority, which authorises their competence to handle refrigerants safely in accordance with an industry, recognized assessment specification.



Servicing shall only be performed as recommended by the equipment manufacturer. Maintenance and repair requiring the assistance of other skilled personnel shall be carried out under the supervision of the person competent in the use of flammable refrigerants. If you don't understand something or need help, please contact the TCP helpline.

3.2 SAFETY PRECAUTIONS ON SERVICING

Please follow these warnings when to undertake servicing of a dehumidifier with R290.

Checks to the surrounding area

Prior to beginning work on systems containing flammable refrigerants, safety checks are necessary to ensure that the risk of ignition is minimized. For repair to the refrigerating system, the following precautions shall be complied with prior to conducting work on the system.

Work procedure

Work shall be undertaken under a controlled procedure to minimize the risk of a flammable gas or vapor being present while the work is being performed.

General work area

All maintenance staff and others working in the local area shall be instructed on the nature of work being carried out. Work in confined spaces shall be avoided. The area around the workspace shall be sectioned off. Ensure that the conditions within the area have been made safe by control of flammable material.

Checking for presence of refrigerant

The area shall be checked with an appropriate refrigerant detector prior to and during work, to ensure the technician is aware of potentially flammable atmospheres. Ensure that the leak detection equipment being used is suitable for use with flammable refrigerants, i.e. no sparking, adequately sealed or intrinsically safe.

Presence of fire extinguisher

If any hot work is to be conducted on the refrigeration equipment or any associated parts, appropriate fire extinguishing equipment shall be available to hand. Have a dry powder or CO₂ fire extinguisher adjacent to the charging area.

Ignition sources

No person carrying out work in relation to a refrigeration system which involves exposing any pipe work that contains or has contained flammable refrigerant shall use any sources of ignition in such a manner that it may lead to the risk of fire or explosion. All possible ignition sources, including cigarette smoking, should be kept sufficiently far away from the site of installation, repairing removing and disposal, during which flammable refrigerant can possibly be released to the surrounding space. Prior to work taking place, the area around the equipment is to be surveyed to make sure that there are no flammable hazards or ignition risks. "No Smoking" signs shall be displayed.

Ventilated area

Ensure that the area is in the open or that it is adequately ventilated before breaking into the system or conducting any hot work. A degree of ventilation shall continue during the period that the work is carried out. The ventilation should safely disperse any released refrigerant and preferably expel it externally into the atmosphere.

Checks to the refrigeration equipment

Where electrical components are being changed, they shall be fit for the purpose and to the correct specification. At all times the manufacturer's maintenance and service guidelines shall be followed. If in doubt consult the manufacturer's technical department for assistance.

The following checks shall be applied to installations using flammable refrigerants:

- The charge size is in accordance with the room size within which the refrigerant containing parts are installed;
- The ventilation machinery and outlets are operating adequately and are not obstructed;
- If an indirect refrigerating circuit is being used, the secondary circuit shall be checked for the presence of refrigerant;
- Marking to the equipment continues to be visible and legible. Markings and signs that are illegible shall be corrected;
- refrigeration pipe or components are installed in a position where they are unlikely to be exposed to any substance which may corrode refrigerant containing components, unless the components are constructed of materials which are inherently resistant to being corroded or are suitably protected against being so corroded.

Checks to electrical devices

Repair and maintenance to electrical components shall include initial safety checks and component inspection procedures. If a fault exists that could compromise safety, then no electrical supply shall be connected to the circuit until it is satisfactorily dealt with. If the fault cannot be corrected immediately but it is necessary to continue operation, an adequate temporary solution shall be used. This shall be reported to the owner of the equipment so all parties are advised.

Initial safety checks shall include:

- those capacitors are discharged: this shall be done in a safe manner to avoid possibility of sparking;
- that there no live electrical components and wiring are exposed while charging, recovering or purging the system;
- that there is continuity of earth bonding



4.0 INSTALLATION

4.1 LOCATION

1. Place the unit on a firm, level surface in an area with at least 30cm of free space around it to allow for proper air circulation.
2. Never place the unit where it could be subject to:
 - Heat sources such as radiators, heat registers, stoves or other products that produce heat.
 - In an area where oil or water may be splashed
 - Direct sunlight
 - Mechanical vibration
 - Excessive dust
 - Lack of ventilation, such as cabinet or bookcase

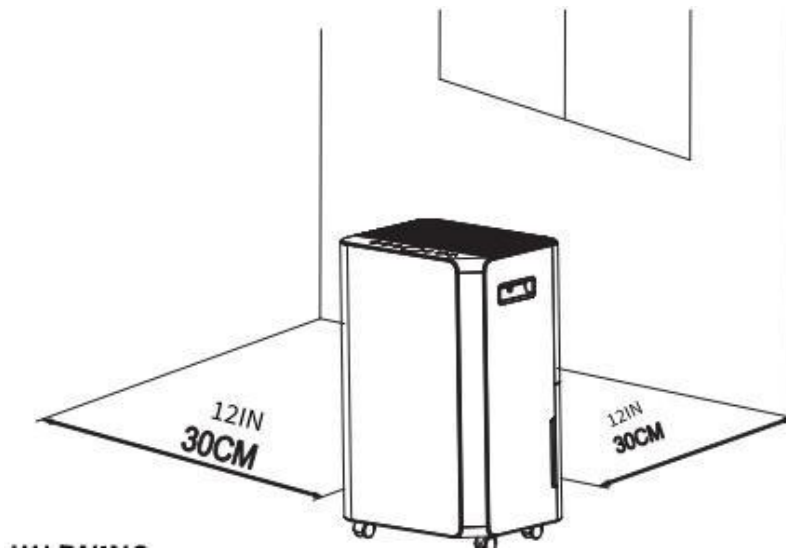

WARNING

Install the unit in rooms which exceed 4 m².

Do not install the unit in a place where inflammable gas may leak

NOTE

The manufacture may provide other suitable example or may provide additional information about the refrigerant odour.

5.0 OPERATING THE DEVICE SAFELY

5.1 SAFETY PRECAUTIONS WHEN USING THE DEVICE

- Check the device after unpacking for any damages or scratches on it.
- Operate this unit in an ambient temperature from 5°C to 35°C.
- Do not use outdoors. This dehumidifier is intended for indoor, residential applications only.
- Do not operate near walls, curtains, or other objects that may block inlet and outlet.
- Keep the air inlet and outlet free of obstacles.
- If tipped more than 45°, allow the unit to sit upright for at least 24 hours before start up.
- Keep doors and windows closed for better energy saving.
- Do not operate or store the unit in direct sunlight or rain.
- It is normal for air outlet to feel warm to touch after continuous operation on hot days.
- Empty the water tank before moving the device.
- Make sure the Water tank is correctly fitted otherwise the unit will not operate properly.
- The dehumidifier starts up in the mode selected when the unit was last used.
- The dehumidifier starts dehumidifying if the room humidity is 3% higher than the selected humidity.
- There is a protective 3-minute time delay of the compressor. Wait 3 minutes for the dehumidifier to resume dehumidification.

5.2 EMPTYING THE WATER TANK

There are two ways of removing collected water produced by the unit.

- A. Manual draining: Empty water tank by manual.
- B. Continuous draining: Use gravity to drain condensated water by attaching a drain hose.

When the water tank is full the unit will automatically shut down. It will start again once the water tank has been emptied and re-installed properly.

When the tank is full, the unit will make a buzzing sound, and the "Water Full" light will turn on

- Press the POWER button to turn off the unit.
- Pull the water tank and simply slide out of the body of the dehumidifier.
- Empty the water into an area with a drain or outside.
- Clean the inside of the tank as well as the outside.
- Replace the empty tank back into the unit.
- Press the POWER button to resume operating.

If the Water Full light does not extinguish, check that the float is correctly in place.

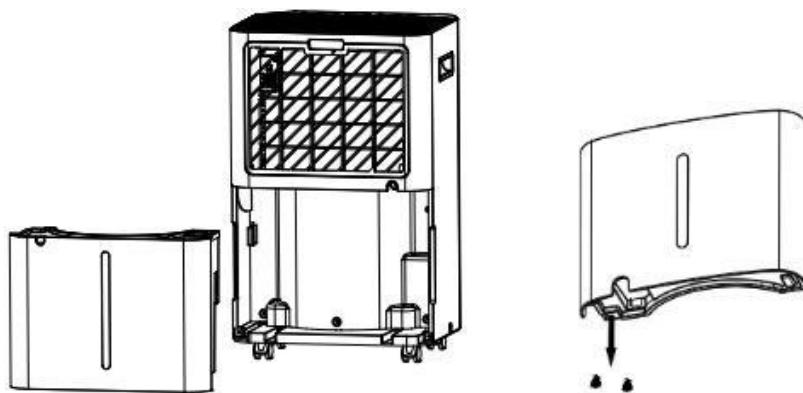

5.3 CONTINUOUS DRAINING

For continuous operation or unattended dehumidification, please connect the attached drain hose to the unit. Condensate water can be automatically flow into a bucket or drain by gravity.

Set the unit in a horizontal surface and stable position.

Switch off the unit before operating.

Securely and properly connect the drain hose and make sure it is not kinked and clear of obstruction.

Place the outlet of hose over a drain or bucket and ensure that water can freely flow out of the unit.

Do not submerge the end of hose into water; this can cause an "Air Lock" in the hose.

drain-pipe

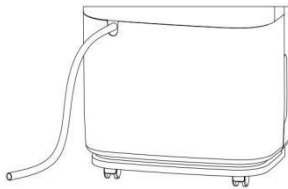

To avoid water spillage:

As the negative pressure of condensate drain pan is large, tilt the drain hose downward toward the floor. It is appropriate that the degree of inclination should exceed 20 degrees.

Straighten the hose to avoid a trap existing in the hose.

6.0 MAINTENANCE

6.1 **CLEANING THE AIR FILTER** (every two weeks, or if notably dusty)

Dust collects on the filter and restricts the airflow. The restricted airflow reduces the efficiency of the system and if it becomes blocked it can cause damage to the unit.

The air filter requires regular cleaning. The air filter is removable for easy cleaning. Do not operate the unit without an air filter, or the evaporator may be contaminated.

1. Remove the air filter frame.

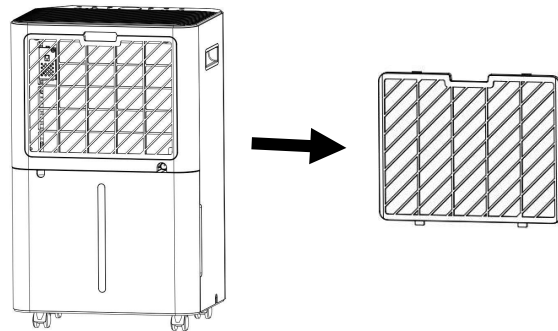

2. Use a vacuum cleaner to gently absorb the dust on the surface. If the filter is very dirty, wash it with water and a soft detergent and allow it to dry thoroughly before replacing back into the unit.

3. Put the filter back on to the unit.

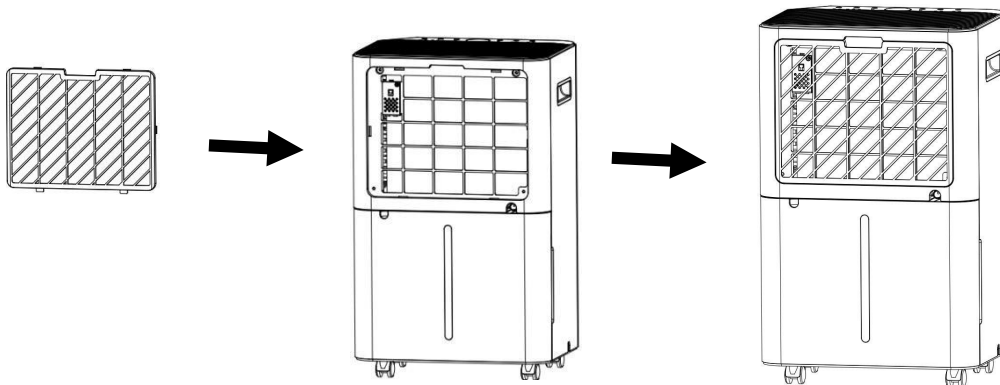

7.0 TROUBLE SHOOTING

7.1 FUNCTIONING TEMP

Temperature is between 5°C and 35°C

When the ambient temp is lower or higher than the functioning temp, the dehumidifier stops.

Temperature is between 5°C and 16°C

The compressor automatically defrosts at intervals; during defrosting, the compressor stops and the fan keeps running.

7.2 BEFORE CALLING FOR SERVICE

Before contacting professional service, please review the trouble shooting list that includes common occurrences that are not the result of a defect in workmanship or materials.

Problem	Possible Cause	Solution
Not working	No power supply	Connect to a functioning outlet and switch on
	Water Full Indication Flashes	Drain water tank and reset it, or re-position the water tank to right place
	Room temperature below 5°C, or above 35°C	Self-Protection designed to protect the unit.
Not functioning correctly	Is the air filter clogged?	Clean the air filter as instructed
	Is the intake duct or discharge duct obstructed?	Remove the obstruction from the discharge duct or intake duct.
No air intake	Is the filter clogged?	Wash the filter
Loud noise when running	Is the machine on flat ground?	Put the machine on the flat ground
	Is the filter clogged?	Wash the filter
E2	Humidity sensor problem	Change the sensor
LO	Environmental humidity is below 20%	The dehumidifier shuts down for self-protection
HI	Environmental humidity is above 90%	
CL	Low temperature protection, the environmental temperature < 5°C	
CH	High temperature protection, the environmental temperature > 35°C	

8.0 DECOMMISSIONING

8.1 STORAGE

Long-term storage - If you will not be using the unit for an extended period of time (more than a few weeks) it is best to clean the unit and dry it out completely. Please store the unit per the following steps:

- Press power button to switch off and unplug the unit.
- Drain the remaining water from the unit.
- Clean the filter and let the filter dry completely in a shaded area.
- Collect the power cord at the water tank.
- Re-install the filter in its correct position.
- The unit must be kept in upright position when in storage.
- Store the unit in a well -ventilated, dry, safe place indoors. Ensure the area does not contain any corrosive gas.

ATTENTION:

The evaporator inside the machine has to be dried out before the unit is packed to avoid component damage and mould. Unplug the unit and place it in a dry open area for a few days to dry it out. Another way to dry the unit is to set the humidity point more than 5% higher than the ambient humidity to force the fan to dry the evaporator for a couple of hours.

8.2 DISPOSAL

WARNING!!!

Releasing refrigerant into atmosphere is strictly forbidden!

Only dispose of electrical appliances as designated municipal waste facilities. Contact your local government for information regarding the collection systems available. If electrical appliances are disposed of in landfills or dumps, hazardous substances can leak into the groundwater and get into the food chain.



9.0 OPERATION

9.1 CONTROL PANEL

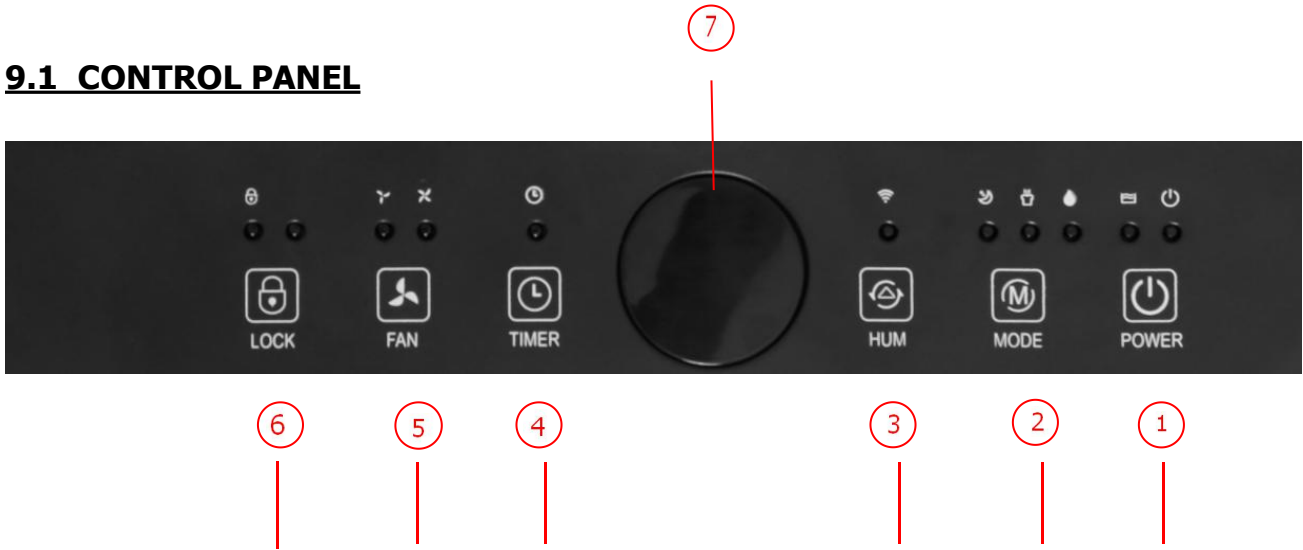

9.2 FUNCTION KEYS AND INDICATORS

1.	POWER button	Touch this button to switch the machine on or off.
2.	Mode Button	Touch this button to choose Auto, Sleep and Continuous Dry mode.
3.	HUM Button	Touch this button to adjust the humidity level and choose timer hour
4.	Timer button	Touch this button to set a time for the unit to automatically start or stop. Through long press the button to active WIFI connection
5.	Fan speed button	Touch this button to select fan speed between high and low.
6.	Lock button	Hold this button to turn child lock function on or off.
7.	Digital Display	Displays humidity value, Timer setting or Temperature.



Power button

In the standby state, touch this button to turn on, the operation indicator lights up and the default fan speed is high, and the default humidity is 50%. In the power-on state, touch this button to turn off, the running indicator light goes off and the compressor stops immediately, and then the fan shuts down after 30 seconds delay.



Dehumidify Mode

Touch the mode key to switch between automatic, sleep and dry mode. Press once to switch the mode from one to another, the corresponding indicator lights up.

Auto Mode: when environmental humidity is +3° higher than the set humidity, the fan starts working; the compressor starts working after 3 seconds.

When environmental humidity is -3° lower than the set humidity, the compressor stops working and fan stops working after 30 seconds' delay.

Both fan speed and humidity can be adjusted under auto mode.

Continuously Drying Mode: In this mode, the machine will continue to run in high fan speed; the compressor keeps working without control due to the humidity. Fan speed is adjustable but humidity is not adjustable

Sleep Mode: Touch the sleep button, the button lights up and start the sleep function; the default humidity is 50%. After no operation for 10 seconds, all indicators turn dark gradually and the fan speed is automatically switched from high to low. Press any button to wake up the indicator. Touch sleep button again to exit the sleep mode.

When environmental humidity is equal to or greater than 57% , the compressor stops working and the fan shut down after 30 seconds' delay.

When environmental humidity is equal to or less than 63%, the fan starts working and compressor starts working after 3 seconds.

Fan speed and humidity cannot be adjusted under sleeping mode.

In sleeping mode, when the water tank is full, the machine will not alarm but the trouble code will display darkly as a reminder to empty water tank.



Timer button

Press the timer button to set the 00-24 hour timing function. Display panel "88" flashes and will show timer hour. To increase the time by 1 hour touch hum

button"  The value will be displayed on the display screen.

In the running state, use the timer function to turn off the machine regularly. In the standby state, use the timer function to turn on the machine regularly.

Set the time to "00" to cancel the timing function.



Fan Speed

High speed - low speed cycle. Touch the button once to switch and then the corresponding indicator lights up.



Child lock

Press for more than 3 seconds to turn on/off the child lock function.

Water Tank Full Alarm

Tank Indicator

When the tank is full the water tank indicator turns red and the unit buzzes 5 times.

Clear the alarm

When the buzzer is on, touch any button to stop it. The compressor and fan will shut down and all the functions will freeze until the tank is emptied and back in right position.

10.0 CONNECTING THE APPLIANCE TO WIFI

Use the QR code below to download the TCP Smart App for control of the dehumidifier by voice or TCP Smart App.

QR code for both android and iOS



To control the dehumidifier using the TCP Smart App the unit must be turned on.

Before you get started you will need the following:

- Smart device such as a mobile phone
- Access to the Google Play or Apple App store, log on and passwords
- The name of your Wi-Fi network and password to your Wi-Fi network
- Confirm your home Wi-Fi router is running on 2.4Ghz and not 5Ghz. If you are unsure, please consult your broadband provider for details on how to change the settings.
- Turn off any Wi-Fi extenders during set up
- Check you do not have any limitations on the number of devices with your broadband provider

Please note: Our products do not work on 5Ghz only 2.4Ghz.

Turn on the dehumidifier using the power indicator, the WiFi indicator will flash. The device is now in pairing mode. In the TCP Smart App, enter your WiFi password and follow the instructions in the App to connect.

After 3 minutes, the status will be canceled if there is no network configuration, and the indicator light is off. If you need to re-connect the WiFi, hold the "timer" button for 5 Seconds to start the set up again, the WiFi indicator will flash again.

Alternatively, the device can be connected to the TCP Smart App when pairing for the first time. Ensure the Bluetooth on your device is open. Open the TCP Smart app and the unit will connect automatically.

Once the appliance has been successfully connected, the WIFI lamp lights up. Now you can operate the appliance using the app.

Press and hold the Timer button for about 5 seconds, the appliance will disconnect from WiFi and the WiFi lamp indicator light will turn off.

11.0 USING THE TCP SMART APP

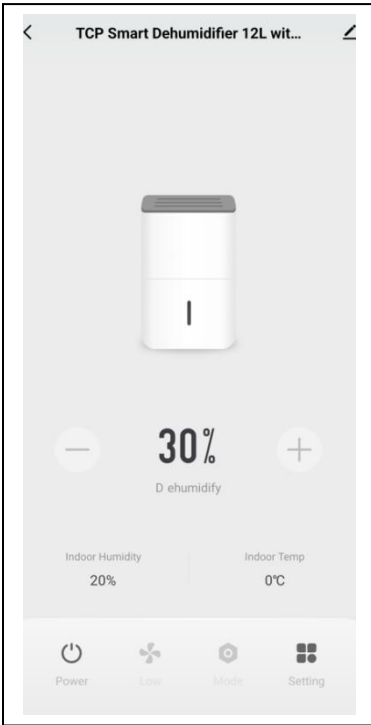

Device Control Screens



– Turn device on and off. When On indicator light is Green, when Off indicator light is black



Change dehumidifying percentage



- Fan Speed– Select High or Low or Cancel. The selection of high or low will be shown under the symbol



- Choose Dehumidify, Drying or Sleep mode



- Select to add scheduling or Child Lock

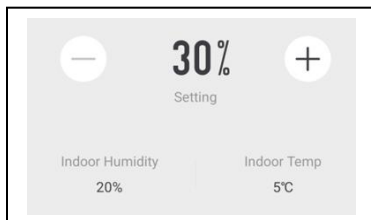

Manually selected humidity levels –

The dehumidifier starts dehumidifying the room if the room humidity is +3% higher than then selected humidity. Note the indoor humidity level and set the humidity level to be 3% lower than the indoor level for the dehumidifier to start working

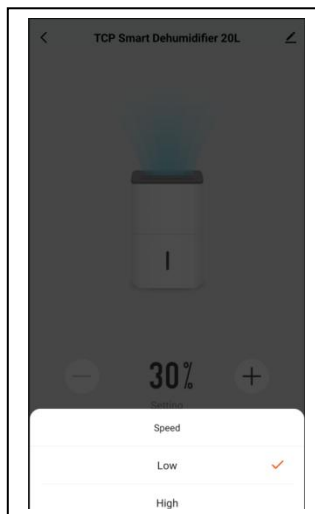

Fan speed



Select speed – Low, High or Cancel

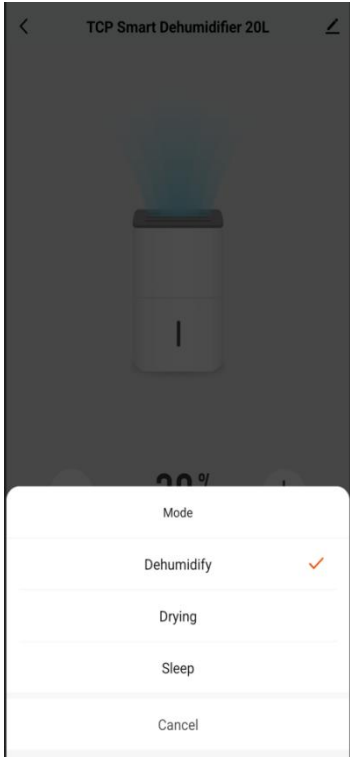

Dehumidify mode

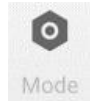

Dehumidify – this will start the dehumidifying function if the selected humidity level is 3% lower than the recorded indoor humidity - see manually selected humidity levels above.

Drying Mode - In this mode, the machine will continue to run in high fan speed; the compressor keeps working without control due to the humidity. Fan speed is adjustable but humidity is not adjustable

Sleep Mode – The default humidity is 50%. After 10 seconds of no operation, all the indicator lights will gradually turn dark and the speed is automatically switched from high to low. Fan speed and humidity cannot be adjusted when in sleep mode. Press either of the other 2 functions to exit sleep mode.

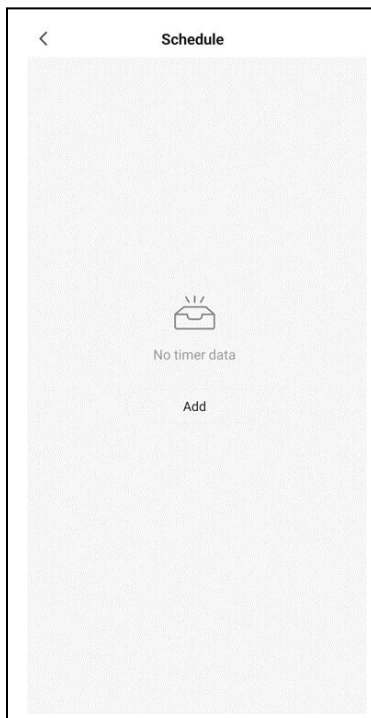
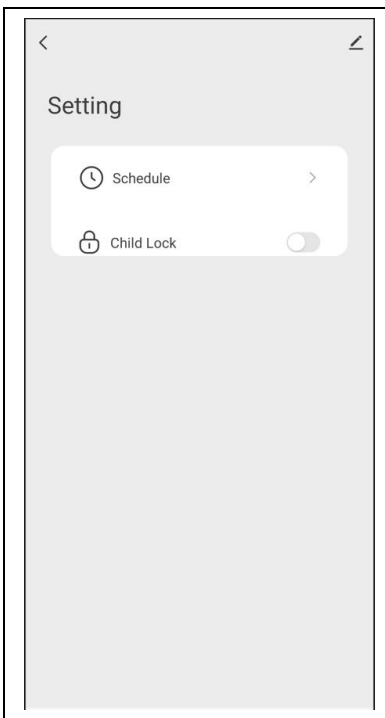

Settings Mode



Select Child Lock -by tapping button. Tap again to turn off.

Schedule – operate the schedule by pressing schedule. To add a schedule press the add button

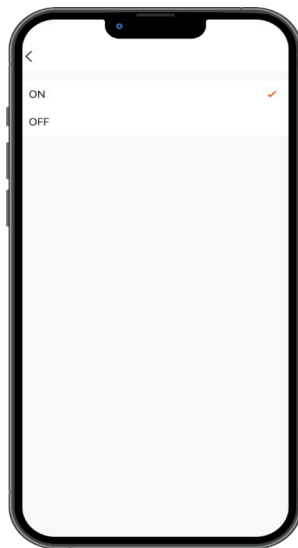
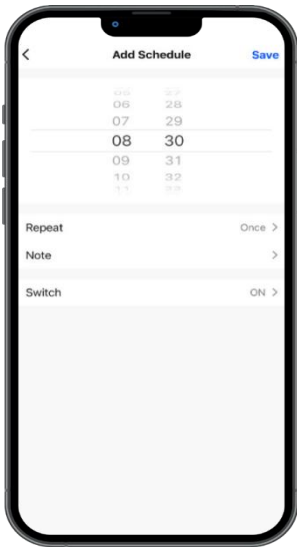

To add just one occurrence, select the time you want to start the heater, press Switch and select on. Press Done followed by Save.

Select the time you want the dehumidifier to turn off, press Switch and select off. Press Done followed by Save.

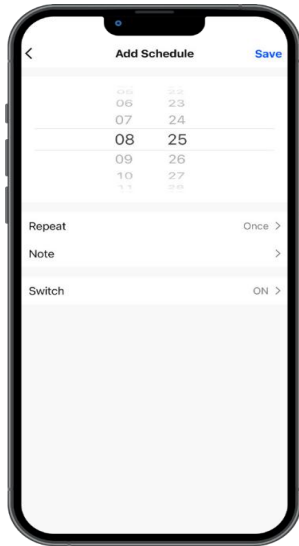
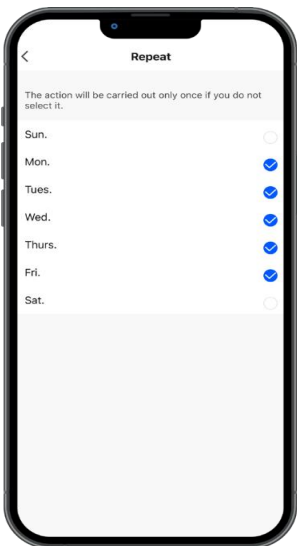

WEEKLY SCHEDULE

To turn the heater on for specific day(s) and time(s).

Press repeat to show days of the week. Tick the day(s) of the week you want the heater to turn on.

Press < button on top left hand of the screen.

To receive a notification to your phone to alert when the schedule has activated, before saving press Notification.

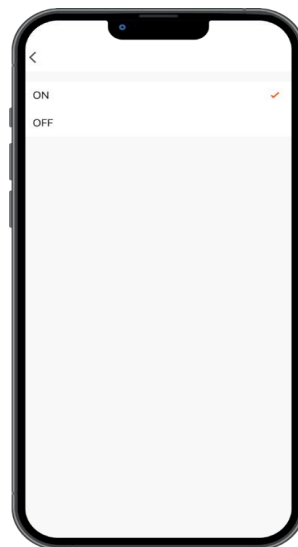
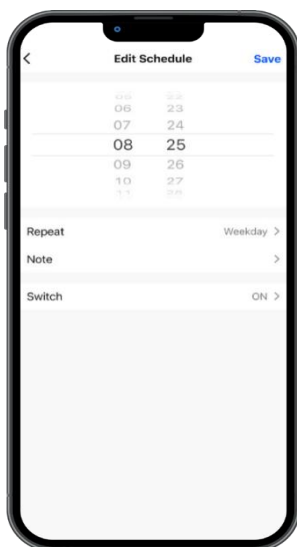

Select the time you want the dehumidifier to start. Press Switch. Press on followed by Done. Press Save

To turn the dehumidifier off, press the repeat button to show the list of days.

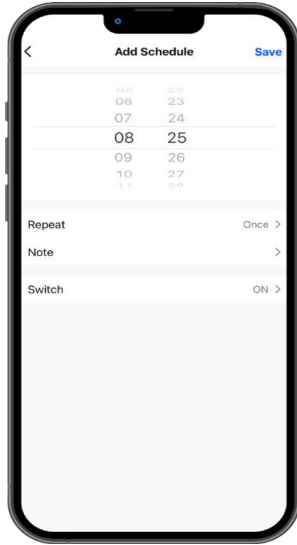
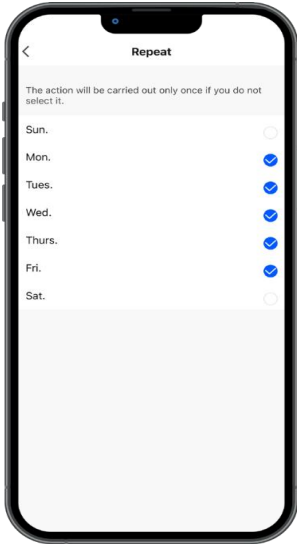

Tick the same day(s) you selected to turn the dehumidifier on.

Press the < button on top left hand of the screen.

Select the time you want the dehumidifier to turn off.

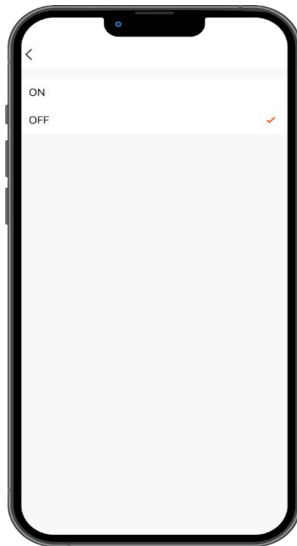

Press Switch followed by off.
Press Done followed by Save.

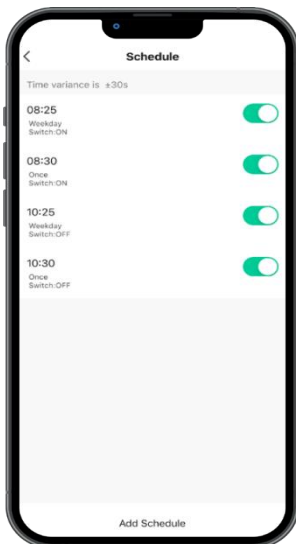

This screen will list the times and dates you have selected to turn the dehumidifier on and off.

Press < button to return to the previous screen.

GUARANTEE INFORMATION

The manufacturer provides guarantee in accordance with the legislation of the customer's own country of residence, with a minimum of 2 years, starting from the date on which the appliance is sold to the end user.

The guarantee only covers defects in material or workmanship.

The repairs under guarantee may only be carried out by an authorized service centre. When making a claim under the guarantee, the original bill of purchase (with purchase date) must be submitted. The guarantee will not apply in cases of normal wear.

CERTIFICATION CONFORMITY

Hereby, Technical Consumer Products Ltd declares that the radio equipment type TCP Smart Dehumidifier 12L is in accordance with Directive 2014/53/EU.

The full text of the EU declaration of conformity is available at the following internet address – <https://tcpj.eu/compliance-data/>

REGISTERED OFFICES

TCP UK Ltd, 1 Exchange Court, Cottingham Road, Corby, Northants, NN17 1TY. Tel: 01536 201503.
TCP France, Quai Gabriel P'ri, 1, Joinville Le Point, France, 94340.

