

Tips

Before you start...

- Check your Alloy panel for damage or imperfections.
- Read the entire installation guide and decide on the installation method you plan to use
- Ensure you have all of the tools and materials required.
- Measure the designated area for your Alloy panel to ensure you have enough material
- Ensure receiving surfaces are clean and smooth.
- If using Alloy behind a cooking hob, ensure a minimum 30mm distance is maintained between the panel surface and the closest edge of the hob.
Please note, this advice does not supersede that given by your appliance manufacturer and you must always follow manufacturer instructions around the distance between your appliance and other items.
- Do not remove the protective film from the back of your splashback until after you have cut to size and are ready to apply adhesive.

During installation...

- Ensure you wear the appropriate Personal Protective Equipment throughout installation.
- Always complete a dry fit between cut and installation.
- Take care and use a two-man lift when moving panels.

Tools

- Tape measure
- Sand paper
- Masking tape
- Spirit level
- Complete adhesive
- Complete sealant (or clear silicone)
- Sealant gun
- 1.5mm packers
- Metal file
- Metal seam roller
- Circular saw with new aluminium cutting blade
- Handheld router
- Electric drill with HSS drill bit
- Jig saw with new aluminium cutting blade
- Guide rail for circular saw



Sheet Inspection

The first step is to inspect your Alloy panel for damage or imperfections prior to installation, being sure to check the Alloy surface for scratches or drag marks. If you find damage, unless the damage can be removed, do not work with the panel. Instead, please contact your supplier.

If you are installing multiple Alloy panels next to each other, please check for colour variation before commencing. If there is colour variation, please contact your supplier.

Installation Methods

Hob Panel Only

If you're installing a Hob Panel only, centre it with your appliance and adhere to the wall.

Joining Panels Together

If using more than one panel, join them with a plate before adhering to the wall as one. We recommend using a jointing plate every time you are joining two panels together, regardless of using trims. This method ensures your panel joint remains tight, great for walls that aren't completely flat.

Fitting with a Butt Joint

This is the easiest and fastest method. Flat panels meet at the corner with a butt joint.

Fitting with a Profile Finish

For a superior finish, use a profile. The panel is finished with trims, then adhered to the wall.

Fitting External Corners with Profiles

Use an external corner profile to join two panels meeting at an external corner

Fitting Internal Corners with Profiles

Use an internal corner profile to join two panels meeting at an internal corner.

Fitting a Hob Panel Only

If you are fitting a hob panel only, carry out a dry fit of the panel by placing it against the wall without applying adhesive.

Once happy with the fit, remove the protective film from the back of the panel. Leaving a 40mm perimeter around the edge adhesive-free, apply Complete adhesive in zig zag motions.

Apply the panel to the wall and follow Complete adhesive guidelines. Once cured, edge all around with Complete sealant.

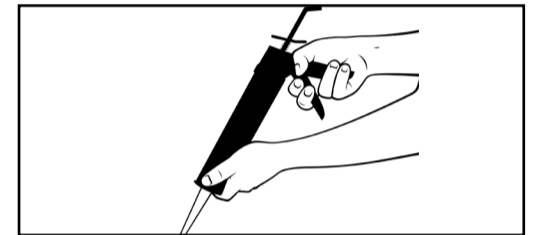

Fig. 1

Measuring

Do not remove the protective film from your panel until after you have cut to size and are ready to apply adhesive.

Measure the width of the horizontal space (A) where the panels will be installed, then measure the vertical space (B) between the worktop and cooker hood and finally the vertical space (C) between worktop and upper cabinets.

You must allow 1.5mm at the top, bottom and each side of the Alloy panel for thermal expansion. For example, if your measurement is 2000mm across and 600mm high, your final measurement is 1997mm across, and 597mm high. This allows for the necessary 1.5mm expansion on every side.

If there are sockets on the wall, take the exact measurement of their position. Remove the socket from the wall, and measure around the back box of the socket on the wall. Add 1.5mm to the measurement to allow for thermal expansion. For example, if your socket back box is 147mm across and 87mm high, your final measurement for the socket cut out is 150mm across and 90mm high. This allows for the necessary 1.5mm expansion on every side.

Remember that electrical works must be carried out by a certified electrician.

Once your measurements are complete, you can transfer them onto the back of the panel, without removing the protective film, by placing masking tape where you need to make a pencil mark.

Repeat the steps for every wall.

Remember to measure twice, and cut once.

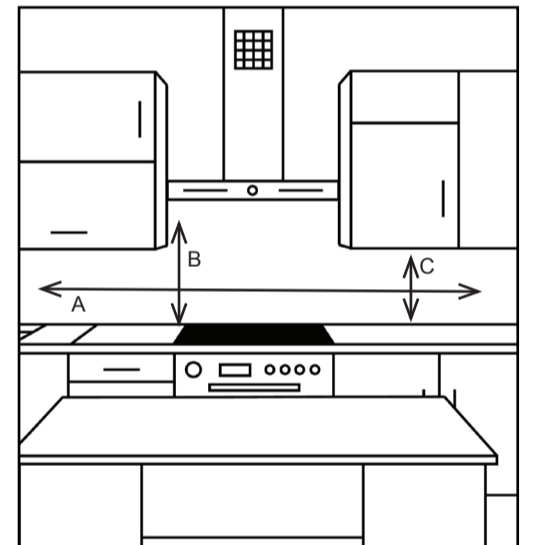

Fig. 2

Cutting and Finishing

Always support the panel fully on a clean, flat surface. Ensure the decorative side of the panel is the correct way up, depending on what type of circular saw you are using, and what direction the saw blade is rotating. Before you start, check nothing beneath the panel will damage or scratch the surface, and that nothing can be damaged by your work. **Important: if it is necessary to cut your panels to size, it is very important to be aware that any newly cut edge will be very sharp and must be finished.** Cutting to size should only be carried out with a circular saw and not a jig saw.

Check your measurements before cutting, and remember to leave a 1.5mm allowance for thermal expansion. Use a circular saw with a new aluminium cutting blade to cut your panel to size. Cut so that the blade cuts up through the front of the splashback. Remember to measure twice and cut once.

Finishing: After cutting, it is essential to deburr cut edges to create a slight bevel to both top and bottom, using a wooden block with either 300 or 400 grit sand paper. Angle your block and sand with a few passes across the entire length, creating a slight bevel. In doing so, you will be left with a clean, straight edge and you will remove any possible blade wobble left by cutting. **Important: Do not use a deburring bladed tool or a rotary tool for this purpose.**

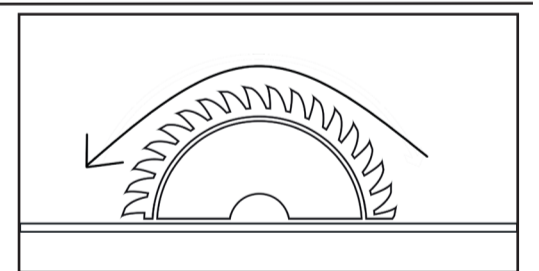

Fig. 3

Cutting Plug Sockets

Check your measurements before cutting, and remember to leave a 1.5mm allowance for thermal expansion.

With the outline of the plug socket back box marked out, drill a hole in each corner of the socket space using a HSS drill bit at least 10mm in diameter. Once holes are drilled, join each hole using a jig saw with a new aluminium cutting blade.

Remember to measure twice, and cut once.

Remember that electrical works should be carried out only by a certified electrician.

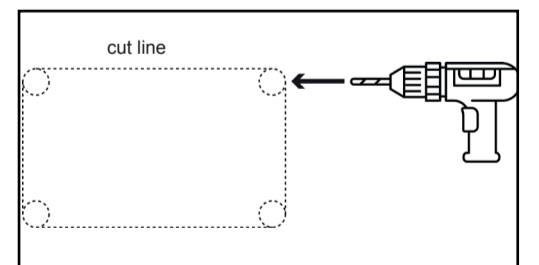

Fig. 4

Fitting with a Butt Joint without Joint Accessory

Once cut, carry out a dry fit of the panel by placing it against the wall without applying adhesive. Once happy with the fit, remove the protective film from the back of the panel.

Leaving a 40mm perimeter around the edge adhesive-free, apply Complete adhesive in zig zag motions.

Apply to the wall, using packers for the expansion gaps. If the panel is placed to meet another panel or a perpendicular wall, allow for a 1.5mm gap. Follow Complete adhesive guidelines. Once cured, remove packers and edge all around with Complete sealant.

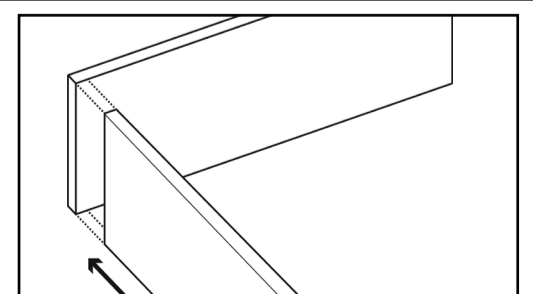

Fig. 5: Corner butt joint without internal joint accessory

Fitting with a Profile Finish

The profile method allows you to finish the edges of the splashback before attaching to the wall.

Cut your panel to size following the instructions above.

Once cut, carry out a dry fit of the splashback against the wall to ensure you are happy with the sizing.

Lay the splashback flat and fully supported with the decorative side face down. Using edge profiles, sold separately to your splashbacks, carry out a dry fit of your profiles on the top and sides of your splashback. Cut trims to size if necessary using a chop saw.

Once happy with the fit, remove the protective film from the back of the splashback and clean the back of the splashback with an alcohol wipe. Remove the double sided tape backer from the first profile and attach to the panel with the tape on the back. Repeat this step for each edge profile until the splashback is fully edged.

Carry out a dry fit of your splashback with profile(s) adhered to it, against the wall. Once happy, apply Complete adhesive to the back of the splashback in a zig zag, leaving a 40mm perimeter around the edge adhesive-free.

Apply the splashback to the wall, using packers for the expansion gaps. Follow Complete adhesive guidelines. Once cured, remove packers and edge all around with Complete sealant.

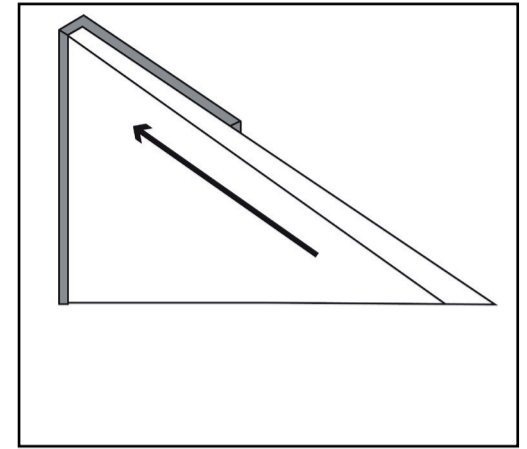

Fig. 6

Fitting with an External or Internal Corner Trim

Cut your panel to size following the instructions above. Once cut, carry out a dry fit of the pieces by placing them against the wall without applying adhesive.

Measure and mark your internal or external corner trim, then cut the trim to size if necessary using a chop saw. Without removing the tape from the trim, carry out a dry corner fit by placing both panel pieces against the wall with the trim in place.

Once happy with the fit, lay the splashback flat and fully supported with the decorative side face down. Remove the protective film from the back of the Alloy splashback and clean the splashback with the alcohol wipe.

Remove the double sided tape backer from one side of the trim, and carefully attach the taped side to the back of the Alloy splashback.

To attach to the wall in one piece: remove the double sided tape backer from one side of the trim and carefully attach the sticky side to the back of the Alloy panel. Manoeuvre the panel into a right angle and repeat the step for the second piece. Apply Complete adhesive to the back of the panel in a zig zag, leaving a 40mm perimeter around the edge adhesive-free. Apply the panel to the wall with the trim pushed against the corner, using packers for the expansion gaps. Follow Complete adhesive guidelines. Once cured, remove packers and edge all around with Complete sealant.

To attach to the wall in two steps, remove the double sided tape backer from one side of the trim and carefully attach the sticky side to the back of the Alloy panel. Apply Complete adhesive to the back of the panel in a zig zag, leaving a 40mm perimeter around the edge adhesive-free and apply the panel to the wall. Apply adhesive to the second panel, and slide it down into the trim from above, to meet the wall. Use packers for the expansion gaps. Follow Complete adhesive guidelines. Once cured, remove packers and edge all around with Complete sealant.

There may be instances where an edge profile needs to be installed close to an exposed internal or external corner. It is possible to make a small alteration for a neat fit. In this example the splashback will be fitted with a corner trim and finished with a profile trim on the top edge by creating interior or exterior 45 degree angles at the edges where the trims meet, and cutting a small gap in each profile trim to accommodate the corner trim, per Fig. 9.

Cut the internal or external corner profile to height and fix to the splashback following the instructions above. Establish which corner side each trim will be used on and the angle direction required. Using a mitre block or mitre saw, cut each profile edge at a 45 degree angle. This will allow the visible, narrow side of the trims to meet neatly at the corner. From the outermost corner of the trim, measure 35mm and mark the measurement on the double sided tape. This creates a small rectangle on the wide side of the trim where material will be removed, but the narrow lip above will remain. Using a junior hack saw, remove the small rectangle of material by cutting the wide side of the trim, leaving the narrow lip in tact. The top profile edge will now accommodate the corner trim and can be fitted to the wall following the instructions above, per Fig. 10.

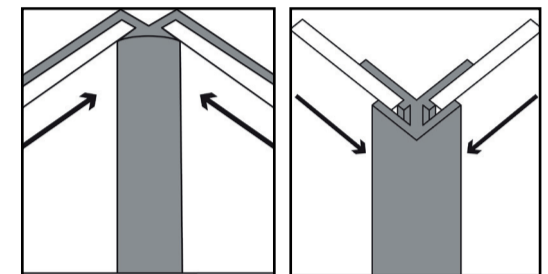

Fig. 7

Fig. 8

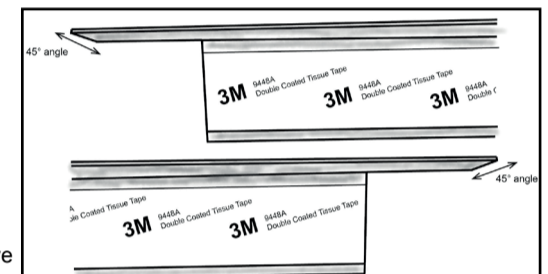

Fig. 9: Carefully create 45 degree angles to accommodate internal or external corner placement

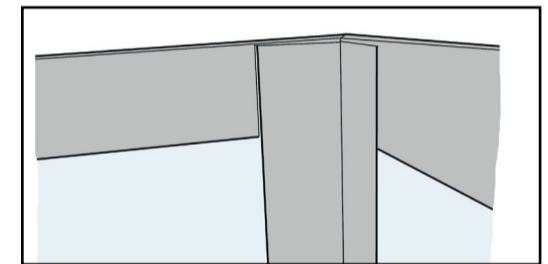

Fig. 10: view from the back of the panels

Joining Panels with a Jointing Plate

Before cutting and joining panels, make sure to align the print pattern between the 2 panels to be jointed. Always dry fit before installing.

If necessary cut your panels to size following the instructions above. Once cut, carry out a dry fit of the panels by placing them against the wall without applying adhesive. **Important: If it's necessary to cut your panels, please also follow the finishing instructions in the Cutting and Finishing section overleaf.**

Once happy with the fit, lay the panels flat face up and pull together to ensure you are happy with the join.

Once you are happy with the join, turn over panels and lay flat, fully supported with the decorative side face down. Remove the protective film from the back of the Alloy panel and wipe both sides of the join clean with an alcohol wipe.

To attach to the wall in one piece, peel the double sided tape backer off the jointing plate and carefully apply to both panels. Turn over the panels to check the join, and adhere to the wall using Complete adhesive in a zig zag with a 40mm perimeter.

To attach to the wall in two steps, peel one double sided tape backer off the jointing plate and carefully apply to one panel, leaving the second double sided tape backer in place. Adhere the single splashback to the wall using Complete adhesive in a zig zag with a 40mm perimeter, leaving half of the jointing plate visible. To attach the second panel, apply Complete adhesive in a zig zag with a 40mm perimeter, then remove the remaining double sided tape backer. Place the second splashback panel onto the wall against the jointing plate.

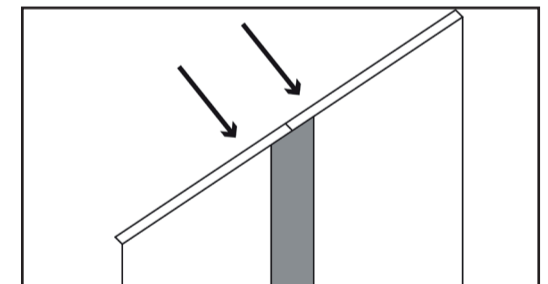

Fig. 11

Care and Maintenance

Alloy panels are tested for all aspects of durability, however like most wall surfaces it is vital that panels are cared for and correctly maintained to ensure the decorative finish is retained. There are some simple guidelines to follow to keep your Alloy panels looking great. Alloy splashbacks are suitable and safe for use behind hobs. To avoid any possible staining over time, a glass splashback can be used over the panels behind the hob installations.

Cleaning

- Any spills or splashes should be wiped away immediately. (especially harsh staining substances such as tea, coffee, curry and mustard)
- Alloy panels must only be cleaned regularly using a gentle household cleaner
- Splashes, oil and a build up of grime should be removed and wiped clean with a gentle household cleaner
- Only use a soft microfibre cloth or a non-abrasive cloth
- Do not use acidic, caustic or abrasive cleaning detergents or materials to clean the Alloy surface
- Do not use detergent with bleach or homemade remedy solutions like baking soda or other stain removing powders
- For harsh stains, a melamine cleaning sponge can be used

Placement and Everyday Use

- Avoid placing metallic or sharp objects against your Alloy splashback as this may pose risk of scratching
- Ensure boiling water and steam is directed away from the Alloy splashback as this may pose risk of damage
- If using Alloy behind a cooking hob, ensure a minimum 30mm distance is maintained between the panel surface and the closest edge of the hob.
- When cooking with open flame hobs do not allow flame to be in direct contact with the Alloy splashback.
- Avoid allowing hob flames to spread up pan sides towards the Alloy splashback.
- Always place a lid on pots or pans closest to the splashback

Please note, this advice does not supersede that given by your appliance manufacturer and you must always follow manufacturer instructions around the distance between your appliance and other items.

Storage

Before installation your splashback should be stored for 24 hours at normal room temperature (18°C - 25°C, relative humidity 50-65%).