



## WIFI TOWEL RADIATOR

TCP Smart WiFi app-controlled towel radiator is the perfect bathroom heating solution. This advanced towel radiator comes with Smart WiFi featuring 24/7 hour programming, with Comfort and Eco mode settings. The display panel can be fitted on either left or right side to suit your bathroom layout.

### USER INSTRUCTIONS

**MODEL**  
SMAWHTOWRAIL500W05EW  
SMABLTOWRAIL500W05EW

**POWER**  
AC220-240V 50-60Hz 500W Class II

**IMPORTANT:** These instructions are for your safety. Please read thoroughly before use and retain for future reference.

**If you are in any doubt about installing this product, consult a qualified electrician.**

### INSTALLATION INSTRUCTIONS

This product is suitable for indoor use only. It is IP24 rated. Do not submerge unit underwater. Do not attach to surfaces which are damp, freshly painted or otherwise electrically conductive (eg metallic surfaces).

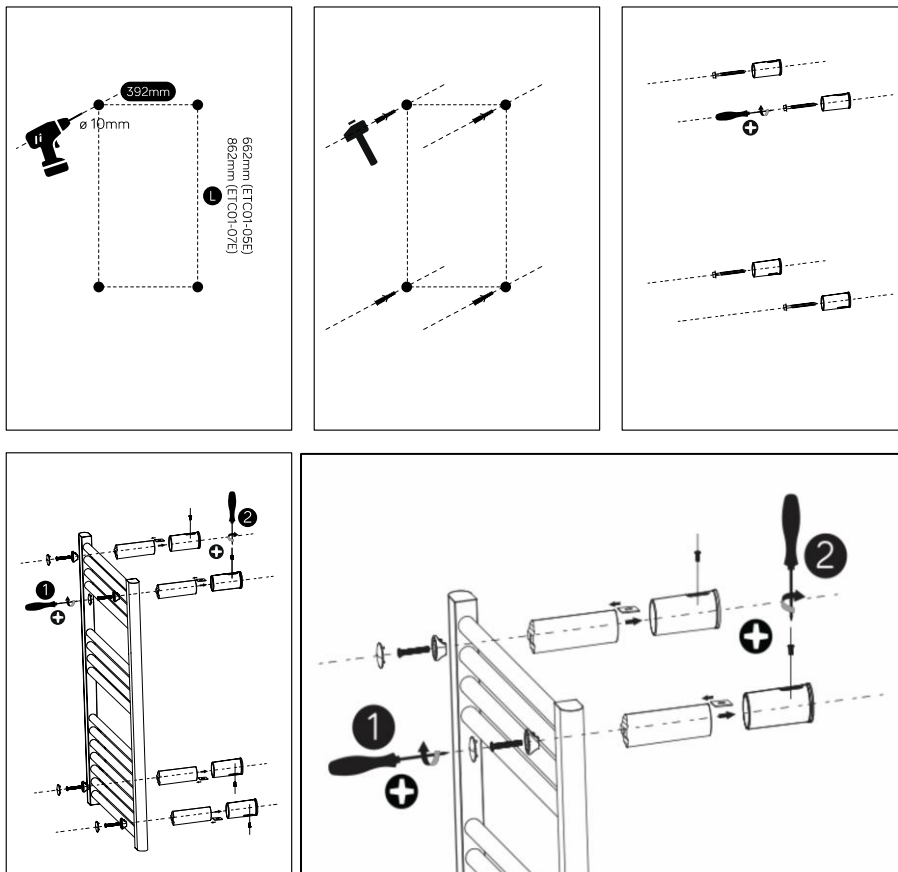

Please see above wall mounting instructions to ensure correct placement. Separate placement sheet is included in the box

1) Drill holes on the wall according to the above placements.

**Warning:** Be sure to keep to the distances as shown in the placement instructions.

2) Fit the fastener tube in the hole and fit the bracket on the wall with screws.

3) Carefully hang the unit on the bracket, then fix the unit with the lock and screw following above picture (step 1). Then fix the screw in step 2 by turning the lock in the bracket. Finish by covering screw heads with the cover.

**Warning:** Before using the heater, make sure it's mounted tightly on the wall.

## LOCATION OF INSTALLATION

This product can be installed in a bathroom but only in the area designated by the IP rating – Zone 3 – see location information below.

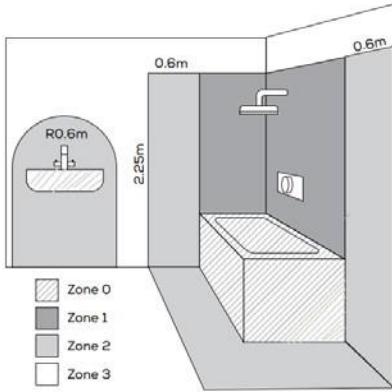

Suitable for indoor only. This product is rated as IP24. If the product is to be installed within a bathroom it can only be located within zone 3.

### Zone 0

The area inside a bath or inside the shower. This area requires low voltage and an IP67 rating.

### Zone 2

An area stretching 0.6m (1' 11") outside the perimeter where no water jet is likely to be used. In addition, it is good practice to consider the area around a wash basin, within a 60cm (1' 11") radius of any tap to be considered as zone 2.

### Zone 1

The area above the bath to a height of 2.25m (7' 4") from the floor. If the light is 240V then a 30ma residual current device (RCD) must also be used to protect the circuit in this zone.

### Zone 3

Anywhere outside Zones 0, 1, and 2 and where water jets are likely to be used. If there is a likelihood of water jets being used for cleaning purposes in zones 2 and 3 a fitting rated a minimum of IP65 must be used.

## WIRING INSTRUCTIONS

The power supply to the towel radiator must be protected in accordance with applicable standard by a 30mA differential Circuit-breaker, 16A rated. Before carrying out any connection tasks, cut off the power supply to the electronic regulator using the circuit-breaker or the protection fuse in the power supply circuit. This appliance does not come fitted/supplied with a fused plug. DO NOT wire/fit a plug to this appliance.

Means for disconnection having a contact separation in all poles must be incorporated in the fixed wiring in accordance with the wiring rules.

Connecting the power supply cable to the mains (220-240V AC)  
220v – 240V +10% - 10% 50Hz monophas power supply.

Warning: you need to connect the 2 wires of the supply cable to a connection block ensuring the mains polarity is followed as below:

**IMPORTANT:** The wire in the mains lead are coloured in accordance with the following code:

Blue – Neutral  
Brown – Live

The blue wire must be connected to the terminal marked with an N or coloured black.

The brown wire must be connected to the terminal marked with an L or coloured red.

**WARNING:** Never connect live or neutral wires to the earth terminal.

All fittings must be installed by a competent person in accordance with the current IEE Wiring Regulation (BS 7671). If in doubt, consult a qualified electrician.

## SAFETY INSTRUCTIONS (to be read before operating the heater).

- CAUTION:** Some parts of this product can become very hot and cause burns. Particular attention has to be given where children and vulnerable people are present. Children 3 years and younger should be continually supervised when in close proximity to the heater. Children aged from 3 to 8 years shall only switch on/off the appliance provided that it has been placed or installed in its intended normal operating position and they have been given supervision or instruction concerning use of the appliance in a safe way and understand the hazards involved. Children aged from 3 to 8 years shall not plug in, regulate and clean the appliance or perform user maintenance.
- Keep the power cord away from the hot body of the heater.

3. Indoor use only.
4. Do not use the heater in areas where flammable liquids are stored or where flammable fumes may be present.
5. Do not use this heater if it has been dropped;
6. Do not use if there are visible signs of damage to the heater;
7. Do not leave the heater switched on when your property is vacant.

## WARNINGS

- Always use the heater in an upright position.
- If the supply cord is damaged, it must be replaced by the manufacturer, their service agent or a similarly qualified person in order to avoid a hazard.
- In order to avoid a hazard due to inadvertent resetting of the thermal cut out, this appliance must not be supplied through an external switching device, such as a timer, or connected to a circuit that is regularly switched on and off by the utility.
- Always use this appliance with rollers fixed and ensure it is mounted tightly to the wall.

Control panel

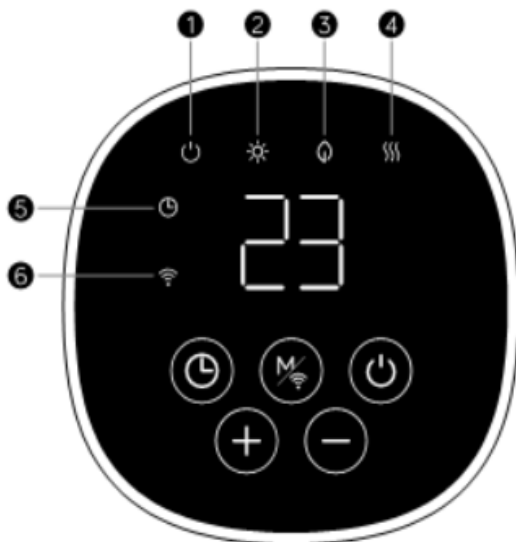

	Standby
	Mode selection
	Increase function
	Decrease function
	Timer off function

- ① Standby: on/off
- ② Comfort mode
- ③ ECO mode
- ④ Heating status
- ⑤ Timer
- ⑥ Wifi

# OPERATING THE RADIATOR

## Manual Settings using the LCD screen

Choose a suitable location for the radiator, taking into account the safety instructions above.

### ON/OFF BUTTON



Press once to turn the device on. Press again to turn the device off.

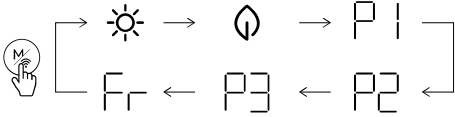

This feature can be performed using the TCP Smart App.

### MODE SELECTION

Press this button to cycle between the following options:





Press  to enter mode selection. By pressing , the heating mode runs in a continuous cycle as above:

 **Comfort mode:** Press  and  to set the temperature from 5-35°C.

 **ECO mode:** This is pre-set as 4°C below comfort mode.

 **Pre-programmed schedule** – Select to run the programme as stated below.

 - **Anti-frost mode.** To avoid damage to the product during extreme cold weather use anti-frost mode. The heater must be turned on and Anti Frost mode selected for this function to work. The screen will display . The target temperature is 7°C. The temperature cannot be adjusted.

 **Pre-Programmed scheduling** - Select to run the programme as stated below.

 **Programmable scheduling** – Select to create a programme to suit your own requirements.

This feature can be performed using the TCP Smart App.

### **P1, P2 and P3 Programmed scheduling** –

- Note: Clock and day of the week setting must be done for the below scheduling to work.

 (Monday-Sunday) Pre-programmed schedule. Please note: this schedule cannot be adjusted.

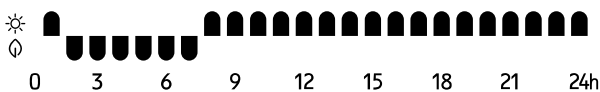

- 00:00am – 01:00am  comfort mode,

- 01:00am – 07:00am  ECO mode

- 07:00am – 00:00am  comfort mode.

**P2** (Monday-Friday) Pre-programmed schedule. Please note: this schedule cannot be adjusted.

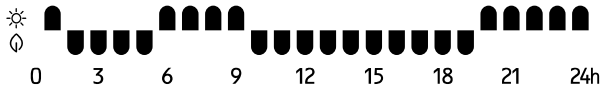

- 00:00am – 01:00am comfort mode,
- 01:00am – 05:00am ECO mode
- 05:00am – 09:00am comfort mode,
- 09:00am – 19:00pm ECO mode
- 19:00pm – 00:00am comfort mode

**P2** (Saturday-Sunday) Pre-programmed schedule. Please note: this schedule cannot be adjusted.

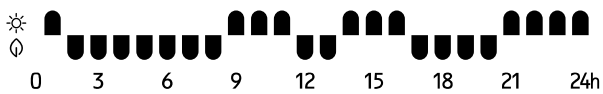

- 00:00am – 01:00am comfort mode,
- 01:00am – 08:00am ECO mode
- 08:00am – 11:00am comfort mode,
- 11:00am – 13:00pm ECO mode
- 13:00pm – 16:00pm comfort mode,
- 16:00pm – 20:00pm ECO mode
- 20:00pm – 00:00am comfort mode.

**P3** (Monday-Friday) Programmable schedule. Please note that this schedule can be adjusted to suit your requirements using the instructions below. The below is for illustration purposes only.

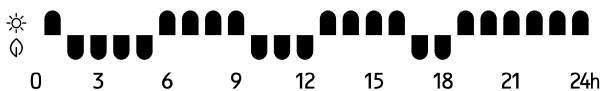

- 00:00am – 01:00am comfort mode,
- 01:00am – 05:00am ECO mode
- 05:00am – 09:00am comfort mode,
- 09:00am – 12:00pm ECO mode
- 12:00pm – 16:00pm comfort mode,
- 16:00pm – 18:00pm ECO mode
- 18:00pm – 00:00am comfort mode.

**P3** (Saturday-Sunday) Programmable schedule. Please note that this schedule can be adjusted to suit your requirements using the instructions below. The below is for illustration purposes only.

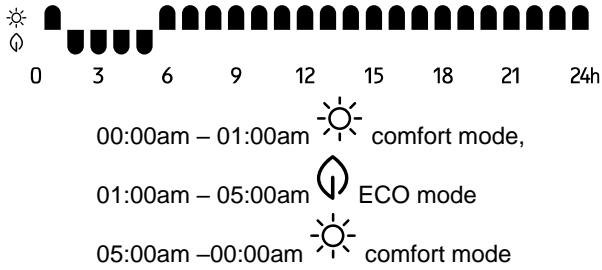

### **P3 Adjustable program setting**

1. Press mode and select P3. press for 3 secs to enter day setting:
2. The screen will display . Press and to set from (Monday-Sunday).

1	Monday
2	Tuesday
3	Wednesday
4	Thursday
5	Friday
6	Saturday
7	Sunday

Press to confirm and enter hour setting:

3. The screen will display . Press and to select the hour from 00-24. Press to choose heating mode for every hour. Comfort mode or ECO mode .
4. Repeat the operation until you have completed the schedule of every hour and every day.

Notes: After setting heating mode for hour 23, press to come back to day setting.

When screen displays , press to set scheduling.

### **And BUTTONS**

Use these buttons to increase or decrease the target temperature, and to increase or decrease time within timer function

This feature can be performed using the TCP Smart App.



### **TIMER BUTTON**

**24 Hr Timer** Press once, the screen will display "" and will keep flashing. Press and to set timer from 0-24 hours. Wait 3 seconds to confirm setting. From the moment the time is set, the timer will then continue to count down. During the countdown, when the target temperature is reached, the towel heater will turn off. Once the heater detects a fall in actual room temperature it will restart. Once the countdown is ended the heater will turn off completely.

**Pre-Set Quick Timer** Press one time, the screen will display "", press once to select the desired time either 2Hrs, 4Hrs, 6Hrs or 8Hrs. From the moment the time is set, the timer will then continue to count down. During the countdown, when the target temperature is reached, the towel heater will turn off. Once the heater detects a fall in actual room temperature it will restart. Once the countdown is ended the heater will turn off completely.









This feature can be performed using the TCP Smart App.

### Clock and day of the week setting

Press the  button for 3 seconds. The screen display will show "□". Press  and  to select the day:

The number displayed will correspond to the day of the week as below:

1	Monday
2	Tuesday
3	Wednesday
4	Thursday
5	Friday
6	Saturday
7	Sunday

Press  to confirm the day and enter the clock hour setting. The screen will display . Press  and  to set the HOUR time. Press  to confirm the time set and enter minute setting with the screen displaying . Press  and  to set the MINUTE time.

### **OPEN WINDOW FUNCTION**

When the ambient temperature drops by 5°C within 10 minutes, the heater will register the possibility of an open window in the room. If this happens, it will stop heating and enter standby mode.

To turn on open window function, press Mode and + buttons together and the screen will display  , after 3 seconds, the screen will display the set temperature.

To turn off open window function, press Mode and - buttons together and the screen will display  , after 3 seconds, the screen will display the set temperature.

### **CLEANING THE HEATER**

Allow heater to cool down before cleaning. Clean the outside of the heater by wiping with a damp cloth and buff with a dry cloth. Do not use anydetergents or abrasives.

### **CORRECT DISPOSAL OF THIS PRODUCT**



### **WARRANTY INFORMATION**

The manufacturer provides warranty in accordance with the legislation of the customer's own country of residence, with a minimum of 2 year, starting from the date on which the appliance is sold to the end user.

The warranty only covers defects in material or workmanship.

The repairs under warranty may only be carried out by an authorized service centre. When making a claim under the warranty, the original bill of purchase (with purchase date) must be submitted. The warranty will not apply in cases of:

- Normal wear and tear
- Incorrect use, e.g. overloading of the appliance, use of non-approved accessories
- Use of force, damage caused by external influences

- Damage caused by non-observance of the user manual, e.g. connection to an unsuitable mains supply or non-compliance with the installation instructions
- Partially or completely dismantled appliances.

### **CERTIFICATION CONFORMITY**

Hereby, Technical Consumer Products Ltd declares that the radio equipment type TCP Smart Wifi Tower Fan 2000W – White is in accordance with Directive 2014/53/EU.

The full text of the EU declaration of conformity is available at the following internet address – <https://tcpSMART.eu/compliance-data>

### **REGISTERED OFFICES**

TCP UK Ltd, 1 Exchange Court, Cottingham Road, Corby, Northants, NN17 1TY.

TCP France, Quai Gabriel P'ri, 1, Joinville Le Point, France, 94340.



## CONNECTING THE APPLIANCE TO WI-FI

Use the QR code below to download the TCP Smart App for control of the heater by voice or TCPSmart App.



QR code for both android and iOS

To control the heater using the TCP Smart App the unit must be turned on. Before you get started you will need the following:

- Smart device such as a mobile phone
- Access to the Google or Apple App store, log on and passwords
- The name of your Wi-Fi network and password to your Wi-Fi network
- Confirm your home Wi-Fi router is running on 2.4Ghz and not 5Ghz. If you are unsure, please consult your broadband provider for details on how to change the settings.
- Turn off any Wi-Fi extenders during set up
- Check you do not have any limitations on the number of devices with your broadband provider

Please note: Our products do not work on 5Ghz only 2.4Ghz.

**For instructions on how to connect to Amazon Alexa or Google Nest please visit <https://www.tcpsmart.eu/how-to-alexa-google-nest>**

With the heater turned on, hold down the Mode button  for 3 seconds until it bleeps and the WiFi LED light blinks rapidly, the device is now in pairing mode. In the TCP Smart App, enter your WiFi password and follow the instructions in the App to connect.

# USING THE APPLIANCE WHEN CONNECTED TO WIFI

## Main screen showing functions

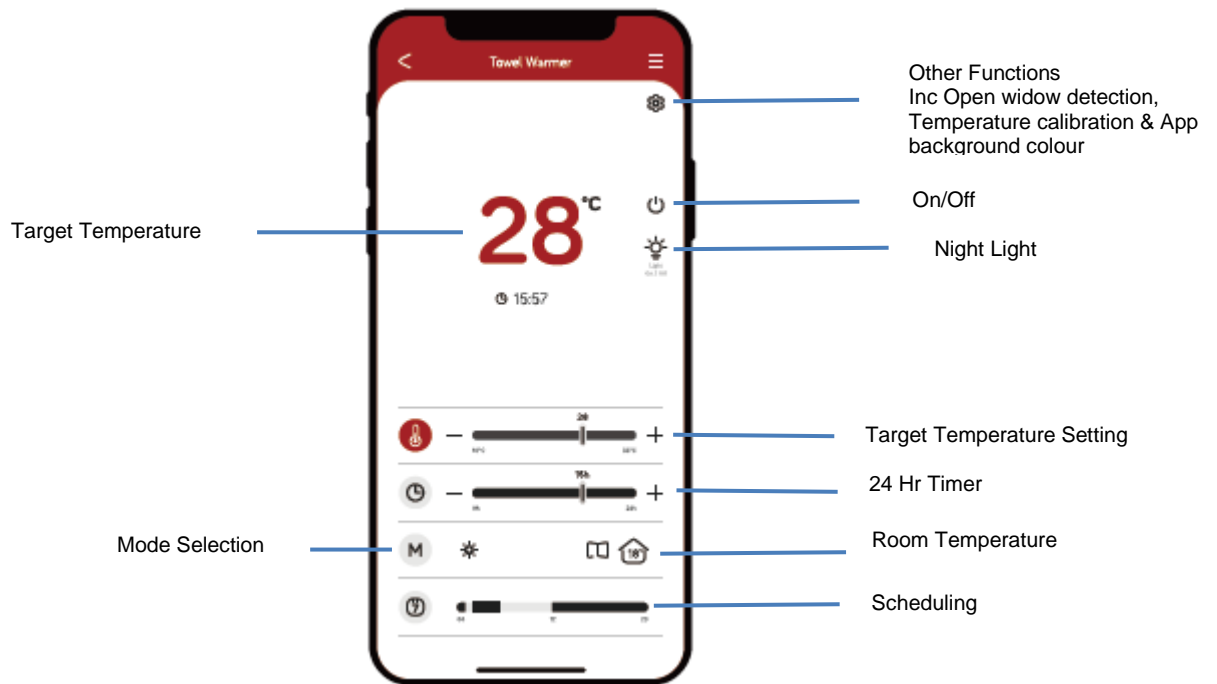

## Mode Selection Screen

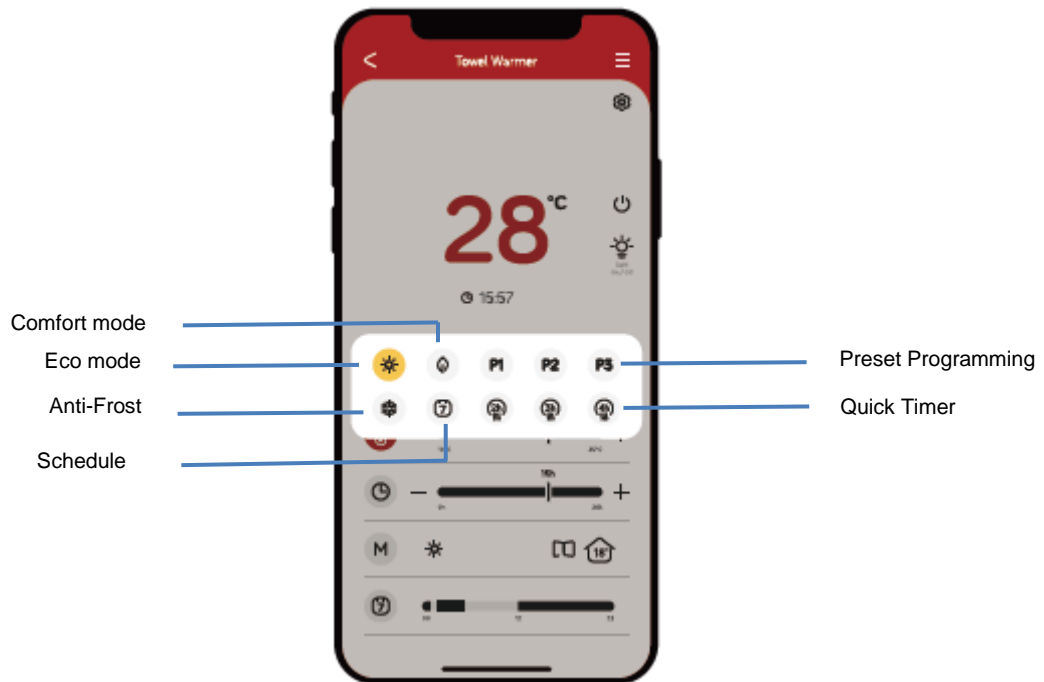



## Other functions

Select for following functions: Open Window Detection, Temperature Calibration and LCD Background colour.



## Open window Detection

Press  on main screen. Slide  Open Window button to left to turn on. Slide to right to turn off. Press < to return to main screen

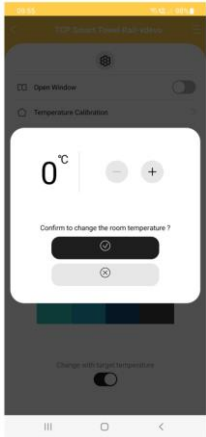

## Temperature Calibration

Use this function to manually adjust to the actual room temperature if it is not correct.



Use this function to manually adjust to the actual room temperature if it is not correct.



Press  on main screen.

Change the temperature by using  or  buttons.

Once you have set the temperature press tick button to set and < to return to previous screen.

Current room temperature is displayed on the main screen. 

## App background colour

Press other functions button . To turn on slide the button  to change with target temperature to the right. To turn off this function slide this button to the left. Press < to return to main screen.

## Night Light



Press **Light On / Off** to dim the LCD screen. Press again to return to normal brightness.

## Target Temperature Setting



Use + and – buttons to set target temperature.

## Timer



Use the + and – button to set a countdown, from 1 to 23 hours. From the moment the time is set, the timer will then continue to count down. During the countdown, when the target temperature is reached, the towel heater will turn off. Once the heater detects a fall in actual room temperature it will restart. Once the countdown is ended the heater will turn off completely.

For pre-set quick timer function see mode settings below.

## Smart Scheduling



Press timer bar to take you to the below screen:

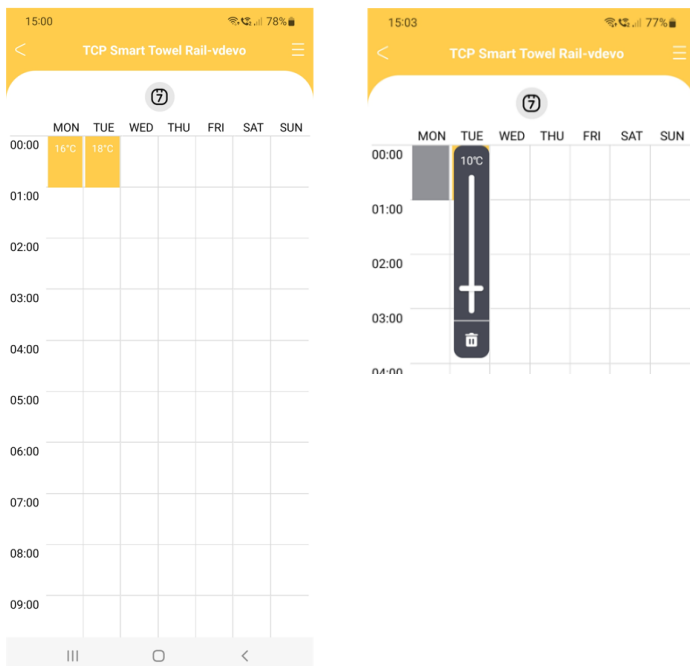

The scheduling can be selected as hourly increments on separate days. When you press the hour in any given day a temperature bar will be displayed.

Use this to select the temperature for that hour. Repeat as needed across each day / each hour of the day. Press < to return to main screen.

Note: Press Mode and  to activate scheduling.

M

## **Mode**

Select  to choose the following functions:

**Comfort mode**  - Set using the temperature scale on the main screen. Press < to return to main screen.

**Eco mode**  – this is a preset temperature which is 4°C below the comfort mode setting. Press < to return to main screen.

**P1** Present Programme – see below



**P2** Present Programme – see below

**P3** Adjustable Programme – see below

P1 and P2 are pre-programmed schedules. P3 is a schedule that can be set to your own requirements. This is done via the LCD screen on the heater using the steps below. Each programme can then be activated by pressing the corresponding P1, P2 or P3 symbol. Press  to turn off. Press < to return to main screen.





## **Anti Frost**

For this function to work the heater must be turned on. Once the Anti-frost mode is selected the target temperature will be overridden and the heater will stay at 7°C until the anti-frost function is turned off. . Select  to turn this function on. Press  to turn off. Press < to return to main screen.

## **Scheduling**



Press  to turn on the scheduling you have selected. Press  to turn off. Press < to return to main screen.

## **Quick Timer**



Select 2h, 3h or 4h for the heater to go into a countdown timer. From the moment the timer is set, the heater will continue to count down. Once completed the Towel Radiator will switch off.

**Once the target temperature is reached the towel heater will stay on until the countdown time is finished.**

Press  to turn off ahead of the countdown time finishing. Press < to return to main screen.