

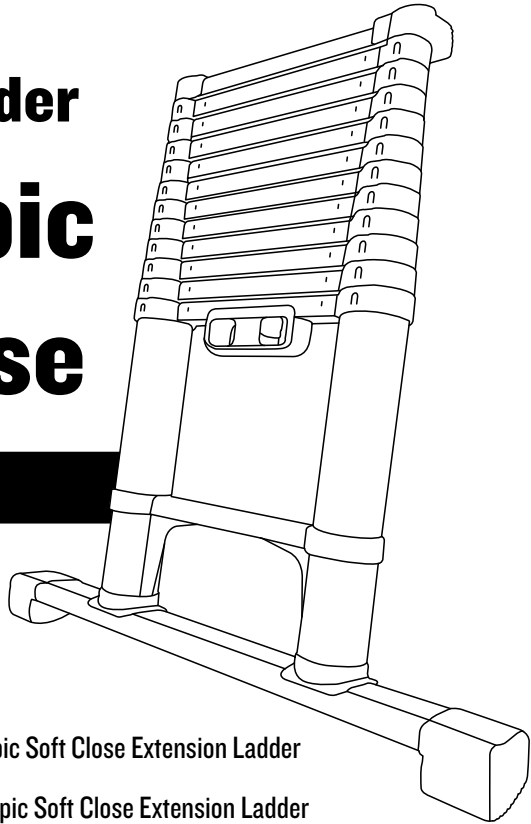

Extension Ladder Telescopic Soft Close

Instruction Manual



For models:

Product Code	Product Description
85026	2.6m, 9 Rungs Telescopic Soft Close Extension Ladder
85029	2.9m, 10 Rungs Telescopic Soft Close Extension Ladder
85032	3.2m, 11 Rungs Telescopic Soft Close Extension Ladder with Stabiliser
85038	3.8m, 13 Rungs Telescopic Soft Close Extension Ladder with Stabiliser

CONTENTS

Leaning Ladder Guide	3
Product Identified	6
Stabiliser Assembly (For 3.2m and 3.8m models only)	7
Operating Guide.	8
Ladder Safety Check	10
Guarantee.	11

LEANING LADDER GUIDE



IMPORTANT - Every month, more than a thousand people need hospital treatment because of accidents at home involving ladders... ABOVE ALL BE CAREFUL

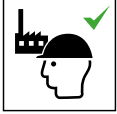

EN131

Ladder suitable for Professional Use



WARNING!

Fall from the ladder

BEFORE USE

- Read all instructions on and accompanying the ladder.



- Inspect the ladder after delivery. Before every use visually check the ladder is not damaged and is safe to use.

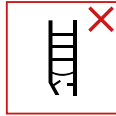

- Do not use a damaged ladder.

- Do not use the ladder if you are not fit enough. Certain medical conditions or medication, alcohol or drug abuse could make ladder use unsafe.



- Ensure the ladder is suitable for the task.

- Visually check the ladder is not damaged and is safe to use at the start of each day when the ladder is to be used.

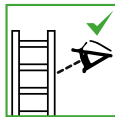

- Inspect ladder feet.



- For ladders that require a stabiliser do not use the ladder until the stabiliser bar has firstly been fully attached and secured to the ladder.

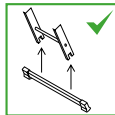

- Do not use the ladder if contaminated, e.g. with wet paint, mud, oil, water or snow.
- Prevent damage of the ladder when transporting e.g. by fastening and ensure they are suitably placed to prevent damage.
- For professional users regular periodic inspection is required.
- For professional use, a risk assessment shall be carried out respecting the legislation in the country of use.
- Do not modify the ladder design.

POSITIONING & ERECTING THE LADDER

- When positioning the ladder, take into account risk of collision with the ladder e.g. from pedestrians, vehicles or doors. Secure doors (not fire exits) and windows where possible in the work area.

- Warning! Electricity hazard. Identify any electrical risks in the work area, such as overhead lines or other exposed electrical equipment and do not use the ladder where electrical risks occur.



LEANING LADDER GUIDE

- Do not erect ladder on contaminated ground. Ladders shall not be positioned on slippery surfaces (such as ice, shiny surfaces or significantly contaminated solid surfaces) unless additional effective measures are taken to prevent the ladder slipping or ensuring contaminated surfaces are sufficiently clean.

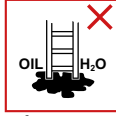

- Do not use the ladder on an unlevel or unfirm base.



- Ladder shall be on an even, level and unmovable base.

- Do not lean the ladder against unsuitable surfaces. Leaning ladder should lean against a flat non-fragile surface and should be secured before use e.g. tied or use of a suitable stability device.



- Only use the ladder in the direction as indicated.



- Ladder shall be erected at the correct position, such as the correct angle for a leaning ladder (angle of inclination approximately 1:4) with the rungs or treads level.



- All locking mechanisms for all extended rungs/steps shall be checked and be locked before use.



- Ladder should be stood on its feet, not the rungs or steps.

- Leaning ladders with steps, shall be used that the steps are in a horizontal position.
- Secure ladder at the top and bottom wherever possible. If not, station someone at the foot of the ladder.
- Do not move a ladder while standing on it.
- Ladder shall never be repositioned from above.

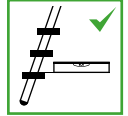

USING THE LADDER

- Do not exceed the maximum total load (load includes users, tools, materials, etc.).



- Maximum number of users on the ladder.



- Do not wear unsuitable footwear when climbing a ladder.

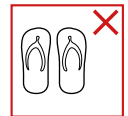

- Do not ascend or descend unless you are facing the ladder.



- Keep a secure grip on the ladder when ascending and descending. Maintain 3 points of contact whilst working from a ladder or take additional safety precautions if you cannot.



- Do not stand on the top four steps/rungs of a leaning ladder.



LEANING LADDER GUIDE

- Do not stand on the last metre of a telescopic ladder



- Do not overreach, user should keep their belt buckle (navel) inside the stiles and both feet on the same step/rung throughout the task.



- Avoid work that imposes a sideways load on ladders, such as side-on drilling through solid materials.



- Do not carry equipment which is heavy or difficult to handle whilst using a ladder.



- Equipment carried while using a ladder should be light and easy to handle.

- Leaning ladders used for access to a higher level shall be extended at least 1m above the landing point and secured if necessary.



- Use non-conductive ladders for unavoidable electrical work.
- Secure doors (not fire exits) and windows where possible in the work area.
- Do not use the ladder outside in adverse weather conditions, such as strong wind.
- When outdoors, be cautious in windy conditions.
- Ladders should only be used for light work of a short duration.
- Do not spend long periods on the ladder without regular breaks (tiredness is a risk).

- Do not use the ladder as a bridge.



- Do not bring your hands/fingers in rung area (area of shearing) when bringing the ladder in to its possible position of use.



- Take precautions against children playing on the ladder.

PRODUCT IDENTIFIED

2.6m & 2.9m models

- 1** Support Ring
- 2** Rung
- 3** Lock Indicator
- 4** Lock Release
- 5** Wall Bumper
- 6** Bottom Rung

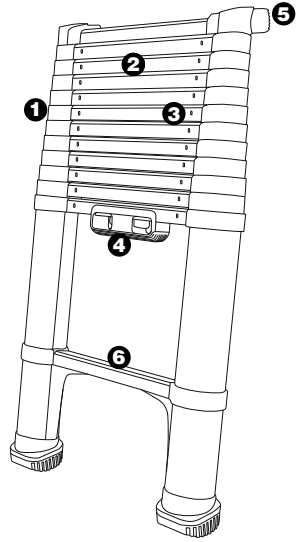

3.2m & 3.8m models

- 1** Support Ring
- 2** Rung
- 3** Lock Indicator
- 4** Lock Release
- 5** Wall Bumper
- 6** Bottom Rung
- 7** Stabiliser Bar
- 8** Push-on End Caps

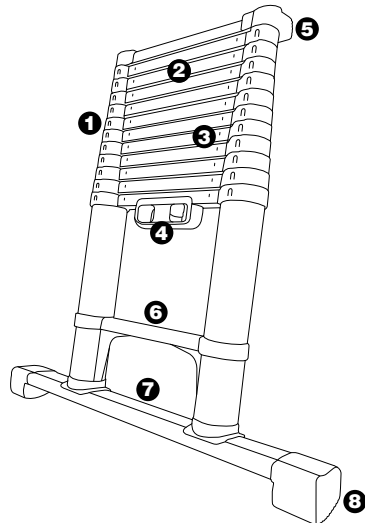

STABILISER ASSEMBLY



For the 3.2m or 3.8m model that is supplied with a stabiliser bar - **DO NOT** use the ladder until the stabiliser bar has firstly been fully assembled and secured to the ladder.

1. CONTENTS

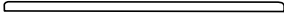

A Stabiliser Bar x 1



B Push-on End Caps x 2



C M8x25 Screws x 2



D Ø3x15 Self-tapping Screws x 2

2. TOOLS REQUIRED



PH2

3. ASSEMBLY INSTRUCTIONS

1

Fasten the two push-on end caps (B) to the stabiliser bar (A) using the supplied self-tapping screws (D).

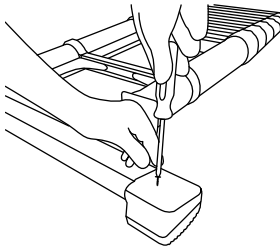

2

Ensure that the locking pin snaps in place through the hole in the aluminium profile (C).

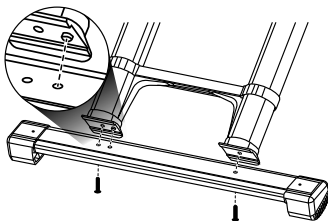

3

Firmly tighten the two screws (C).

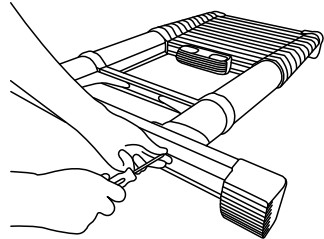

4

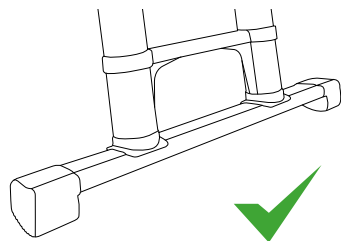

OPERATING GUIDE



IMPORTANT – Read all instructions carefully before setting up and using the ladder. The ladder should be inspected after delivery and before every use to confirm condition and operating of all parts.

1

Place the ladder with both feet on the ground such that you are facing the lock indicators and that you can see the buttons clearly. This is also the correct side to use when climbing the ladder.

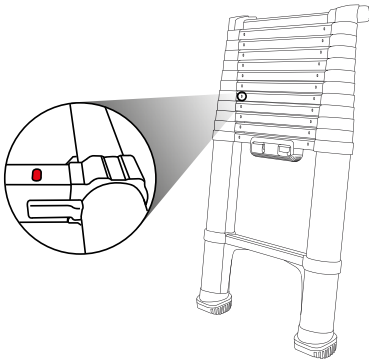

2

When extending the ladder, place one foot on the bottom rung to stabilise the ladder and pull upward the top two support rings until the section locks.

Repeat this procedure until the ladder is fully extended.

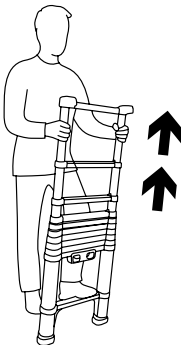

3

If you do not intend to use the entire length of the ladder, extend the ladder to the desired length leaving the rungs that have not been extended grouped at the top.

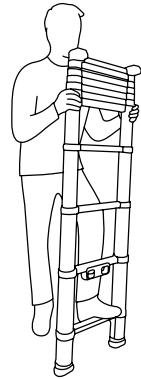
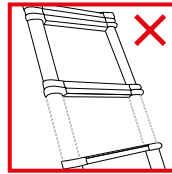
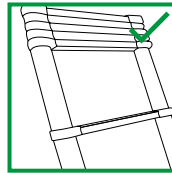

4

Check and ensure that all extended rungs are fully locked and that the lock indicators are showing full green.

Never attempt to use or climb the ladder if any of the lock indicators below each extended rung are showing full red.

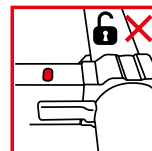
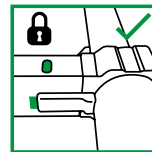

OPERATING GUIDE

5

Note the sloped shape of the ladder feet and location of the wall bumper square pads and then place the extended ladder forwards and at an angle of 75 degrees to the ground and supported at the top.

You can verify this by placing your feet in front of the ladder's feet and firmly holding the ladder.

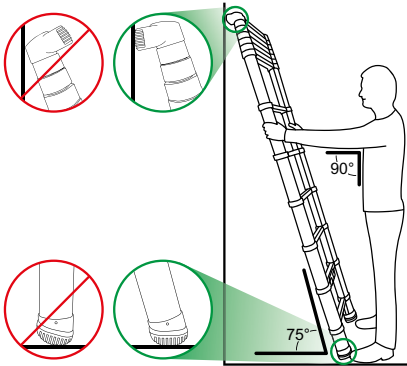

6

Never stand on the top four rungs and hold on to the stiles firmly for your own safety and comfort. When using the ladder in a partially extended state (with the unextended section on top), do not place your feet higher than the fifth rung from the top (the unextended section is considered the first rung).

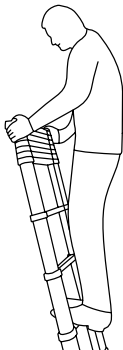

7

To close the ladder, support the ladder in an upright position with one hand and depress and then release both ladder lock release buttons with the other hand.

Place one foot on the bottom rung to stabilise the ladder and guide the rungs downwards with both hands.

Ensure that your hands are more than two rungs apart so that they do not get caught between rungs.

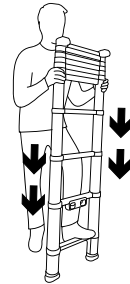
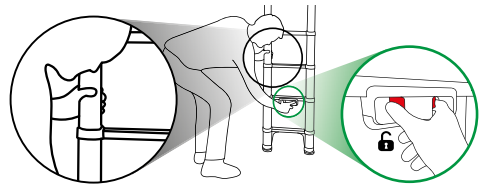

8

Transport the ladder fully closed and hand carry under arm with one hand hold the handle that is underside of the second rung.

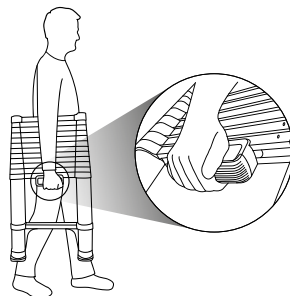

LADDER SAFETY CHECK



IMPORTANT – Professional users and equipment providers to professional users (e.g. employers) should engage in proper training such as the ladder association ladder inspection course. Please contact the customer helpline on 01621 745 900 for more information.

1. REPAIR, MAINTENANCE & STORAGE

- Repairs and maintenance shall be carried out by a competent person and be in accordance with the producer's instructions.
- Ladders should be stored in accordance with the producer's instructions.
- Replacement spare parts are available to order online at wernerco.com.

2. LIST OF ITEMS TO BE INSPECTED

For regular inspections, the following items shall be taken into account-

CHECK:

- ☑ The stiles/legs (uprights) are not bent, bowed, twisted, dented, cracked, corroded or rotten.
- ☑ The stiles/legs around the fixing points for other components are in good condition.
- ☑ The fixings (usually rivets, screws or bolts) are not missing, loose or corroded.
- ☑ The rungs/steps are not missing, loose, excessively worn, corroded or damaged.
- ☑ The hinges between the front and rear sections are not damaged, loose or corroded.
- ☑ The locking stays horizontal, back rails and corner braces are not missing, bent, loose, corroded or damaged.
- ☑ The rung hooks are not missing, damaged, loose or corroded and engage properly on the rungs.
- ☑ The guide brackets are not missing, damaged, loose or corroded and engage properly on the mating stile.
- ☑ The ladder feet/end caps are not missing, loose, excessively worn, corroded or damaged.
- ☑ The entire ladder is free from contaminants (e.g. dirt, mud, paint, oil or grease).
- ☑ The rung locking catches are not damaged, sticking or jammed and are functioning correctly.

If any of the above checks cannot be fully satisfied, you should **NOT** use the ladder.

LADDER SAFETY CHECK

3. STORAGE

The important considerations when storing a ladder (not in use) should include the following:

- ☑ Is the ladder stored away from areas where it's condition could deteriorate more rapidly e.g. dampness, excessive heat, or exposed to the elements?
- ☑ Is the ladder stored in a position which helps it remain straight e.g. hung by the stiles on proper ladder brackets or laid on a flat clutter free surface?
- ☑ Is the ladder stored where it cannot be damaged by vehicles, heavy objects, or contaminants?
- ☑ Is the ladder stored where it cannot cause a trip hazard or an obstruction?
- ☑ Is the ladder stored securely where it cannot be easily used for criminal purposes?
- ☑ If the ladder is permanently positioned (e.g. on scaffolding), is it secured against unauthorised climbing (e.g. by children)?

GUARANTEE

Guarantee includes faults arising from defects in workmanship or materials except for -

- Ordinary wear and tear of the product.
- Damage caused by misuse or abuse of the product.
- Damage caused by failure to comply with all written warnings and instructions for the product.
- Damage caused by an attempted repair of the product.

Material - means a material or component used by Werner UK Sales & Distribution Ltd. in the manufacture of the product.

Workmanship - means the handling, assembly and manufacturing processes performed by or on behalf of Werner UK Sales & Distribution Ltd. in order to manufacture the product.



Werner UK Sales & Distribution Ltd.

Blackwater Trading Estate, The Causeway, Maldon, Essex, CM9 4LJ
WernerCo Hungary. Kft. 6000 Kecskemét, Szt. Istvan Krt. 19 Hungary

☎ +44 (0)1621 745900 ✉ uk.customercare@wernerco.com 🌐 wernerco.co.uk