

PHILIPS

hue personal
wireless
lighting

Adore



HUE serial number



User manual
Benutzerhandbuch
Notice d'emploi
Manual de usuario
Manual do usuário
Manuale d'uso

Incl.



Excl.

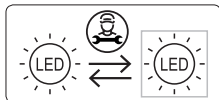
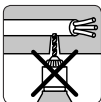
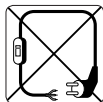
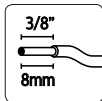
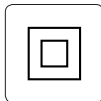
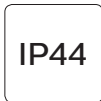
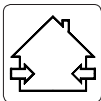
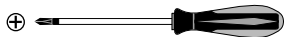
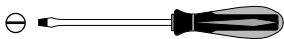
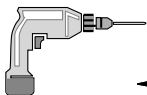

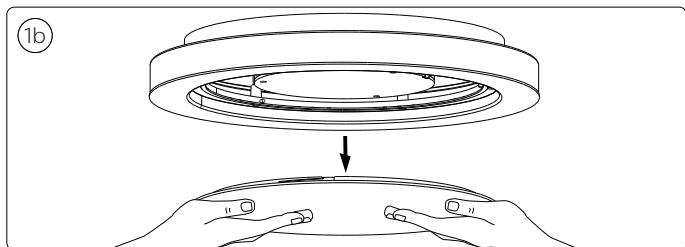
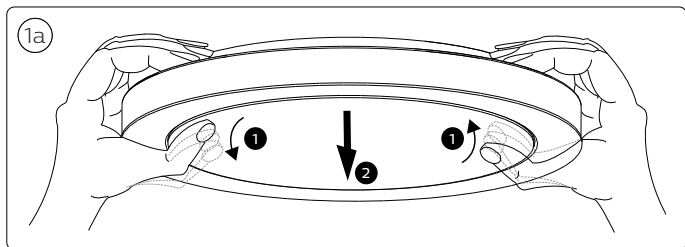
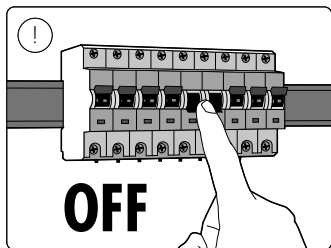

2

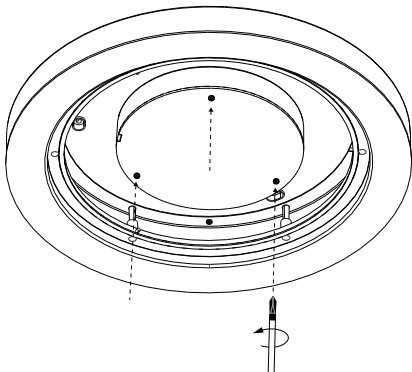

3

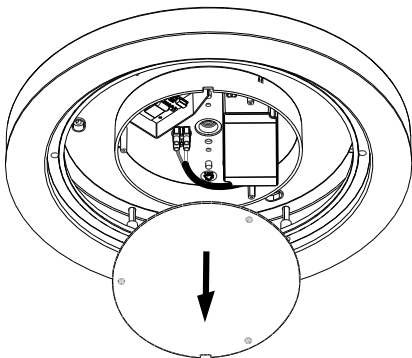

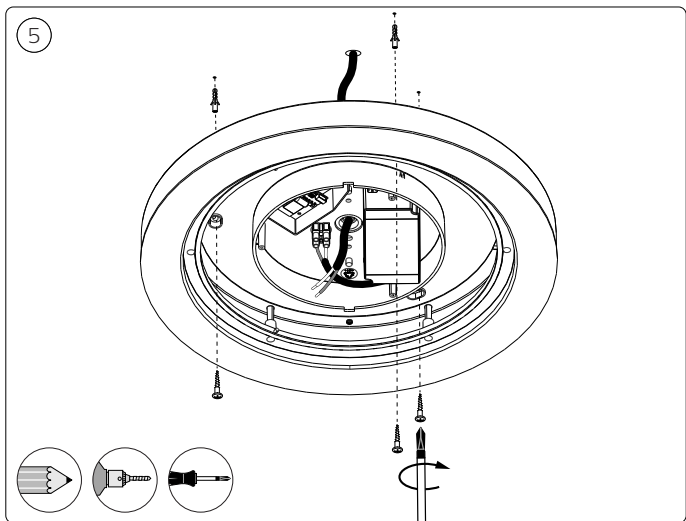
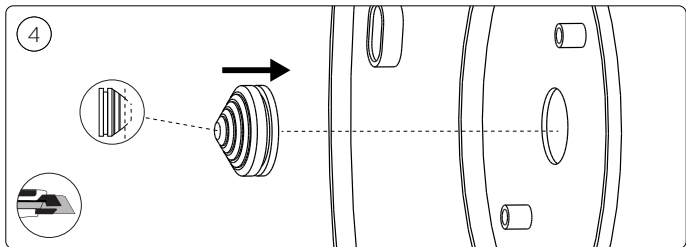

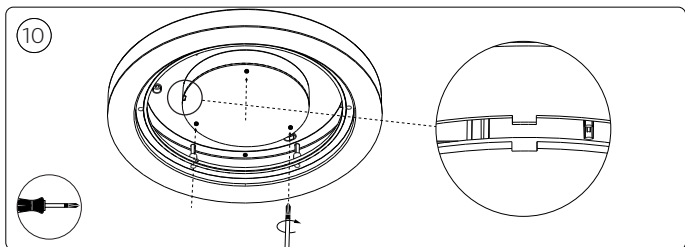
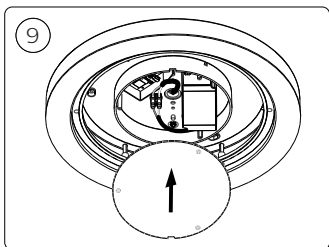
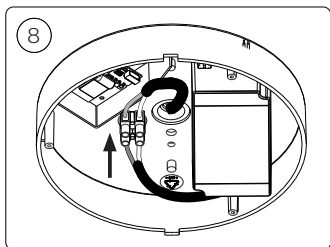
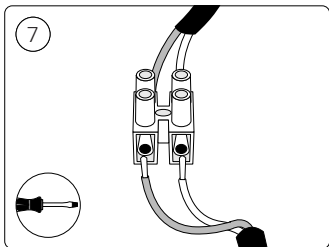
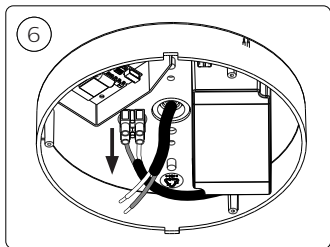

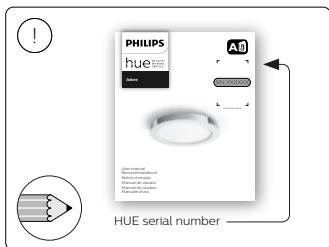
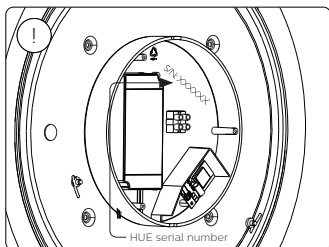
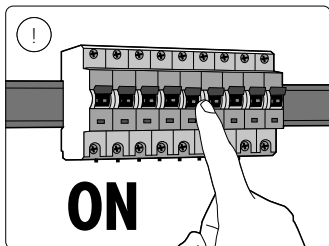
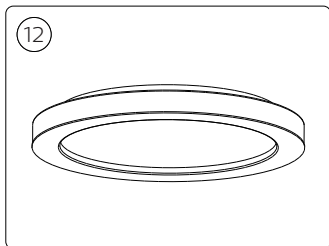
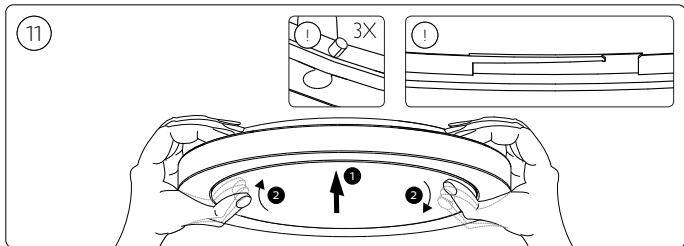

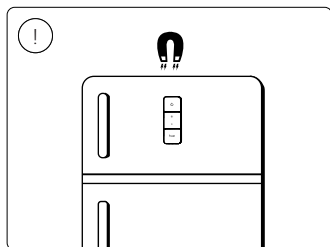
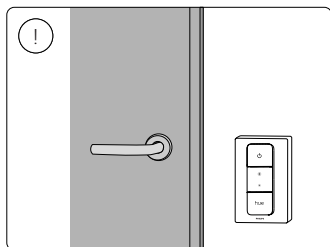
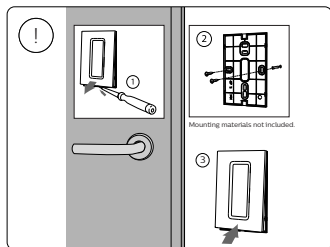
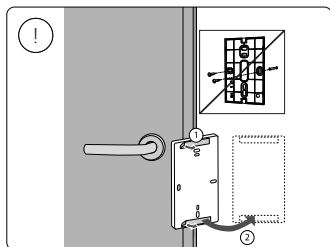
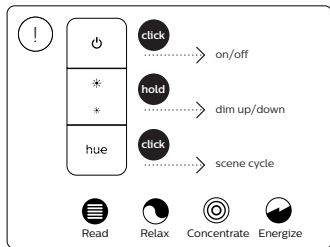
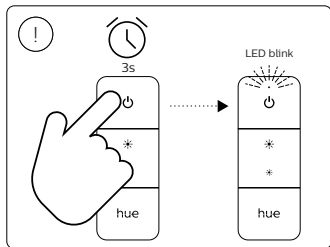

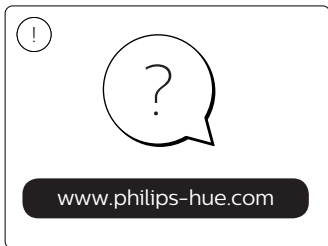
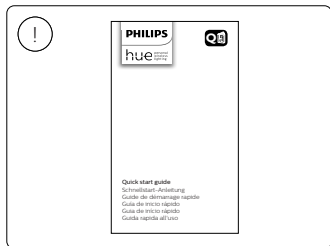



Signify
I.B.R.S. / C.C.R.I. Numéro 10461
5600 VB Eindhoven,
the Netherlands
☎00800-74454775

Signify Australia Limited
65 Epping Road, North Ryde,
NSW, 2113 Australia
Toll Free number: 1300 304 404

Signify New Zealand Limited
123 Carlton Gore Road
Newmarket, Auckland 1023
New Zealand
Tel: 0800 454 448

© 2021 Signify Holding
All rights reserved

www.philips-hue.com

4404 029 09175
Last update: 09/2021