

STEP 1

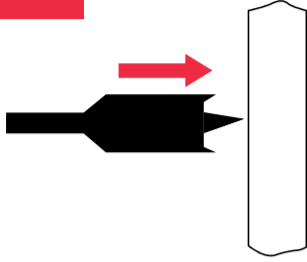

- We recommend using a cable finder to detect any existing cables behind the plasterboard
- Mark out the hole centre with a pencil or marking tool
- Using a 20mm diameter spade bit, drill a hole

IMPORTANT: Only apply a gentle pressure whilst drilling to avoid damaging the rear of the plasterboard.

Bullfix Universal fixings are designed to be used with standard (12.5mm to 16mm) thickness plasterboard attached to stud walls, dot & dab and insulation backed plasterboard. To operate properly they require a minimum cavity depth of 7mm (with shallower cavities the fin tails will not be able to open properly).

STEP 2

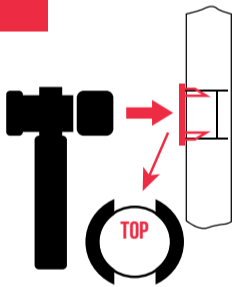

- Insert the collar and gently tap with a mallet

STEP 3

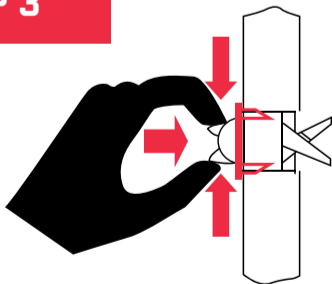

- Push the closed fixing gently through the collar with the fin tails aligned vertically
- Pinch the projected fin tails together

STEP 4

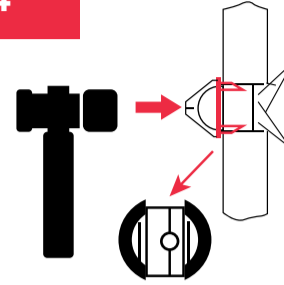

- Tap the rear of the fixing until the two halves of the fixing hole align to accept a screw.

IMPORTANT: If the plasterboard is more than 12.5mm thick the fixing may slide into the collar, this is normal. You may also need to tap a little harder the thicker the plasterboard.

STEP 5

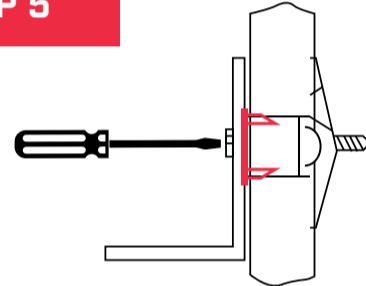

- Attach the object to the wall using the screws provided or any standard 5mm (No 10) screws
- To maximise performance, the screw should be long enough to reach the back of the fixing. If not, a longer screw should be used.
- To achieve the very maximum load capacity in plasterboard which is more than 12.5mm thick, we recommend using washers to fill the gap between the front faces of the fixing and the plasterboard.

IMPORTANT: We do not recommend using screws that travel more than 20mm past the front surface unless you know the cavity is deeper.

**SCAN HERE FOR AN
INSTRUCTIONAL VIDEO:**



Maximum load strengths are dependent on plasterboard thickness, humidity and brand. Please refer to the datasheet on www.bullfix.co.uk for more information.

WE DO NOT RECOMMEND USING BULLFIX FOR TV MOUNTS WITH A CANTILEVER OR EXTENDABLE ARM AS WE CANNOT GUARANTEE THE RELIABILITY. IDEAL FOR USE WITH A FIXED OR TILTING TV BRACKETS.

	Bullfix Extra Fixing	Bullfix Universal Fixing
		
Maximum recommended Tension Load (15mm Plasterboard)	60 Kg	49 Kg
Maximum recommended Tension Load (12.5mm Plasterboard)	46 Kg	37 Kg
Maximum recommended Shear Load (15mm Plasterboard)	133 Kg	116 Kg
Maximum recommended Shear Load (12.5mm Plasterboard)	98 Kg	103 Kg
Maximum recommended Cantilever Load @ 150mm (15mm Plasterboard)	45 Kg	34 Kg
Maximum recommended Cantilever Load @ 150mm (12.5mm Plasterboard)	39 Kg	29 Kg
Minimum Cavity Required	20mm	7mm
Compatible Screws	5mm or No 10 thread	5mm or No 10 thread

1. Maximum recommended loads apply to plasterboard (British Gypsum Gyproc Wallboard) in a dry condition. Please note that variations in board mounting, moisture content, plasterboard brand or physical condition of board can adversely effect load bearing performance. Continuous and repetitive loading / unloading on the fixing will weaken plasterboard.
2. All recommended loads assume a minimum distance from the edge of the board of 50mm
3. When using multiple fixings, to maintain the best performance for the fixing we would recommend you keep a minimum center distance of 90mm between fixings.
4. For all maximum recommended loads required safety factors are considered.
5. Fixing Material - Glass Filled Nylon.

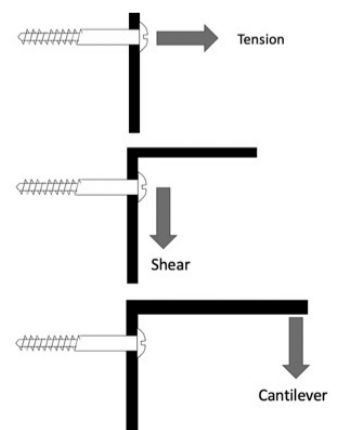

Rev B - Issue date 28/04/23

TV Mounting Brackets:

We do not recommend using Bullfix plasterboard fixings with TV mounting extendable arms. Any bracket that extends the center of gravity of any loading further than 150mm from the wall will risk exceeding the capability of the plasterboard fixing and in fact the plasterboard itself. We only recommend Bullfix plasterboard fixings for use with flat or tilting TV wall brackets.

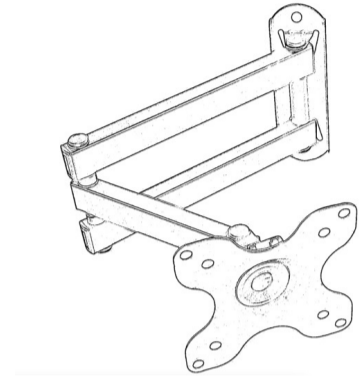
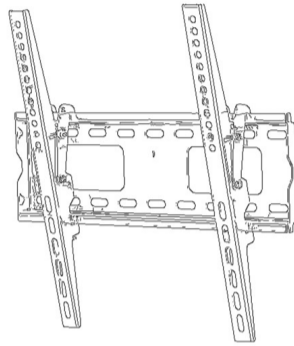
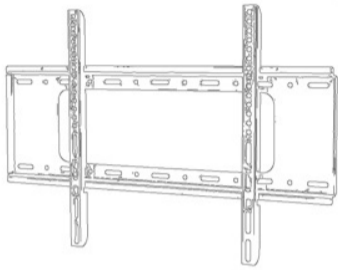

Radiator or Shelf Brackets:

We only recommend mounting items on plasterboard with Bullfix fixings using an appropriate bracket. The bracket should adhere to the specification shown below.

"Y" must be at least 1.5 times bigger than "X"

