

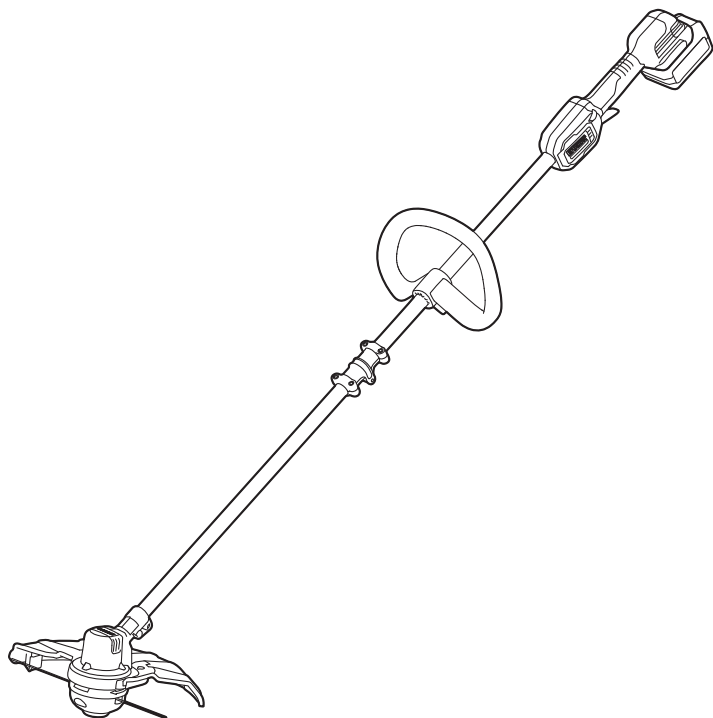

Erbauer



EGT18-Li

EAN. 5059340486581

EN ORIGINAL INSTRUCTIONS





Product description



Safety instructions



Assembly



Use



+



Care & maintenance



Guarantee



Declaration of Conformity



WARNING! Please read all safety warnings carefully and be sure that they are fully understood before handling the tool.



PRODUCT DESCRIPTION

1. Lock-Off Button
2. On/off switch trigger
3. Adjustable front handle
4. Hinge and coupler
5. Lower shaft
6. Safety Guard
7. Trimmer Line
8. Trimmer Head
9. Line-cutting Blade
10. Bump knob
11. Battery pack
12. Power bar button
13. Battery pack release button*
14. Main handle
15. Hex key



PRODUCT DESCRIPTION

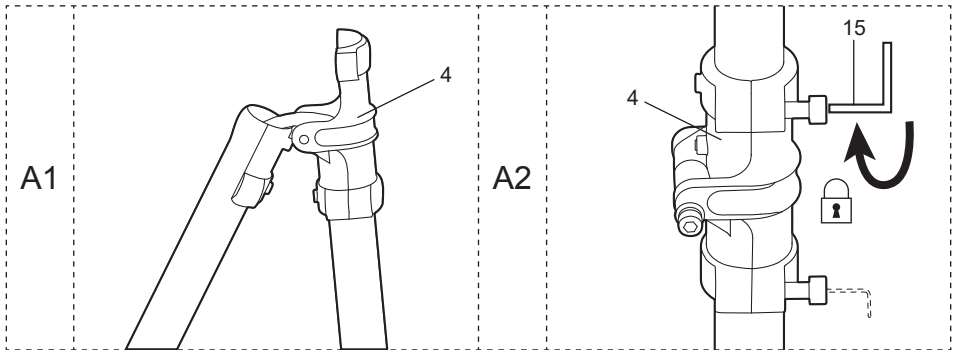
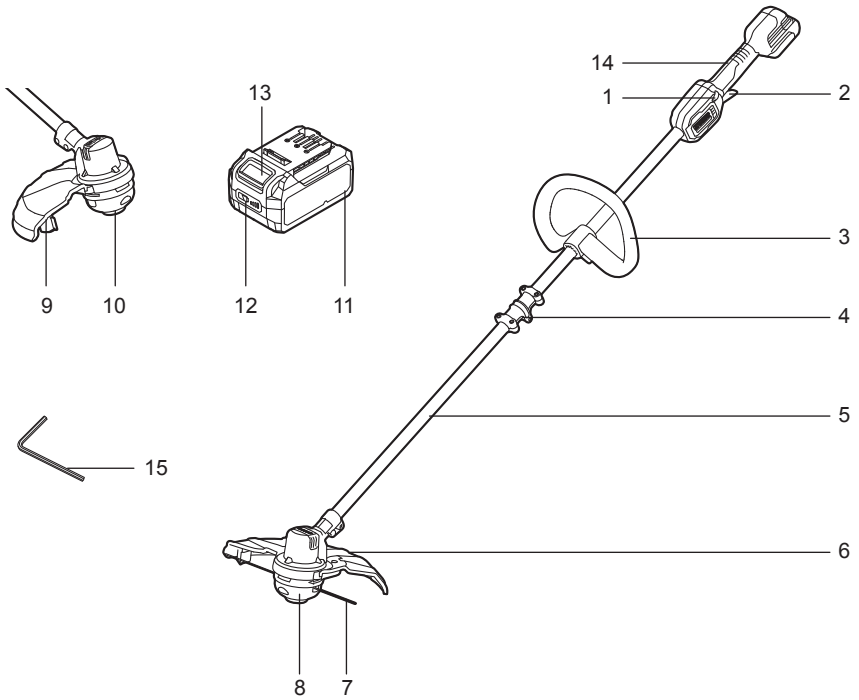

B

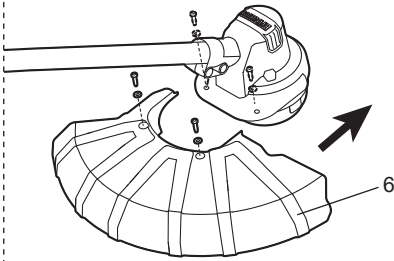

C

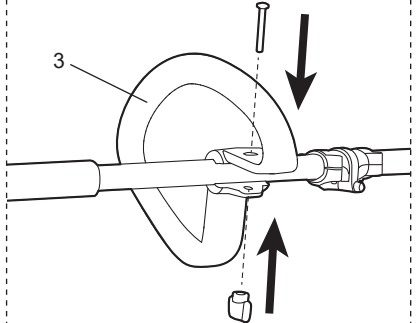

D1

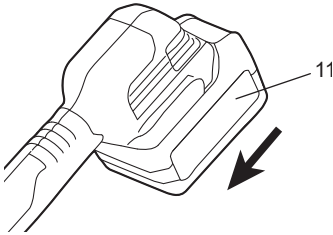

D2

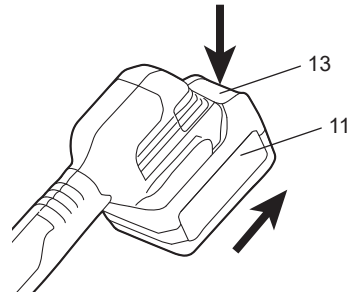

E



F

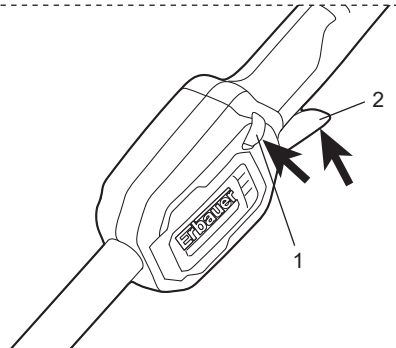

G

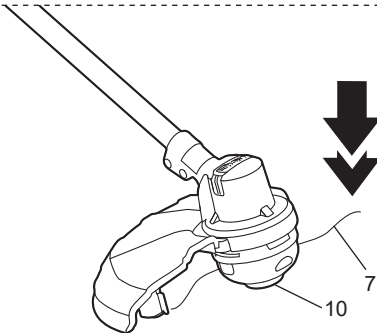

H

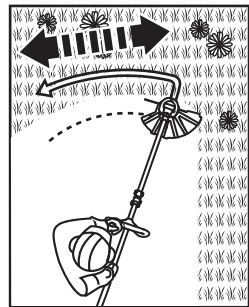

I1

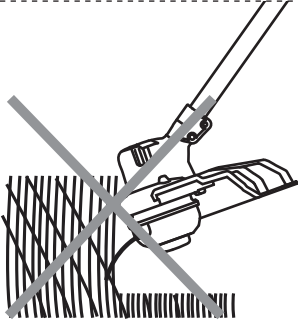

I2

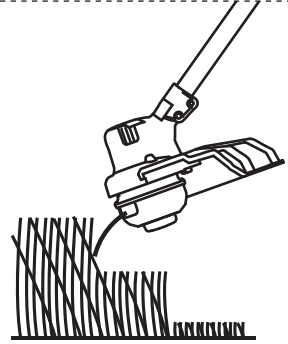

J

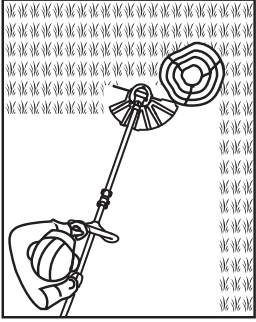

K

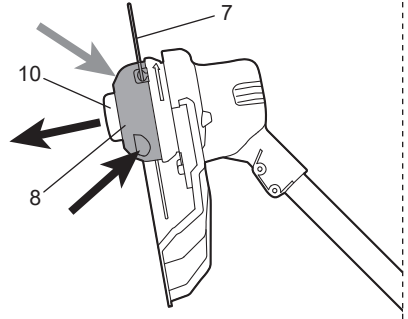

L

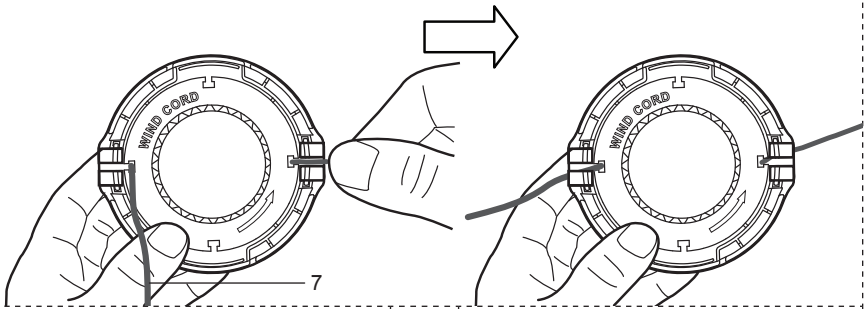

M

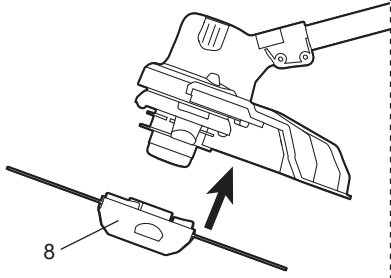

N1

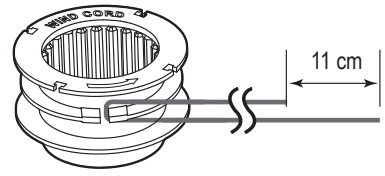

N2

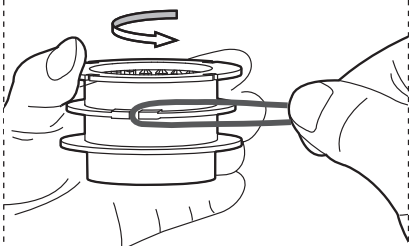

N3

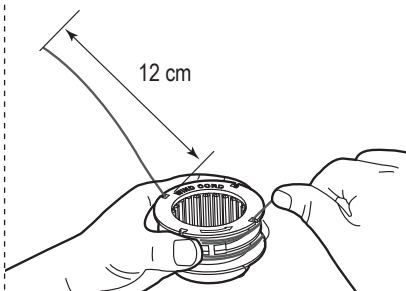

O

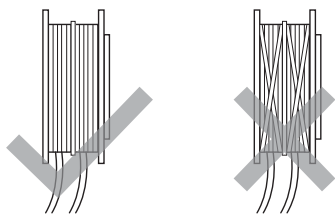



SAFETY INSTRUCTIONS

GENERAL POWER TOOL SAFETY WARNINGS



WARNING! Read all safety warnings, instructions, illustrations and specifications provided with this power tool. *Failure to follow all instructions listed below may result in electric shock, fire and/or serious injury.*

Save all warnings and instructions for future reference. *The term “power tool” in the warnings refers to your mains-operated (corded) power tool or battery operated (cordless) power tool.”*

WORK AREA SAFETY

- a. **Keep work area clean and well lit.** *Cluttered or dark areas invite accidents.*
- b. **Do not operate power tools in explosive atmospheres, such as in the presence of flammable liquids, gases or dust.** *Power tools create sparks which may ignite the dust or fumes.*
- c. **Keep children and bystanders away while operating a power tool.** *Distractions can cause you to lose control.*

ELECTRICAL SAFETY

- a. **Power tool plugs must match the outlet. Never modify the plug in any way. Do not use any adapter plugs with earthed (grounded) power tools.** *Unmodified plugs and matching outlets will reduce risk of electric shock.*
- b. **Avoid body contact with earthed or grounded surfaces, such as pipes, radiators, ranges and refrigerators.** *There is an increased risk of electric shock if your body is earthed or grounded.*

- c. **Do not expose power tools to rain or wet conditions.** *Water entering a power tool will increase the risk of electric shock.*
- d. **Do not abuse the cord. Never use the cord for carrying, pulling or unplugging the power tool. Keep cord away from heat, oil, sharp edges or moving parts.** *Damaged or entangled cords increase the risk of electric shock.*
- e. **When operating a power tool outdoors, use an extension cord suitable for outdoor use.** *Use of a cord suitable for outdoor use reduces the risk of electric shock.*
- f. **If operating a power tool in a damp location is unavoidable, use a residual current device (RCD) protected supply.** *Use of an RCD reduces the risk of electric shock.*

PERSONAL SAFETY

- a. **Stay alert, watch what you are doing and use common sense when operating a power tool. Do not use a power tool while you are tired or under the influence of drugs, alcohol or medication.** *A moment of inattention while operating power tools may result in serious personal injury.*
- b. **Use personal protective equipment. Always wear eye protection.** *Protective equipment such as a dust mask, non-skid safety shoes, hard hat, or hearing protection used for appropriate conditions will reduce personal injuries.*
- c. **Prevent unintentional starting. Ensure the switch is in the off- position before connecting to power source and/or battery pack, picking up or carrying the tool.** *Carrying power tools with your finger on the switch or energising power tools that have the switch on invites accidents.*
- d. **Remove any adjusting key or wrench before turning the power tool on.** *A wrench or a key left attached to a rotating part of the power tool may result in personal injury.*
- e. **Do not overreach. Keep proper footing and balance at all times.** *This enables better control of the power tool in unexpected situations.*

- f. **Dress properly. Do not wear loose clothing or jewellery. Keep your hair, clothing and gloves away from moving parts.** *Loose clothes, jewellery or longhair can be caught in moving parts.*
- g. **If devices are provided for the connection of dust extraction and collection facilities, ensure these are connected and properly used.** *Use of dust collection can reduce dust-related hazards.*
- h. **Do not let familiarity gained from frequent use of tools allow you to become complacent and ignore tool safety principles.** *A careless action can cause severe injury within a fraction of a second.*

POWER TOOL USE AND CARE

- a. **Do not force the power tool. Use the correct power tool for your application.** *The correct power tool will do the job better and safer at the rate for which it was designed.*
- b. **Do not use the power tool if the switch does not turn it on and off.** *Any power tool that cannot be controlled with the switch is dangerous and must be repaired.*
- c. **Disconnect the plug from the power source and/or the battery pack, if detachable, from the power tool before making any adjustments, changing accessories, or storing power tools.** *Such preventive safety measures reduce the risk of starting the power tool accidentally.*
- d. **Store idle power tools out of the reach of children and do not allow persons unfamiliar with the power tool or these instructions to operate the power tool.** *Power tools are dangerous in the hands of untrained users.*
- e. **Maintain power tools and accessories. Check for misalignment or binding of moving parts, breakage of parts and any other condition that may affect the power tool's operation. If damaged, have the power tool repaired before use.** *Many accidents are caused by poorly maintained power tools.*

- f. **Keep cutting tools sharp and clean.** *Properly maintained cutting tools with sharp cutting edges are less likely to bind and are easier to control.*
 - g. **Use the power tool, accessories and tool bits etc. in accordance with these instructions, taking into account the working conditions and the work to be performed.** *Use of the power tool for operations different from those intended could result in a hazardous situation.*
 - h. **Keep handles and grasping surfaces dry, clean and free from oil and grease.** *Slippery handles and grasping surfaces do not allow for safe handling and control of the tool in unexpected situations.*
- If the appliance is to be stored unused for a long period, the batteries should be removed;
 - The supply terminals are not to be short-circuited.

BATTERY TOOL USE AND CARE

- a. **Recharge only with the charger specified by the manufacturer.** *A charger that is suitable for one type of battery pack may create a risk of fire when used with another battery pack.*
- b. **Use power tools only with specifically designated battery packs.** *Use of any other battery packs may create a risk of injury and fire.*
- c. **When battery pack is not in use, keep it away from other metal objects, like paper clips, coins, keys, nails, screws or other small metal objects, that can make a connection from one terminal to another.** *Shorting the battery terminals together may cause burns or a fire.*
- d. **Under abusive conditions, liquid may be ejected from the battery; avoid contact. If contact accidentally occurs, flush with water. If liquid contacts eyes, additionally seek medical help.** *Liquid ejected from the battery may cause irritation or burns.*

- e. **Do not use battery pack or tool that is damaged or modified.** *Damaged or modified batteries may exhibit unpredictable behaviour resulting in fire, explosion or risk of injury.*
- f. **Do not expose a battery pack or tool to fire or excessive temperature.** *Exposure to fire or temperature above 130 °C may cause explosion.*
- g. **Follow all charging instructions and do not charge the battery pack or tool outside the temperature range specified in the instructions.** *Charging improperly or at temperatures outside the specified range may damage the battery and increase the risk of fire.*

SERVICE

- a. **Have your power tool serviced by a qualified repair person using only identical replacement parts.** *This will ensure that the safety of the power tool is maintained.*
- b. **Never service damaged battery packs.** *Service of battery packs should only be performed by the manufacturer or authorized service providers.*

ELECTRICALLY POWERED GRASS TRIMMER SAFETY WARNINGS

IMPORTANT

READ CAREFULLY BEFORE USE

KEEP FOR FUTURE REFERENCE



WARNING! When using the product the safety rules must be followed. For your own safety and that of bystanders please read these instructions before operating the product. Please keep the instructions safe for later use.

TRAINING

- a. *Read the instructions carefully. Be familiar with the controls and the proper use of the product.*

- b. Never allow children, persons with reduced physical, sensory or mental capabilities or lack of experience and knowledge or people unfamiliar with these instructions to use the machine, local regulations may restrict the age of the operator.*
- c. Keep in mind that the operator or user is responsible for accidents or hazards occurring to other people or their property.*

PREPARATION

- a. Never operate the product while people, especially children, or pets are nearby.*
- b. Wear eye protection and stout shoes and long trousers at all times while operating the product.*
- c. Before use, always visually inspect the machine for damaged, missing or misplaced guards or shields.*

OPERATION

- a. Avoid using the machine in bad weather conditions especially when there is a risk of lightning.*
- b. Use the product only in daylight or good artificial light.*
- c. Never operate the product with damaged guards or shields or without guards or shields in place.*
- d. Switch on the motor only when the hands and feet are away from the cutting means.*
- e. Before using the product and after any impact, check for signs of wear or damage and repair as necessary.*
- f. Always disconnect the product from the power supply (i. e. remove the plug from the power supply or the battery pack)*
 - whenever leaving the product unattended;*
 - before clearing a blockage;*
 - before checking, cleaning or working on the product;*
 - after striking a foreign object;*
 - whenever the product starts vibrating abnormally.*

- g. Take care against injury to feet and hands from the cutting device.*
- h. Always ensure that the air vents are kept clear of debris.*
- i. Take care against injury from any device fitted for trimming the filament line length, if applicable. After extending new cutter line always return the product to its normal operating position before switching on.*
- j. Never fit metal cutting elements.*
- k. Never use replacement parts or accessories not provided or recommended by the manufacturer.*
- l. Do not overreach and to keep the balance at all times, always be sure of the footing on slopes and to walk, never run.*
- m. Do not touch moving hazardous parts before the battery pack is removed and the moving hazardous parts have come to a complete stop.*

MAINTENANCE AND STORAGE

- a. Disconnect the product from the power supply (i.e. remove the plug from the power supply or the battery pack) before carrying out maintenance or cleaning work.*
- b. Use only the manufacturer's recommended replacement parts and accessories.*
- c. Inspect and maintain the product regularly. Have the product repaired only by an authorised service centre or similar qualified specialist.*
- d. When not in use, store the product out of the reach of children*

ADDITIONAL SAFETY WARNINGS FOR BATTERY

- a. Do not connect the positive terminal and negative terminal of the battery to each other with any metal object (such as wire).*
- b. Do not carry or store battery together with necklaces, hairpins or other metal objects.*
- c. Do not pierce the battery with nails, strike the battery with a*

hammer, step on the battery or otherwise subject it to strong impacts or shocks.

- d. Do not solder directly onto the battery.*
- e. Do not expose battery to water or salt water, or allow the battery to get wet.*
- f. Do not disassemble or modify the battery.*
- g. Do not place the battery in or near fire, on stoves or other high temperature locations. Do not place the battery in direct sunlight, or use or store the battery inside cars in hot weather.*
- h. Do not place the battery in microwave ovens, high-pressure containers or on induction cookware.*
- i. If you intend to store a battery for a period without use then store battery at room temperature (19°C to 25°C), charged to about 30 – 50% of capacity. When storing for very long periods boost charge the battery once per year to prevent over discharge.*

VIBRATION AND NOISE REDUCTION

To reduce the impact of noise and vibration emission, limit the time of operation, use low-vibration and low-noise operating modes as well as wear personal protective equipment.

Take the following points into account to minimize the vibration and noise exposure risks:

- a. Only use the product as intended by its design and these instructions.*
- b. Ensure that the product is in good condition and well maintained.*
- c. Use correct cutting attachments for the product and ensure they in good condition.*
- d. Keep tight grip on the handles/grip surface.*
- e. Maintain this product in accordance with these instructions and keep it well lubricated (where appropriate).*
- f. Plan your work schedule to spread any high vibration tool use across a longer period of time.*

EMERGENCY

Familiarise yourself with the use of this product by means of this instruction manual. Memorise the safety directions and follow them to the letter. This will help to prevent risks and hazards.

- a. *Always be alert when using this product, so that you can recognise and handle risks early. Fast intervention can prevent serious injury and damage to property.*
- b. *Switch off and disconnect from the power supply if there are malfunctions. Have the garden power tool checked by a qualified professional and repaired, if necessary, before you operate it again.*

RESIDUAL RISKS

Even if you are operating this product in accordance with all the safety requirements, potential risks of injury and damage remain. The following dangers can arise in connection with the structure and design of this product:

- a. *Health defects resulting from vibration emission if the product is being used over long periods of time or not adequately managed and properly maintained.*
- b. *Injuries and damage to property due to broken cutting attachments or the sudden impact of hidden objects during use.*
- c. *Danger of injury and property damage caused by flying objects.*



WARNING! This product produces an electromagnetic field during operation! This field may under some circumstances interfere with active or passive medical implants! To reduce the risk of serious or fatal injury, we recommend persons with medical implants to consult their doctor and the medical implant manufacturer before operating this product!



ASSEMBLY

01 UNPACKING

- Unpack all parts and lay them on a flat, stable surface.
- Remove all packing materials and shipping devices, if applicable.
- Make sure the delivery contents are complete and free of any damage. If you find that parts are missing or show damage do not use the product but contact your dealer. Using an incomplete or damaged product represents a hazard to people and property.
- Ensure that you have all the accessories and tools needed for assembly and operation. This also includes suitable personal protective equipment



WARNING! The product and the packaging are not children's toys! Children must not play with plastic bags, sheets and small parts! There is a danger of choking and suffocation!

02 ASSEMBLY



WARNING! The product must be fully assembled before operation! Do not use a product that is only partly assembled or assembled with damaged parts! Follow the assembly instructions step-by-step and use the pictures provided as a visual guide to easily assemble the product!

Do not attempt to modify this product or create accessories not recommended for use with this Line trimmer. Any such alteration or modification is misuse and could result in a hazardous condition leading to possible serious personal injury.

To prevent accidental starting that could cause serious personal injury, always remove the battery pack from the tool when assembling parts.

UNFOLDING THE SHAFT (FIG. A1, A2)



WARNING! In order to avoid pinching your hands or fingers, do not hold the shaft at the joints.



WARNING! Do not attempt to start the trimmer until the shaft has been locked.



WARNING! Always remove the battery pack from the product when you are assembling parts, making adjustments, cleaning, or when the product is not in use.

Put your trimmer on the ground and carefully unfold the lower shaft (5). Make sure that the cable is inside the shaft so that it will not be pinched when closing the joints (Fig. A1). Use the hex key provided to lock the shaft with the two short bolts (Fig. A2).

MOUNTING THE GUARD (FIG. B)



WARNING! Always wear gloves when mounting or replacing the guard. Be careful of the blade on the guard and protect your hands from being injured by the blade.



WARNING! Always remove the battery pack from the product when you are assembling parts, making adjustments, cleaning, or when the product is not in use.

Lift the trimmer head (8) and face it downward; slide the guard into the channels on the trimmer head ensuring that the mounting holes align. Make sure that the internal surface of the guard faces towards the trimmer head (Fig. B).

Lock the guard in place with the screws supplied.

MOUNTING AND ADJUSTING THE FRONT HANDLE (FIG. C)



WARNING! Always remove the battery pack from the product when you are assembling parts, making adjustments, cleaning, or when the product is not in use.

Push the front handle (3) onto the shaft, mount the lock bolt, and tighten it by using the wing nut (Fig. C). Adjust the front handle position to make sure your front arm is straight when using the trimmer before you fix the handle firmly.



NOTE: The front handle should be turned upwards to point toward the top of the handle.



WARNING! The tool cannot be used without the front handle reliably fixed.

CHARGING YOUR BATTERY PACK

The battery has been shipped in a low charge condition. Charge it fully before first use. Refer to the charger instruction manual for the details.







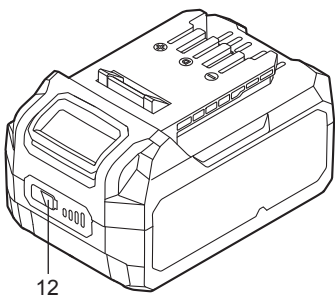

TO REMOVE OR INSTALL THE BATTERY PACK (D1, D2)

Depress the battery pack release button (13) to release and slide the battery pack (11) out from your tool.

After recharge, slide it back into your tool. A simple push and slight pressure will be sufficient.

BATTERY PACK POWER BAR

The Li-Ion battery pack (11) is equipped with a POWER BAR which is used to give an indication of the battery pack's remaining charge. Press the POWER BAR button (12) to check battery charge as below. The LED will stay lit for approximately 5 seconds.

  Flash  On  Off	76-100% Charge	
	51-75% Charge	
	26-50% Charge	
	5-25% Charge	
	under 5% Charge	



USE

01 INTENDED USE

This product is intended for cutting weed, grass, or similar soft vegetation in areas that are hard to reach, e.g. under bushes, on slopes and edges. It may not be used to work on unusual thick, dry or wet grass, e.g. pasture grass, or to shred leaves.



NOTE: The trimmer head is parallel to the ground at a proper cutting distance without operator bending over (E).

STARTING/STOPPING THE LINE TRIMMER(FIG. F)

To Start

Press the lock-off button(2) then depress the on/off switch(1) (Fig. F). Different pressure on the on/off switch results in variable rotating speed of the cutting line. More pressure, higher speed.

To Stop

Release the lock-off button and the on/off switch.



NOTE: The motor runs only when the lock-off button and on/off switch are both pressed.



WARNING! Always remove the battery pack from the line trimmer during work breaks and after finishing work.

ADJUSTING CUTTING LINE LENGTH(FIG. G)

The bump head allows the operator to release more cutting line without stopping the motor. As line becomes frayed or worn, additional line can be released by lightly tapping the bump knob(10) on the ground while operating the trimmer.



NOTE: Line release will become more difficult as the cutting line becomes shorter.



WARNING! Do not remove or alter the line cutting blade assembly. Excessive line length will cause the motor to overheat and may result in serious personal injury.

USING THE LINE



WARNING! To avoid serious personal injury, wear goggles or safety glasses at all times when operating this unit. Wear a face mask or dust mask in dusty locations.

Clear the area to be cut before each use. Remove all objects, such as rocks, broken glass, nails, wire, or line, that can be thrown or become entangled in the cutting attachment. Clear the area of children, bystanders, and pets. At a minimum, keep all children, bystanders and pets at least 15m away; there still may be risk to bystanders from thrown objects. Bystanders should be encouraged to wear eye protection. If you are approached, stop the motor and cutting attachment immediately.

Trimming

Hold the product firmly with a gap between the product and your right side.

Stand upright, do not lean forward and pay attention to posture. Keep both feet apart to help retain your balance.

Hold the trimming head (8) just above the ground.

Avoid pressing it against the ground as this can ruin the lawn and damage the product.

Move the product with a slow regular arc from left to right before moving it back to the starting position and trimming the next area (Fig.H).



NOTE: Let the cutting device do the work. Let it work at its own pace, never press it into the area to be cut.

Ensure the cutting device remains clean and free from off-cuts that may cause it to jam. Check regularly. Release the on/off switch (2) and remove the battery pack (11) before checking.

Trim longer grass in stages; do not cut long grass in one cut (Fig. I1). For the best results, cut longer grass in steps (Fig. I2).

Wait until the product has come to a standstill before placing it down.

Tip

For best results, do not cut wet grass because it tends to stick to the trimming head (8) and guard, prevents proper discharge of grass trimmings, and could cause you to slip and fall.

Pay special attention when performing the work close to trees and bushes. The trimming

head (8) could damage sensitive bark, and damage fence posts (Fig. J).

Carefully manoeuvre the product around objects, such as trees and bushes, ensuring it does not come into contact with them.

OVERLOAD, TEMPERATURE AND CHARGING PROBLEM

PROBLEM	TOOL / BATTERY STATUS	POSSIBLE CAUSE	SOLUTION
Overload protection	Product suddenly stops	Extremely high torque, binding and stalling situations, overloading of the tool	Relieve the load immediately, reset the tool by switching off and back on again.
Temperature extremely high	The first and the third LED light of the POWER BAR will be flashing alternately	Battery temperature exceeds 77°C during operation	Cool down the battery to below 77°C for operation and below 57°C for charging.
Low charge	Power for the tool will drop quickly; The first LED on the POWER BAR begins to flash	The battery pack is under 5% charge	Remove the battery pack from the tool and charge it
Other problems	Short charges	Not fully charged	Make sure that battery is fully charged every time by allowing the charger to complete its full charging cycle
		Poor storage condition	Always remove battery from the tool and charger when not in use and store in a dry secure place. Avoid charging of storing your battery in temperatures below 5°C and above 40°C. Cool down a hot battery pack from a tool that has just been operated for approximately 30 minutes before storage



CARE & MAINTENANCE



WARNING! Always switch the product off, remove the battery pack and let the product cool down before performing inspection, maintenance and cleaning work!

Only perform care and maintenance work according to these instructions! All further works must be performed by a qualified specialist!

LINE SPOOL ASSEMBLY REPLACEMENT(K-M)



NOTE: Always use the recommended nylon cutting line spool assembly with a diameter that does not exceed 2.0 mm. Using line other than that specified may cause the brush cutter to overheat or become damaged.



WARNING! Always use original spare parts for replacement. Do not attach any other type of cutting device!

Press the two release buttons on the spool body and pull the spool retainer out (Fig. K). Place a new spool into its retainer with notches aligned with retainer eyelets (Fig. L). Align the retainer slots with the tabs on the spool base and press the retainer evenly down, ensuring that it snaps into place. (Fig. M)

NYLON LINE REWIND

Take out approximately 5m of new nylon cutting line with a diameter of 2.0mm.

Form a loop at the middle of the line and insert this loop into the hook on the spool, with one end of the line extending about 110 mm more than the other (Fig. N1).

Wind the two parts of the trimming line in an anticlockwise direction firmly around the spool. Ensure each part of the line is either side of the guide on the spool (Fig. N2).

Wind all nylon line just leaving 120mm length then place the line ends through the two opposite notches in the spool (Fig. N3).



WARNING! Ensure each part of the line is not across with each other. Otherwise that may cause the line feeding problem (Fig. O).

GUARD

Keep the trimming guard clean and free of debris. Remove trimmings.

Replace the trimming guard with one of the same type when it is worn or shows damage.

CLEAN

- Clean the product with a dry cloth. Use a brush for areas that are hard to reach.
- In particular clean the collet, switches and air vents after every use with a cloth and brush.
- Check for worn or damaged parts. Replace worn parts as necessary or contact an authorised service centre for repair before using the product again.



NOTE: Do not use chemical, alkaline, abrasive or other aggressive detergents or disinfectants to clean this product as they might be harmful to its surfaces.

MAINTENANCE

Your power tool requires no additional lubrication or maintenance.

There are no user serviceable parts in your power tool.

Before and after each use, check the product and accessories (or attachments) for wear and damage. If required, exchange them for new ones as described in this instruction manual. Observe the technical requirements.

TRANSPORTATION



WARNING! Always carry the product by its main handle.

- Switch the product off and remove the battery pack.
- Protect the product from any heavy impact or strong vibrations which may occur during transportation in vehicles.
- Secure the product to prevent it from slipping or falling over.

STORAGE

- Switch the product off and remove the battery pack.
- Clean the product as described above.
- Store the product and its accessories in a dark, dry, frost-free, well-ventilated place.
- Always store the product in a place that is inaccessible to children. The ideal storage temperature is between 10 °C and 30 °C.
- We recommend using the original package for storage or covering the product with a suitable cloth or enclosure to protect it against dust.

RECYCLING AND DISPOSAL



Waste electrical products should not be disposed of with household waste. Please recycle where facilities exist. Check with your Local Authority or retailer for recycling advice.

DISPOSAL OF AN EXHAUSTED BATTERY PACK



To preserve natural resources, please recycle or dispose of the battery pack properly. This battery pack contains Li-Ion batteries. Consult your local waste authority for information regarding available recycling and/or disposal options. Discharge your battery pack by operating your tool, then remove the battery pack from the tool housing and cover the battery pack connections with heavy-duty adhesive tape to prevent short circuit and energy discharge. Do not attempt to open or remove any of the components.



GUARANTEE

At **Erbauer** we take special care to select high quality materials and use manufacturing techniques that allow us to create ranges of products incorporating design and durability. That's why we offer a 3 year trade guarantee against manufacturing defects on our **Erbauer** power tool products.

This power tool is guaranteed for 3 years from the date of purchase, if bought in store, delivered or bought online. You may only make a claim under this guarantee upon presentation of your sales receipt or purchase invoice. Please keep your proof of purchase in a safe place.

This guarantee covers product failures and malfunctions provided the **Erbauer** power tool was used for the purpose for which it is intended and subject to installation, cleaning, care and maintenance in accordance with standard practice and with the information contained above and in the user manual. This guarantee does not cover defects and damage caused by or resulting from:

- Normal wear and tear, including accessory wear
- Overload, misuse or neglect
- Repairs attempted by anyone other than an authorised agent
- Cosmetic damage
- Damage caused by foreign objects, substances or accidents
- Accidental damage or modification
- Failure to follow manufacturer's guidelines
- Loss of use of the goods

This guarantee is limited to parts recognised as defective. It does not, in any case, cover ancillary costs (movement, labour) and direct and indirect damage.

If the **Erbauer** power tool is defective during the guarantee period, then we reserve the right, at our discretion, to replace the item with a product of equivalent quality and functionality or to provide a refund.

This guarantee only applies to the country of purchase or delivery and is not transferrable to any other countries. This guarantee is non-transferrable to any other person or product. Relevant local law will apply to this guarantee.

Guarantee related queries should be addressed to a store affiliated with the distributor you purchased the **Erbauer** power tool from.





This guarantee is in addition to and does not affect your statutory rights relating to faulty goods as a consumer.

CUSTOMER CARE AND TECHNICAL HELPLINE

A better way to repair your tools

Kingfisher takes special care in creating high-quality garden power tools that are designed to last. But if a fault develops with your garden power tool and you need to claim under the guarantee, the Customer Care and Technical Helpline can support with technical assistance or if required, arrange a free courier collection from your home, assess your garden power tool for fault, repair it, and return it.

Deciding to repair your product rather than buying a replacement and adding to the mountain of waste is a more sustainable choice and you will be doing your bit for the environment.

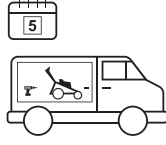
How does it work?				
				
Step 1 Find your proof of purchase and get in touch with the Customer Care and Technical Helpline.	Step 2 Chat to them about the problem with your tool.	Step 3 They will provide technical and user advice or alternatively arrange a courier collection from your home.*	Step 4 The team will assess and test and if necessary, repair your product back to full working order.	Step 5 Your repaired tool will be returned to you via courier within 5-7 working days*.



NOTE: *please note that before collection, all fuel must be removed from petrol powered machines

Get in touch

If you need help or more information, please contact the Customer Care and Technical Helpline:

UK: 0800 0789647

Eire: 1800 932226

Opening hours are Monday – Friday, 8am-5pm

AVAILABILITY OF SPARE PARTS

Contact the customer service helpline for assistance or visit www.kingfisherspares.com

For assistance contact the customer services helpline:

UK 0800 0789647 uk@Kingfisherservice.com

EIRE 1800 932226 eire@kingfisherservice.com

Further information about this product can also be found at:

www.kingfisher.com/products

01 TECHNICAL SPECIFICATIONS

Rated voltage:	18V dc
Rated no load speed n_0 :	7000/min
Cutting Line Type:	2.0mm
Cutting Width:	300mm
Total length for cutting means:	5m
Weight (without battery pack):	2.8 kg

Ambient temperature range for tool and battery use: 0°C to 40°C

For use with battery pack and charger as below:

Battery pack model: EBAT18-Li-2 / EBAT18-Li-4 / EBAT18-Li-5 / EHPB18-Li-4/ EHPB18-Li-8

Charger model: EC18-Li / EFC18-Li / EMC18-Li

Measured sound power level L_{WA} : 90.67 dB(A)

Uncertainty K: 3.75 dB(A)

Sound pressure level at operator's position L_{PA} : 76 dB(A)

Uncertainty K: 2.5 dB(A)

Guaranteed sound power level L_{WA} : 96 dB(A)

Valuation of vibration a_n : 3.907m/s²

Uncertainty K: 1.5 m/s²

The sound values have been determined in accordance with ISO 22868, using the basic standards EN ISO 11094 and EN ISO 3744.

The sound intensity level for the operator may exceed 80 dB(A) and ear protection measures are necessary.

The declared vibration value has been measured in accordance with a standard test method (according to EN 50636-2-91) and may be used for comparing one product with another.

The declared vibration value may also be used in a preliminary assessment of exposure.



WARNING! The vibration emission value during actual use of the tool can differ from the declared value depending on the ways in which the tool is used. Identify safety measures to protect the operator that are based on an estimation of exposure in the actual conditions of use (taking account of all parts of the operating cycle such as the times when the tool is switched off and when it is running idle in addition to the trigger time).

Depending on the actual use of the product the vibration values can differ from the declared total. Adopt proper measures to protect yourself against vibration exposures. Take the whole work process including times the product is running under no load or switched off into consideration.

Proper measures include among others regular maintenance and care of the product and accessories, keeping hands warm, periodical breaks and proper planning of work processes.

RATING LABEL EXPLANATION

EGT18-Li = MODEL NUMBER

E = ERBAUER

GT=GRASS TRIMMER

18 =18 V d.c.

Li = LITHIUM

02 SYMBOLS

On the product, the rating label and within these instructions you will find among others the following symbols and abbreviations. Familiarize yourself with them to reduce hazards like personal injuries and damage to property.

V~	Volt, (alternating voltage)	V 	Volt, (direct current voltage)
W	Watt	Hz	Hertz
mA	Milliampere	mAh	Milliampere-hour
A	Ampere	/min	per minute
mm	Millimetre	kg	Kilogram

dB(A) Decibel (A-rated) m/s^2 Metres per second squared

yyWxx Manufacturing date code; year of manufacturing (20yy) and week of manufacturing (Wxx)



Lock / to tighten or secure



Unlock / to loosen



Caution / Warning.
Read the instruction manual.



Wear hearing protection.



Wear head protection, where there is a risk of falling objects.



Wear respiratory protection.



Wear protective gloves



Wear eye protection.



Wear protective, slip-resistant footwear



Do not expose to rain or wet conditions.



Switch the product off and remove the battery pack to disconnect from the power supply before assembly, cleaning, adjustments, maintenance, storage and transportation.



Inspect the area where the product is to be used and remove all objects which can be thrown by the product. If objects are hidden while operating stop the engine and remove the object.



Beware of thrown objects. Keep bystanders away. The distance between the machine and bystanders shall be at least 15m.

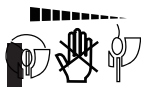

Warning! Cutting device continues to rotate after the motor is switched off.



Maximum rotational frequency of the spindle in $/min$



Beware of blade thrust!



This unit is not intended for use with a toothed saw type blade. Do not use toothed blade!

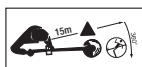

Ensure that other people and pets remain at least 15m away from the grass trimmer when it is in use.



Do not dispose of battery packs in rivers or immerse in water.



Do not dispose of battery packs in fire. They will explode and cause injury.



Do not expose battery packs to heat in excess of 40°C



The product complies with the applicable European directives and an evaluation method of conformity for these directives was done.



Guaranteed sound power level



WEEE symbol. Waste electrical products should not be disposed of with household waste. Please recycle where facilities exist. Check with your Local Authority or local store for recycling advice.

Manufacturer,Fabricant,Producent,Producător,Fabricante:

UK Manufacturer:
Kingfisher International Products Limited
3 Sheldon Square London, W2 6PX
United Kingdom
www.kingfisher.com/products

EU Manufacturer:
Kingfisher International Products B.V.
Rapenburgerstraat 175E
1011 VM Amsterdam
The Netherlands
www.kingfisher.com/products

EN	www.diy.com www.screwfix.com www.screwfix.ie	To view instruction manuals online, visit www.kingfisher.com/products
FR	www.castorama.fr www.bricodepot.com	Pour consulter les manuels d'instructions en ligne, rendez-vous sur le site www.kingfisher.com/products
PL	www.castorama.pl	Aby zapoznać się z instrukcją obsługi online, odwiedź stronę www.kingfisher.com/products
ES	www.bricodepot.es	Para consultar los manuales de instrucciones en línea, visite www.kingfisher.com/products
PT	www.bricodepot.pt	Para consultar manuais de instruções online, visite www.kingfisher.com/products
RO	www.bricodepot.ro	Pentru a consulta manualele de instrucțiuni online, vizitați www.kingfisher.com/products
TR	www.koctas.com.tr	Kullanım kılavuzuna internet üzerinden ulaşmak için www.kingfisher.com/products adresini ziyaret edin