

Automatic Faucet Series

User's Manual

*Thank you for choosing the automatic faucet.

Features:

1. The water will only flow when hands are put within range of the sensor, as soon as the hands are removed the flow will stop. This contributes to considerable water savings.
2. After installation the faucet is in touch free operation, this reduces the risk of transfer of bacteria.
3. SCM control provides a limited water flow of maximum one minute, even when fixed objects are still within range of the sensor.
4. Control box is separated, which could be choose box #1 or box #2 according to requirements, convenient changing between AC, DC and AD (applies to control box #1 only) is available.
5. Faucet body made of high quality brass; Supremely accurate machining; process with precise surface finish such as polish, nickel coated and chrome coated, the working life is guaranteed.

Specifications:

Model	DC	AC	AD
Power Supply	DC:6V	AC:100-240V 50-60Hz	AC:100-240V 50-60Hz DC:6V(Auto Switch)
Applicable Water Pressure			0.05-0.8MPa
Water Temperature			0.1-60°C
Environment Temperature			0.1-60°C
Water Supplying Caliber			G1/2" G3/8"

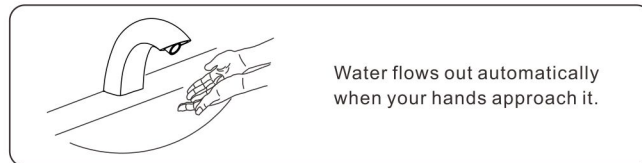

Installation guide:

- *Please connect the supplied flexible hose to the water inlet connection on the control box.
- *Please follow the instructions in drawing 1 if only cold water is used.
- *In case of using both hot and cold water supply, please install a mixing valve prior to connection to the control box in accordance with drawing 2.
- *Install the control box on the wall in accordance with appropriate EU regulations for safety and/or applicable local standards.
- *Install the faucet on the wash hand basin or on the wall according to the faucet you have , please review drawing 1-7 for reference.
- *Connect the flexible hose to the water outlet connection on the control box.
- *Connect the sensor cable to the control box.
- *Make sure all water connections are tested and found without leakage prior to switching on the power the control box.
- *Plug in the power cable and/or install 4 AA alkaline batteries

A. Basin faucet 1 (for #1 control box)

Install the faucet according to drawing 1, 2 .

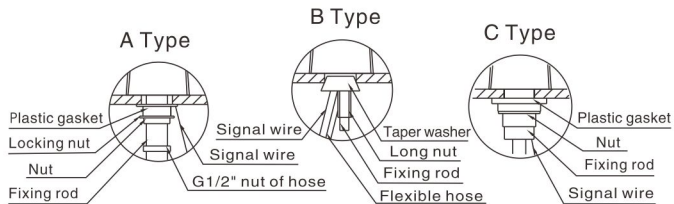
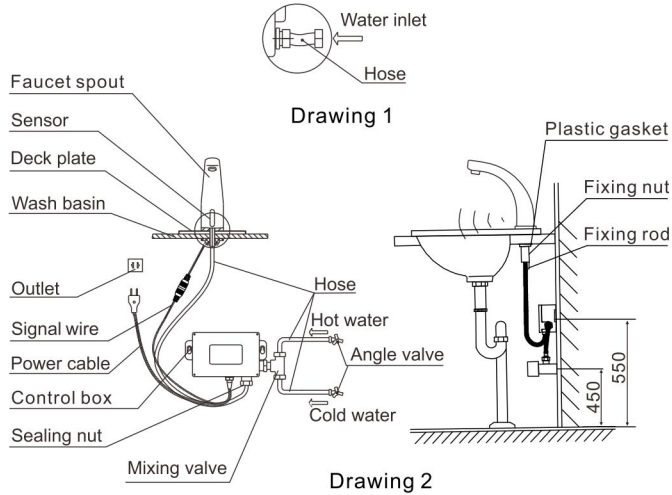

A. Basin faucet 2 (for #2 control box)

Install the faucet according to drawing 3, 4 .

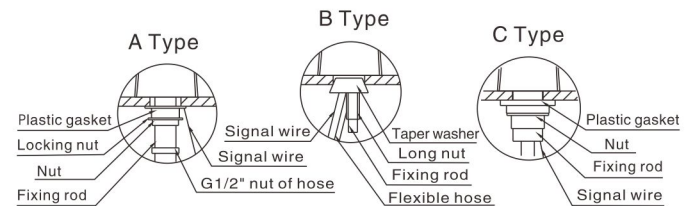
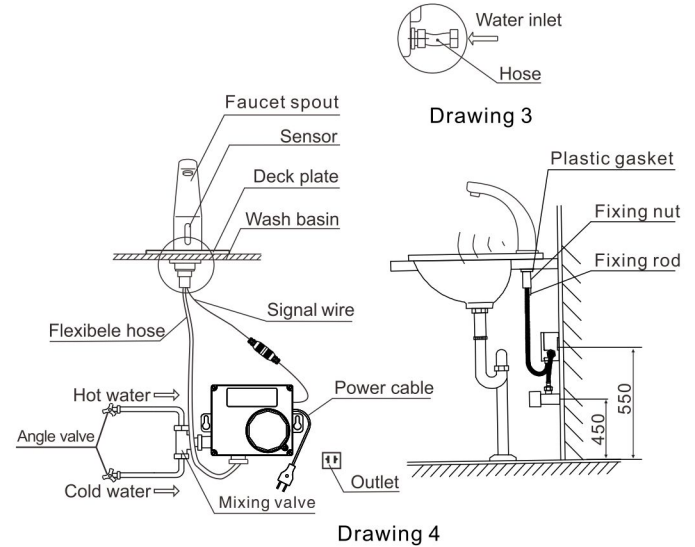

B. Wall mounted faucet 1

Install the faucet according to drawing 5,6.

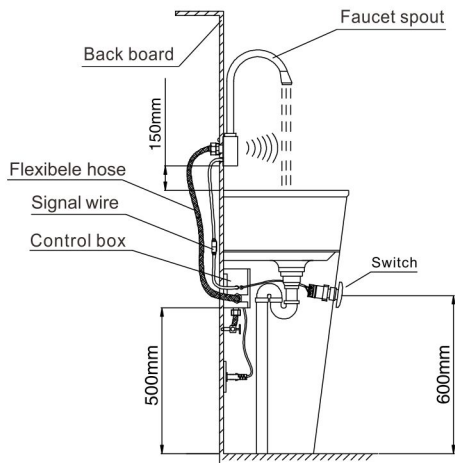

Drawing 5

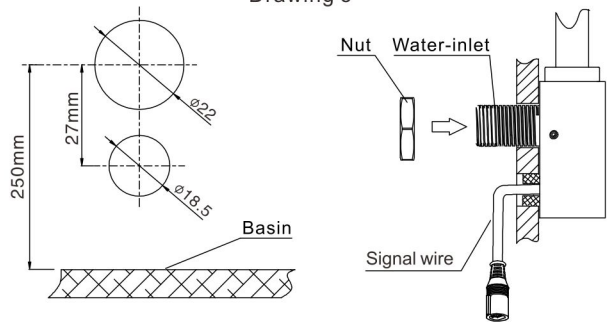

Drawing 6

B. Wall mounted faucet 2

Install the faucet according to drawing 7.

Dimensions for reference

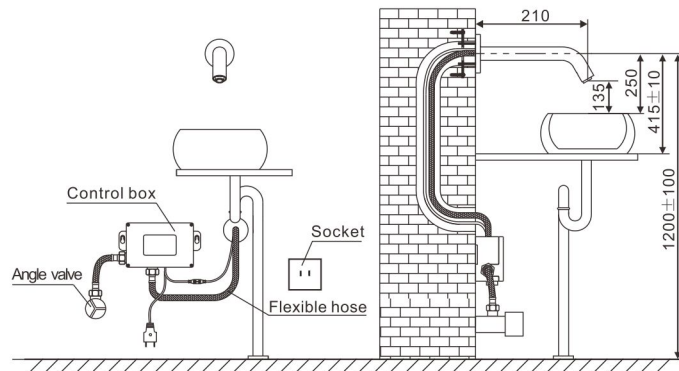

Drawing 7

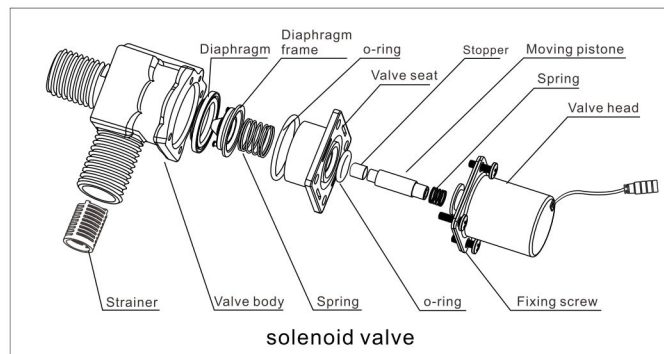

solenoid valve

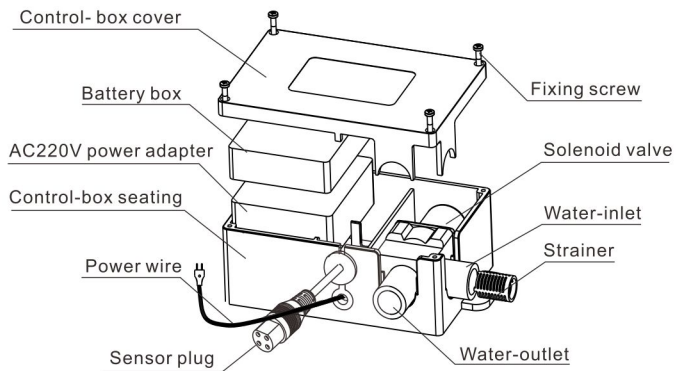

Control box #1

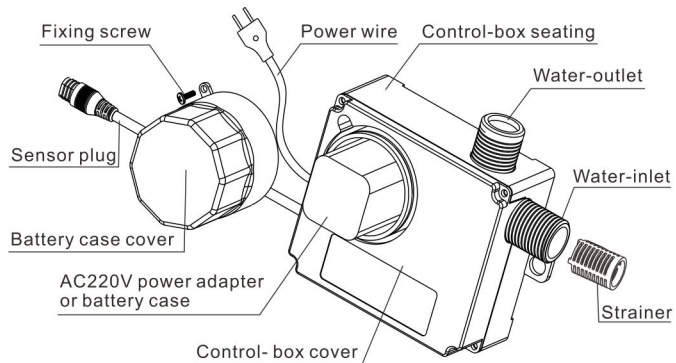

Control box #2

Instructions for use:

1. Sensor/flow test.

*When the unit is powered on, water should flow immediately when you put your hands within range of the sensor. When you remove your hands out range the water should stop immediately.

*The maximum duration of continuous flow is 1 minute.

2. Sensor range

*The default factory set distance is 12~15 cm. When powered on for the first time, place your hands at the desired distance within 5 seconds after the power has been switched on and remove your hands after approx 2 seconds in order to change the factory setting.

*To reset the setting, interrupt power for at least 30 seconds and follow the procedure as described to set the sensor range correctly.

3. Strainer

*To prevent blockage please clean the strainer regularly, make sure you shut off the water mains, unscrew the water inlet hose, remove the strainer, clean with water and a soft brush. Then install the items in reverse order, turn on water mains and check for leakage.

4. Battery Change:

*The indicator light in the sensor will flicker 3 times per second to indicate the batteries are at the end of their useful life. At this stage the unit will not operate in battery mode anymore.

*In case you have plugged in the mains, disconnect power and open the cover of the control box, open the battery holder, remove the batteries and replace all batteries with new ones.

- *Please make sure you install the batteries in the right direction, the + and – side are indicated in the battery holder.
- *Close the battery holder, place the cover back in place and tighten the screws.
- *Follow the instructions for setting the sensor range if required.

Problem:

- *The unit does not work.
- *Please check for power connection or replace the batteries, check connection of the sensor cable.
- *There is power however no water flow.
- *Please check the water supply, open any closed valves if necessary.
- *Check water connections for blockage, clean if necessary.
- *Check Strainer for Blockage, clean if necessary.
- *Disconnect power for 30 seconds and reinstall.
- *Check water connections for twists.
- *Check sensor cable connection.
- *Clean the sensor with a soft cloth.

Caution:

- *Please handle the product with care whilst installing.
- *Only clean with soft cloth, no abrasive cleaning agent, acidulous cleaning agents.
- *Do not spray the control box with water.
- *Only clean the sensor with a soft cloth, scratching will reduce the range and sensitivity of the unit itself

Warranty:

- *For guarantee, please refer to the terms and conditions of supply for your country.

Different faucet shape for optional

