

Setup Guide
 Guide de configuration
 Einrichtungsanleitung
 Guida alla configurazione
 Guía de instalación
 Opsætningsvejledning
 Konfigureringsveiledning
 Installationsguide
 Asennusopas
 Installatiegids

Spotlight Cam Plus | Plug-In

 ring.com/manuals

Download the full manual online.
 Téléchargez le manuel complet en ligne.
 Laden Sie das vollständige Handbuch online herunter.
 Scarica il manuale completo online.
 Descarga el manual completo en línea.
 Download de volledige handleiding online.
 Last ned hele håndboken på nett.
 Ladda ner hela handboken online.
 Lataa kokonainen opas verkosta.
 Download hele vejledningen online.



Hardware included / Matériel inclus / Enthaltene Befestigungsteile / Viteria inclusa / Materiales incluidos / Inbegrepen gereedschap / Inkludert festemidler / Medföljande hårdvara / Sisältää kiinnikkeet / Hardware medfølger

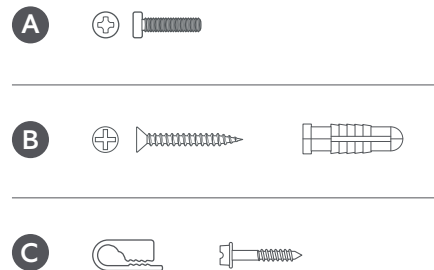

Tools needed / Outils requis / Erforderliches Werkzeug / Attrezzi necessari / Herramientas necesarias / Benodigd gereedschap / Nødvendig værktøj / Verktøgen som behøvs / Vaatii työkalut / Nødvendigt værktøj



! Remove protective film / Retirer le film protecteur / Schutzfolie entfernen / Rimuovi la pellicola protettiva / Retira el plástico protector / Beschermfolie verwijderen / Fjern beskyttelsesfolien / Ta bort den skyddande filmen / Poista suojakalvo / Fjern beskyttelsesfilmen

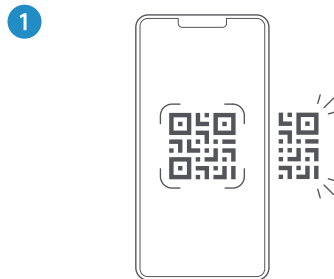

Continue setup in Ring app / Poursuivre la configuration dans l'application Ring / Mit der Einrichtung in der Ring-App fortfahren / Continua la configurazione nell'app Ring / Continúa la configuración en la app de Ring / Open de Ring-app om te configureren / Fortsett konfigurasjonen i Ring-appen / Fortsätt konfigurationen i Ring-appen / Jatka asennusta Ring-sovelluksessa / Fortsæt konfigurationen i Ring-appen

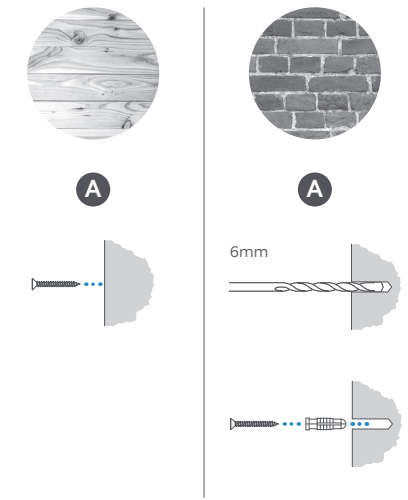
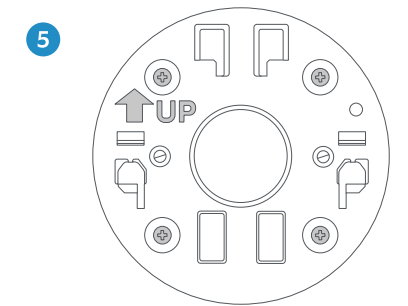
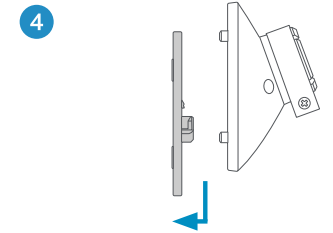
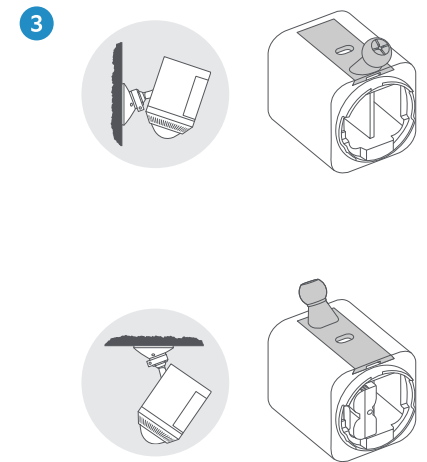
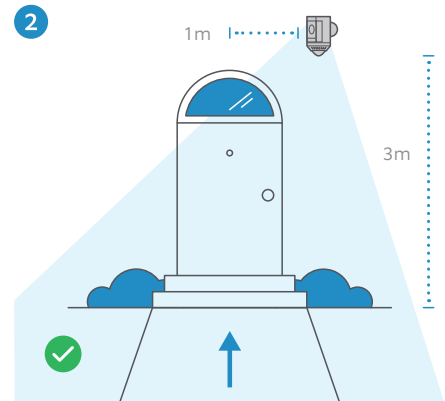



WARNING! Only use the included mounting screws when securing the mounting plate / **ATTENTION !** Veuillez n'utiliser que les vis de fixation fournies lors de l'installation de la plaque de fixation / **ACHTUNG!** Zum Befestigen der Montageplatte nur die enthaltenen Schrauben und Dübel verwenden / **AVVERTENZA!** Per fissare la piastra di montaggio usa solamente le viti di montaggio fornite a corredo / **ADVERTENCIA:** Utiliza únicamente los tornillos de montaje incluidos para fijar la placa de soporte / **WAARSCHUWING!** Gebruik alleen de inbegrepen montage-schroeven voor het bevestigen van de montageplaat / **ADVARSEL!** Bruk kun de medfølgende skruene og pluggene for å feste monteringsplaten / **VARNING!** Använd endast de monteringssskruvar som följer med när du skruvar fast monteringsplattan / **VAROITUS!** Käytä ainoastaan mukana toimitettuja kiinnitysruuveja kiinnityslevyn kiinnittämiseen / **ADVARSEL!** Brug kun de medfølgende monteringssskruer, når du fastgør monteringspladen



CAUTION! DO NOT drill into your home's electrical wiring / **MISE EN GARDE !** Ne percez pas le câblage électrique de votre maison / **ACHTUNG!** NICHT in die bestehende Verkabelung bohren / **ATTENZIONE!** NON praticare fori nell'impianto elettrico della tua abitazione / **PRECAUCIÓN:** NO perfores ni taladres el cableado eléctrico de tu casa / **PAS OP MET BOREN!** Zorg ervoor dat je GEEN elektrische bedrading raakt / **ADVARSEL!** IKKE bor i husets eksisterende ledninger / **VARNING!** BORRA INTE i ditt hems elsladdar / **HUOMIO!** ÄLÄ poraa kotisi sähköjohtoihin / **FORSIGTIG!** Du må IKKE bore i elledningerne i dit hjem

6

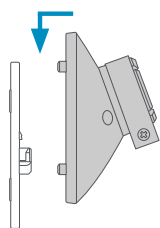

7

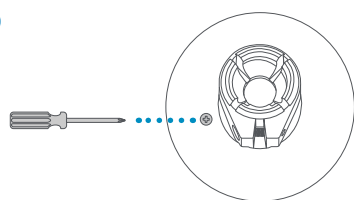

8

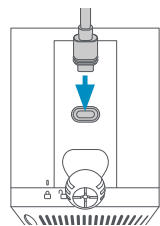

8

9

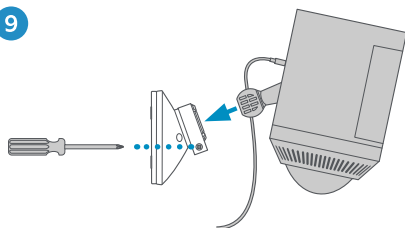

10

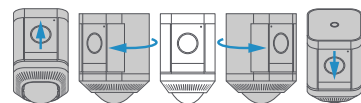

11

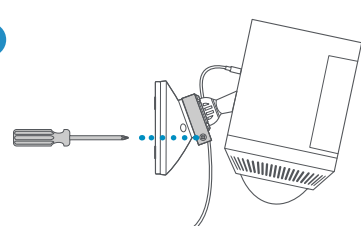

9

12

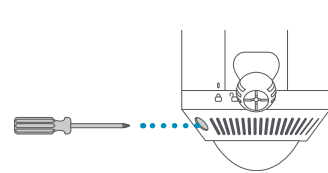

13

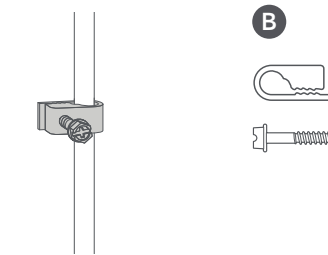

14

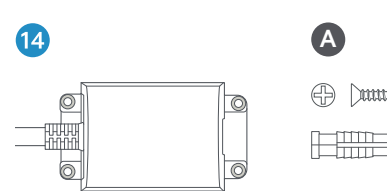

12



Choose the plan that works for you.



Protect Basic

One doorbell or cam.
Unlimited moments captured.
One flat price.

Protect Plus

Ring Alarm and unlimited devices at one location. Still unlimited moments captured. Still one flat price.

What is Ring Protect?

All Ring devices feature Live View, Two-Way Talk and Motion Detection free of charge. Get even more out of your device with an optional subscription to Ring Protect, so you can record, review and share the moments you missed. Your new Ring device includes a free 30-day trial. To extend your subscription and save your videos, visit ring.com/protect-plans.

Qu'est-ce que Ring Protect?

Les appareils Ring disposent tous gratuitement de la vidéo en direct, du système audio bidirectionnel et de la détection de mouvements. Tirez le meilleur de votre appareil grâce à l'abonnement facultatif à Ring Protect, qui vous permet d'enregistrer, revoir et partager les moments que vous avez manqué. Votre nouvel appareil Ring comprend un essai gratuit de 30 jours. Pour prolonger votre abonnement et sauvegarder vos vidéos, rendez-vous sur ring.com/protect-plans.

Was ist Ring Protect?

Alle Ring-Geräte verfügen über Live-Video, Gegensprechfunktion und Bewegungserkennung. Holen Sie mit einem Ring Protect-Abonnement noch mehr aus Ihren Ring-Geräten heraus. Damit können Sie Videos von verpassten Ereignissen aufnehmen, jederzeit erneut ansehen und mit anderen teilen. Ihr neues Ring-Gerät enthält eine kostenlose 30-Tage-Testversion von Ring Protect. Um Ihr Abonnement zu verlängern und Ihre Videos zu speichern, besuchen Sie ring.com/protect-plans.

Che cos'è Ring Protect?

Tutti i dispositivi Ring offrono gratuitamente la funzionalità Live View, il sistema audio bidirezionale e la rilevazione di movimento. Con un abbonamento facoltativo a Ring Protect, potrai trarre il massimo dal tuo dispositivo: potrai registrare, rivedere e condividere i momenti che ti sei perso. Il tuo nuovo dispositivo Ring comprende una prova gratuita di 30 giorni. Per prolungare l'abbonamento e salvare i tuoi video, visita ring.com/protect-plans.

¿Qué es Ring Protect?

Todos los dispositivos Ring cuentan con vídeo en directo, comunicación bidireccional y detección de movimiento gratis. Sácale mucho más partido a tu dispositivo con una suscripción a Ring Protect para poder grabar, volver a ver y compartir los momentos que te has perdido. Tu nuevo dispositivo Ring incluye un periodo de prueba gratuito de 30 días. Si quieres ampliar la suscripción para poder guardar tus vídeos, visita ring.com/protect-plans.



ring

ring.com/help

EU + 800 8700 9781

UK + 44 1727 26 3045



Ring
38 Avenue John F. Kennedy
L-1855
Luxembourg

Ring
1 Principal Place, Worship Street
London, EC2A 2FA
United Kingdom

© 2022 Ring LLC or its affiliates. Ring and all related marks are trademarks of Ring LLC or its affiliates.

22-004440-02