

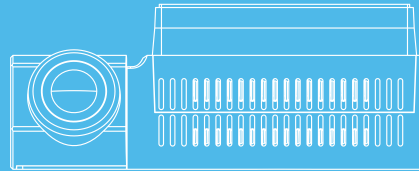

Ring Smart Dash Cam 4000 Quick Start Guide

- FR** Caméra de tableau de bord intelligente Ring 4000
Guide de démarrage rapide
- DE** Intelligente Ring Armaturenbrettkamera 4000
Kurzanleitung
- ES** Cámara inteligente para salpicadero 4000 de Ring
Guía de inicio rápido
- IT** Ring Dash Cam intelligente 4000
Guida rapida
- NL** Ring Smart Dash Cam 4000
Beknopte handleiding



What's included

FR Ce qui est inclus **DE** Was enthalten ist **ES** Se incluye **IT** Cosa include **NL** Inbegrepen

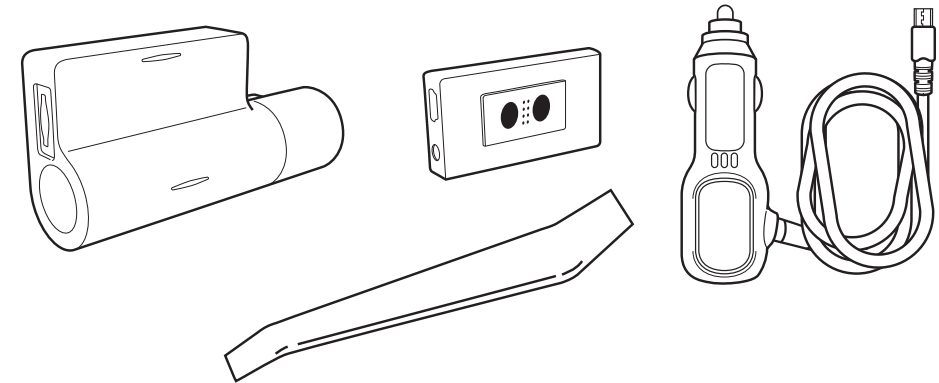

1

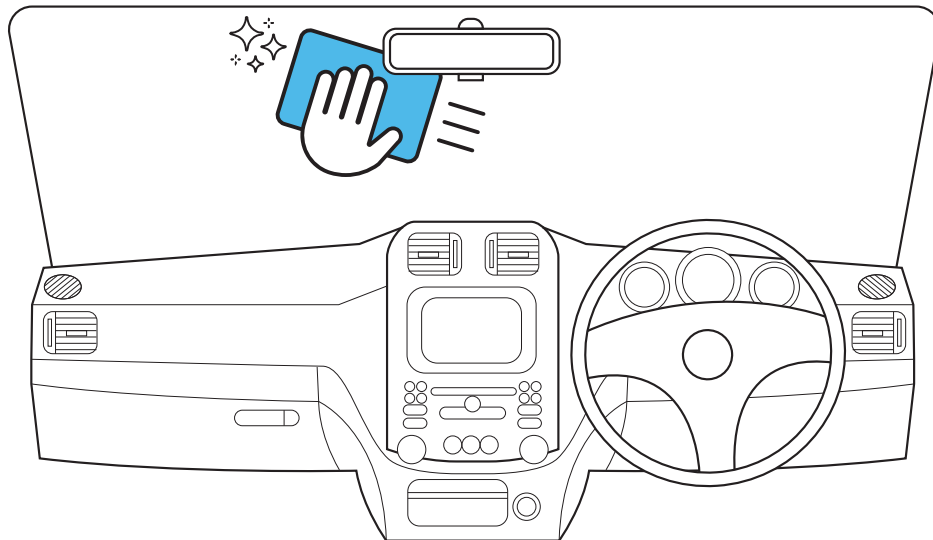

2

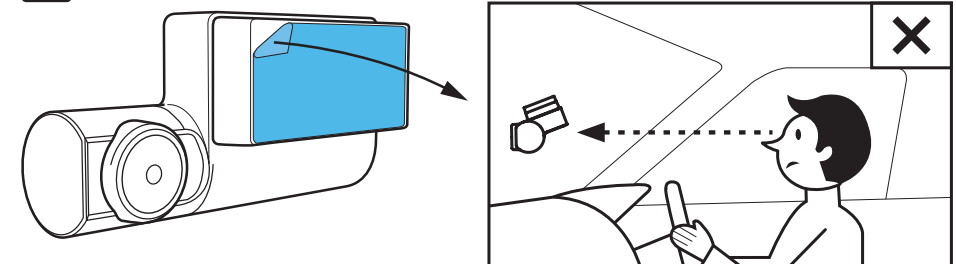

Place behind rear view mirror for a better driving experience.

- FR** Placez-la derrière le rétroviseur, pour de meilleures conditions de conduite.
- DE** Hinter dem Rückspiegel platzieren, um uneingeschränkte Sicht aufrechtzuerhalten.
- ES** Colóquela detrás del espejo retrovisor para una mejor experiencia de conducción.
- IT** Posizionare dietro lo specchio retrovisore per una migliore esperienza di guida.
- NL** Plaats de dashcam achter de binnenspiegel zodat u er bij het rijden geen last van hebt.

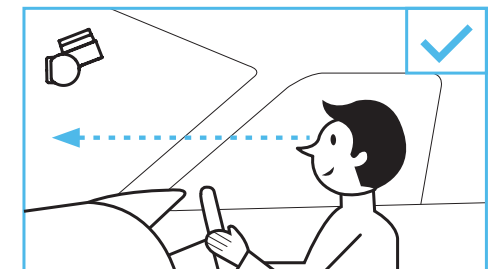

3

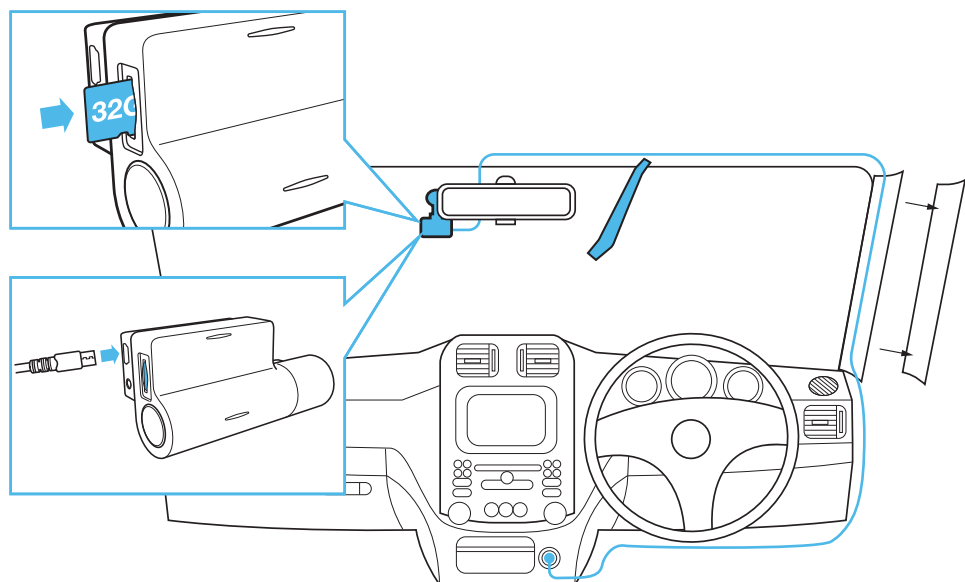

4

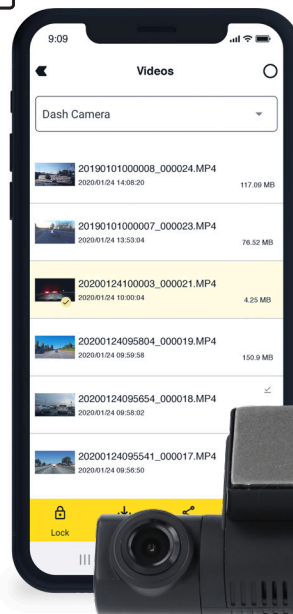

Download

- FR Télécharger
- DE Herunterladen
- ES Descargar
- IT Download
- NL Downloaden



5

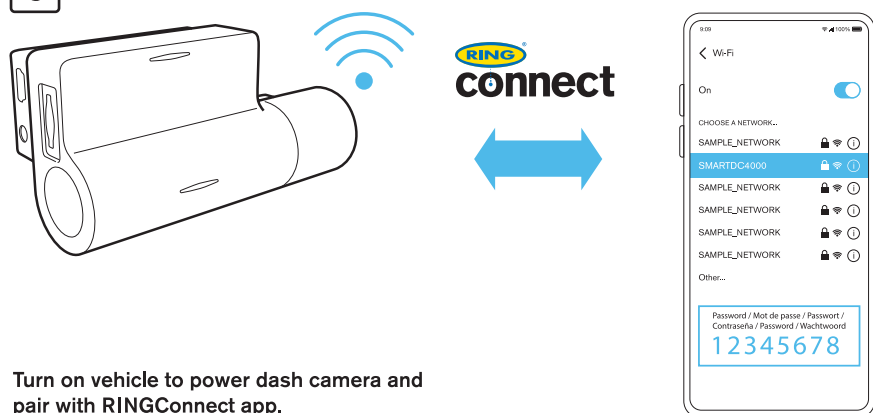

Turn on vehicle to power dash camera and pair with RINGConnect app.

- FR Mettez le véhicule en marche pour alimenter la caméra de tableau de bord et la jumeler avec l'application Ring Connect.
- DE Die Zündung einschalten, um die Armaturenbrettkamera mit Strom zu versorgen und mit der Ring Connect App zu koppeln.
- ES Arranque el vehículo para encender la cámara del salpicadero y vincule la aplicación Ring Connect.
- IT Accendere il veicolo per alimentare la Dash Cam e abbinarla all'app Ring Connect.
- NL Zet het contact van de auto aan om de dashcam in te schakelen en te koppelen met de Ring Connect App.

Ring Automotive Limited
 Gelderd Road, Leeds, LS12 6NA
 United Kingdom
 Telephone +44 (0)113 213 2000
 Email autosales@ringautomotive.com

OSRAM GmbH
 Nonnendammallee 44,
 13629 Berlin, Germany
 Email: automotive-service@osram.com





Ring Smart Dash Cam 4000

Dashcam HD 1296p

English

 **Deutsch**

 **Français**

 **Español**

 **Italiano**

 **Dutch**

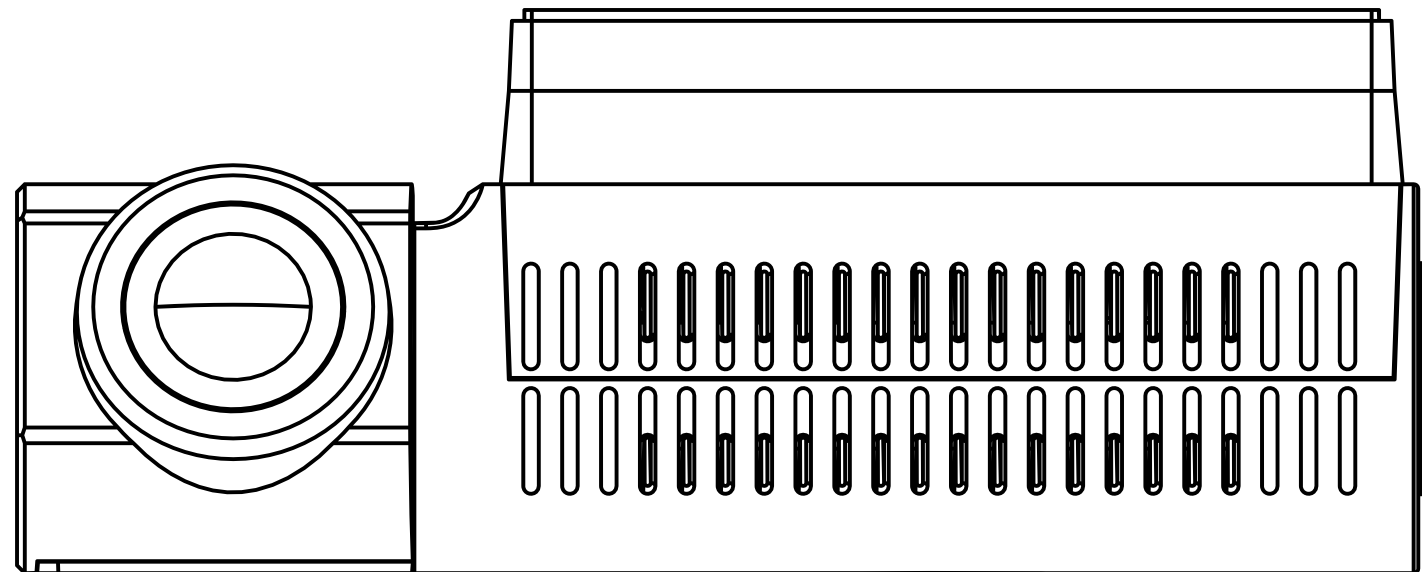



WARNING

- 1** Individual special requirements and legislation of the countries must be observed, especially concerning the duration of the records/use and the transfer of data. Please make yourself familiar with the data protection laws of your country and ensure that you comply with them. Please also familiarize yourself and comply with the relevant laws and regulations regarding the use and ownership of dash cameras in your country.

DE/AT: Permanent and occasion-free recordings are not permitted, i.e. no recording of the entire route, license plates or strangers (so-called loop function). When recording an event, e.g. an accident, all parties involved must be informed about the recording and about its transfer to the police. No posting of recordings in public media (Internet, social media) without the consent of all persons concerned or only after disguising the persons and license plates. It must be impossible to draw conclusions about persons, e.g. through pictures of the surroundings.

- 2** The dashcam must not be fitted in a position which obscures the driver's view of the road ahead.
- 3** Only use the supplied power adapter, otherwise damage may occur to the dashcam. Take care when cleaning the dashcam lens and only use a suitable lens cleaner and a soft cloth. Do NOT expose this product to rain, moisture or water under any circumstances; doing so may result in the risk of electric shock or fire. Do NOT perform servicing other than that contained in the instruction manual, unless you are qualified to do so. When installing in a vehicle, always place the device securely against the windscreen and where possible conceal the power cable under the vehicles interior trim. Make sure that the power cable doesn't interfere with the driver's controls such as the steering wheel, pedals or gear lever. Do NOT mount the dashcam in front of an airbag deployment area or in a position to obscure any interior mirrors. Do NOT operate while driving and only adjust settings or review recordings while not driving.



BEFORE YOU BEGIN

If you haven't already downloaded the app, do so now to get the most from your dashcamera.

- 1 Download the app by searching for RINGconnect in the App Store (iPhone) or Google Play (Android).
- 2 Open the app, follow the setup process shown and enable all necessary settings when prompted.

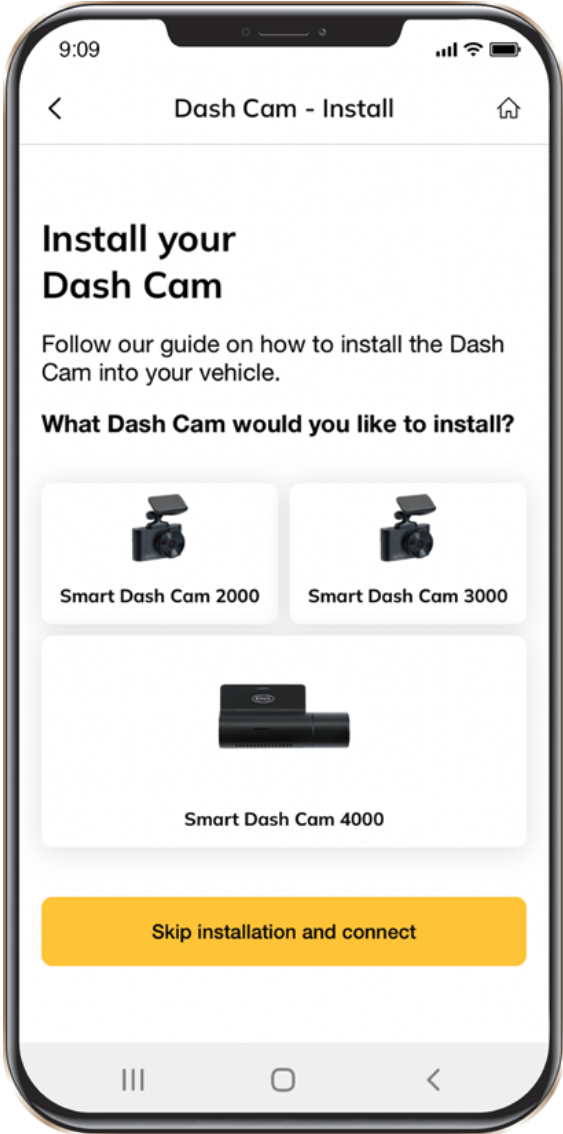



PACKAGE CONTENTS

- 1 Dashcam
- 2 Quick Start Guide
- 3 Magnetic Mount
- 4 USB Charging Cable
- 5 Trim Removal Tool
- 6 Window Sticker

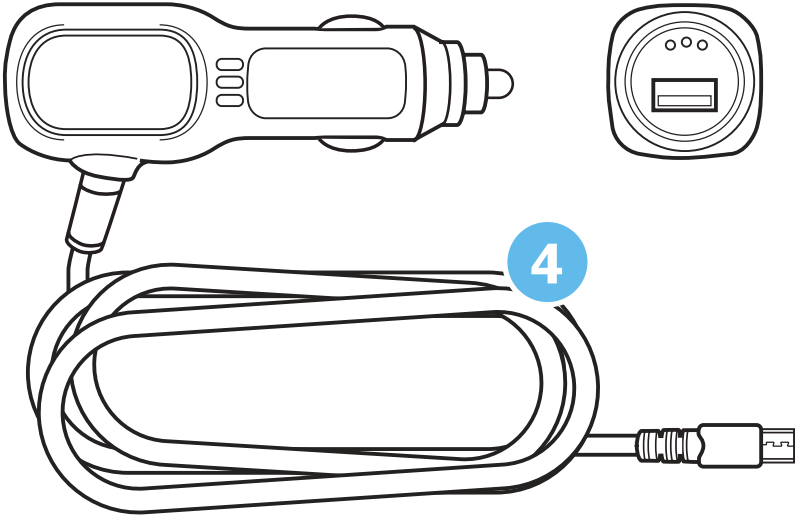
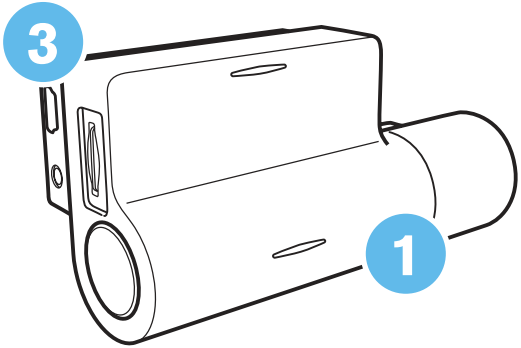
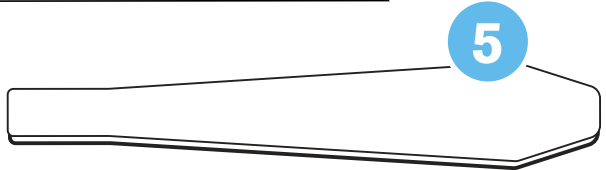
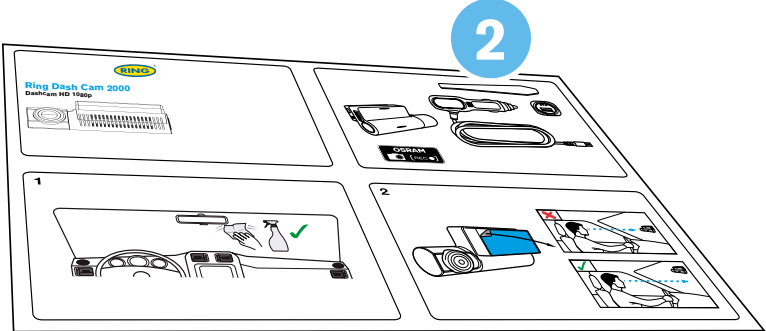



ATTENTION! Choose the installation location in advance, as the adhesive tape on the mount is of single use.

- 1** Ensure glass is dirt, dust and grease free.
- 2** Warm adhesive pad part of mount in hands to ensure strong adhesion to glass.
- 3** Once mount has been positioned connect dashcamera to the magnetic mount.

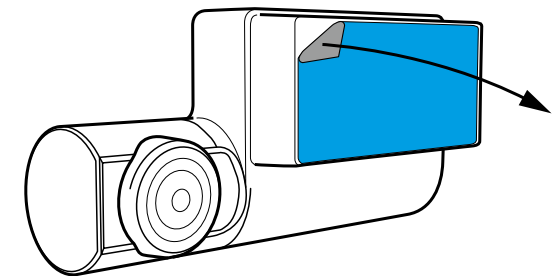
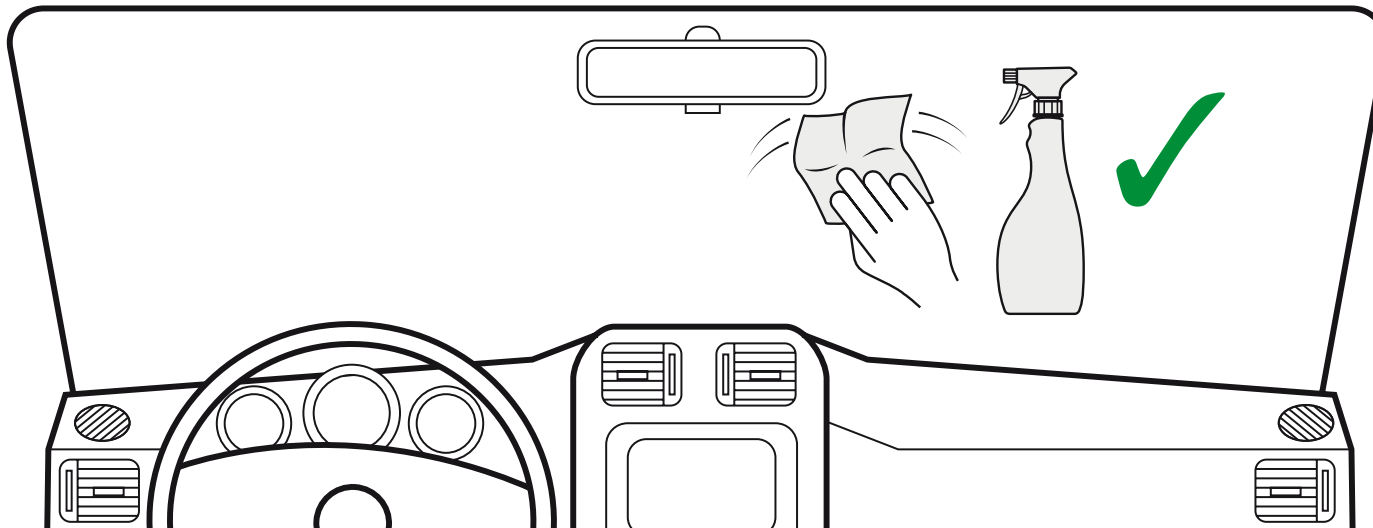



To power the device and charge the battery, use only the power adapter included. Connect the power cable to the mount, and then plug the USB charger into the vehicles 12V power socket.

When the vehicle's engine starts, the device turns on automatically.

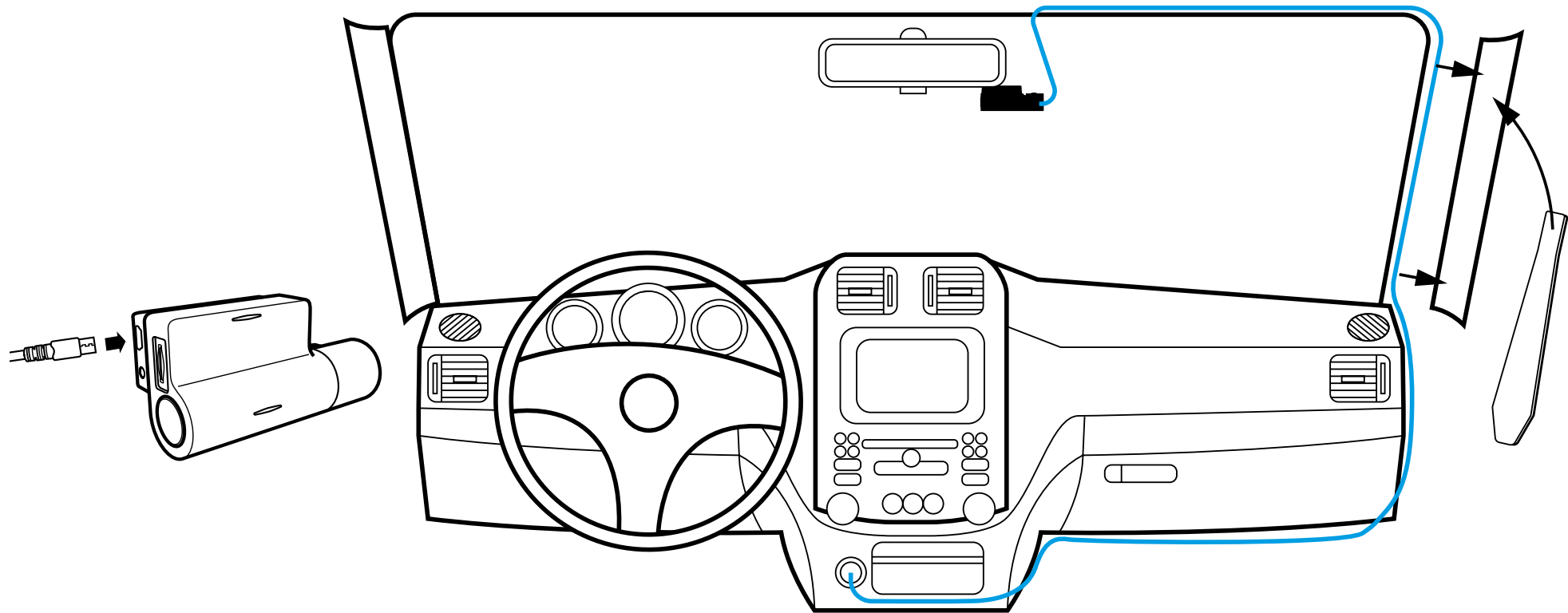



INSTALLING microSD CARD

- 1** Before installing a memory card, make sure the device is turned off.
- 2** Insert the memory card until it clicks into place.
- 3** Removing a card: press the card slightly and then remove it from the slot.

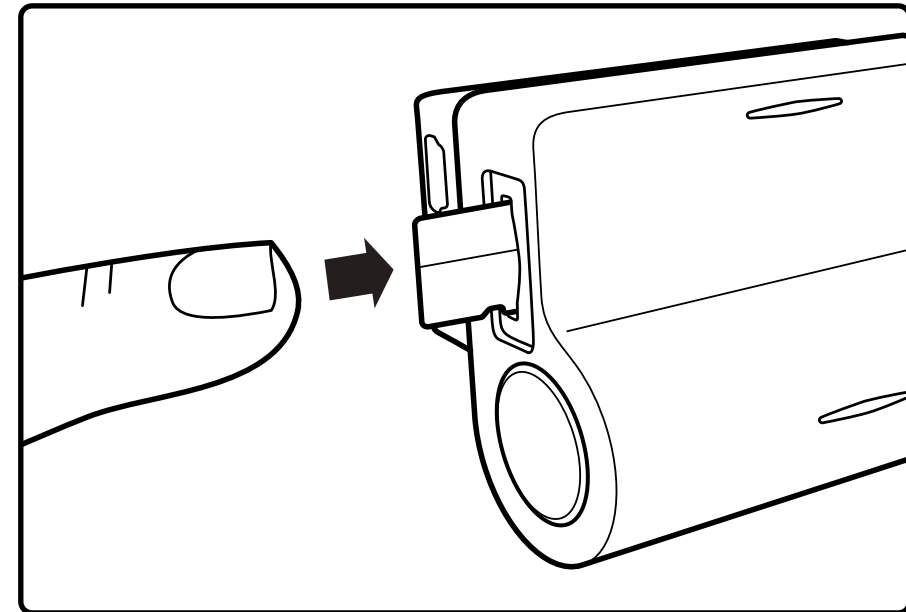

WARNING! Do not apply excessive force when inserting a memory card to avoid damage to the device. If necessary, use a thin pointed device to push the card further. To remove the memory card, push the card until it clicks and remove the card from the slot.



TURNING ON/OFF

- When the vehicle ignition is turned ON the dashcam turns on automatically.
- To turn the device on manually, press the power button.
- To turn the device off press and hold the power button for approx. 3 seconds.

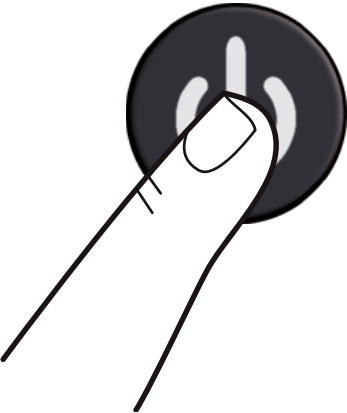
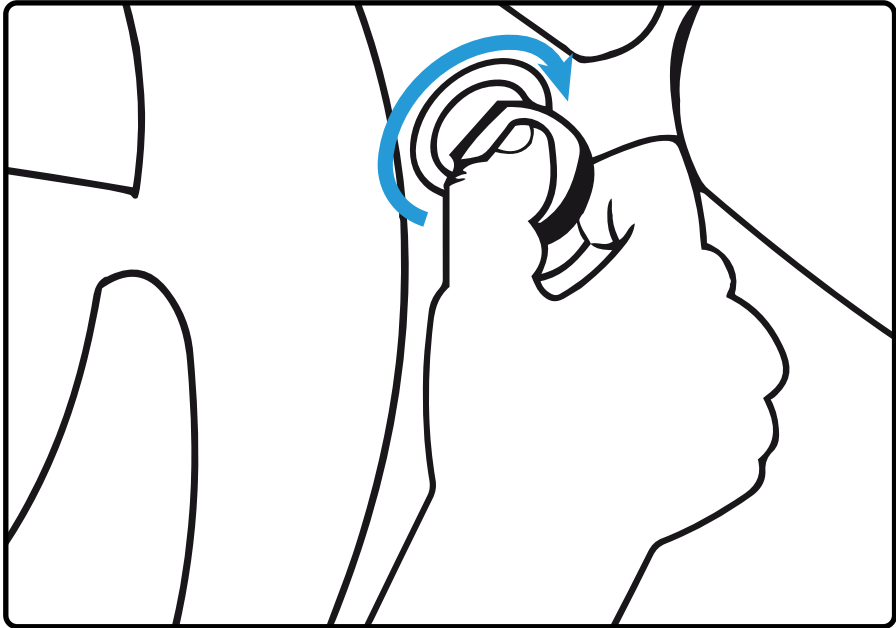



CONNECTING TO MOBILE

- 1 Switch on dashcam.
- 2 Your camera automatically broadcasts a Wi-Fi network.
- 3 Open your phone's Settings.
- 4 Tap on Wi-Fi or Connections.
- 5 Select the dashcam hotspot and enter the password "12345678".
- 6 You are now connected to your device.

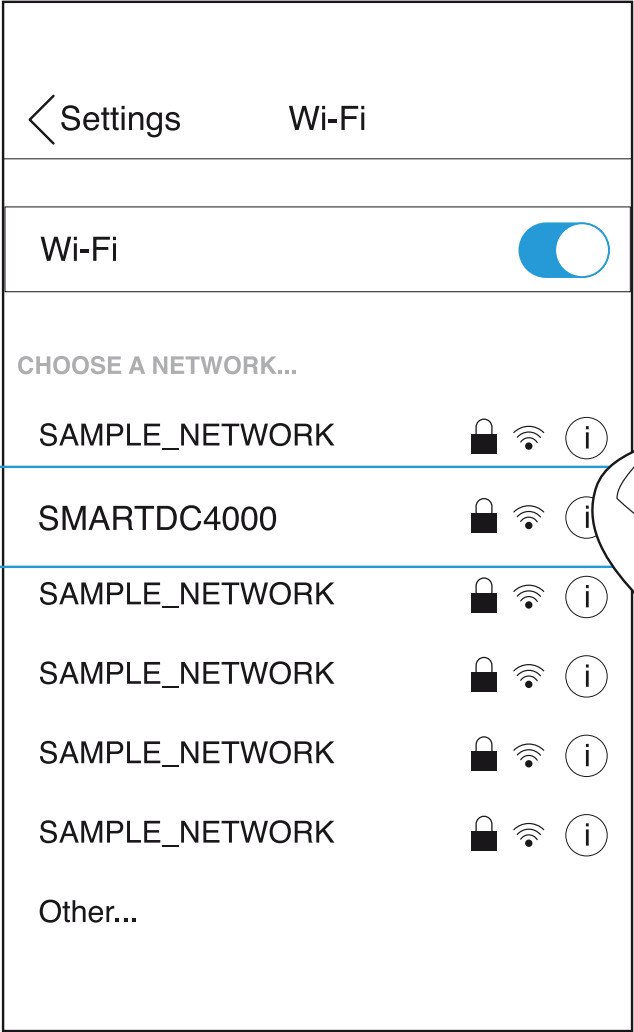
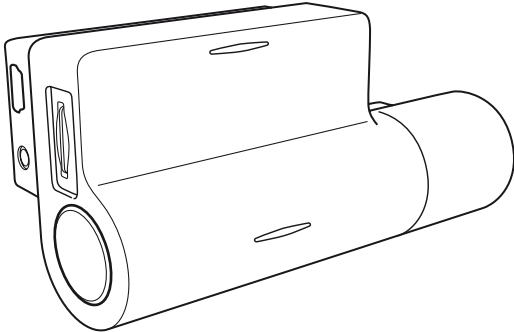

ADJUSTING VIEWING ANGLE



ATTENTION! Adjusting the viewing angle can only be done along the vertical axis, so be sure to position the device correctly on the windshield along the horizontal axis as close as possible to the windshield's center.

While pulling or pushing the device in the holder, ensure that the camera captures the image in proportions of 30% sky / 70% road.

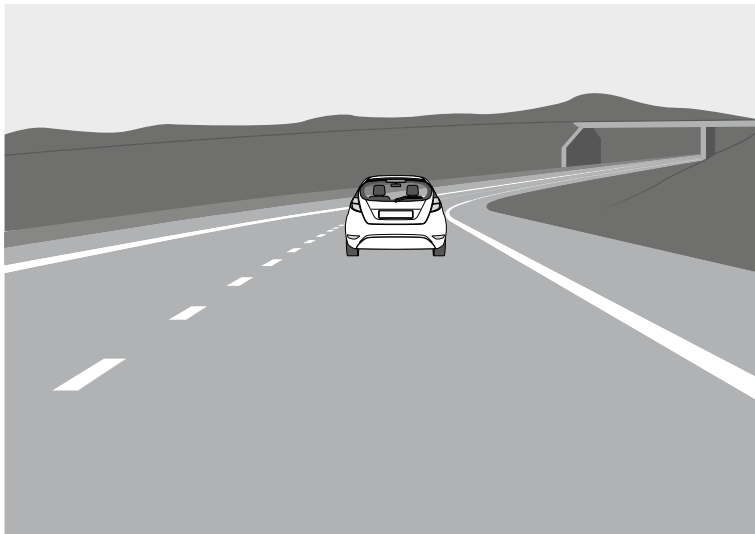

Good

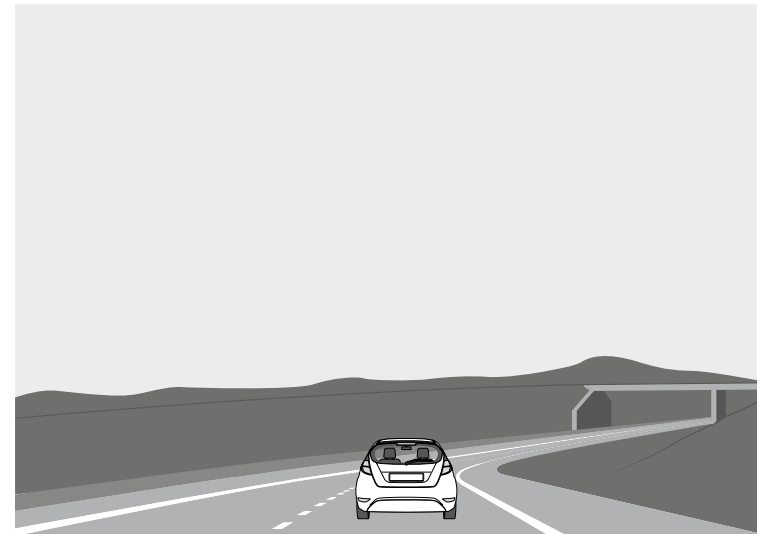

Bad



MENU SETTINGS

To access the Menu settings, press the “Settings” button on the main menu.

Video Quality: Select required option (the highest option provides the optimum viewing performance).

Image Resolution: 1-12 Megapixels

Loop Recording: 1, 3, or 5 minutes

Date Stamp: OFF / ON

Record Audio: OFF / ON

Parking Monitor: OFF / ON

G-sensor: OFF / LOW / MEDIUM / HIGH

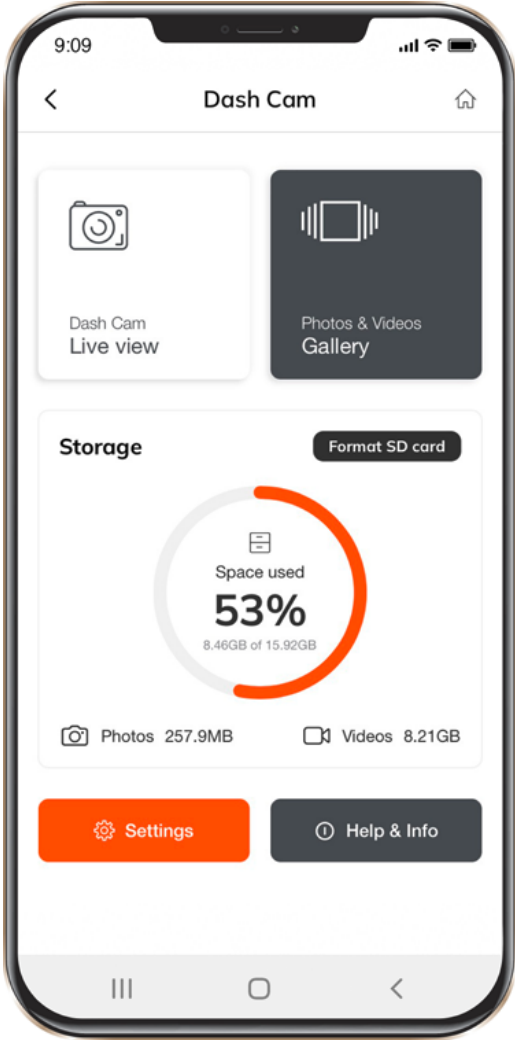



EMERGENCY RECORDING

- 1** Emergency recording is to protect the current video file from being overwritten and deleted.
- 2** Emergency recording is activated automatically when the G-sensor triggers (sudden acceleration/deceleration), or at point of collision. Emergency recording is locked automatically to avoid erasing during loop recording.

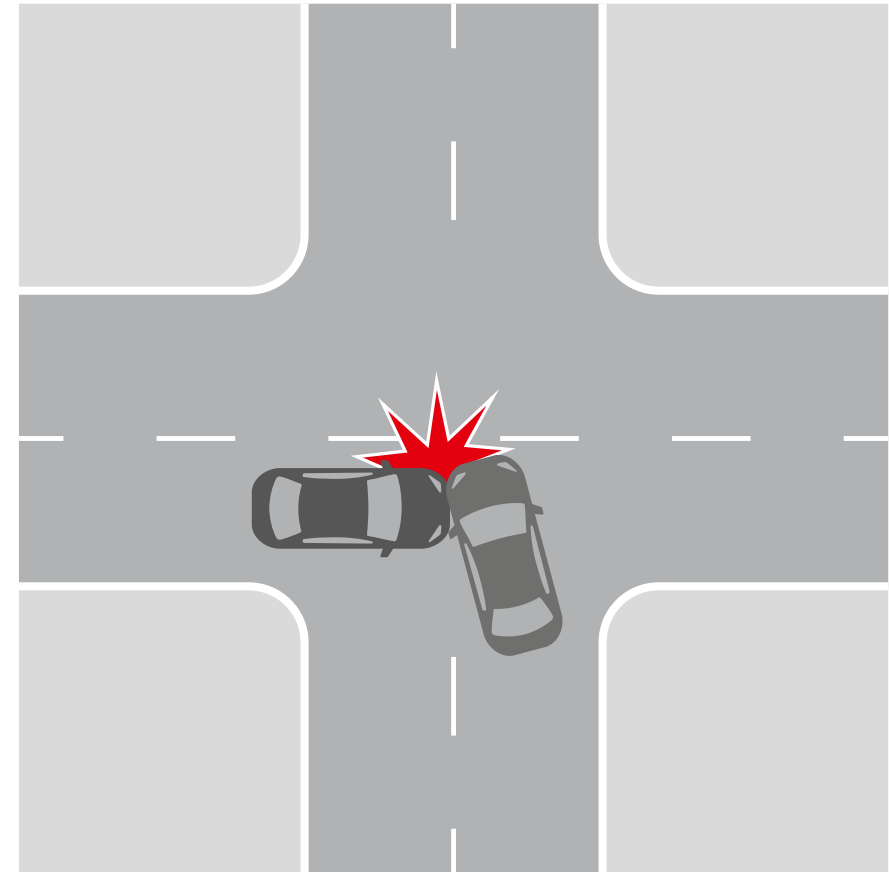

RECORDING PLAYBACK



- 1 To access the playback menu, press the album button on the main screen.
- 2 Video & Image Menu.
 - Select either Videos or Images tiles to view.





VIDEO MENU

- 1 Short-press each video file once to get into the playback menu.
- 2 Press and hold each video file for 3 seconds to access the video's sub-menu. From there, lock, download, share, or delete the selected video.





IMAGE MENU

- 1 Short-press each image file once to get into the playback menu.
- 2 Press and hold each image file for 3 seconds to access the video's sub-menu. From there, lock, download, share, or delete the selected image.

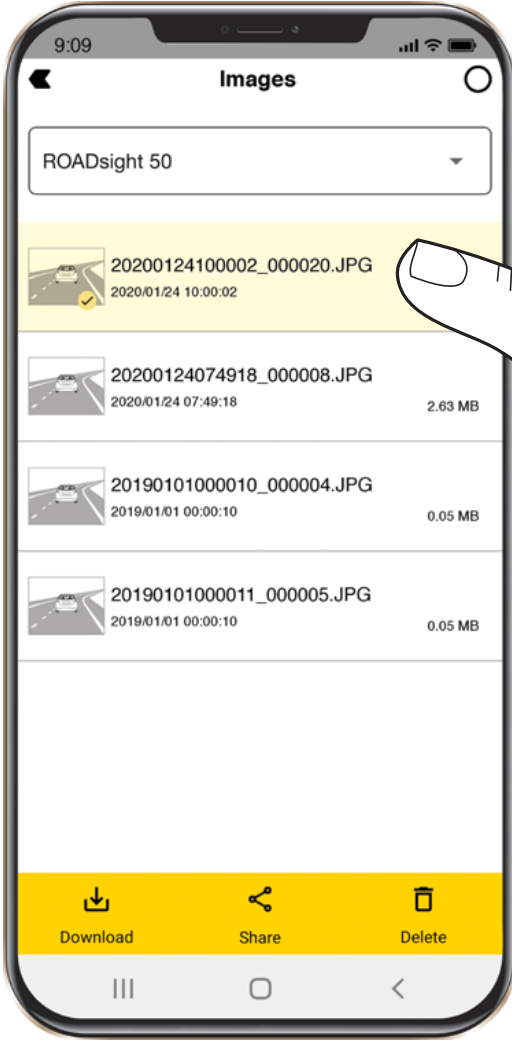



FAQs MENU

To access the FAQs Menu, press the dropdown menu and select FAQs.

Swipe up or down to view all common frequently asked questions.

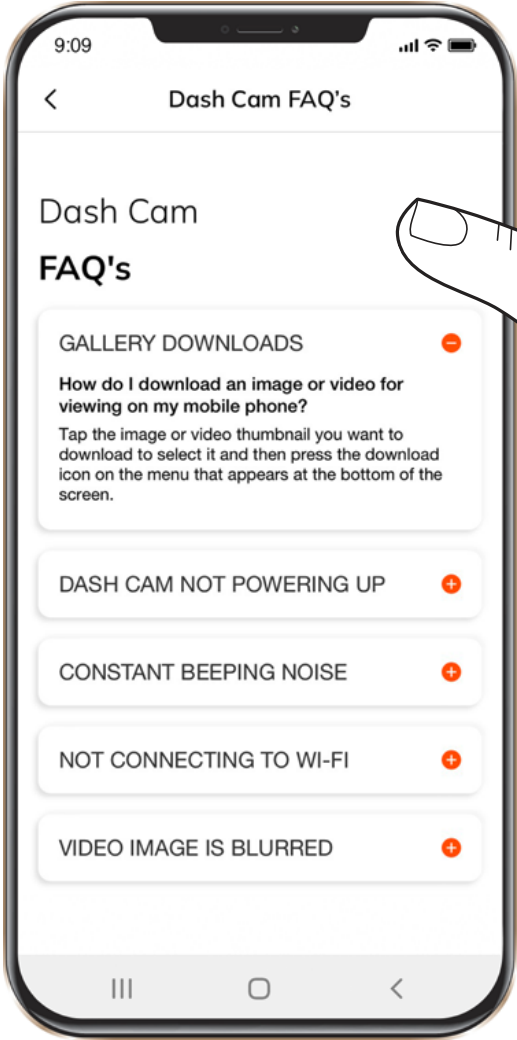

INSTALLATION GUIDE MENU



- 1** To access the Installation Guide Menu, press the dropdown menu and select Installation Guide.
- 2** Another dropdown menu will appear. Select the dashcam being used from the dropdown menu.

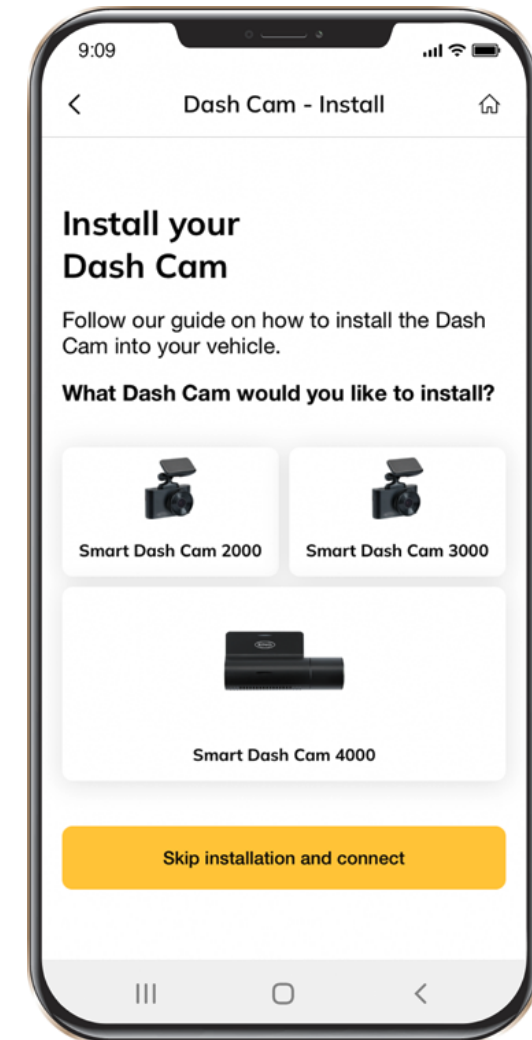

FAILURE TO PHOTOGRAPH / RECORD VIDEO



Check if there is enough free space on the micro SD card.

RECORDING HAS STOPPED

Too many video files stored. Only use at least class 10 U1 high-speed micro SD cards by proven manufacturers.

When you try to view a photo/play a video file, the “wrong file” message appears.

File writing failure due to micro SD card file system error. Format the micro SD card.

BLURRED IMAGE

Ensure removal of lens sticker. Check for dirt on the lens. If there is any, wipe the lens with a soft cloth before use (it is recommended to use special care products for the optics in order not to damage the surface of the lens).



HANG UP (NO IMAGE, NO BUTTON RESPONSE)

Press the RESET button in the App to reboot the device.

















MicroSD Card not recognized when used in Ring Smart Dash Cam 4000 **

Please format card *

- 1** Ensure MicroSD cards is inserted correctly into dashcam
 - 2** Connect dash cam to RINGconnect APP
 - 3** Once dashcam connected to APP select settings 'COG ICON'
 - 4** Select FORMAT option
 - 4** Select YES to FORMAT MicroSD card
- *** Format MicroSD card will delete all information and recordings from the MicroSD card
- **** Dashcam will have a constant beep noise if card is not recognized and needs to be formatted. Please note: If a micro SD card larger than 32GB is used, the latest firmware update is required.

FEATURES



Ring Smart Dash Cam 4000	1440p 	140° 	≤128 GB* 	≤20 HRS* 	Wi-Fi	GPS
Ring Smart Dash Cam 3000	1296p 	130° 	≤64 GB* 	≤12 HRS* 	Wi-Fi	GPS
Ring Smart Dash Cam 2000	1080p 	120° 	≤32 GB* 	≤6 HRS* 	Wi-Fi	
Ring Dash Cam 1000	720p 	110° 	≤32 GB* 	≤3 HRS* 		

* Full HD at 30 FPS.

** Max record time dependent on screen resolution, memory card size, and rear camera attachment.

POWER REQUIREMENTS



ATTENTION! Once there is no external power input, the battery cannot support recording for a long time, please make sure power supply is connected when recording.

Input voltage: 5V DC, 1.5A

Charging input voltage: 12-24V DC

Mini USB Connection for Power

OPERATING TEMPERATURES (all models)

Storage temperature: -20° C to 70° C

Operating temperature: -10° C to 60° C

PLEASE RECYCLE YOUR SPENT BATTERIES



Batteries should not be disposed of in unsorted municipal waste, but separately collected to facilitate the correct treatment and recycling of the substances they contain. The recycling of batteries ensures the recovery of these valuable materials and prevents any potentially harmful effects upon both the environment and human health.



Ring Smart Dash Cam 4000

Dashcam HD 1296p

Deutsch

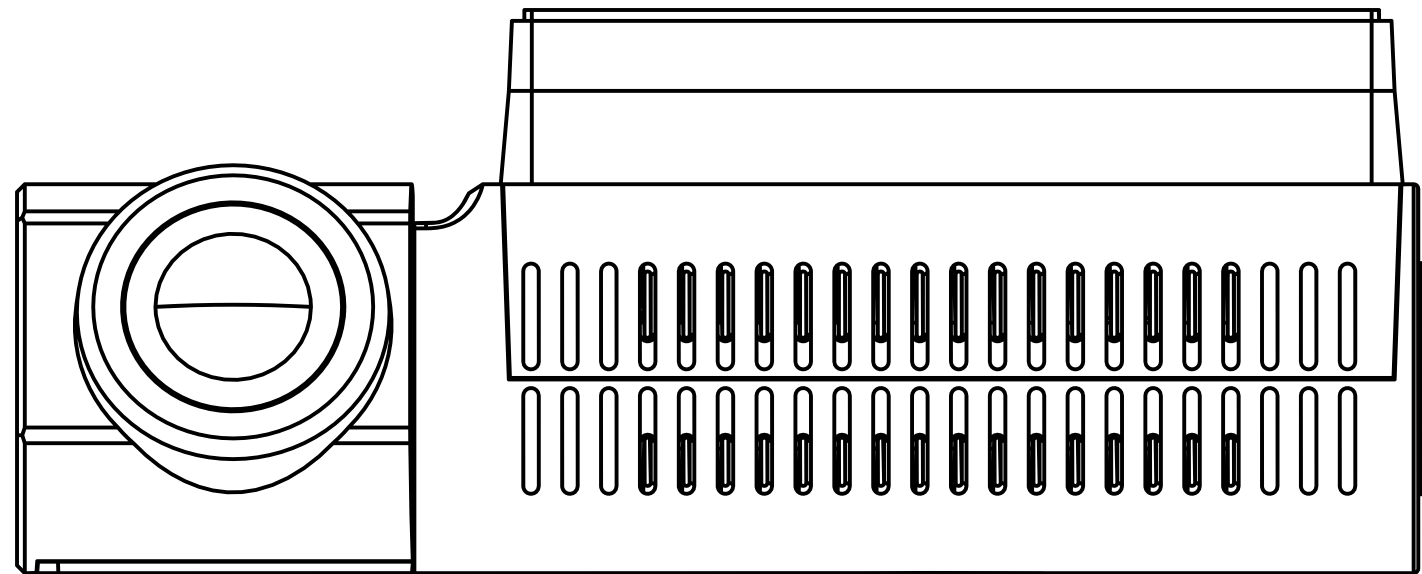

WARNUNG



- 1** Individuelle besondere Anforderungen und Rechtsvorschriften der Länder sind zu beachten, insbesondere hinsichtlich der Dauer der Aufzeichnungen/Verwendung und der Übermittlung von Daten. Bitte machen Sie sich mit den Datenschutzgesetzen Ihres Landes vertraut und stellen Sie sicher, dass Sie diese einhalten. Bitte machen Sie sich auch mit den einschlägigen Gesetzen und Vorschriften in Bezug auf die Verwendung und den Besitz von Dashcams in Ihrem Land vertraut.

DE/AT: Dauerhafte und anlasslose Aufzeichnungen sind nicht erlaubt, d.h. keine Aufzeichnung der gesamten Strecke, der Kennzeichen oder von Fremden (sog. Loop-Funktion). Bei der Aufzeichnung eines Ereignisses, z. B. eines Unfalls, müssen alle Beteiligten über die Aufzeichnung und deren Übermittlung an die Polizei informiert werden. Keine Veröffentlichung von Aufnahmen in öffentlichen Medien (Internet, Social Media) ohne Zustimmung aller betroffenen Personen oder nur nach Unkenntlichmachung der Personen und Nummernschilder. Es muss unmöglich sein, Rückschlüsse auf Personen zu ziehen, z. B. durch Bilder der Umgebung.
- 2** Die Dashcam darf nicht in einer Position montiert werden, die die Sicht des Fahrers auf die Straße verdeckt.
- 3** Verwenden Sie nur das mitgelieferte Netzteil, da sonst die Dashcam beschädigt werden kann. Seien Sie beim Reinigen des Dashcam-Objektivs vorsichtig und verwenden Sie nur einen geeigneten Objektivreiniger und ein weiches Tuch. Setzen Sie dieses Produkt unter keinen Umständen Regen, Feuchtigkeit oder Wasser aus. Andernfalls besteht die Gefahr eines Stromschlags oder eines Brandes. Führen Sie KEINE anderen als die in der Bedienungsanleitung enthaltenen Wartungsarbeiten durch, es sei denn, Sie sind dafür qualifiziert. Platzieren Sie das Gerät bei der Installation in einem Fahrzeug immer sicher an der Windschutzscheibe und verlegen Sie das Netzkabel nach Möglichkeit unter der Innenverkleidung des Fahrzeugs. Stellen Sie sicher, dass das Netzkabel die Bedienelemente des Fahrers wie Lenkrad, Pedale oder Schalthebel nicht beeinträchtigt. Montieren Sie die Dashcam NICHT vor einem Airbag-Auslösebereich oder in einer Position, in der Innenspiegel verdeckt sind. Arbeiten Sie NICHT während der Fahrt und passen Sie die Einstellungen an oder sehen Sie sich die Aufzeichnungen nur an, während Sie nicht fahren.

VOR DEM START

Wenn Sie die App noch nicht heruntergeladen haben, tun Sie dies jetzt, um Ihre Dashcamera optimal zu nutzen.

- 1 Laden Sie die App herunter, indem Sie im App Store (iPhone) oder bei Google Play (Android) nach RING-connect suchen.
- 2 Öffnen Sie die App, folgen Sie dem angezeigten Setup-Vorgang und aktivieren Sie alle erforderlichen Einstellungen, wenn Sie dazu aufgefordert werden.

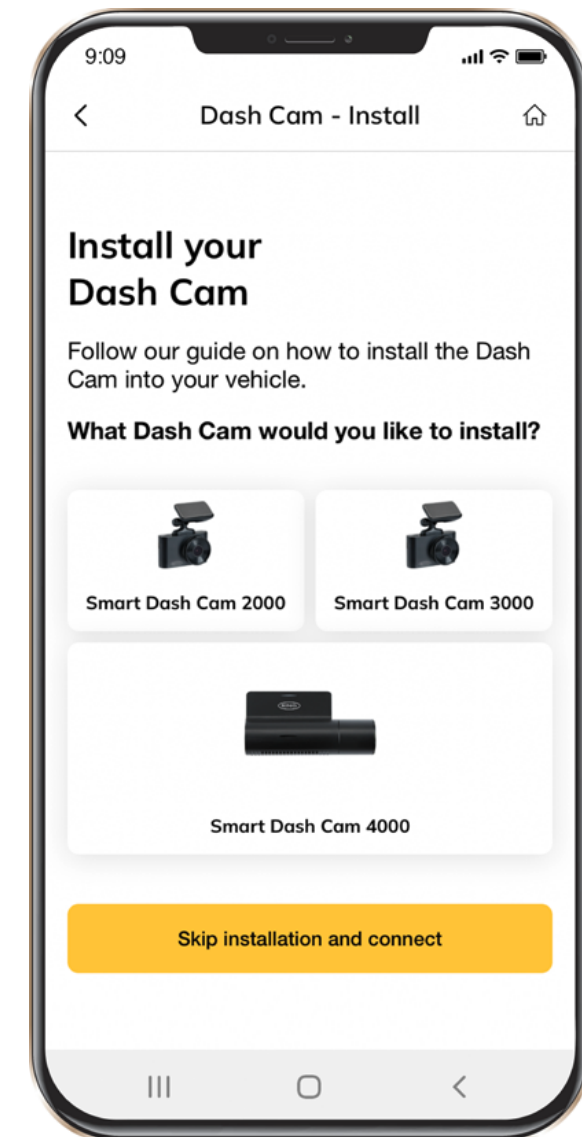



LIEFERUMFANG

- 1 Dashcam
- 2 Kurzanleitung
- 3 Magnethalterung
- 4 USB-Ladekabel
- 5 Trimentfernungswerkzeug
- 6 Fensteraufkleber

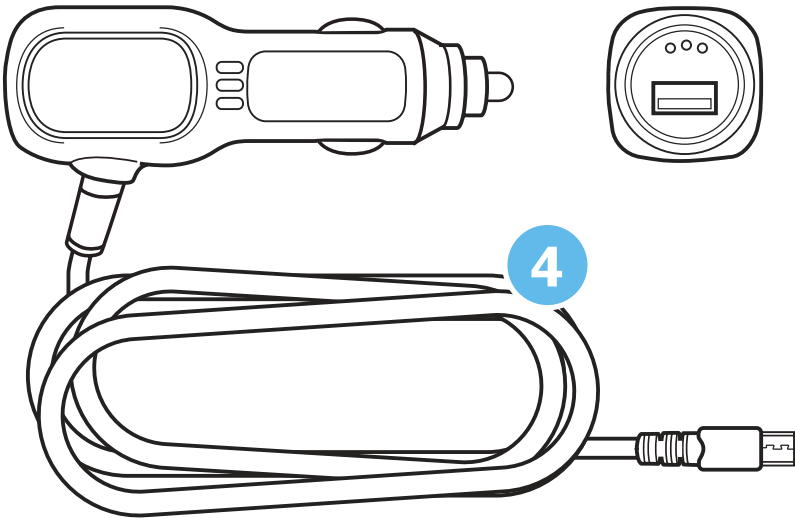
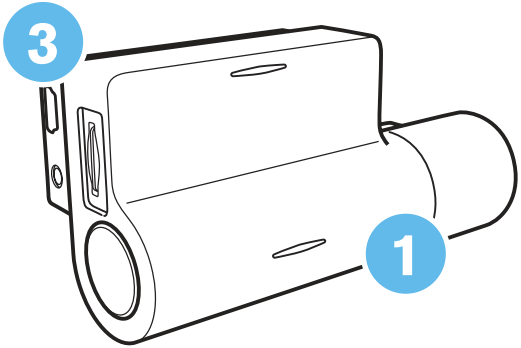
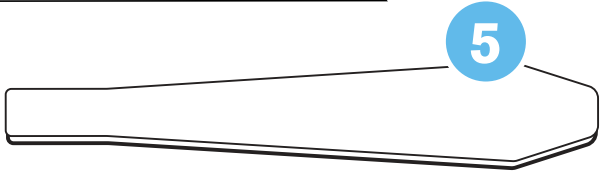
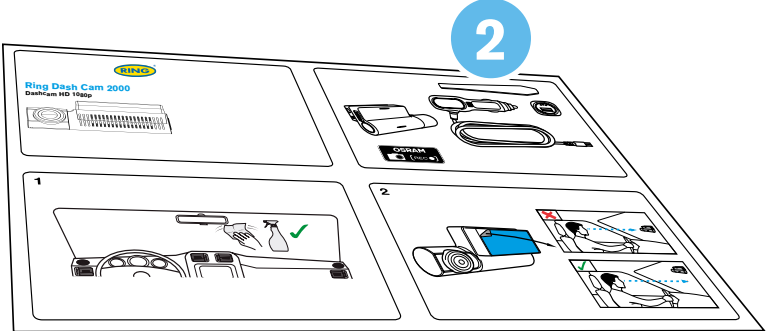



ACHTUNG! Wählen Sie den Installationsort im Voraus, da das Klebeband auf der Halterung zum einmaligen Gebrauch bestimmt ist.

- 1** Stellen Sie sicher, dass das Glas frei von Schmutz, Staub und Fett ist.
- 2** Erwärmen Sie das Klebepadteil der Halterung in den Händen, um eine starke Haftung auf Glas zu gewährleisten.
- 3** Nachdem die Halterung positioniert wurde, schließen Sie die Dashcam an die Magnethalterung an.

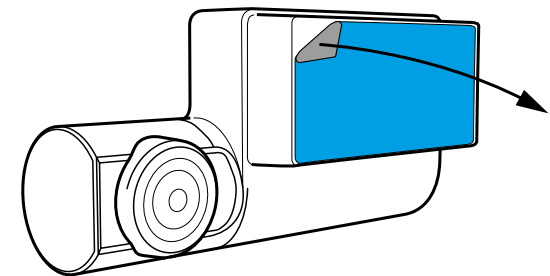
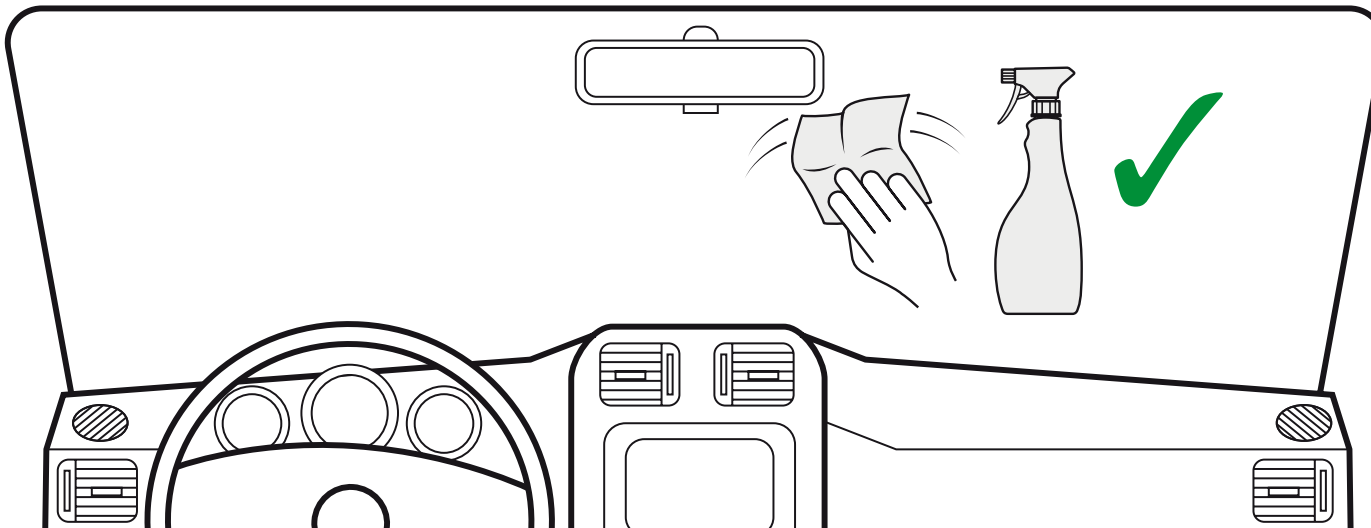



Verwenden Sie zum Einschalten des Geräts und zum Laden des Akkus nur das mitgelieferte Netzteil. Schließen Sie das Netzkabel an die Halterung an und stecken Sie das USB-Ladegerät in die 12-V-Steckdose des Fahrzeugs.

Wenn der Motor des Fahrzeugs startet, schaltet sich das Gerät automatisch ein.

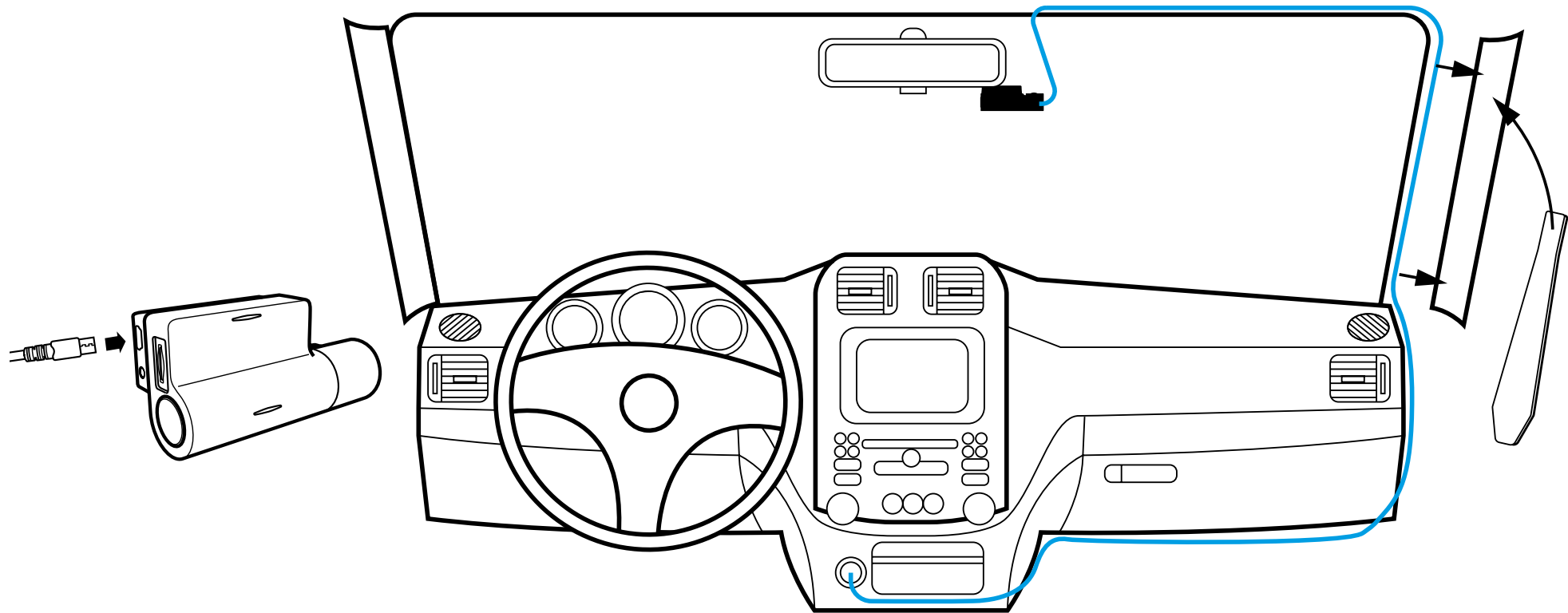

microSD-KARTE INSTALLIEREN



- 1** Stellen Sie vor der Installation einer Speicherkarte sicher, dass das Gerät ausgeschaltet ist.
- 2** Setzen Sie die Speicherkarte ein, bis sie einrastet.
- 3** Entfernen einer Karte: Drücken Sie leicht auf die Karte und entfernen Sie sie dann aus dem Steckplatz.

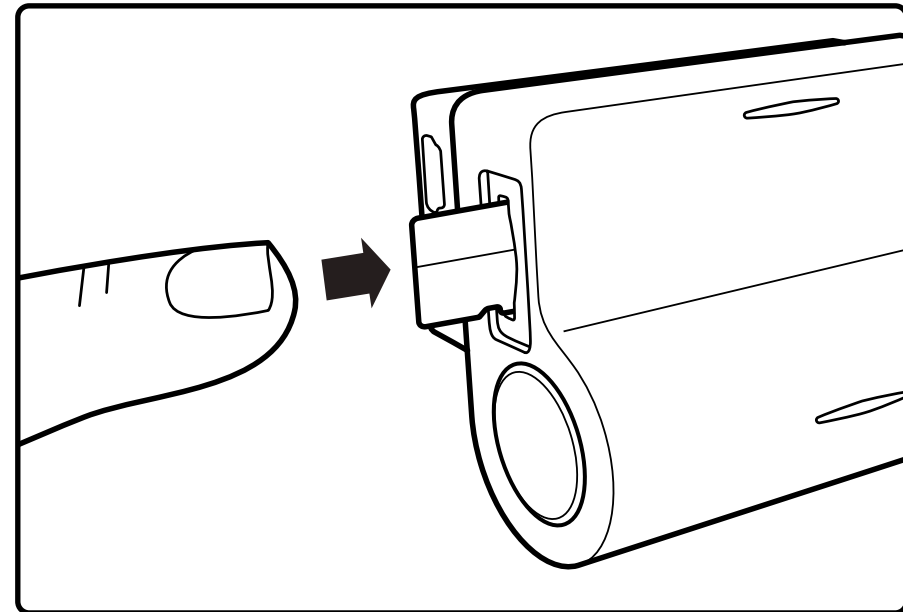

WARNUNG! Wenden Sie beim Einsetzen einer Speicherkarte keine übermäßige Kraft an, um Schäden am Gerät zu vermeiden. Verwenden Sie gegebenenfalls ein dünnes, spitzes Gerät, um die Karte weiter zu schieben. Um die Speicherkarte zu entfernen, drücken Sie auf die Karte, bis sie einrastet, und entfernen Sie die Karte aus dem Steckplatz.

EIN / AUS



- Wenn die Fahrzeugzündung eingeschaltet ist, schaltet sich die Dashcam automatisch ein.
- Um das Gerät manuell einzuschalten, drücken Sie den Netzschalter.
- Um das Gerät auszuschalten, halten Sie den Netzschalter ca. 3 Sekunden.

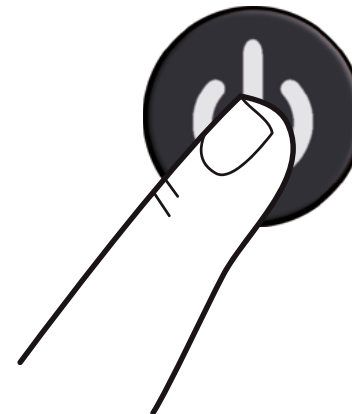
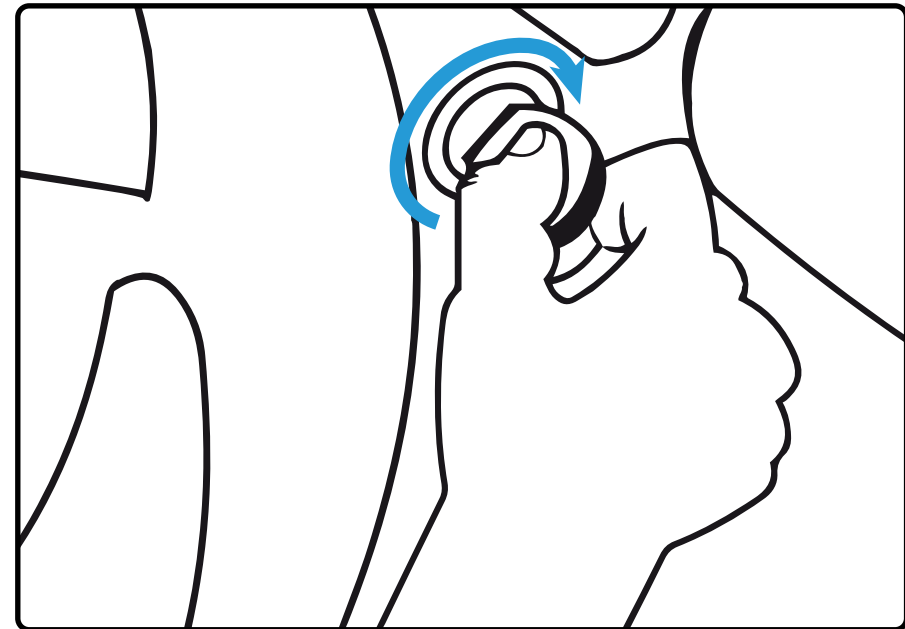

ANSCHLUSS AN MOBIL



- 1 Schalten Sie die Dashcam ein.
- 2 Ihre Kamera sendet automatisch ein WLAN-Netzwerk.
- 3 Öffnen Sie die Einstellungen Ihres Telefons.
- 4 Tippen Sie auf Wi-Fi-Verbindungen.
- 5 Wählen Sie den Dashcamhotspot aus und geben Sie das Passwort „12345678“ ein.
- 6 Sie sind jetzt mit Ihrem Gerät verbunden.

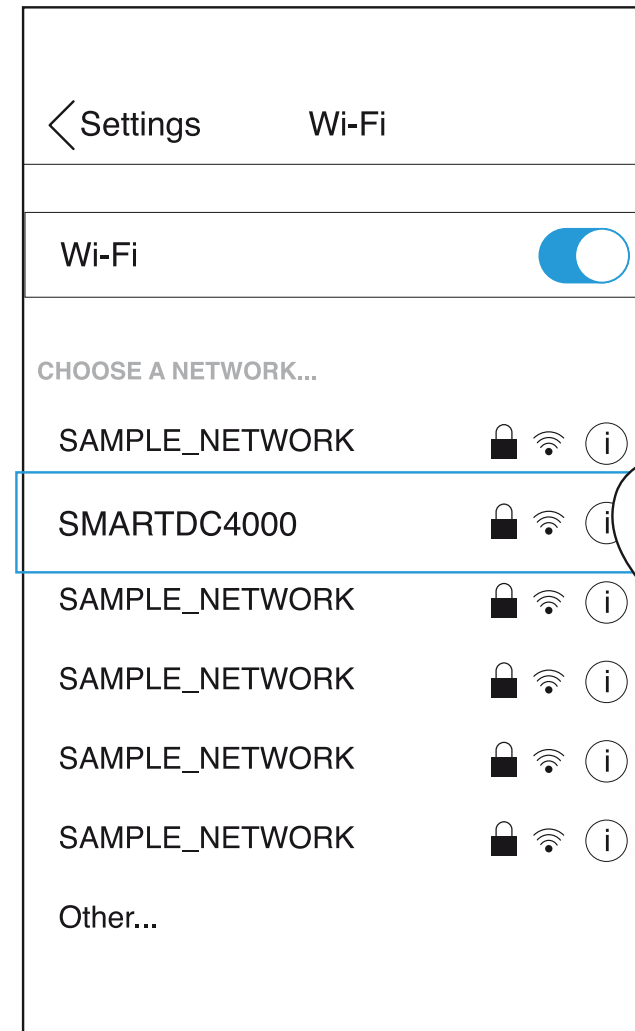
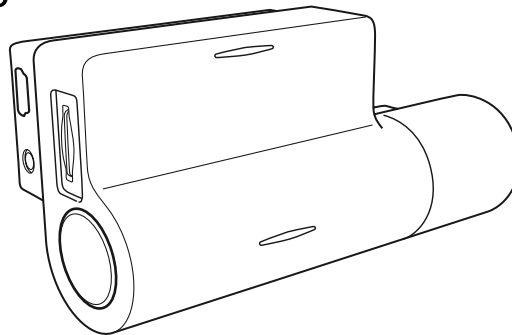

EINSTELLEN DES BETRACHTUNGSWINKELS



ACHTUNG! Die Einstellung des Betrachtungswinkels kann nur entlang der vertikalen Achse erfolgen. Achten Sie daher darauf, dass Sie das Gerät entlang der horizontalen Achse so nah wie möglich an der Mitte der Windschutzscheibe positionieren.

Stellen Sie beim Ziehen oder Drücken des Geräts in der Halterung sicher, dass die Kamera das Bild in Proportionen von 30 % Himmel / 70 % Straße aufnimmt.

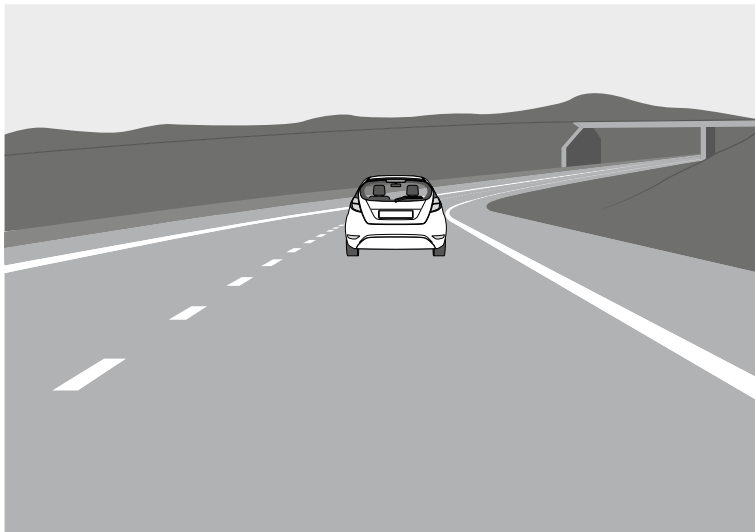

Gut

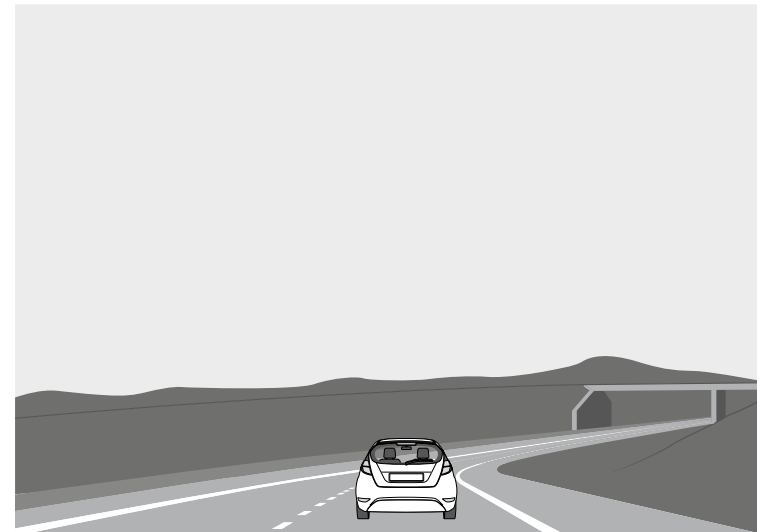

Schlecht

MENÜ EINSTELLUNGEN

Um auf die Menüeinstellungen zuzugreifen, klicken Sie im Hauptmenü auf die Schaltfläche „Einstellungen“.

Videoauflösung: Wählen Sie die gewünschte Option aus (die höchste Option bietet die optimale Anzeigeleistung).

Bildauflösung: 1-12 Megapixel

Loop-Aufnahme: 3 oder 5 Minuten

Datumsstempel: AUS / EIN

Audio aufnehmen: AUS/EIN

Parkmonitor: AUS / EIN

G-Sensor:
AUS/NIEDRIG/MITTEL/HOCH

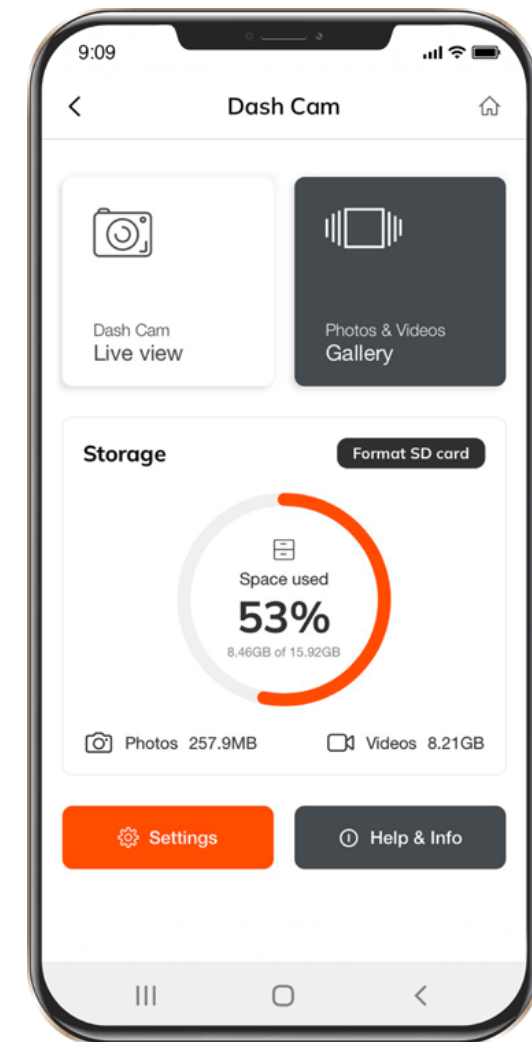

NOTFALLAUFNAHME

- 1** Die Notfallaufnahme soll die aktuelle Videodatei vor dem Überschreiben und Löschen schützen.
- 2** Die Notfallaufzeichnung wird automatisch aktiviert, wenn der G-Sensor auslöst (plötzliche Beschleunigung / Verzögerung) oder an einem Kollisionspunkt. Die Notfallaufzeichnung wird automatisch gesperrt, um ein Löschen während der Schleifenaufzeichnung zu vermeiden.

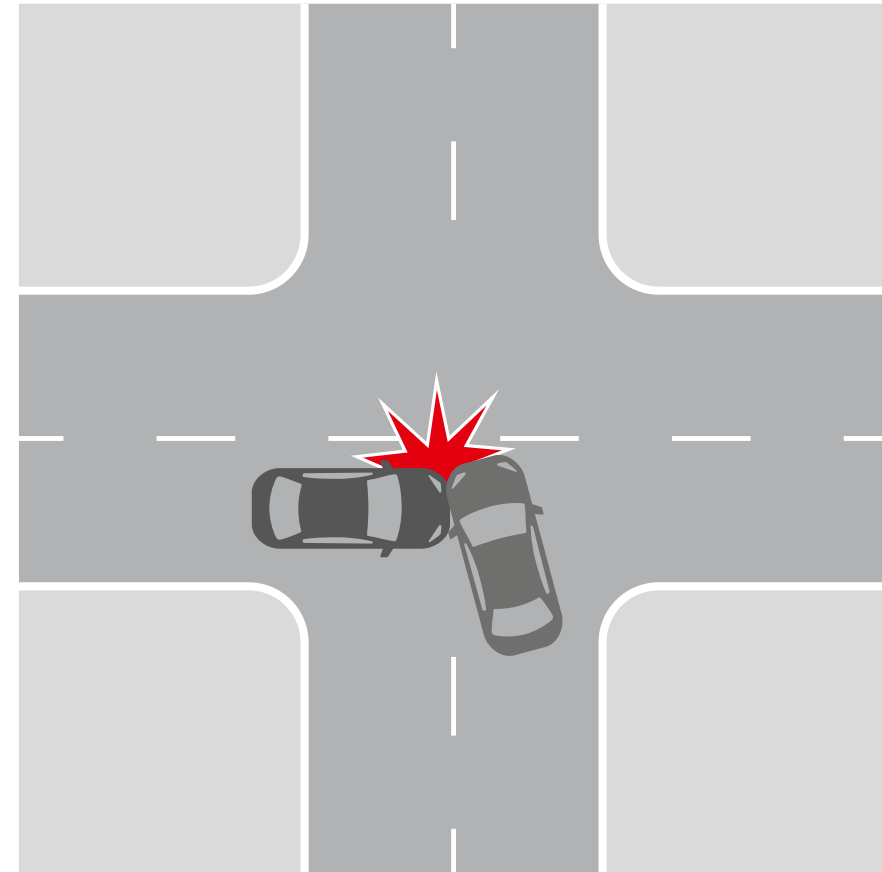

AUFNAHME UND WIEDERGABE



- 1 Um auf das Wiedergabemenü zuzugreifen, drücken Sie die Albumtaste auf dem Hauptbildschirm.
- 2 Video- und Bildmenü.
 - Wählen Sie entweder Videos oder Bilder aus, um sie anzuzeigen.



SO VERWENDEN SIE DAS VIDEO-MENÜ



- 1 Drücken Sie einmal kurz auf jede Videodatei, um zum Wiedergabemenü zu gelangen.
- 2 Halten Sie jede Videodatei 3 Sekunden lang gedrückt, um auf das Untermenü des Videos zuzugreifen. Von dort aus können Sie das ausgewählte Video sperren, herunterladen, freigeben oder löschen.





BILD DES MENÜS

- 1 Drücken Sie einmal kurz auf jede Videodatei, um zum Wiedergabemenü zu gelangen.
- 2 Halten Sie jede Videodatei 3 Sekunden lang gedrückt, um auf das Untermenü des Videos zuzugreifen. Von dort aus können Sie das ausgewählte Video sperren, herunterladen, freigeben oder löschen.



FAQs MENÜ

Um auf das FAQ-Menü zuzugreifen, drücken Sie auf das Dropdown-Menü und wählen Sie FAQs.

Wischen Sie nach oben oder unten, um alle häufig gestellten Fragen anzuzeigen.

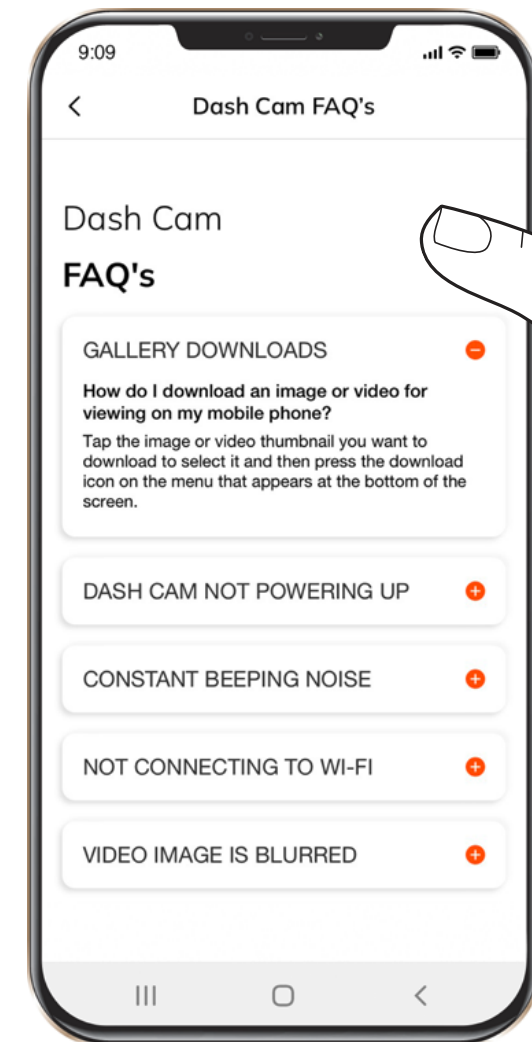

INSTALLATIONSANLEITUNG



- 1** Um auf das Installationshandbuch-Menü zuzugreifen, drücken Sie auf das Dropdown-Menü und wählen Sie Installationshandbuch.
- 2** Ein weiteres Dropdown-Menü wird angezeigt. Wählen Sie die verwendete Dashcam aus dem Dropdown-Menü.

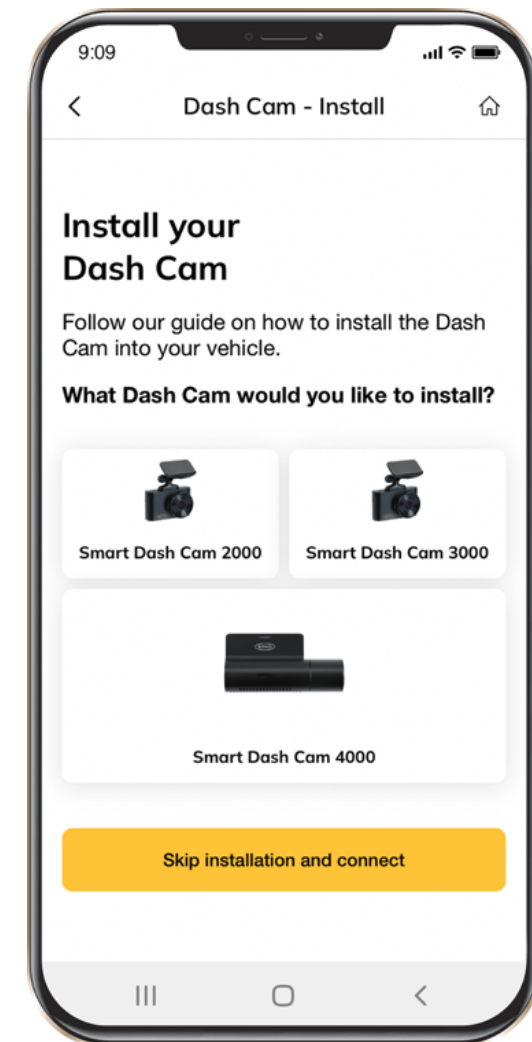

FEHLER BEI FOTOGRAFIE/VIDEOAUFNAHME



Überprüfen Sie, ob auf der Micro-SD-Karte genügend freier Speicherplatz vorhanden ist.

DIE AUFNAHME WURDE GESTOPPT

Zu viele Videodateien gespeichert. Verwenden Sie mindestens U1-Hochgeschwindigkeits-Micro-SD-Karten der Klasse 10 von bewährten Herstellern.

Wenn Sie versuchen, ein Foto anzuzeigen / eine Videodatei abzuspielen, wird die Meldung "Falsche Datei" angezeigt.

Fehler beim Schreiben der Datei aufgrund eines Systemfehlers der Micro-SD-Kartendatei. Zum Formatieren der Micro-SD-Karte:

BILD UNSCHARF

Stellen Sie sicher, dass der Objektivaufkleber entfernt wird. Überprüfen Sie das Objektiv auf Schmutz. Wenn vorhanden, wischen Sie das Objektiv vor dem Gebrauch mit einem weichen Tuch ab (es wird empfohlen, spezielle Pflegeprodukte für die Optik zu verwenden, um die Oberfläche des Objektivs nicht zu beschädigen).

AUFGEHÄNGT (KEIN BILD, KEINE TASTENANTWORT)



Drücken Sie die RESET-Taste, um das Gerät neu zu starten.

MicroSD-Karte wird bei Verwendung in der Ring Smart Dash Cam 4000 ** nicht erkannt

Bitte Karte formatieren *

















- 1** Stellen Sie sicher, dass die MicroSD-Karten korrekt in die Dashcam eingesetzt sind
- 2** Verbinden Sie die Dash Cam mit der RINGconnect APP
- 3** Sobald die Dashcam mit der APP verbunden ist, wählen Sie die Einstellungen 'COG ICON'.
- 4** Wählen Sie die Option FORMAT
- 5** Wählen Sie JA, um die MicroSD-Karte zu formatieren

* Format MicroSD-Karte löscht alle Informationen und Aufzeichnungen von der MicroSD-Karte

** Die Dashcam gibt ein konstantes Pieptongeräusch aus, wenn die Karte nicht erkannt wird und formatiert werden muss. Bitte beachten Sie: Wenn eine Micro-SD-Karte mit mehr als 32 GB verwendet wird, ist das neueste Firmware-Update erforderlich.

FUNKTIONEN



Ring Smart Dash Cam 4000	1440p 	140° 	≤128 GB* 	≤20 HRS* 	Wi-Fi	GPS
Ring Smart Dash Cam 3000	1296p 	130° 	≤64 GB* 	≤12 HRS* 	Wi-Fi	GPS
Ring Smart Dash Cam 2000	1080p 	120° 	≤32 GB* 	≤6 HRS* 	Wi-Fi	
Ring Dash Cam 1000	720p 	110° 	≤32 GB* 	≤3 HRS* 		

* Full HD bei 30 FPS.

** Maximale Aufnahmezeit abhängig von Bildschirmauflösung, Speicherkartengröße und rückseitigem Kameraaufsatz.

ANFORDERUNGEN AN DAS STROMNETZ



ACHTUNG! Wenn kein externer Stromeingang vorhanden ist, kann der Akku die Aufnahme für längere Zeit nicht unterstützen. Stellen Sie bitte sicher, dass die Stromversorgung bei der Aufnahme angeschlossen ist.

Eingangsspannung: 5 V DC, 1,5 A.

Ladeeingangsspannung: 12-24V DC

Mini-USB-Anschluss für die Stromversorgung

BETRIEBSTEMPERATUREN (alle Modelle)

Lagertemperatur: -20 °C bis 70 °C.

Betriebstemperatur: -10 °C bis 60 °C.



BITTE RECYCELN SIE IHRE VERBRAUCHTEN BATTERIEN

Batterien sollten nicht im unsortierten Siedlungsabfall entsorgt, sondern separat gesammelt werden, um die korrekte Behandlung und das Recycling der enthaltenen Stoffe zu ermöglichen. Das Recycling von Batterien gewährleistet die Rückgewinnung dieser wertvollen Materialien und verhindert potenziell schädliche Auswirkungen auf die Umwelt und die menschliche Gesundheit.



Ring Smart Dash Cam 4000

Dashcam HD 1296p

Français

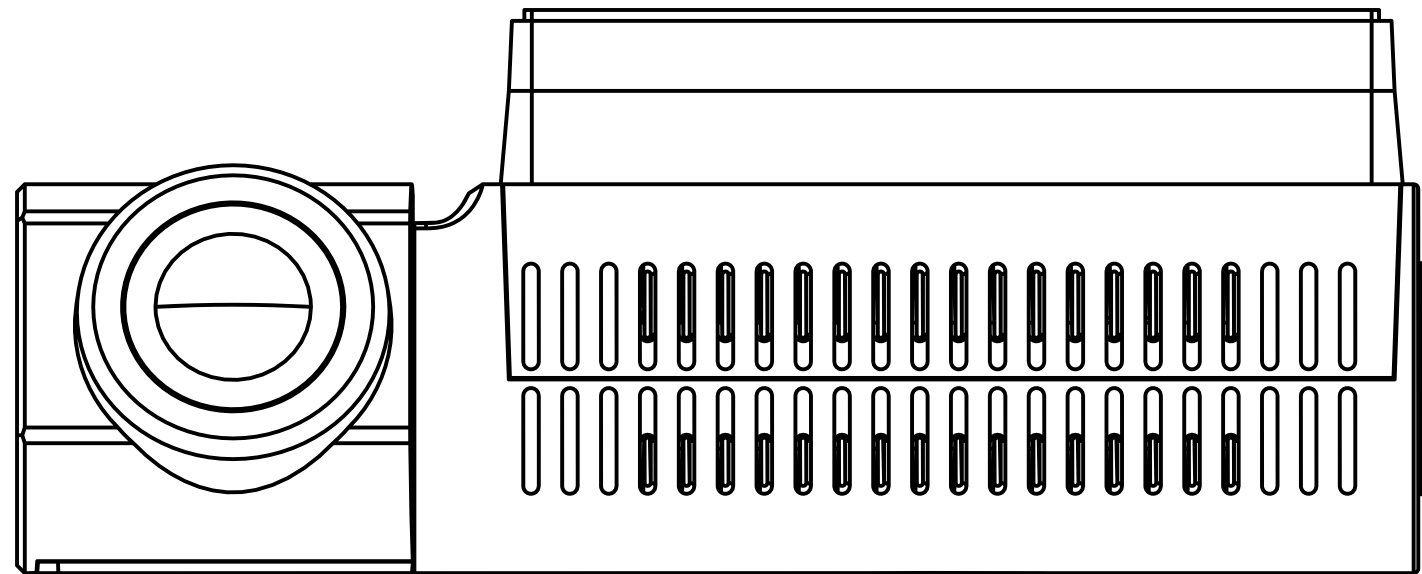



MISE EN GARDE

- 1** Les exigences et la législation particulières individuelles des pays doivent être respectées, notamment en ce qui concerne la durée des enregistrements/l'utilisation et le transfert des données. Veuillez vous familiariser avec les lois sur la protection des données de votre pays et assurez-vous de les respecter. Veuillez également vous familiariser et vous conformer aux lois et réglementations en vigueur concernant l'utilisation et la propriété des caméras de tableau de bord dans votre pays.

DE/AT : les enregistrements permanents et sans occasion ne sont pas autorisés, c'est-à-dire aucun enregistrement d'itinéraire complet, de plaques d'immatriculation ou d'étrangers (fonction dite de boucle). Lors de l'enregistrement d'un événement, par ex. un accident, toutes les parties concernées doivent être informées de l'enregistrement et de son transfert à la police. Pas de publication d'enregistrements dans les médias publics (Internet, médias sociaux) sans le consentement de toutes les personnes concernées ou seulement après avoir déguisé les personnes et les plaques d'immatriculation. Il doit être impossible de tirer des conclusions sur des personnes, par ex. à travers des images de l'environnement.

- 2** La caméra de bord ne doit pas être installée dans une position qui masque la vue du conducteur sur la route devant lui.

- 3** N'utilisez que l'adaptateur secteur fourni, sinon la caméra de bord pourrait être endommagée. Faites attention lorsque vous nettoyez la lentille de la caméra de bord et utilisez uniquement un nettoyant pour lentille approprié et un chiffon doux. N'exposez PAS ce produit à la pluie, à l'humidité ou à l'eau en aucune circonstance ; cela pourrait entraîner un risque d'électrocution ou d'incendie. N'effectuez PAS de maintenance autre que celle contenue dans le manuel d'instructions, sauf si vous êtes qualifié pour le faire. Lorsque vous l'installez dans un véhicule, placez toujours l'appareil en position sûre contre le pare-brise et, dans la mesure du possible, cachez le câble d'alimentation sous la garniture intérieure du véhicule. Assurez-vous que le câble d'alimentation n'interfère pas avec les commandes du conducteur telles que le volant, les pédales ou le levier de vitesses. N'installez PAS la caméra de bord devant une zone de déploiement d'airbag ou dans une position pour masquer les rétroviseurs intérieurs. N'utilisez PAS en conduisant et ajustez les paramètres ou consultez les enregistrements uniquement lorsque vous ne conduisez pas.

AVANT DE COMMENCER

Si vous n'avez pas encore téléchargé l'application, faites-le maintenant pour tirer le meilleur parti de votre caméra de bord.

- 1 Téléchargez l'application en recherchant RINGconnect dans l'App Store (iPhone) ou Google Play (Android).
- 2 Ouvrez l'application, suivez le processus de configuration indiqué et activez tous les paramètres nécessaires lorsque vous y êtes invité.

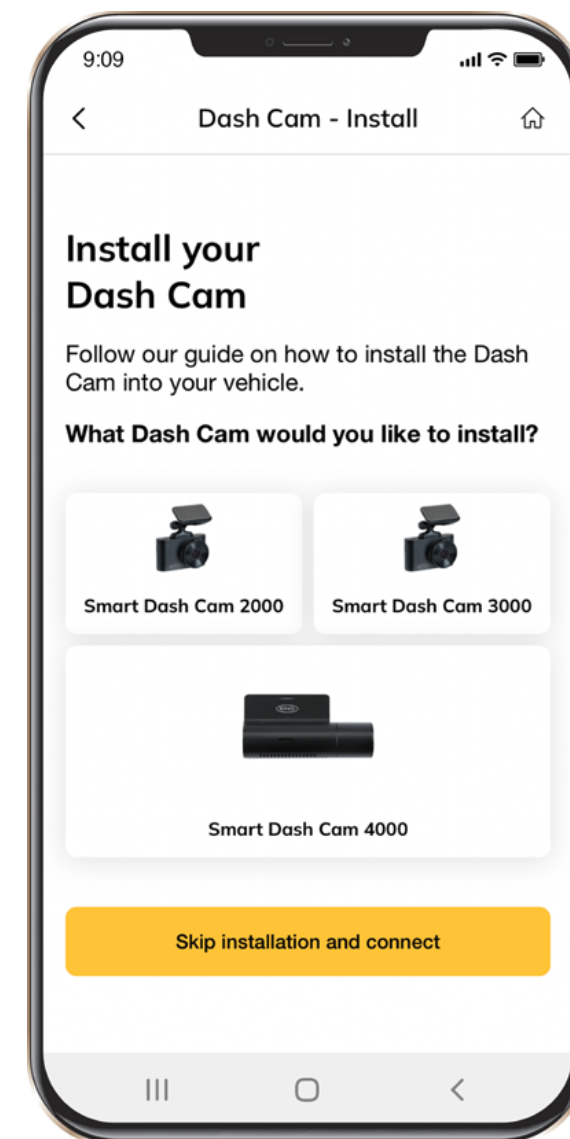



CONTENU DE L'EMBALLAGE

- 1 Caméra de bord
- 2 Guide de démarrage rapide
- 3 Fixation magnétique
- 4 Câble de chargement USB
- 5 Outil de retrait de garniture
- 6 Autocollant de fenêtre

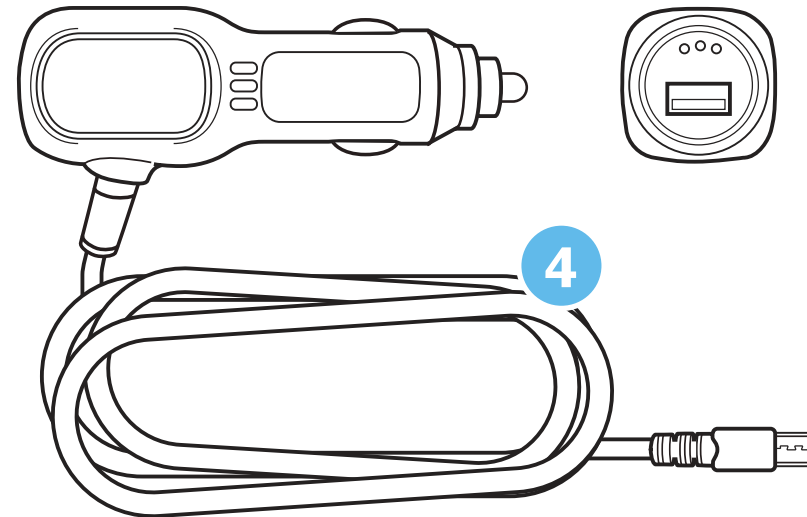
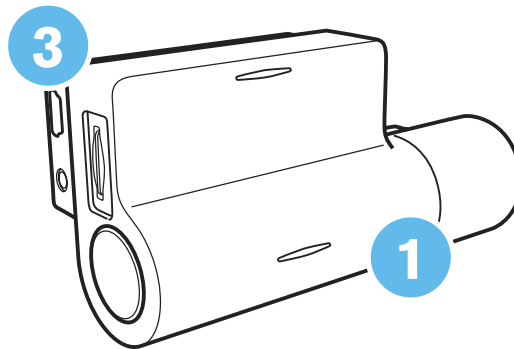
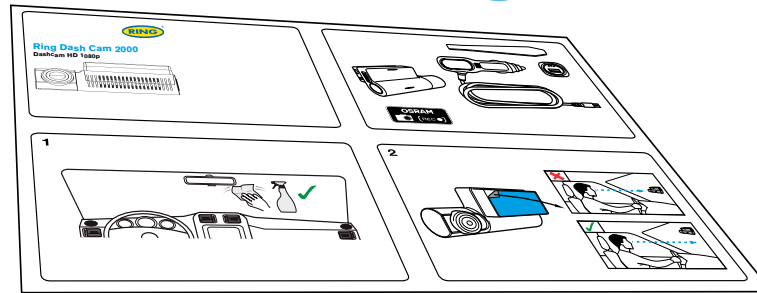



ATTENTION ! Choisissez à l'avance l'emplacement d'installation, car le ruban adhésif sur la fixation est à usage unique.



- 1** Assurez-vous que le verre est exempt de saleté, de poussière et de graisse.
- 2** Chauffez la partie du tampon adhésif de la fixation dans les mains pour assurer une forte adhérence au verre.
- 3** Une fois la fixation positionnée, connectez la caméra de bord à la fixation magnétique.

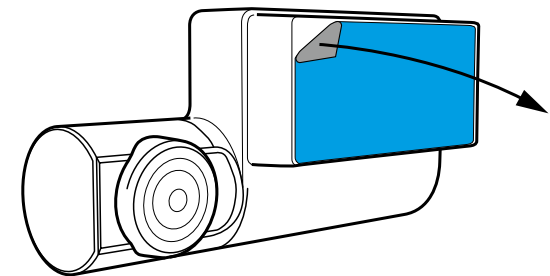
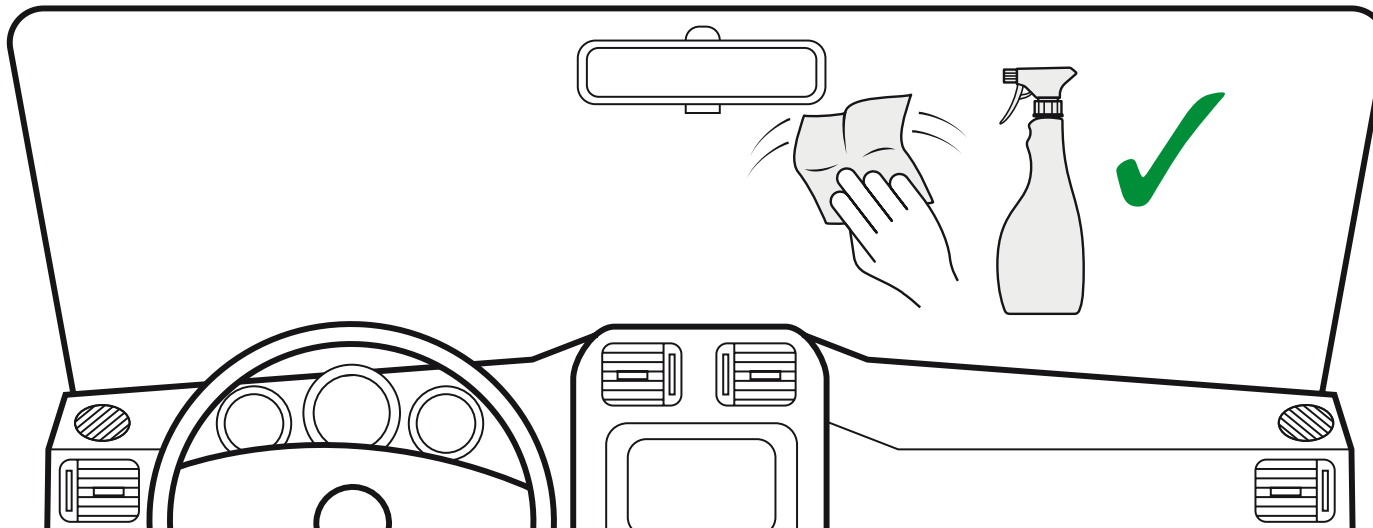



Pour alimenter l'appareil et charger la batterie, utilisez uniquement l'adaptateur secteur inclus. Connectez le câble d'alimentation à la fixation, puis branchez le chargeur USB dans la prise d'alimentation 12 V du véhicule.

Lorsque le moteur du véhicule démarre, l'appareil s'allume automatiquement.

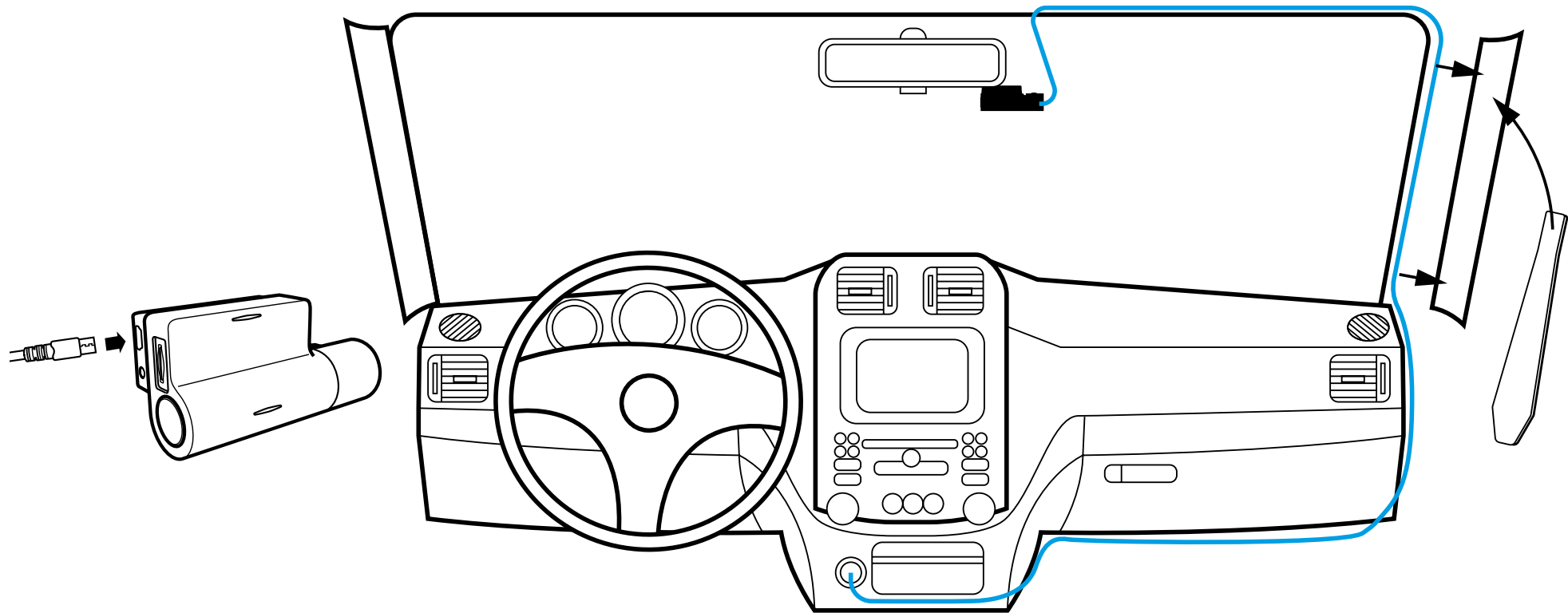

INSTALLATION DE LA CARTE microSD



- 1** Avant d'installer une carte mémoire, assurez-vous que l'appareil est éteint.
- 2** Insérez la carte mémoire jusqu'à ce qu'elle s'enclenche.
- 3** Retrait d'une carte : appuyez légèrement sur la carte, puis retirez-la de son emplacement.

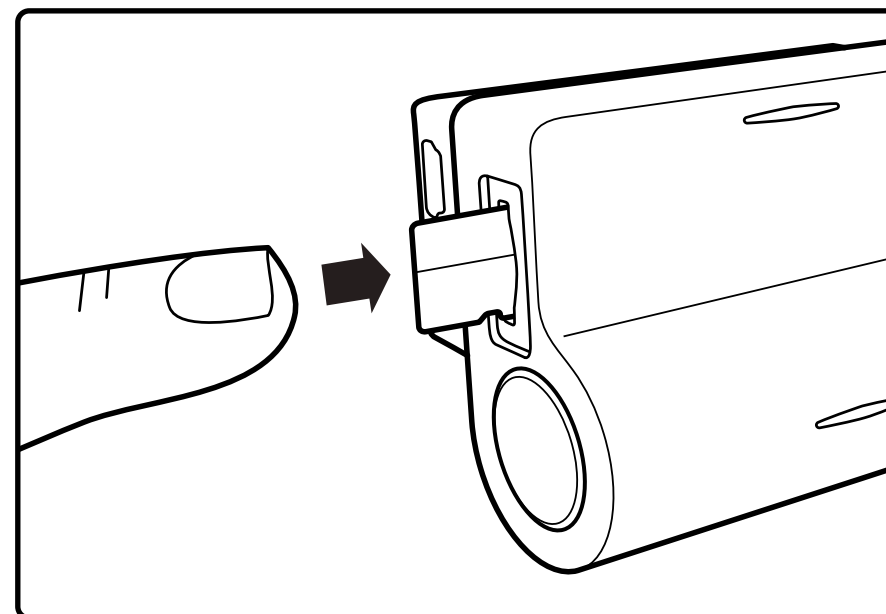

AVERTISSEMENT ! N'appliquez pas de force excessive lors de l'insertion d'une carte mémoire pour éviter d'endommager l'appareil. Si nécessaire, utilisez un appareil fin et pointu pour pousser la carte plus loin. Pour retirer la carte mémoire, poussez la carte jusqu'à ce qu'elle s'enclenche et retirez la carte de son emplacement.

ALLUMER / ÉTEINDRE



- Lorsque le contact du véhicule est mis sur ON, la caméra de bord s'allume automatiquement.
- Pour allumer l'appareil manuellement, appuyez sur le bouton d'alimentation.
- Pour éteindre l'appareil, maintenez le bouton d'alimentation enfoncé pendant env. 3 secondes.

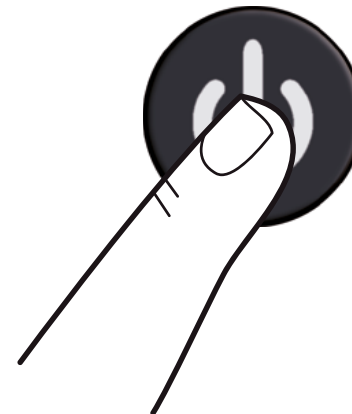
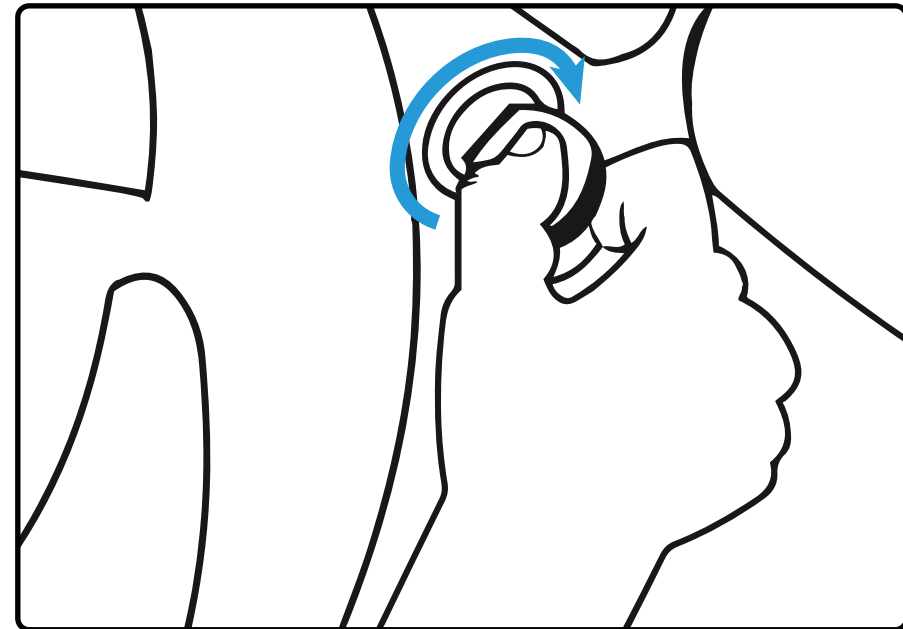

CONNEXION AU TÉLÉPHONE PORTABLE



- 1 Allumez la caméra de bord.
- 2 Votre caméra diffuse automatiquement un réseau Wi-Fi.
- 3 Ouvrez les paramètres de votre téléphone.
- 4 Appuyez sur Wi-Fi ou connexions.
- 5 Sélectionnez le hotspot de la caméra de bord et entrez le mot de passe « 12345678 ».
- 6 Vous êtes maintenant connecté à votre appareil.

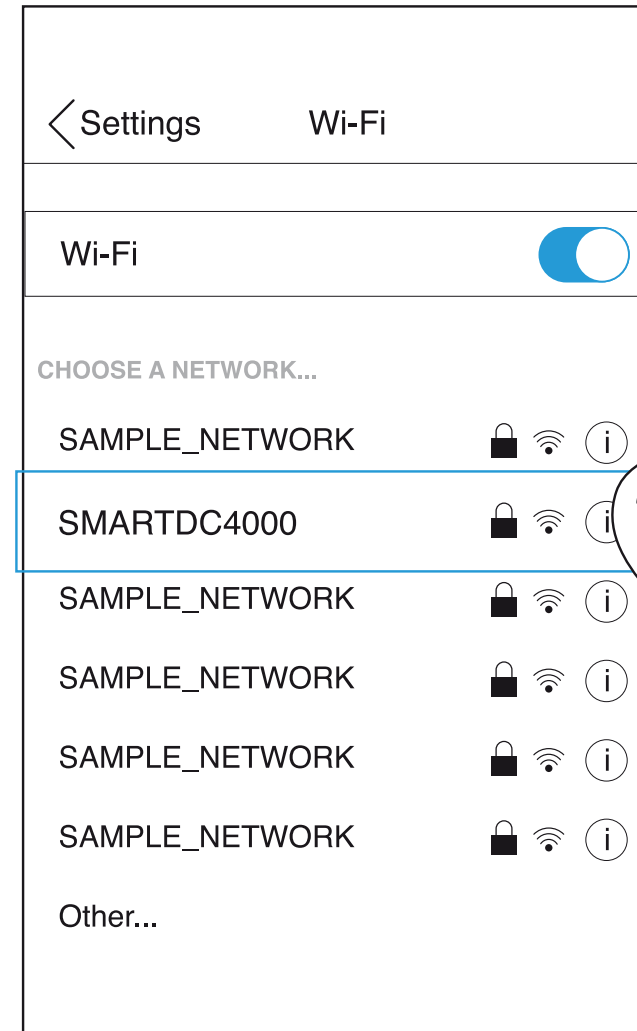
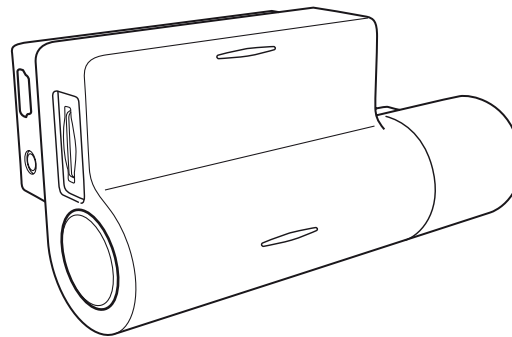

RÉGLAGE DE L'ANGLE DE VUE



ATTENTION ! Le réglage de l'angle de vue ne peut être effectué que le long de l'axe vertical, assurez-vous donc de positionner correctement l'appareil sur le pare-brise le long de l'axe horizontal aussi près que possible du centre du pare-brise.

Tout en tirant ou en poussant l'appareil dans le support, assurez-vous que la caméra capture l'image dans des proportions de 30 % ciel / 70 % route.

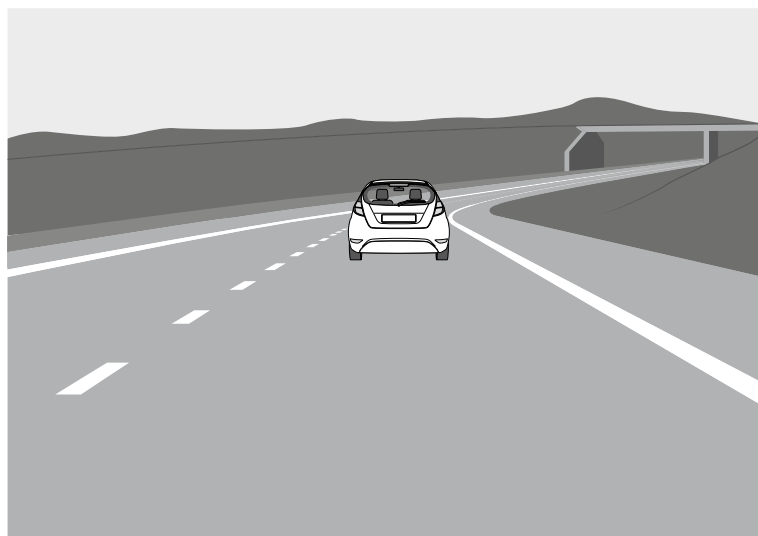

Bon

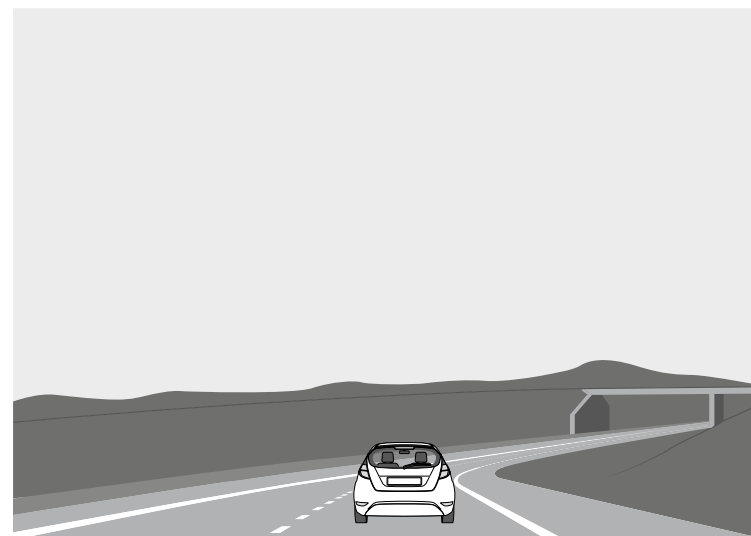

Mauvais



PARAMÈTRES MENU

Pour accéder aux paramètres du menu, appuyez sur le bouton « Paramètres » du menu principal.

Qualité vidéo : sélectionnez l'option requise (l'option la plus élevée offre des performances de visionnage optimales).

Résolution d'image : 1 à 12 mégapixels

Enregistrement en boucle : 1, 3 ou 5 minutes

Estampillage de la date : OFF / ON

Enregistrement audio : OFF / ON

Moniteur de stationnement : OFF / ON

Capteur G : OFF / LOW / MEDIUM / HIGH

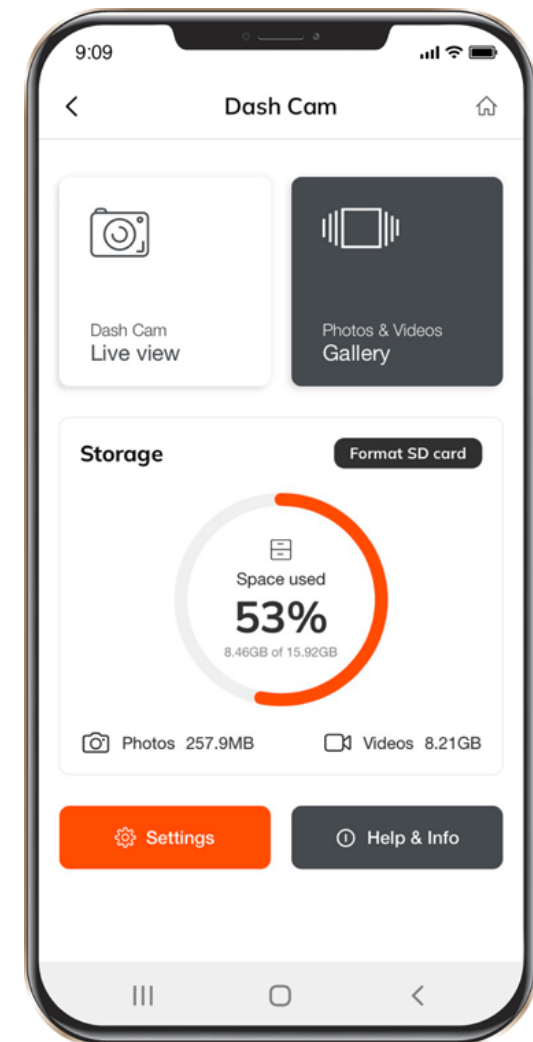

ENREGISTREMENT D'URGENCE

- 1** L'enregistrement d'urgence sert à protéger le fichier vidéo actuel contre l'écrasement et la suppression.
- 2** L'enregistrement d'urgence est activé automatiquement lorsque le capteur G se déclenche (accélération/décélération soudaine), ou à un point de collision. L'enregistrement d'urgence est verrouillé automatiquement pour éviter l'effacement pendant l'enregistrement en boucle.

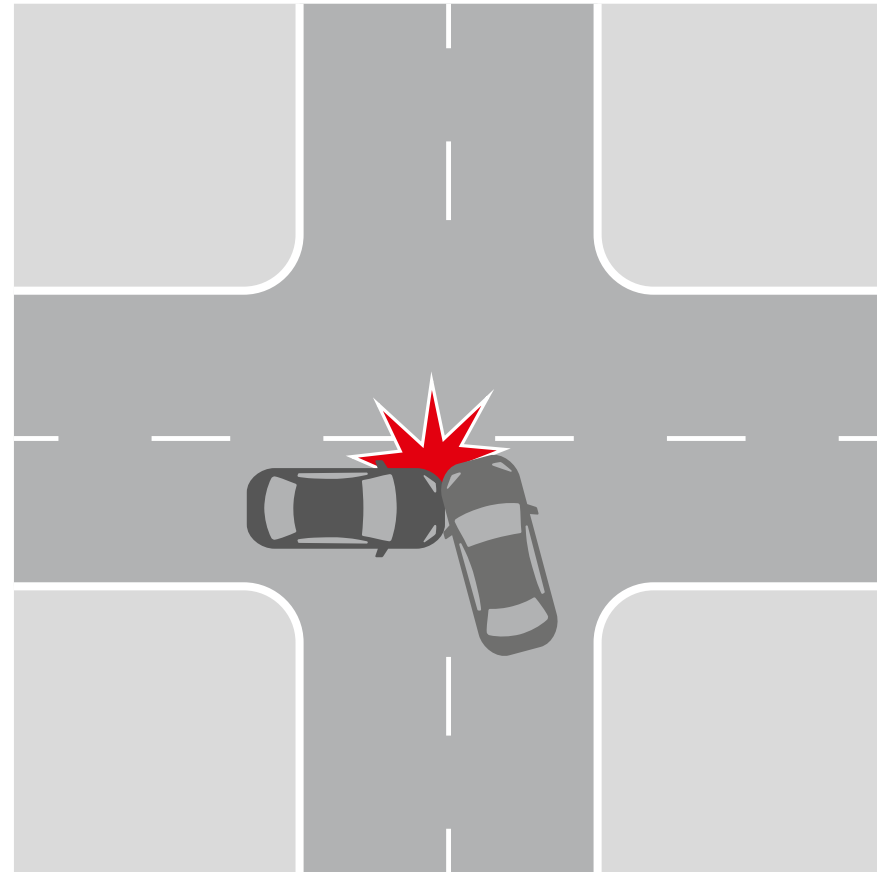

LECTURE D'ENREGISTREMENT



- 1 Pour accéder au menu de lecture, appuyez sur le bouton Album sur l'écran principal.
- 2 Menu Vidéo et Image.
 - Sélectionnez les vignettes Vidéos ou Images à afficher.





MENU VIDÉO

- 1 Appuyez brièvement une fois sur chaque fichier vidéo pour accéder au menu de lecture.
- 2 Appuyez sur chaque fichier vidéo et maintenez-le enfoncé pendant 3 secondes pour accéder au sous-menu de la vidéo. À partir de là, verrouillez, téléchargez, partagez ou supprimez la vidéo sélectionnée.





MENU IMAGE

- 1 Appuyez brièvement une fois sur chaque fichier image pour accéder au menu de lecture.
- 2 Appuyez sur chaque fichier image et maintenez-le enfoncé pendant 3 secondes pour accéder au sous-menu de la vidéo. À partir de là, verrouillez, téléchargez, partagez ou supprimez la image sélectionnée.

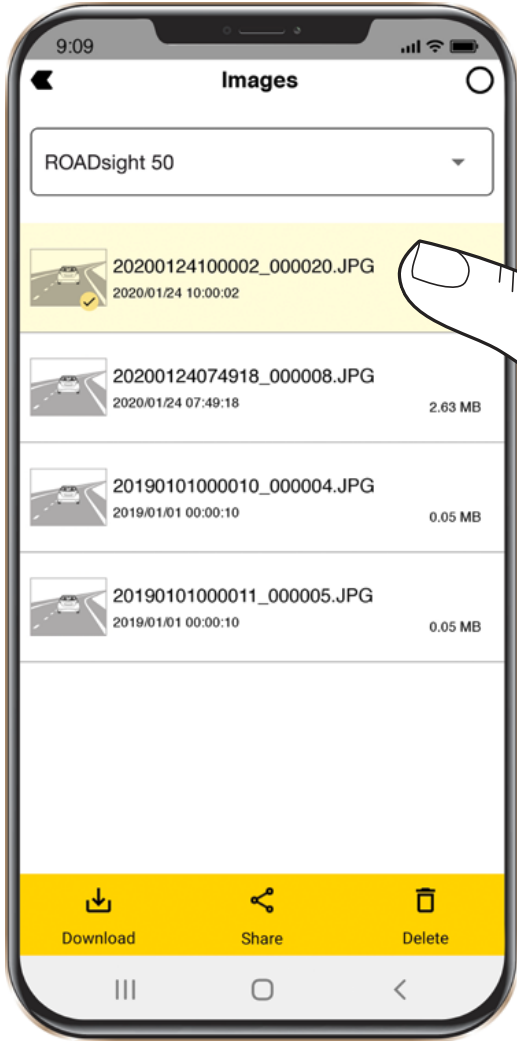



MENU FAQ

Pour accéder au menu FAQ, appuyez sur le menu déroulant et sélectionnez FAQ.

Faites glisser votre doigt vers le haut ou vers le bas pour afficher toutes les questions fréquemment posées.

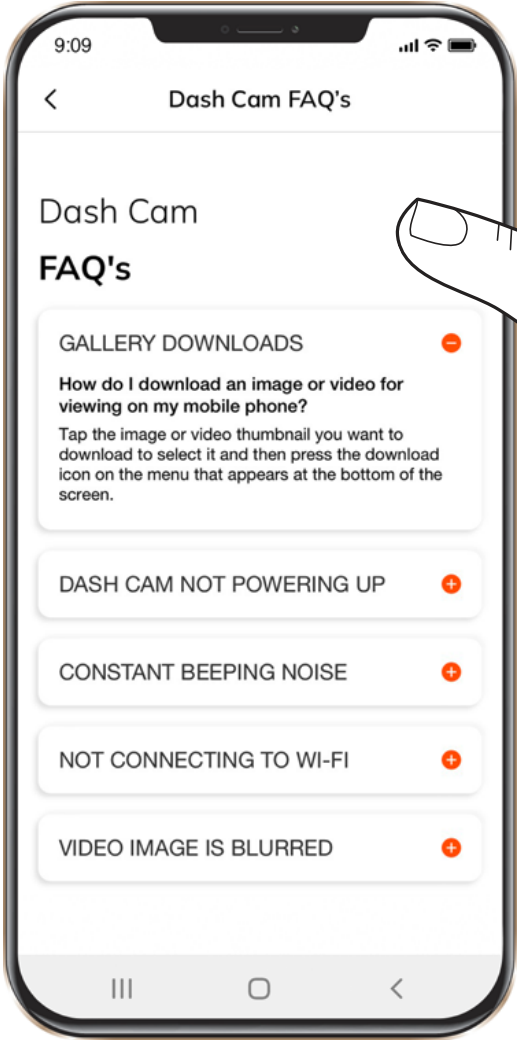

MENU GUIDE D'INSTALLATION



- 1** Pour accéder au menu du guide d'installation, appuyez sur le menu déroulant et sélectionnez Guide d'installation.
- 2** Un autre menu déroulant apparaîtra. Sélectionnez la caméra de bord utilisée dans le menu déroulant.

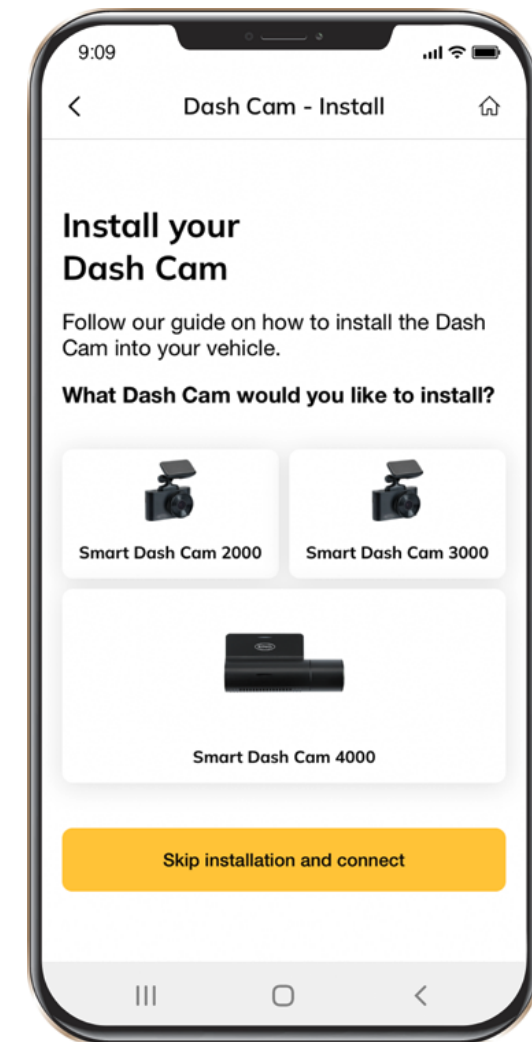



ÉCHEC DE LA PHOTOGRAPHIE/ ENREGISTREMENT DE LA VIDÉO

Vérifiez s'il y a suffisamment d'espace libre sur la carte micro SD.

L'ENREGISTREMENT S'EST ARRÊTÉ

Trop de fichiers vidéo stockés. N'utilisez qu'au moins des cartes micro SD haute vitesse de classe 10 U1 de fabricants reconnus.

Lorsque vous essayez de visualiser une photo/lire un fichier vidéo, le message « Mauvais fichier » apparaît.

Échec d'écriture de fichier en raison d'une erreur du système de fichier de la carte micro SD. Formater la carte Micro SD

IMAGE FLOUE

Assurez-vous de retirer l'autocollant d'objectif. Vérifiez la présence de saletés sur la lentille. S'il y en a, essuyez l'objectif avec un chiffon doux avant utilisation (il est recommandé d'utiliser des produits d'entretien spéciaux pour l'optique afin de ne pas endommager la surface de l'objectif).

SUSPENDRE (PAS D'IMAGE, PAS DE RÉPONSE DE BOUTON)



Appuyez sur le bouton RESET dans l'application pour redémarrer l'appareil.

Carte MicroSD non reconnue lorsqu'elle est utilisée dans la caméra de bord Ring Smart Dash Cam 4000 **

Veillez formater la carte *

















- 1** Assurez-vous que les cartes MicroSD sont correctement insérées dans la caméra de bord
- 2** Connectez la caméra de bord à l'application RINGconnect
- 3** Une fois la caméra de bord connectée à l'application, sélectionnez les paramètres « COG ICON »
- 4** Sélectionnez l'option FORMAT
- 4** Sélectionnez OUI pour FORMATER la carte MicroSD

* Formater la carte MicroSD supprimera toutes les informations et enregistrements de la carte MicroSD

** La caméra de bord émettra un bip constant si la carte n'est pas reconnue et doit être formatée> Remarque : si une carte micro SD de plus de 32 Go est utilisée, la dernière mise à jour du micrologiciel est requise.

CARACTÉRISTIQUES



Ring Smart Dash Cam 4000	1440p 	140° 	≤128 GB* 	≤20 HRS* 	Wi-Fi	GPS
Ring Smart Dash Cam 3000	1296p 	130° 	≤64 GB* 	≤12 HRS* 	Wi-Fi	GPS
Ring Smart Dash Cam 2000	1080p 	120° 	≤32 GB* 	≤6 HRS* 	Wi-Fi	
Ring Dash Cam 1000	720p 	110° 	≤32 GB* 	≤3 HRS* 		

* Full HD à 30 FPS.

** La durée d'enregistrement maximale dépend de la résolution de l'écran, de la taille de la carte mémoire et de la fixation de la caméra arrière.

EXIGENCES DE PUISSANCE



ATTENTION ! Une fois qu'il n'y a pas d'entrée d'alimentation externe, la batterie ne peut pas prendre en charge l'enregistrement pendant une longue période, veuillez vous assurer que l'alimentation est connectée lors de l'enregistrement.

Tension d'entrée : 5 V CC, 1,5 A

Tension d'entrée de charge : 12-24 V CC

Connexion mini USB pour l'alimentation

TEMPÉRATURES DE FONCTIONNEMENT (tous modèles)

Température de stockage : -20° C à 70 °C

Température de fonctionnement : -10° C à 60° C

VEUILLEZ RECYCLER VOS BATTERIES USÉES



Les batteries ne doivent pas être jetées dans les déchets municipaux non triés, mais collectées séparément pour faciliter le traitement et le recyclage corrects des substances qu'elles contiennent. Le recyclage des batteries assure la récupération de ces matériaux précieux et évite tout effet potentiellement nocif sur l'environnement et la santé humaine.



Ring Smart Dash Cam 4000

Dashcam HD 1296p

Español

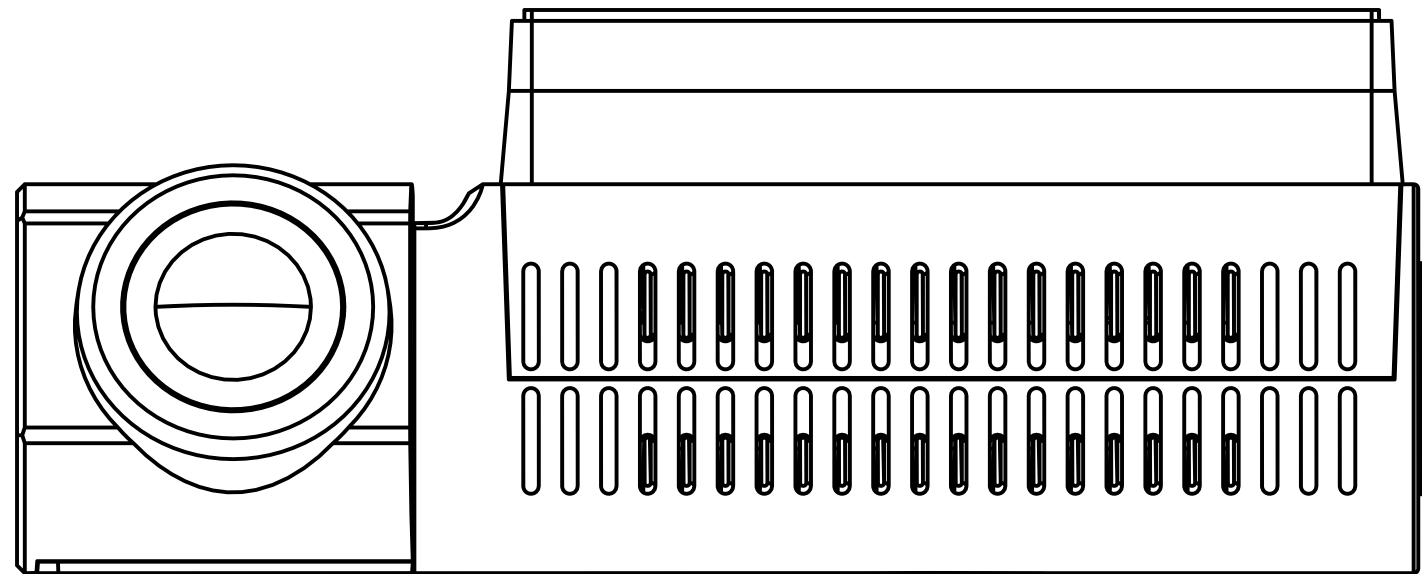

ATENCIÓN



- 1** Deben respetarse los requisitos especiales y la ley de cada país, especialmente en lo relativo a la duración de los registros/uso y la transferencia de datos. Familiarícese con las leyes de protección de datos de su país y asegúrese de cumplirlas. Además, familiarícese y cumpla con las leyes y reglamentos correspondientes sobre el uso y la propiedad de las cámaras de salpicadero («dashcams») en su país.

DE/AT: No están permitidas las grabaciones permanentes ni ocasionales, es decir, no se puede grabar todo el recorrido, matrículas ni desconocidos (la llamada función de bucle o «loop»). Cuando se graba un suceso, por ejemplo, un accidente, se debe informar a todas las partes implicadas sobre la grabación y sobre su cesión a la policía. Se prohíbe la publicación de grabaciones en medios públicos (Internet, redes sociales) sin el consentimiento de todas las personas afectadas o únicamente tras difuminar las personas y las matrículas. Debe ser imposible extraer conclusiones sobre las personas, por ejemplo, a través de imágenes del entorno.
- 2** La cámara de salpicadero no debe instalarse en una posición que impida al conductor ver la carretera.
- 3** Utilice únicamente el adaptador de corriente suministrado. De no hacerlo, se podría dañar la cámara de salpicadero. Tenga cuidado al limpiar la lente de la cámara de salpicadero y utilice únicamente un limpiador de lentes adecuado y un paño suave. NO exponga este producto a la lluvia, la humedad o el agua bajo ninguna circunstancia; si lo hace, puede correr el riesgo de sufrir una descarga eléctrica o un incendio. NO realice ningún otro tipo de mantenimiento que no esté incluido en el manual de instrucciones, a menos que esté cualificado para ello. Cuando se instale en un vehículo, coloque siempre el dispositivo de forma segura contra el parabrisas y, en la medida de lo posible, oculte el cable de alimentación bajo el revestimiento interior del vehículo. Asegúrese de que el cable de alimentación no interfiere con los mandos del conductor, como el volante, los pedales o la palanca de cambios. NO instale la cámara de salpicadero delante de la zona de despliegue del airbag o en una posición que oculte cualquier espejo interior. NO la utilice mientras conduce y únicamente ajuste los ajustes o revise las grabaciones mientras no conduce.



ANTES DE COMENZAR

Si aún no ha descargado la aplicación, hágalo ahora para sacar el máximo partido a su cámara de salpicadero.

- 1 Descargue la aplicación buscando RINGconnect en la App Store (iPhone) o en Google Play (Android).
- 2 Abra la aplicación, siga el proceso de configuración mostrado y active todos los ajustes necesarios cuando se le solicite.

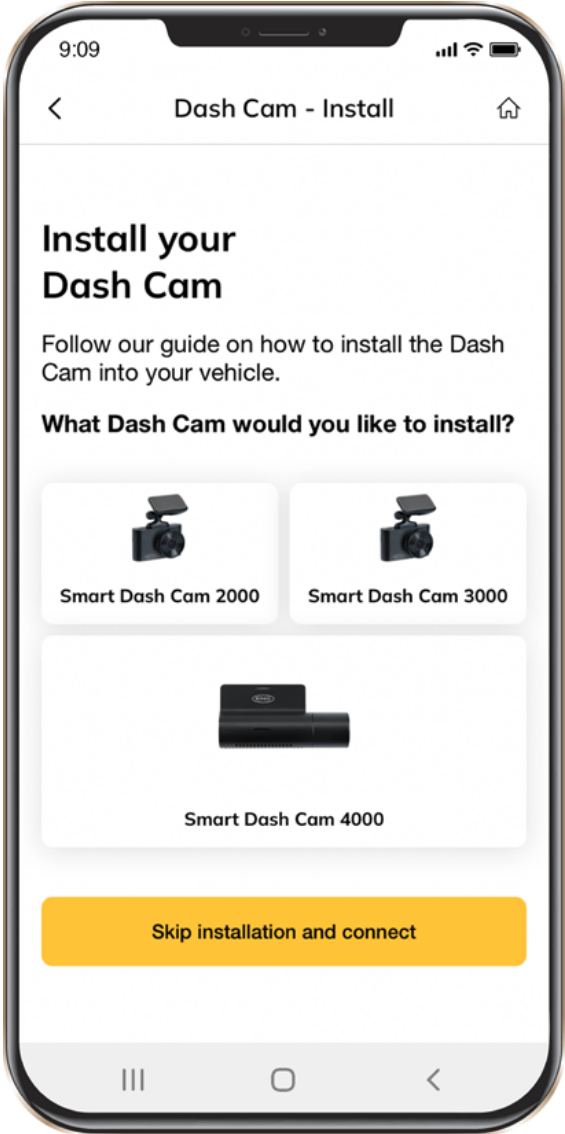



CONTENIDO DEL PAQUETE

- 1 Cámara de salpicadero
- 2 Guía de inicio rápido
- 3 Montaje magnético
- 4 Cable de carga USB
- 5 Herramienta para tapicería
- 6 Etiqueta de la ventana

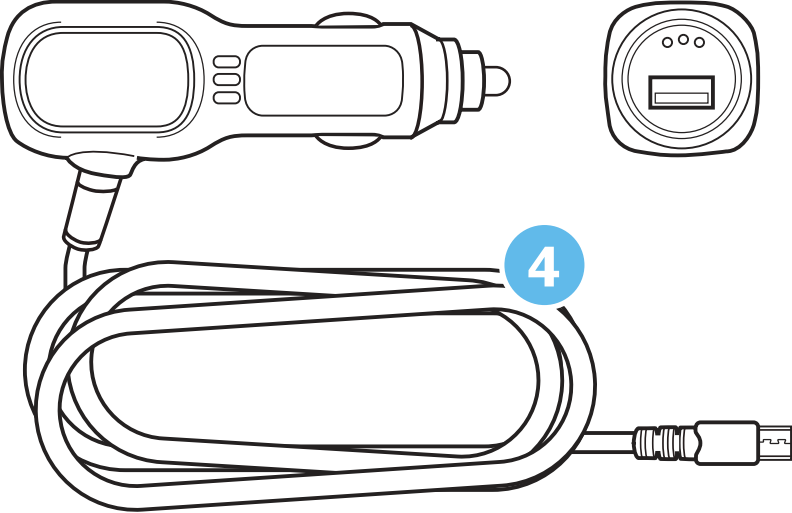
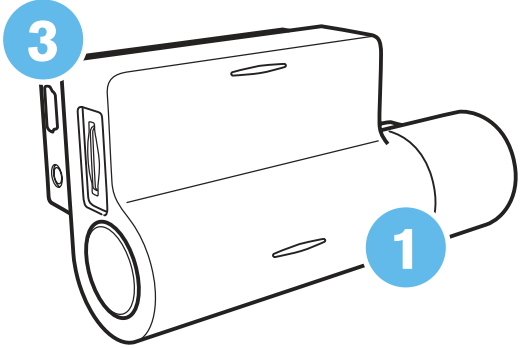
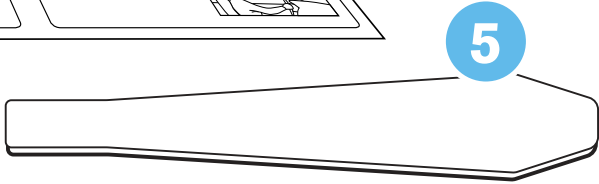
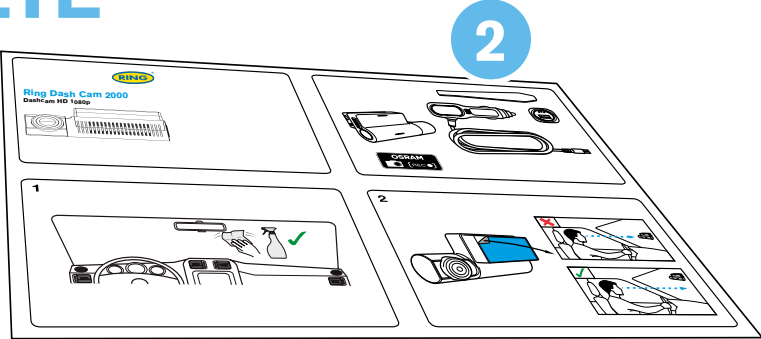



¡ATENCIÓN! Elija el lugar de instalación con antelación, ya que la cinta adhesiva de la montura es de un solo uso.

- 1** Asegúrese de que el cristal no tenga suciedad, polvo y grasa.
- 2** Caliente la parte de la almohadilla adhesiva con las manos para asegurar una sólida adhesión al cristal.
- 3** Una vez colocado el soporte, conecte la cámara de salpicadero al soporte magnético.

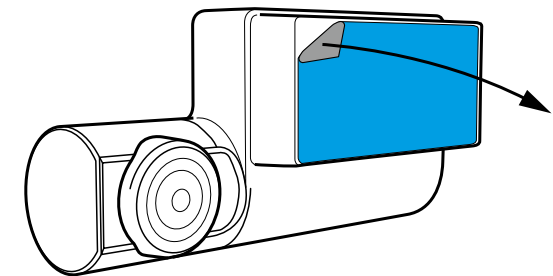
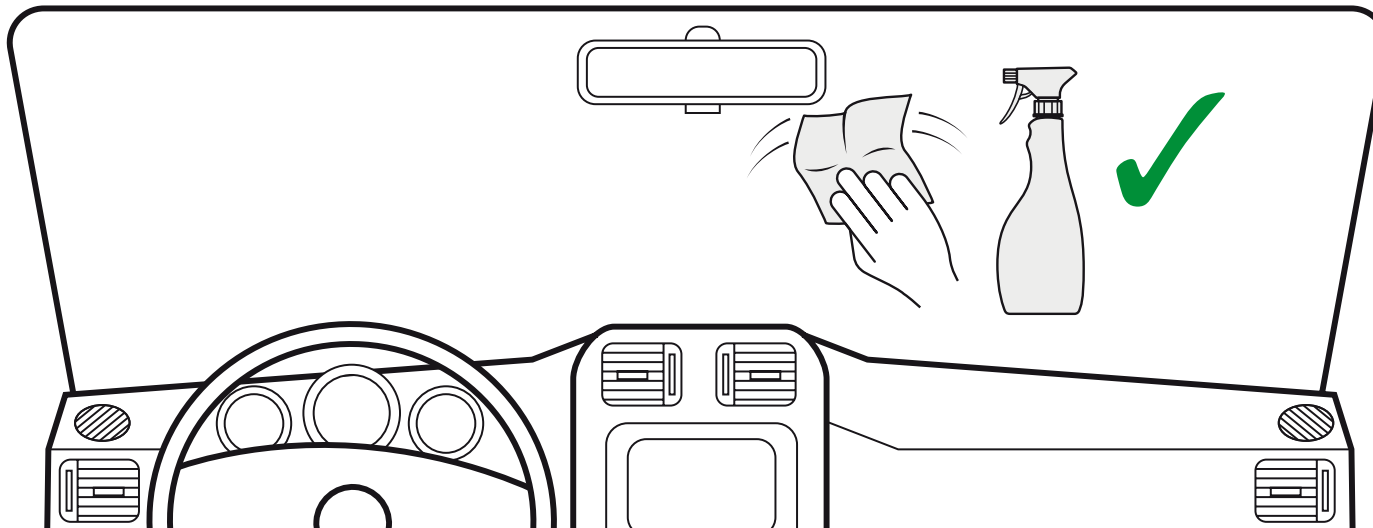



Para alimentar el dispositivo y cargar la batería, utilice únicamente el adaptador de corriente incluido. Conecte el cable de alimentación al soporte y, a continuación, conecte el cargador USB a la toma de corriente de 12 V del vehículo.

Cuando el motor del vehículo se pone en marcha, el dispositivo se enciende automáticamente.

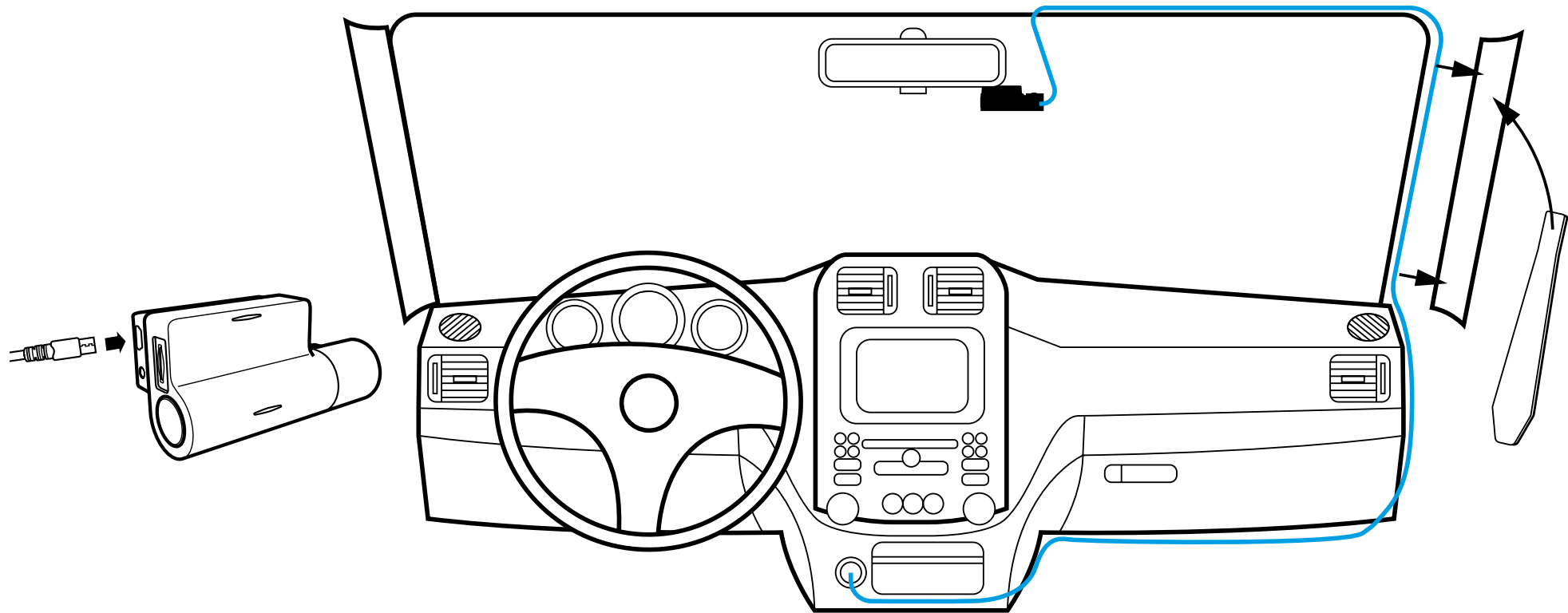

INSTALACIÓN DE LA TARJETA microSD



- 1** Antes de instalar una tarjeta de memoria, asegúrese de que el dispositivo está apagado.
- 2** Inserte la tarjeta de memoria hasta que encaje en su sitio.
- 3** Extracción de la tarjeta: presione ligeramente la tarjeta y luego retírela de la ranura.

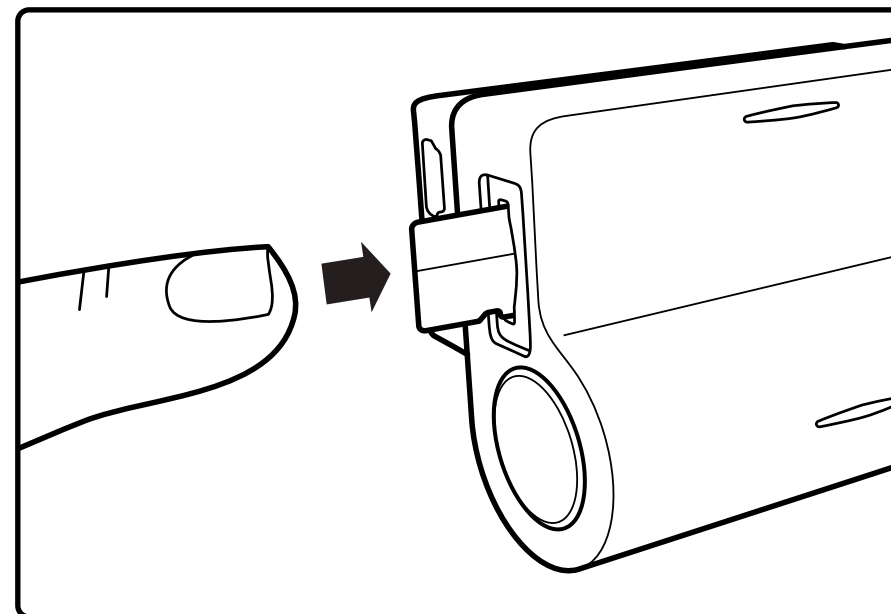

ADVERTENCIA No aplique una fuerza excesiva al insertar una tarjeta de memoria para evitar daños en el dispositivo. Si es necesario, utilice un dispositivo de punta fina para empujar la tarjeta. Para extraer la tarjeta de memoria, empuje la tarjeta hasta que haga clic y sáquela de la ranura.

ENCENDIDO / APAGADO



- Cuando el vehículo se pone en marcha, la cámara de salpicadero se enciende automáticamente.
- Para encender el dispositivo manualmente, pulse el botón de encendido.
- Para apagar el dispositivo, mantenga pulsado el botón de encendido durante unos 3 segundos.

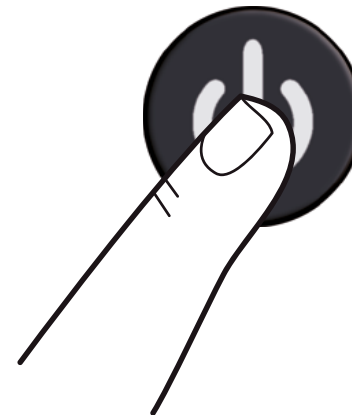
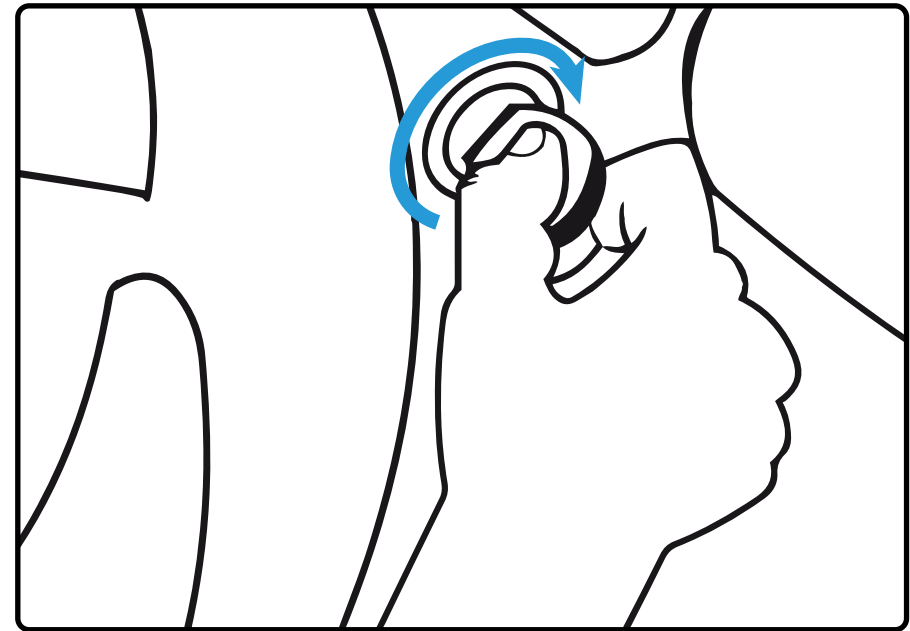



CONEXIÓN CON EL MÓVIL

- 1 Encienda la cámara de salpicadero.
- 2 La cámara emite automáticamente una red wifi.
- 3 Abra los Ajustes del teléfono.
- 4 Pulse Wifi o Conexiones.
- 5 Seleccione el punto de acceso de la cámara de salpicadero e introduzca la contraseña «12345678».
- 6 Ahora está conectado a su dispositivo.

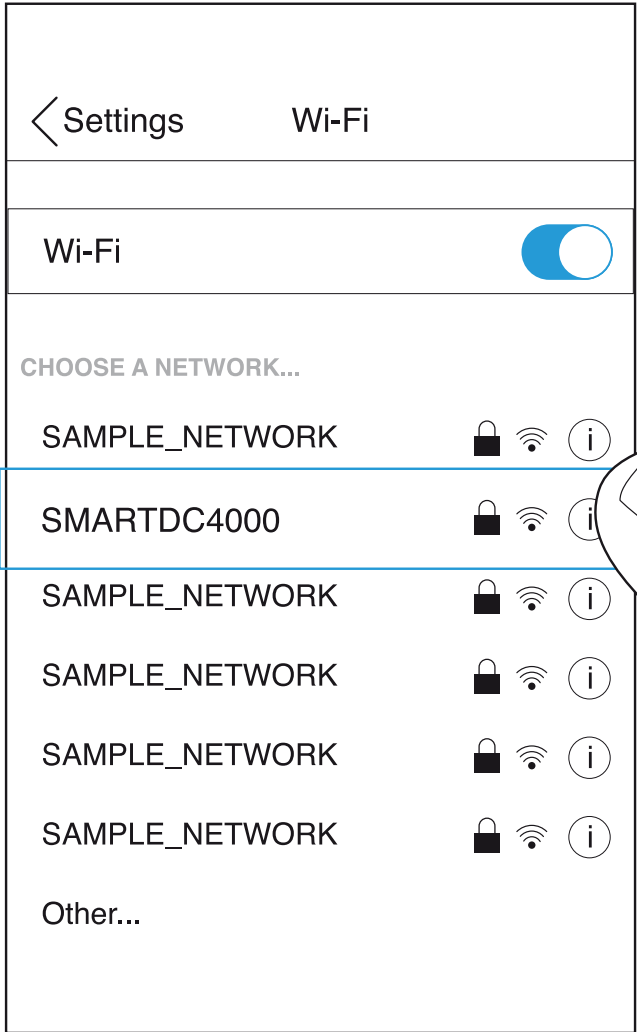
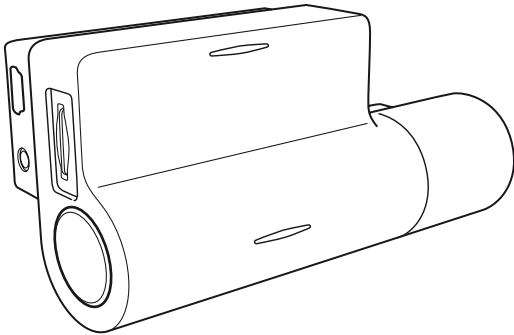

AJUSTE DEL ÁNGULO DE VISIÓN



¡ATENCIÓN! El ajuste del ángulo de visión solo puede hacerse a lo largo del eje vertical, por lo que debe asegurarse de colocar el dispositivo correctamente en el parabrisas a lo largo del eje horizontal, lo más cerca posible del centro del parabrisas.

Mientras ajusta el dispositivo en el soporte, asegúrese de que la cámara capta la imagen en las siguientes proporciones: 30 % de cielo y 70 % de carretera.

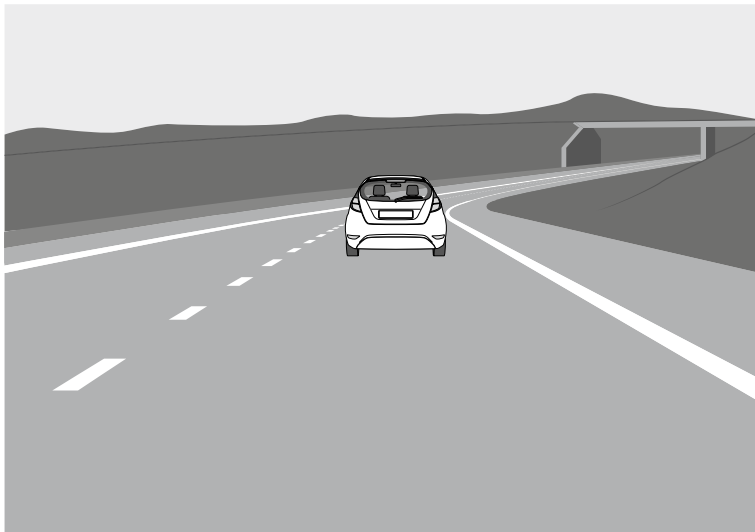

Bien

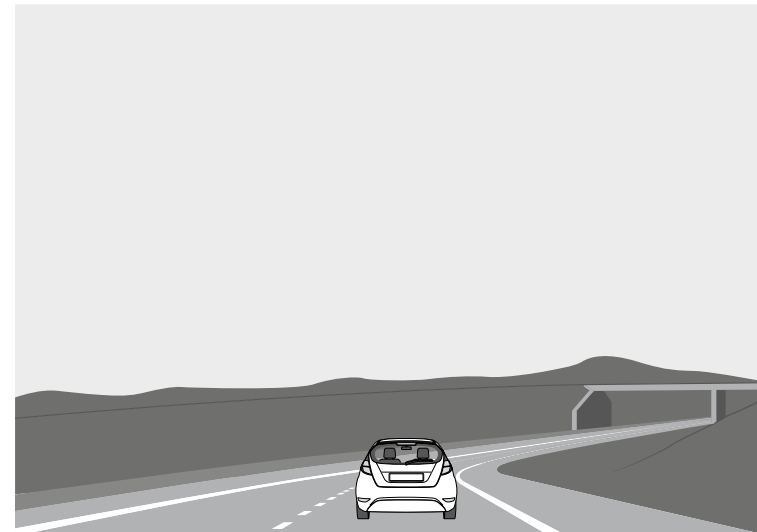

Mal

AJUSTES DEL MENÚ

Para acceder a los ajustes del menú, pulse el botón «Ajustes» en el menú principal.

Calidad del vídeo: Seleccione la opción requerida (la opción más alta proporciona el rendimiento óptimo de visualización).

Resolución de imagen: 1-12 megapíxeles

Grabación en bucle: 1, 3 o 5 minutos

Marcador de fecha: ENCENDIDO/APAGADO

Grabar audio: APAGADO/ENCENDIDO

Asistente de aparcamiento: APAGADO/ENCENDIDO

Sensor G: APAGADO/BAJO/MEDIO/ALTO

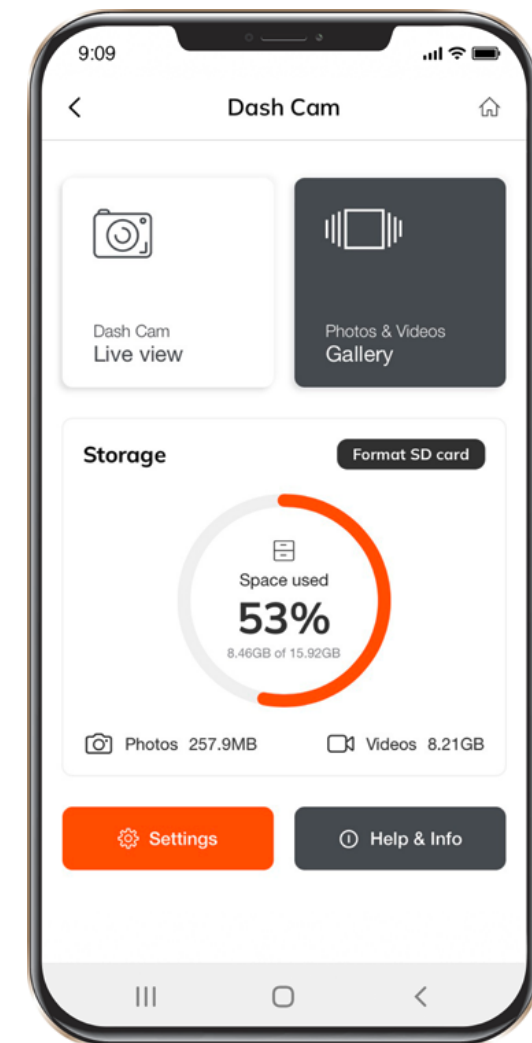

GRABACIÓN DE EMERGENCIA



- 1** La grabación de emergencia tiene el propósito de evitar que el archivo de vídeo actual se sobrescriba y se borre.
- 2** La grabación de emergencia se activa automáticamente cuando se dispara el sensor G (aceleración repentina/deceleración) o en el momento de colisión. La grabación de emergencia se bloquea automáticamente para evitar que se borre durante la grabación en bucle.

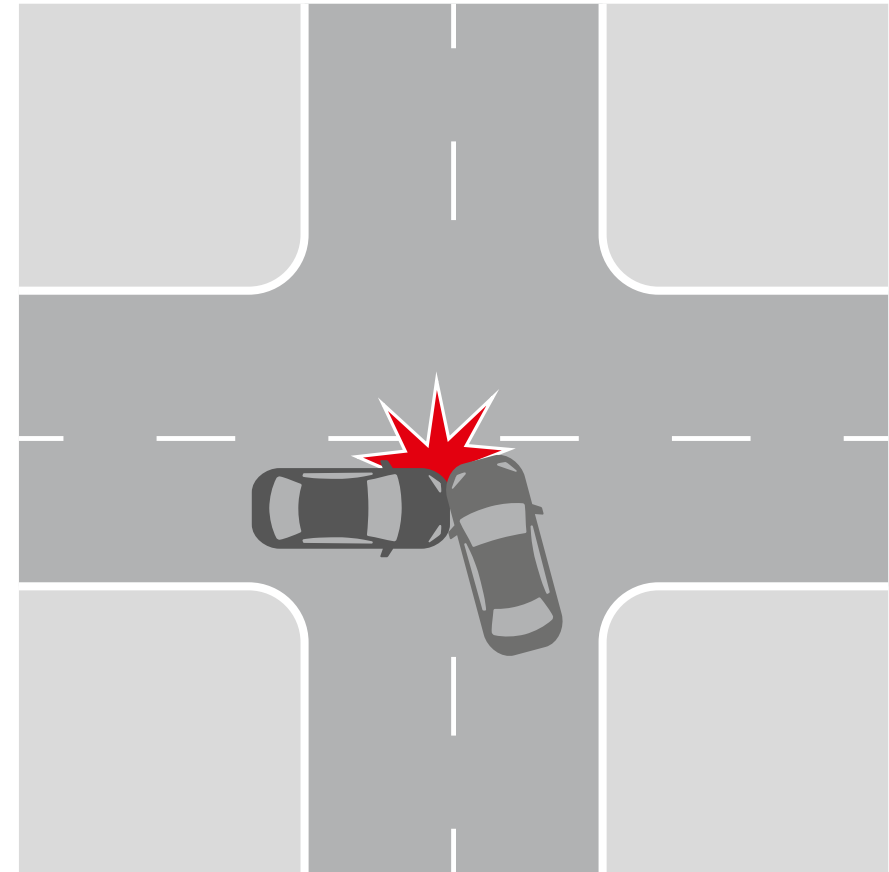

REPRODUCCIÓN DE GRABACIÓN



- 1 Para acceder al menú de reproducción, pulse el botón del álbum en la pantalla principal.
- 2 Menú de vídeo e imagen.
 - Seleccione los mosaicos de vídeos o imágenes para verlos.





MENÚ DE VÍDEO

- 1 Pulse brevemente cada archivo de vídeo una vez para acceder al menú de reproducción.
- 2 Mantenga pulsado cada archivo de vídeo durante 3 segundos para acceder al submenú del vídeo. Desde allí, bloquee, descargue, comparta o elimine el vídeo seleccionado.





MENÚ DE IMAGEN

- 1 Pulse brevemente cada archivo de imagen una vez para acceder al menú de reproducción.
- 2 Mantenga pulsado cada archivo de imagen durante 3 segundos para acceder al submenú del vídeo. Desde allí, bloquee, descargue, comparta o elimine la imagen seleccionada.



MENÚ DE PREGUNTAS FRECUENTES

Para acceder al Menú de Preguntas frecuentes, pulse el menú desplegable y seleccione Preguntas frecuentes.

Deslice el dedo hacia arriba o hacia abajo para ver todas las preguntas frecuentes.

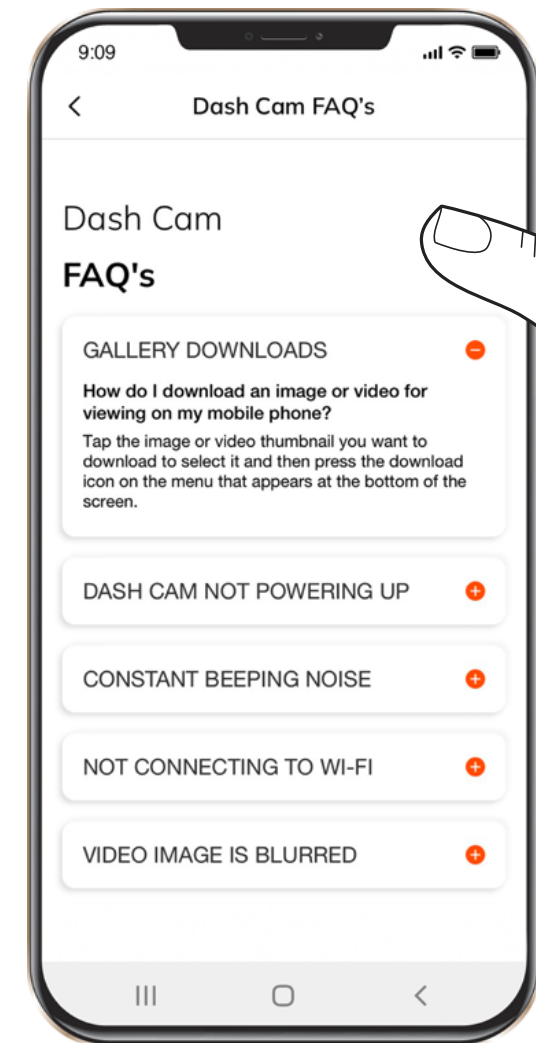

MENÚ DE LA GUÍA DE INSTALACIÓN



- 1** Para acceder al menú de la Guía de instalación, pulse el menú desplegable y seleccione Guía de instalación.
- 2** Aparecerá otro menú desplegable. Seleccione la cámara de salpicadero utilizada en el menú desplegable.

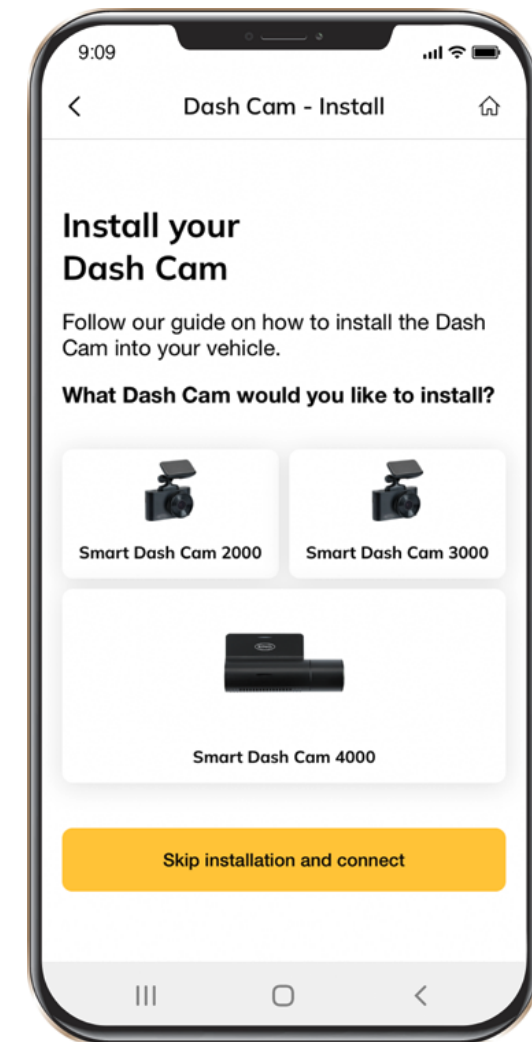



PROBLEMAS AL HACER FOTOS / GRABAR VÍDEOS

Compruebe si hay suficiente espacio libre en la tarjeta micro SD.

LA GRABACIÓN SE HA DETENIDO

Demasiados archivos de vídeo almacenados. Utilice solo tarjetas micro SD de alta velocidad como mínimo de clase 10 U1 de fabricantes reconocidos.

Cuando intenta ver una foto/reproducir un archivo de vídeo, aparece el mensaje «archivo incorrecto».

Fallo de escritura de archivos debido a un error del sistema de archivos de la tarjeta micro SD. Formatee la tarjeta micro SD.

IMAGEN BORROSA

Asegúrese de quitar la etiqueta adhesiva de la lente. Compruebe si hay suciedad en la lente. Si la hubiera, limpie la lente con un paño suave antes de utilizarla (se recomienda utilizar productos especiales para el cuidado de la óptica con el objetivo de no dañar la superficie de la lente).

SE CUELGA (NO HAY IMAGEN, LOS BOTONES NO RESPONDEN)



Presione el botón RESET en la aplicación para reiniciar el dispositivo.

La tarjeta MicroSD no se reconoce cuando se utiliza en la cámara de salpicadero Ring Smart Dash Cam 4000 **

Formatee la tarjeta *

















- 1** Asegúrese de que las tarjetas MicroSD se insertan correctamente en la cámara de salpicadero
- 2** Conecte la cámara de salpicadero a la aplicación RINGconnect
- 3** Una vez que la cámara de salpicadero esté conectada a la aplicación, seleccione la configuración «COG ICON».
- 4** Seleccione la opción FORMATO
- 5** Seleccione SÍ para FORMATEAR la tarjeta MicroSD

***** Formatear la tarjeta MicroSD borrará toda la información y las grabaciones de la tarjeta MicroSD

****** La cámara de salpicadero emitirá un pitido constante si no se reconoce la tarjeta y es necesario formatearla
Nota: Si se utiliza una tarjeta micro SD de más de 32 GB, se requiere la última actualización del firmware.

CARACTERÍSTICAS



Ring Smart Dash Cam 4000	1440p 	140° 	≤128 GB* 	≤20 HRS* 	Wi-Fi	GPS
Ring Smart Dash Cam 3000	1296p 	130° 	≤64 GB* 	≤12 HRS* 	Wi-Fi	GPS
Ring Smart Dash Cam 2000	1080p 	120° 	≤32 GB* 	≤6 HRS* 	Wi-Fi	
Ring Dash Cam 1000	720p 	110° 	≤32 GB* 	≤3 HRS* 		

* Full HD a 30 FPS.

** El tiempo máximo de grabación depende de la resolución de la pantalla, el tamaño de la tarjeta de memoria y el montaje de la cámara trasera.

REQUISITOS DE ENERGÍA



¡ATENCIÓN! Cuando no hay entrada de energía externa, la batería no puede soportar la grabación durante mucho tiempo. Asegúrese de que la fuente de alimentación está conectada cuando grabe.

Voltaje de entrada: 5 V CC, 1,5 A

Voltaje de entrada de carga: 12-24 V CC

Conexión mini USB para alimentación

TEMPERATURAS DE FUNCIONAMIENTO (todos los modelos)

Temperatura de almacenamiento: -20 °C a 70 °C

Temperatura de funcionamiento: -10 °C a 60 °C

RECICLE LAS PILAS GASTADAS



Las pilas no deben depositarse en la basura municipal sin clasificar, sino que deben recogerse por separado para facilitar el correcto tratamiento y reciclaje de las sustancias que contienen. El reciclaje de las pilas garantiza la recuperación de estos valiosos materiales y evita cualquier efecto potencialmente perjudicial tanto para el medioambiente como para la salud humana.



Ring Smart Dash Cam 4000

Dashcam HD 1296p

Italiano

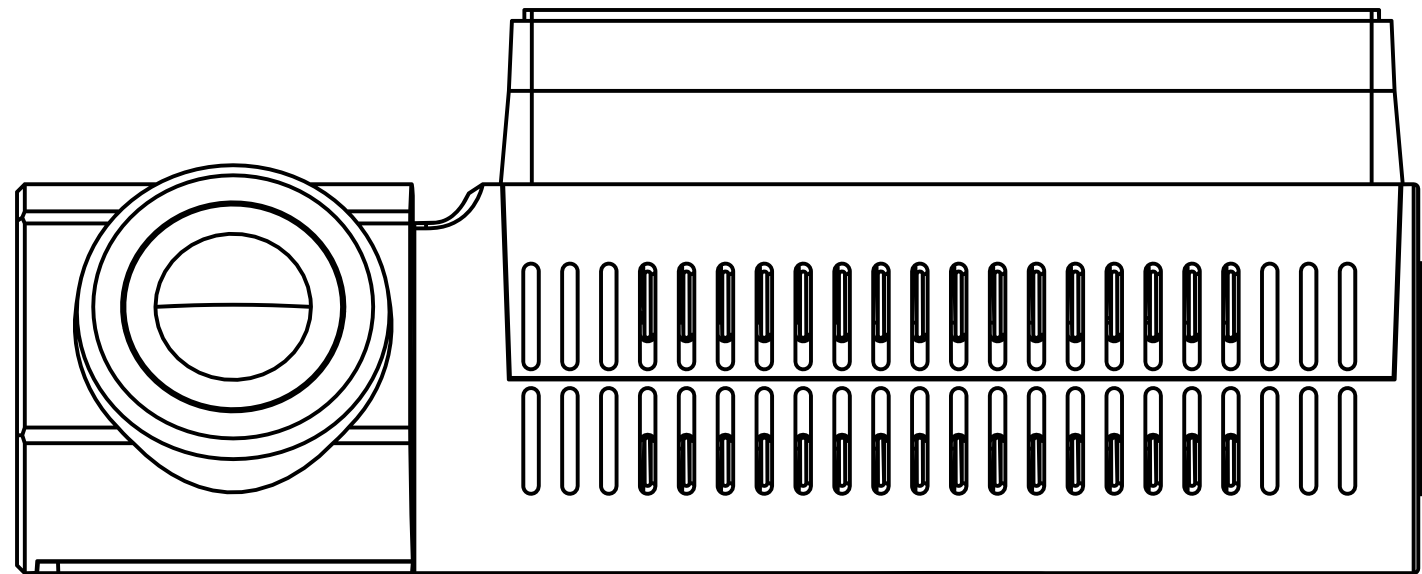



AVVERTENZA

- 1** Devono essere osservati i requisiti speciali individuali e la legislazione dei paesi, in particolare per quanto riguarda la durata della registrazione/l'utilizzo e il trasferimento dei dati. Acquisire familiarità con le leggi sulla protezione dei dati del proprio paese e assicurarsi di rispettarle. Si prega inoltre di acquisire familiarità con, e di rispettare le leggi e le normative pertinenti relative all'uso e al possesso delle dashcam nel proprio paese.

DE/AT: non sono consentite registrazioni permanenti e non occasionali, vale a dire nessuna registrazione dell'intero percorso, targhe o estranei (cosiddetta funzione loop). Durante la registrazione di un evento, ad esempio un incidente, tutte le parti coinvolte devono essere informate della registrazione e del suo trasferimento alla polizia. Nessuna pubblicazione di registrazioni su media pubblici (Internet, social media) senza il consenso di tutte le persone interessate o solo dopo aver mascherato le persone e le targhe. Deve essere impossibile trarre conclusioni sulle persone, ad esempio attraverso immagini dell'ambiente circostante.
- 2** La dashcam non deve essere montata in una posizione che ostruisce la visuale della strada davanti al conducente.
- 3** Utilizzare solo l'adattatore di alimentazione in dotazione, altrimenti si potrebbe danneggiare la dashcam. Fare attenzione quando si pulisce l'obiettivo della dash cam e utilizzare solo un detergente per lenti adatto e un panno morbido. **NON** esporre questo prodotto a pioggia, umidità o acqua in nessuna circostanza; ciò potrebbe provocare il rischio di scosse elettriche o incendi. **NON** eseguire interventi di manutenzione diversi da quelli contenuti nel manuale di istruzioni, a meno che non si sia qualificati per farlo. Durante l'installazione su un veicolo, posizionare sempre saldamente il dispositivo contro il parabrezza e, ove possibile, nascondere il cavo di alimentazione sotto il rivestimento interno del veicolo. Assicurarsi che il cavo di alimentazione non interferisca con i comandi del conducente come il volante, i pedali o la leva del cambio. **NON** montare la dashcam davanti a un'area di apertura degli airbag o in una posizione tale da nascondere la visuale degli specchietti interni. **NON** operare durante la guida e regolare le impostazioni o rivedere le registrazioni solo mentre non si guida.



PRIMA DI INIZIARE

Se non si è già scaricata l'app, farlo ora per ottenere il massimo dalla dashcam.

- 1 Scaricare l'app cercando RINGconnect nell'App Store (iPhone) o in Google Play (Android).
- 2 Aprire l'app, seguire la procedura di configurazione mostrata e abilitare tutte le impostazioni necessarie quando richiesto.

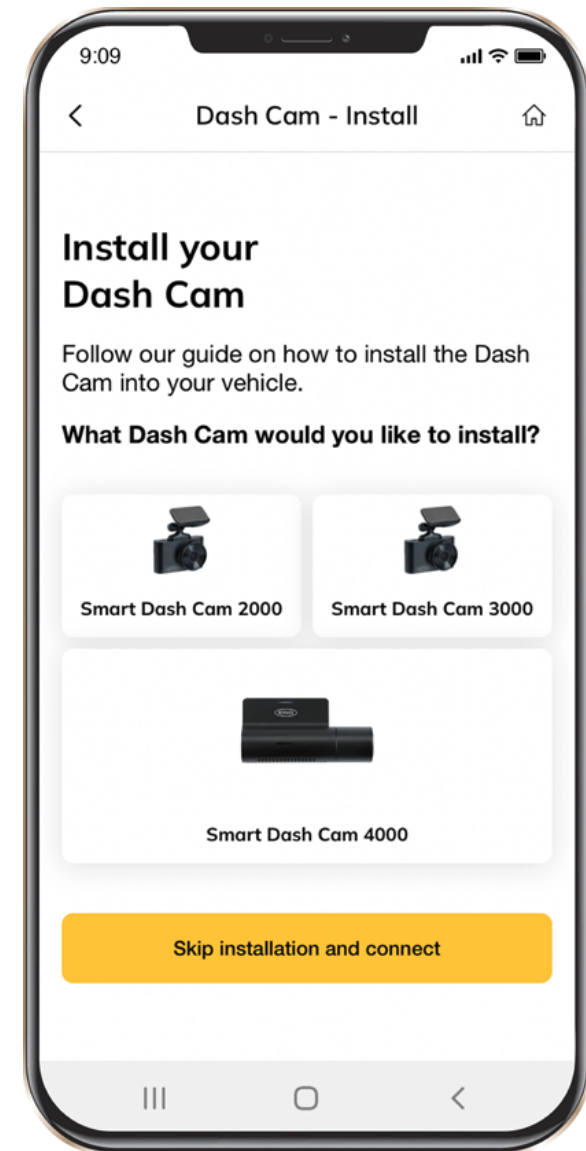



CONTENUTO DELLA CONFEZIONE

- 1 Dashcam
- 2 Guida rapida per iniziare
- 3 Supporto magnetico
- 4 Cavo di ricarica USB
- 5 Strumento di rimozione del rivestimento
- 6 Adesivo per finestrino

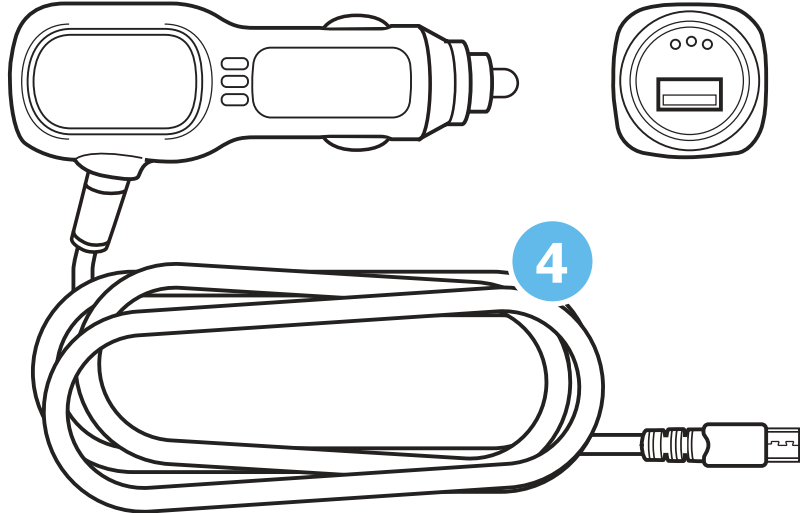
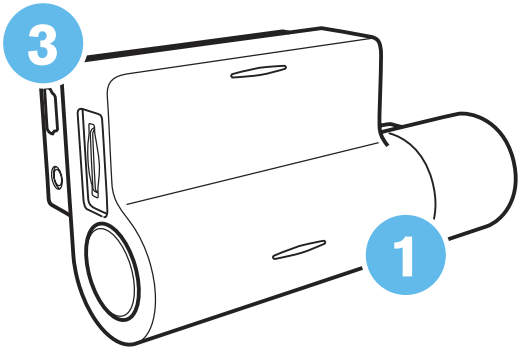
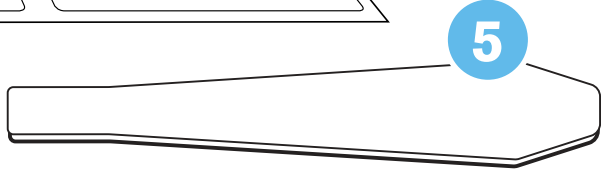
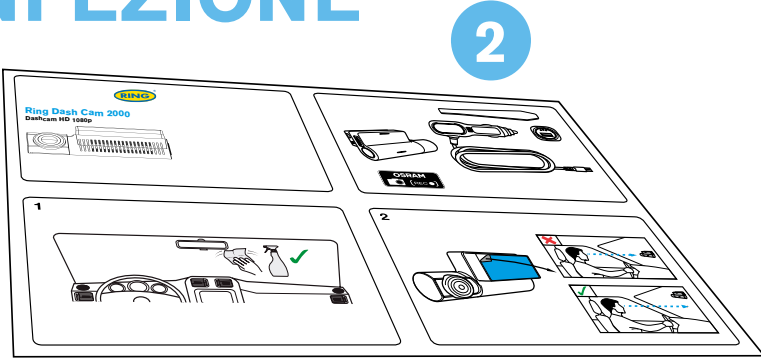



ATTENZIONE! Scegliere in anticipo la posizione di installazione, poiché il nastro adesivo sul supporto è monouso.

- 1** Assicurarsi che il vetro sia privo di sporco, polvere e grasso.
- 2** Riscaldare con le mani la parte di adesivo del supporto per garantire una forte adesione al vetro.
- 3** Una volta posizionato il supporto, collegare la dashcam al supporto magnetico.

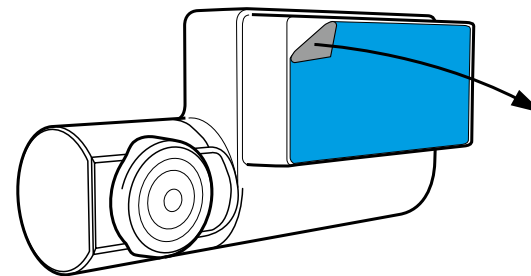
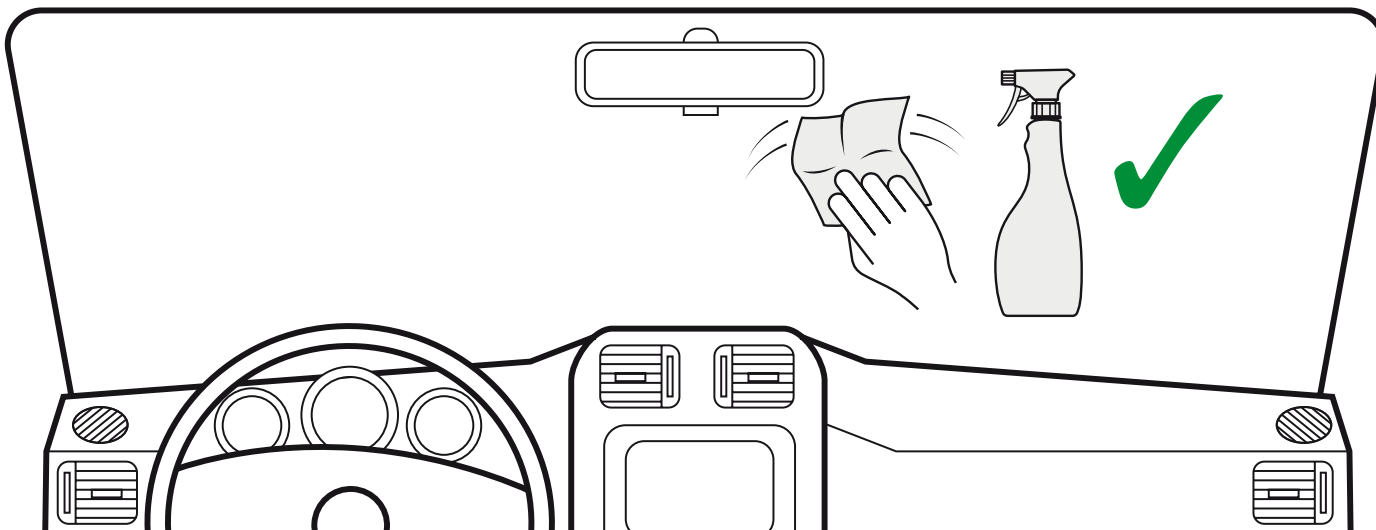



Per alimentare il dispositivo e caricare la batteria, utilizzare solo l'adattatore di alimentazione incluso. Collegare il cavo di alimentazione al supporto, quindi collegare il caricatore USB alla presa di alimentazione a 12V del veicolo.

Quando il motore del veicolo si avvia, il dispositivo si accende automaticamente.

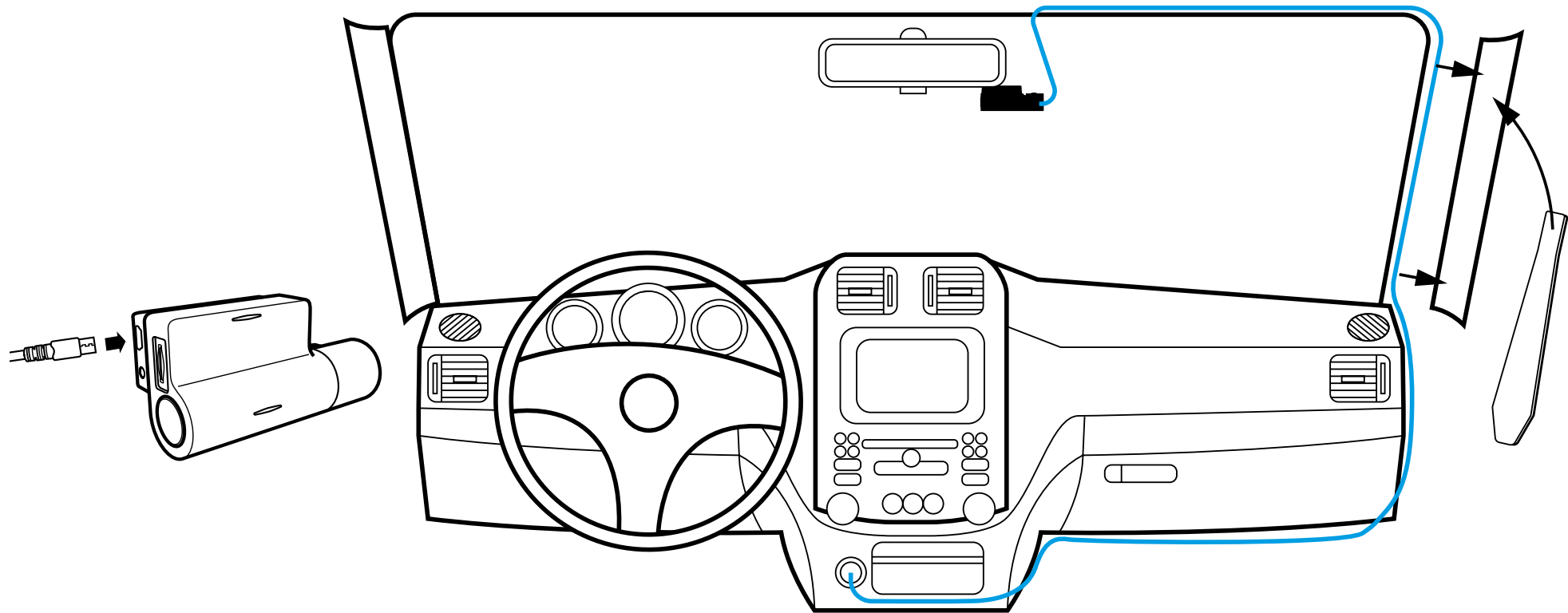

INSTALLAZIONE DELLA SCHEDA microSD



- 1** Prima di installare una scheda di memoria, assicurarsi che il dispositivo sia spento.
- 2** Inserire la scheda di memoria finché non scatta in posizione.
- 3** Rimozione di una scheda: premere leggermente la scheda e quindi rimuoverla dallo slot.

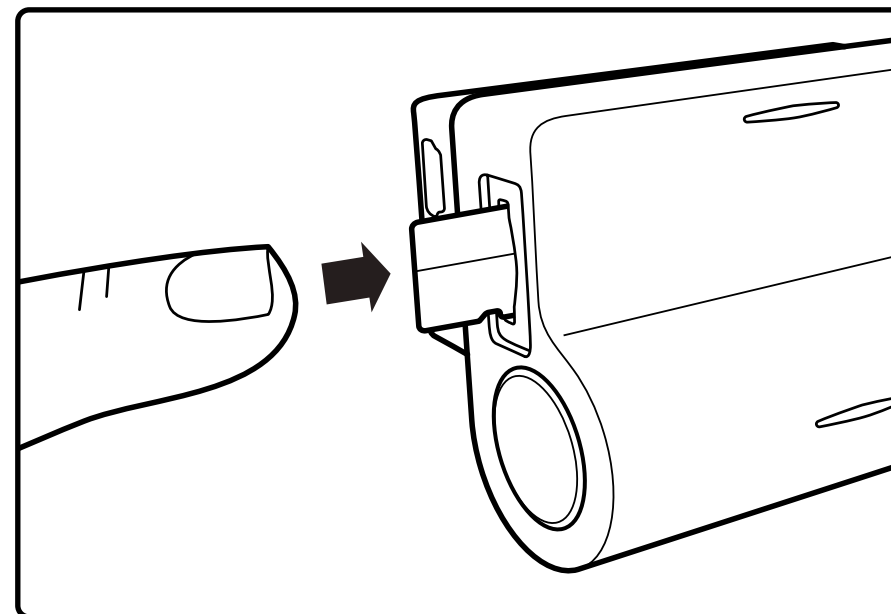

AVVERTENZA! Non applicare una forza eccessiva quando si inserisce una scheda di memoria per evitare danni al dispositivo. Se necessario, utilizzare un oggetto appuntito sottile per spingere più a fondo la scheda. Per rimuovere la scheda di memoria, spingere la scheda finché non scatta e rimuovere la scheda dallo slot.

ACCENSIONE / SPEGNIMENTO



- Quando si porta su ON il blocchetto di accensione del veicolo, la dashcam si accende automaticamente.
- Per accendere manualmente il dispositivo, premere il pulsante di accensione.
- Per spegnere il dispositivo, tenere premuto il pulsante di accensione per ca. 3 secondi.

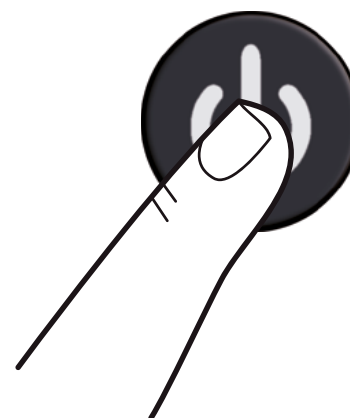
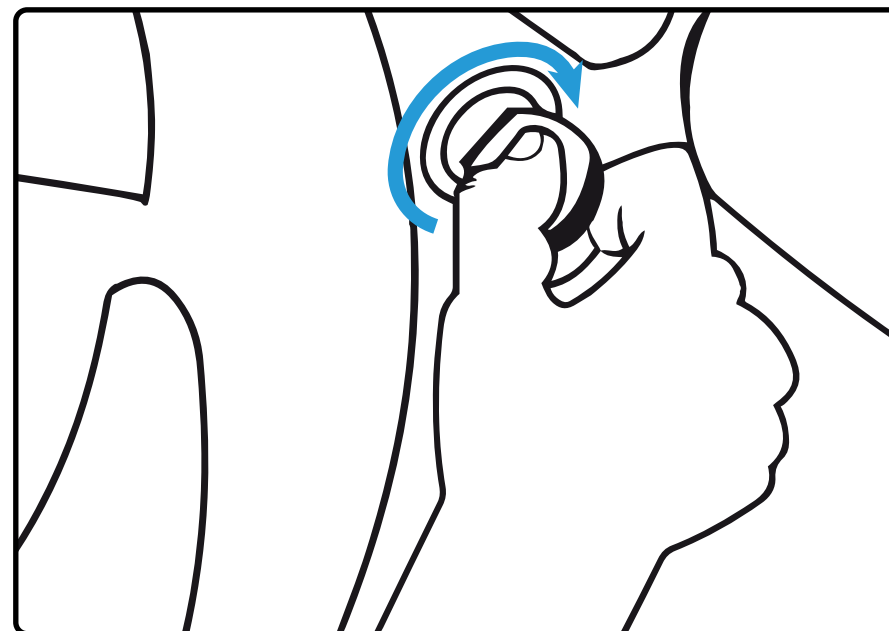



CONNESSIONE CON IL CELLULARE

- 1 Accendere la dashcam.
- 2 La fotocamera trasmette automaticamente una rete Wi-Fi.
- 3 Aprire le Impostazioni del telefono.
- 4 Toccare Wi-Fi o Connessioni.
- 5 Selezionare l'hotspot dashcam e immettere la password "12345678".
- 6 Ora si è connessi con il dispositivo.

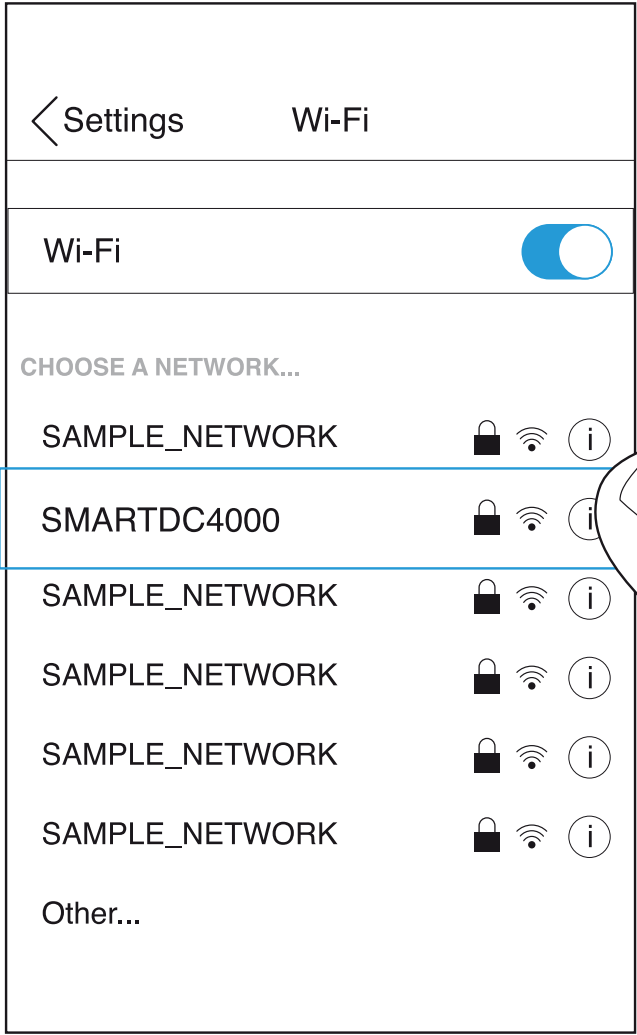
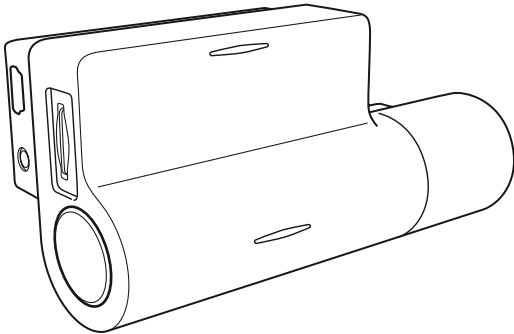

REGOLAZIONE DELL'ANGOLO DI VISIONE



ATTENZIONE! La regolazione dell'angolo di visione può essere eseguita solo lungo l'asse verticale, quindi assicurarsi di posizionare correttamente il dispositivo sul parabrezza lungo l'asse orizzontale il più vicino possibile al centro del parabrezza.

Mentre si tira o si spinge il dispositivo nel ritegno, assicurarsi che la fotocamera acquisisca l'immagine in proporzioni del 30% di cielo / 70% di strada.

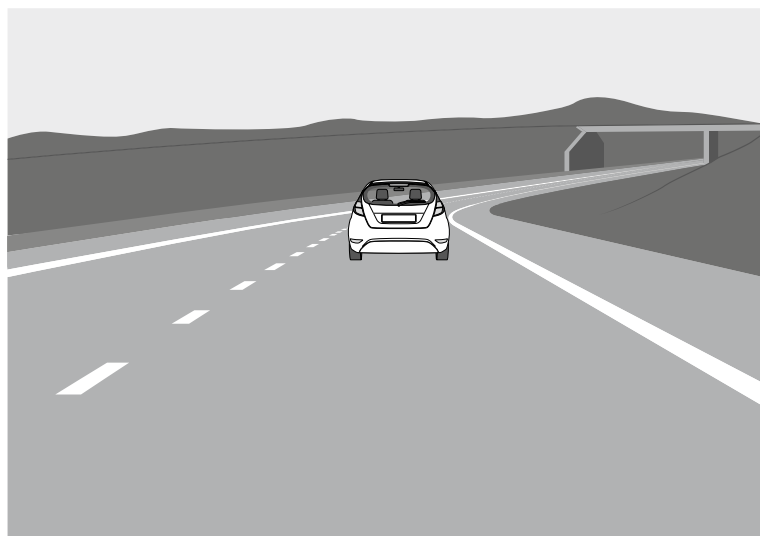

Giusto

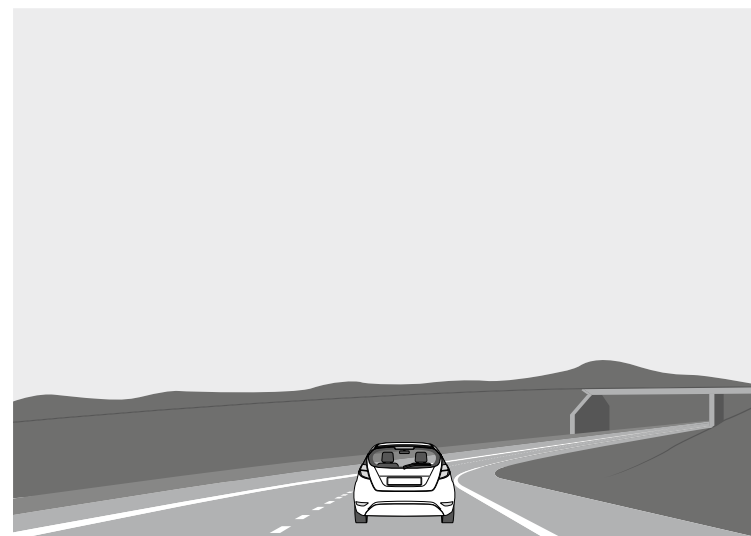

Sbagliato

IMPOSTAZIONI MENU

Per accedere alle Impostazioni menu, premere il pulsante "Impostazioni" nel menu principale.

Qualità video: selezionare l'opzione richiesta (l'opzione più alta offre le prestazioni di visione ottimali).

Risoluzione dell'immagine:

1-12 Megapixel

Registrazione in loop: 1, 3 o 5 minuti

Timbro data: OFF / ON

Registrazione audio: OFF / ON

Monitor di parcheggio: OFF / ON

Sensore G:

OFF / BASSO / MEDIO / ALTO

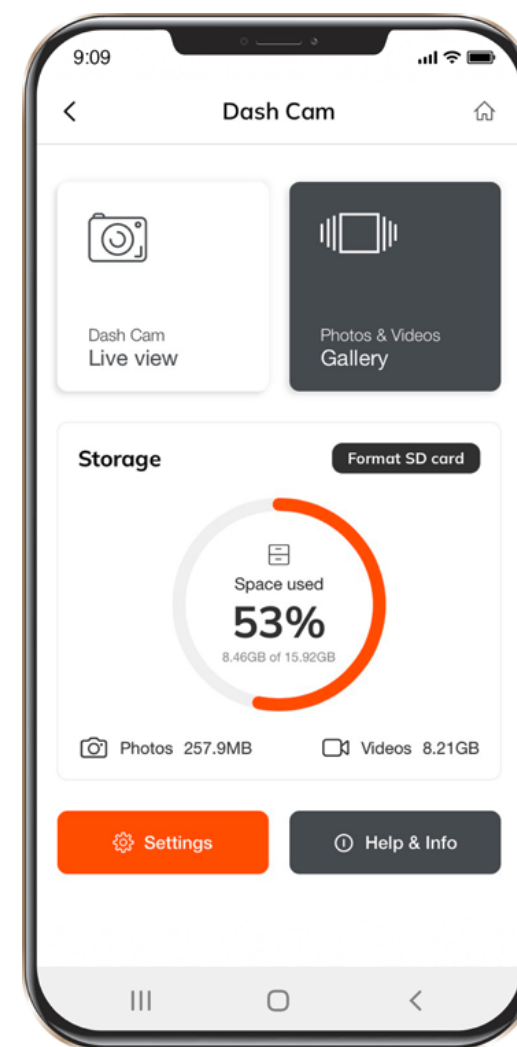

REGISTRAZIONE DI EMERGENZA



- 1** La registrazione di emergenza serve a proteggere il file video corrente dalla sovrascrittura e dall'eliminazione.
- 2** La registrazione di emergenza viene attivata automaticamente quando il sensore G si attiva (accelerazione/decelerazione improvvisa) o al punto di collisione. La registrazione di emergenza viene bloccata automaticamente per evitare la cancellazione durante la registrazione in loop.

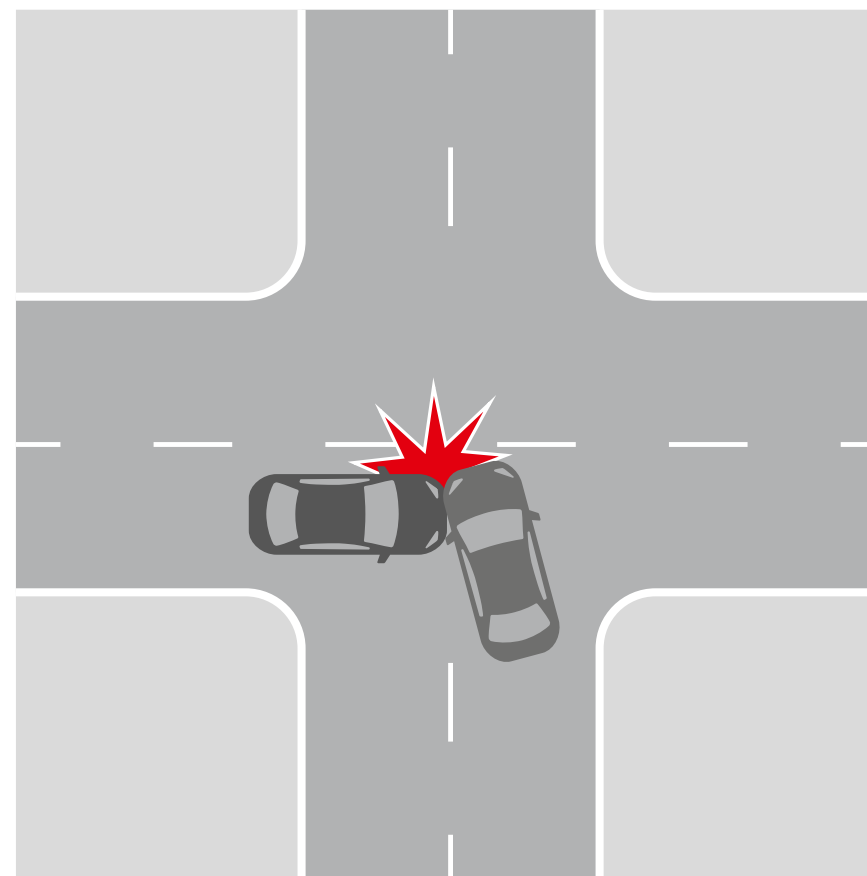

RIPRODUZIONE DELLA REGISTRAZIONE



- 1 Per accedere al menu di riproduzione, premere il pulsante album nella schermata principale.
- 2 Menu video e immagine.
 - Selezionare i riquadri Video o Immagini da visualizzare.





MENU VIDEO

- 1 Premere brevemente una volta ciascun file video per accedere al menu di riproduzione.
- 2 Tenere premuto ciascun file video per 3 secondi per accedere al sottomenu del video. Da qui, bloccare, scaricare, condividere o eliminare il video selezionato.





MENU IMMAGINE

- 1 Premere brevemente una volta ciascun file immagine per accedere al menu di riproduzione.
- 2 Tenere premuto ciascun file immagine per 3 secondi per accedere al sottomenu del video. Da qui, bloccare, scaricare, condividere o eliminare l'immagine selezionata.

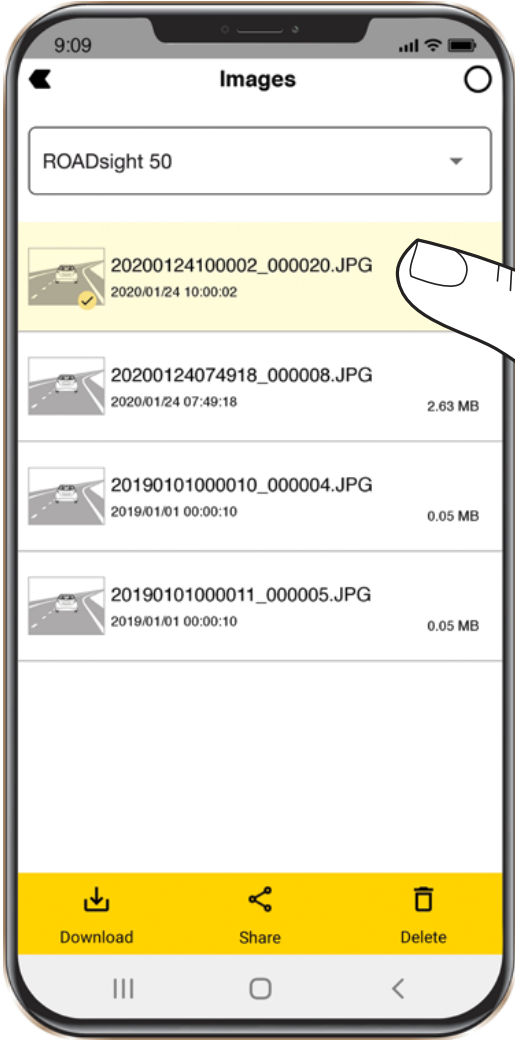

MENU FAQ

Per accedere al menu delle domande frequenti, premere il menu a discesa e selezionare FAQ.

Scorrere verso l'alto o verso il basso per visualizzare tutte le domande frequenti più comuni.

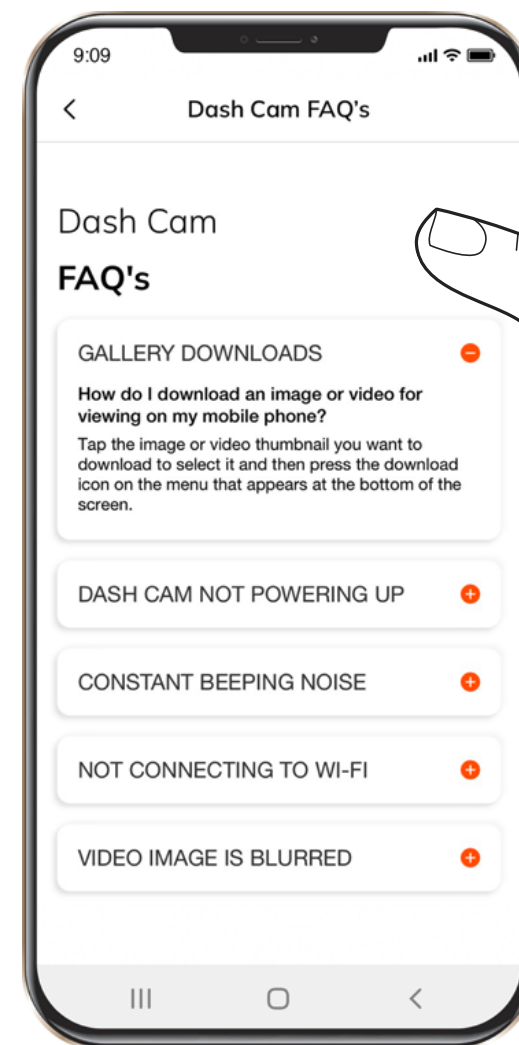

MENU GUIDA ALL'INSTALLAZIONE



- 1** Per accedere al menu Guida all'installazione, premere il menu a discesa e selezionare Guida all'installazione.
- 2** Apparirà un altro menu a discesa. Selezionare la dashcam in uso dal menu a discesa.

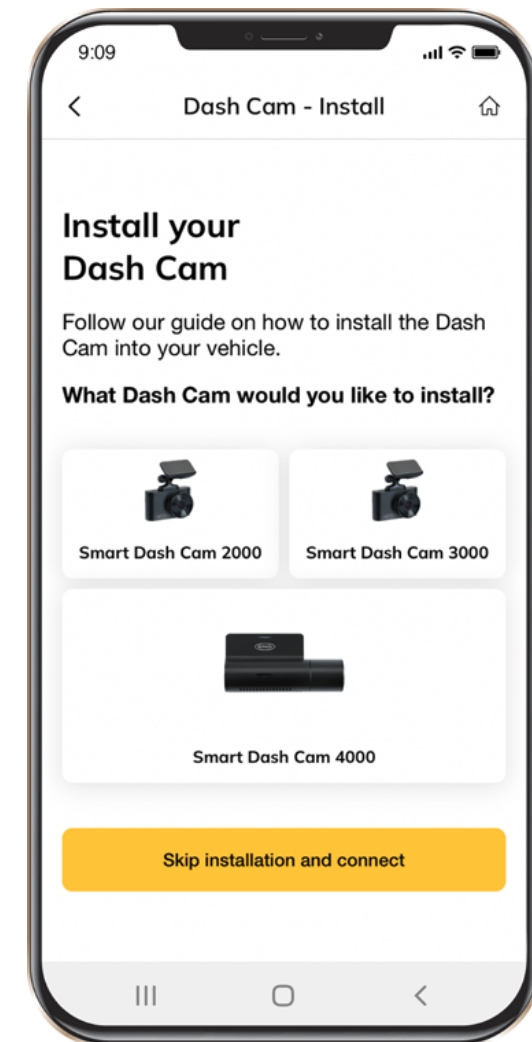



MANCATA FOTOGRAFIA/ REGISTRAZIONE VIDEO

Controllare se c'è abbastanza spazio libero sulla scheda microSD.

LA REGISTRAZIONE È STATA INTERROTTA

Troppi file video memorizzati. Utilizzare solo schede microSD ad alta velocità che siano almeno di classe 10 U1 di produttori affermati.

Quando si tenta di visualizzare una foto/riprodurre un file video, viene visualizzato il messaggio "file sbagliato".

Errore di scrittura del file a causa di un errore del file system della scheda microSD. Formattare la scheda microSD.

IMMAGINE SFOCATA

Assicurarsi che sia stato rimosso l'adesivo dall'obiettivo. Verificare se è presente dello sporco sulla lente. Se presente, pulire l'obiettivo con un panno morbido prima dell'uso (si consiglia di utilizzare prodotti per la cura speciale dell'ottica per non danneggiare la superficie dell'obiettivo).



CHIUDI CHIAMATA

(NESSUNA IMMAGINE, NESSUNA RISPOSTA DEI PULSANTI)

Premere il pulsante RESET nella App per riavviare il dispositivo.

Scheda MicroSD non riconosciuta se utilizzata nella Ring Smart Dash Cam 4000 **

Si prega di formattare la scheda *

















- 1 Verificare che le schede MicroSD siano inserite correttamente nella dashcam
- 2 Collegare la dashcam all'APP RINGconnect
- 3 Una volta collegata la dashcam all'APP, selezionare le impostazioni 'COG ICON'
- 4 Selezionare l'opzione FORMATTA
- 5 Selezionare YES per eseguire la funzione FORMATTA sulla scheda MicroSD

* La funzione Formatta scheda MicroSD eliminerà tutte le informazioni e le registrazioni dalla scheda MicroSD

** La dashcam emetterà un segnale acustico costante se la scheda non viene riconosciuta e deve essere formattata. Nota: se viene utilizzata una scheda micro SD di dimensioni superiori a 32 GB, è necessario l'ultimo aggiornamento del firmware.

CARATTERISTICHE



Ring Smart Dash Cam 4000	1440p 	140° 	≤128 GB* 	≤20 HRS* 	Wi-Fi	GPS
Ring Smart Dash Cam 3000	1296p 	130° 	≤64 GB* 	≤12 HRS* 	Wi-Fi	GPS
Ring Smart Dash Cam 2000	1080p 	120° 	≤32 GB* 	≤6 HRS* 	Wi-Fi	
Ring Dash Cam 1000	720p 	110° 	≤32 GB* 	≤3 HRS* 		

* Full HD a 30 FPS.

** Il tempo di registrazione massimo dipende dalla risoluzione dello schermo, dalle dimensioni della scheda di memoria e dal collegamento della fotocamera posteriore.



REQUISITI DI ALIMENTAZIONE



ATTENZIONE! Se non è presente un'alimentazione esterna, la batteria non può supportare la registrazione per un lungo periodo, assicurarsi che l'alimentazione sia collegata durante la registrazione.

Tensione di ingresso: 5 V CC, 1,5 A.

Tensione di ingresso di ricarica: 12-24 V CC

Connessione mini USB per l'alimentazione

TEMPERATURE DI FUNZIONAMENTO (tutti i modelli)

Temperatura di immagazzinamento: da -20 °C a 70 °C

Temperatura d'esercizio: da -10 a +60 °C

RICICLARE LE BATTERIE USATE



Le batterie non devono essere smaltite nei rifiuti urbani indifferenziati, ma raccolte separatamente per facilitare il corretto trattamento e riciclaggio delle sostanze in esse contenute. Il riciclaggio delle batterie garantisce il recupero di questi preziosi materiali e previene eventuali effetti potenzialmente dannosi sia sull'ambiente che sulla salute umana.



Ring Smart Dash Cam 4000

Dashcam HD 1296p

Dutch

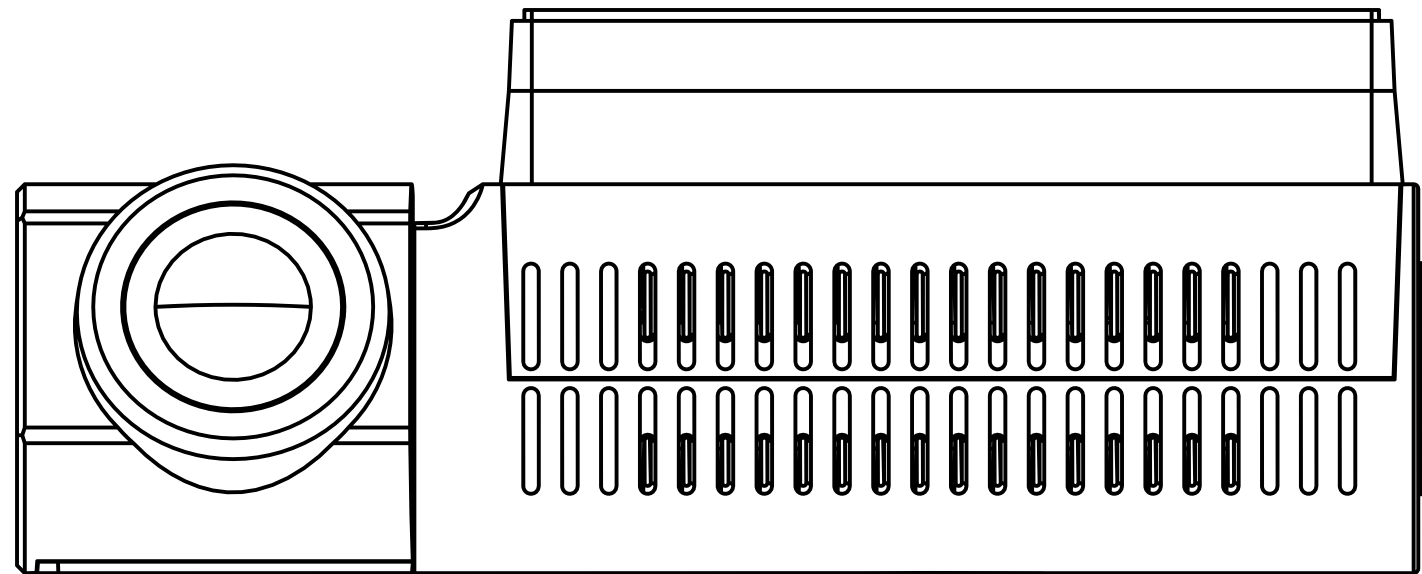

WAARSCHUWING



- 1** Individuele speciale vereisten en wetgeving van de landen moeten in acht worden genomen, vooral met betrekking tot de duur van de registratie/het gebruik en de overdracht van gegevens. Maak uzelf vertrouwd met de gegevensbeschermingswetten van uw land en zorg ervoor dat u deze naleeft. Maak uzelf ook vertrouwd met en houd u aan de relevante wet- en regelgeving met betrekking tot het gebruik en eigendom van dashcamera's in uw land.

DE/AT: Permanente en gelegenhedsvrije opnames zijn niet toegestaan, d.w.z. geen opname van de hele route, kentekenplaten of vreemden (zogenaamde loop-functie). Bij het vastleggen van een gebeurtenis, bijvoorbeeld een ongeval, moeten alle betrokken partijen worden geïnformeerd over de opname en over de overdracht ervan aan de politie. Geen plaatsing van opnames in openbare media (internet, sociale media) zonder toestemming van alle betrokken personen of alleen na vermomming van de personen en kentekenplaten. Het moet onmogelijk zijn om conclusies over personen te trekken, bijvoorbeeld door middel van omgevingsafbeeldingen.
- 2** De dashcam mag niet op een plaats worden gemonteerd die het zicht van de bestuurder op de weg voor zich belemmert.
- 3** Gebruik alleen de meegeleverde voedingsadapter, anders kan de dashcam beschadigd raken. Wees voorzichtig bij het schoonmaken van de dashcam-lens en gebruik alleen een geschikte lensreiniger en een zachte doek. Stel dit product in geen geval bloot aan regen, vocht of water; Als u dit wel doet, bestaat er gevaar voor elektrische schokken of brand. Voer **GEEN** ander onderhoud uit dan beschreven in de instructiehandleiding, tenzij u hiervoor gekwalificeerd bent. Plaats het apparaat bij montage in een voertuig altijd stevig tegen de voorruit en verberg waar mogelijk de voedingskabel onder de interieurbekleding van het voertuig. Zorg ervoor dat de voedingskabel de bedieningselementen van de bestuurder, zoals het stuur, de pedalen of de versnellingspook, niet hindert. Monteer de dashcam **NIET** vóór het opklappen van een airbag of in een positie waarin de binnenspiegels worden bedekt. Werk **NIET** tijdens het rijden en pas instellingen aan of bekijk opnames alleen terwijl u niet rijdt.

VOORDAT U BEGINT

Als u de app nog niet hebt gedownload, doe dit dan nu om het meeste uit uw dashcamera te halen.

- 1 Download de app door te zoeken naar RINGconnect in de App Store (iPhone) of Google Play (Android).
- 2 Open de app, volg het getoonde installatieproces en schakel alle benodigde instellingen in wanneer daarom wordt gevraagd.

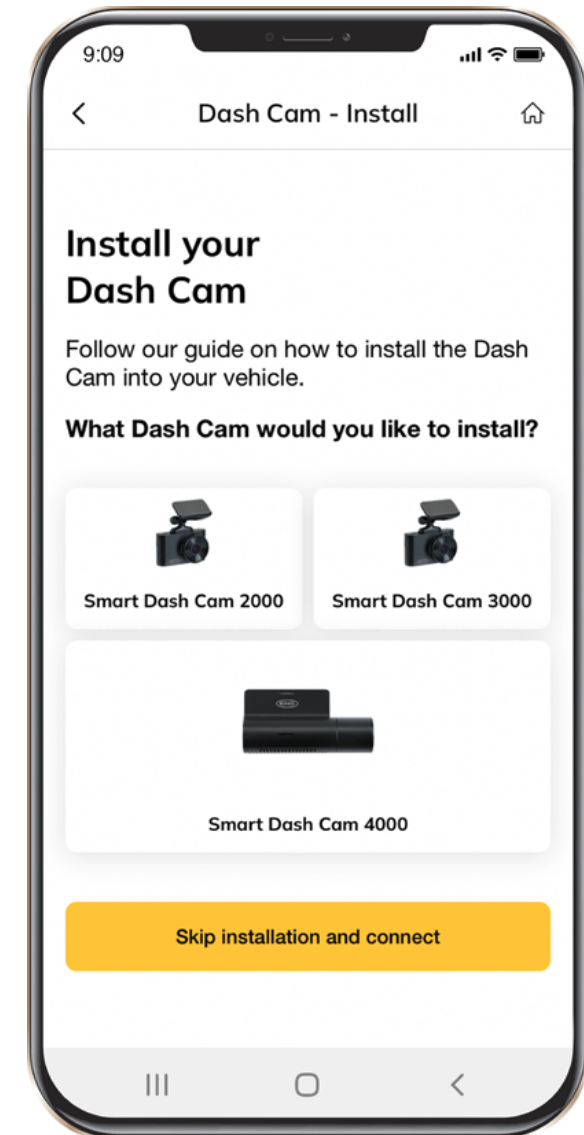
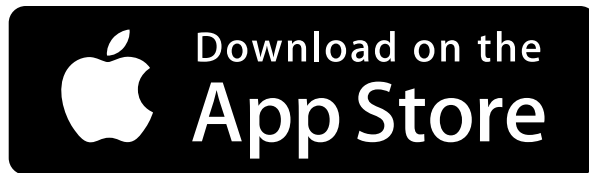



INHOUD VAN DE VERPAKKING

- 1 Dashcam
- 2 Snelstartgids
- 3 Magnetische houder
- 4 USB-oplaadkabel
- 5 Gereedschap voor het verwijderen van afwerkstukjes
- 6 Raamsticker

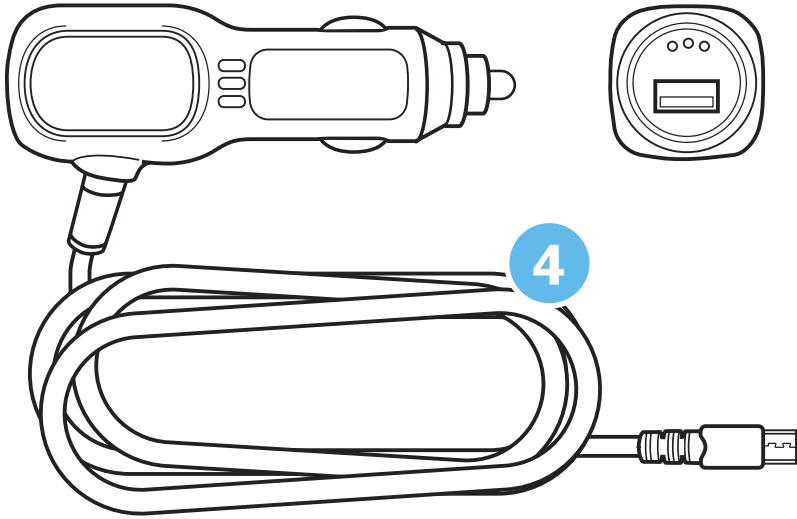
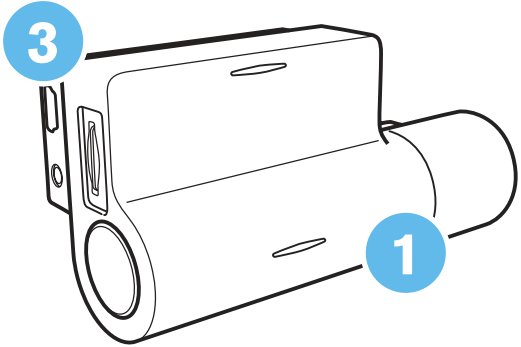
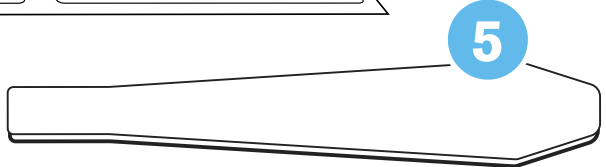
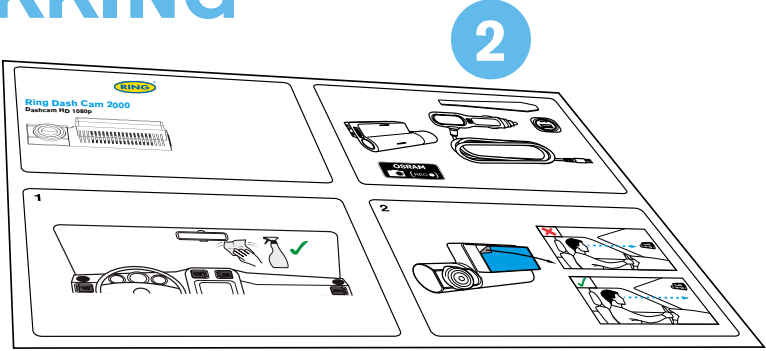



LET OP! Kies van tevoren de montageplaats, want de plaktape op de houder is voor eenmalig gebruik.

- 1** Zorg ervoor dat het glas vuil-, stof- en vetvrij is.
- 2** Warm zelfklevend kussentje van de houder in de handen dient om een sterke hechting op glas te garanderen.
- 3** Zodra de houder is gepositioneerd, sluit u de dashcamera aan op de magnetische houder.

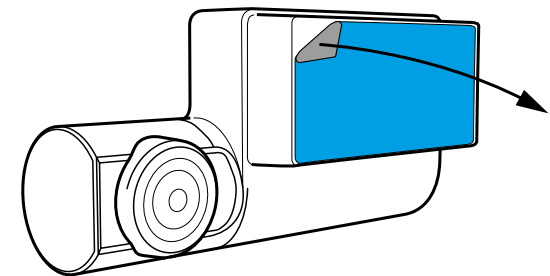
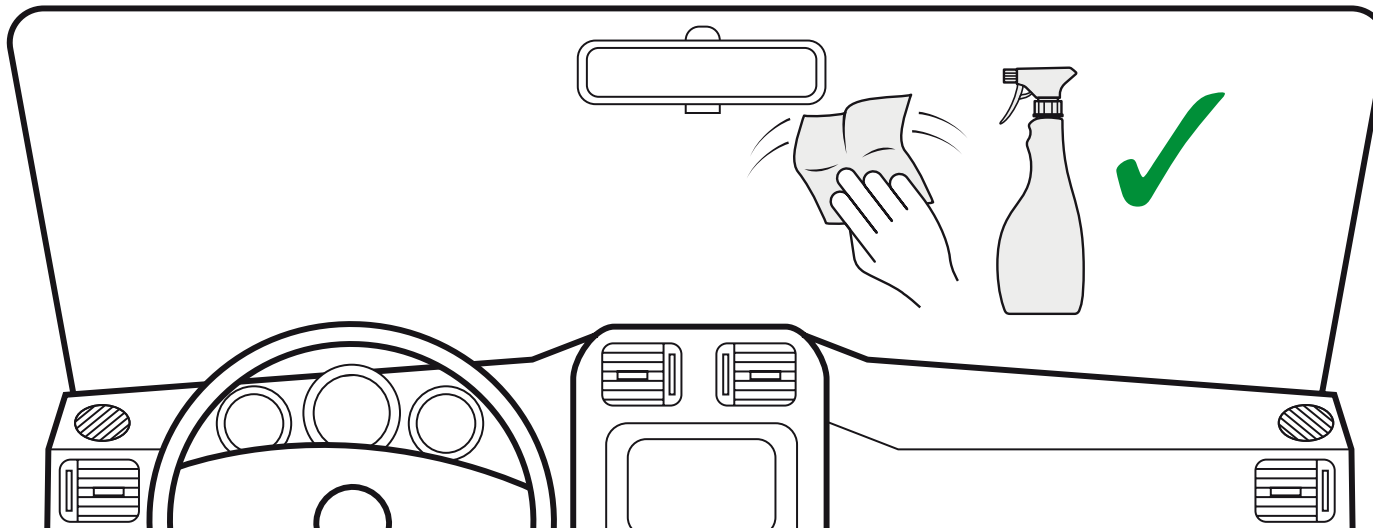



Gebruik alleen de meegeleverde voedingsadapter om het apparaat van stroom te voorzien en de batterij op te laden. Sluit de voedingskabel aan op de houder en sluit de USB-oplader aan op de 12V-aansluiting van de auto.

Wanneer de motor van het voertuig start, wordt het apparaat automatisch ingeschakeld.

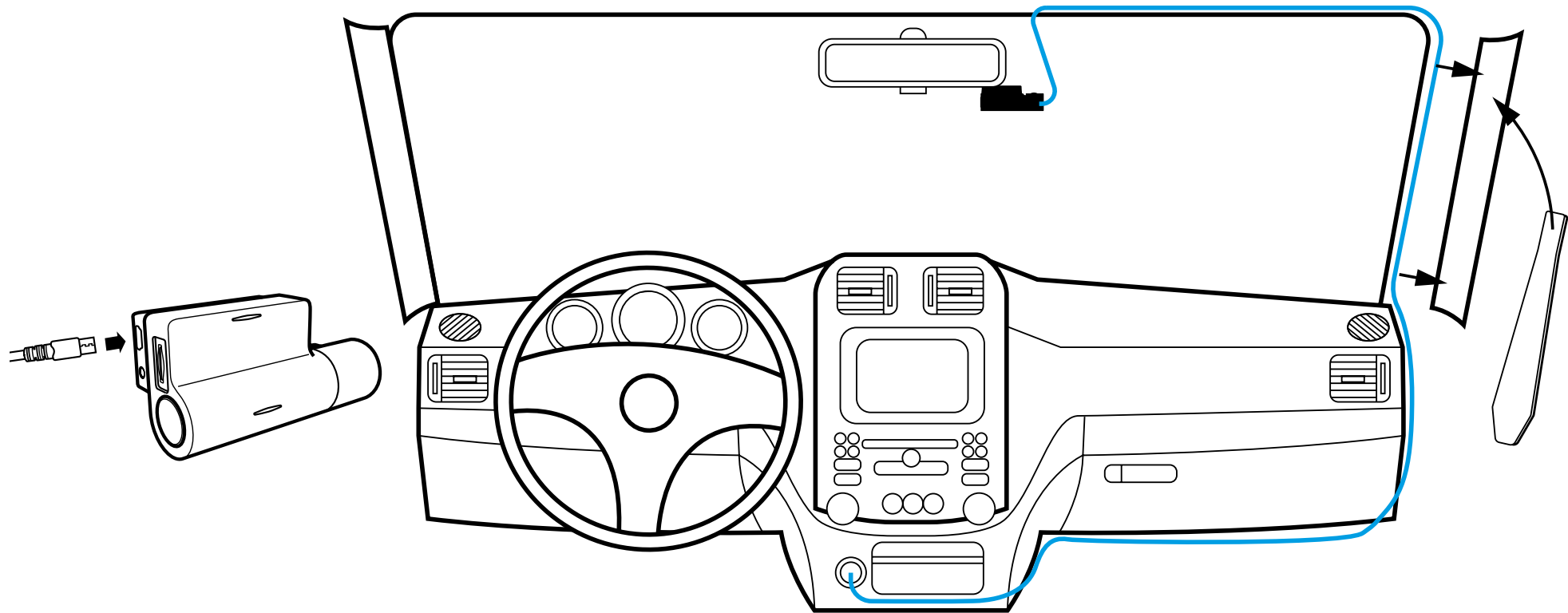

DE microSD-KAART INSTALLEREN

- 1** Zorg ervoor dat het apparaat is uitgeschakeld voordat u een geheugenkaart installeert.
- 2** Plaats de geheugenkaart totdat deze op zijn plaats klikt.
- 3** Verwijderen van een kaart: druk licht op de kaart en verwijder deze vervolgens uit de sleuf.

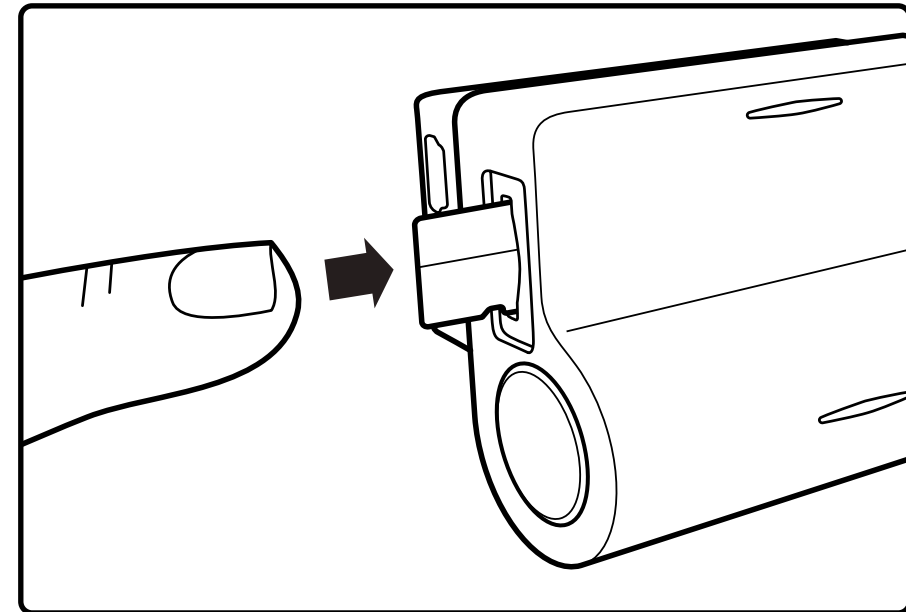

WAARSCHUWING! Oefen geen overmatige kracht uit bij het plaatsen van een geheugenkaart om schade aan het apparaat te voorkomen. Gebruik indien nodig een dun puntig apparaat om de kaart verder te duwen. Om de geheugenkaart te verwijderen, drukt u op de kaart totdat deze vastklikt en verwijdert u de kaart uit de sleuf.

IN-/UITSCHAKELEN



- Wanneer het contact van het voertuig wordt ingeschakeld, wordt de dashcam automatisch ingeschakeld.
- Om het apparaat handmatig in te schakelen, drukt u op de aan/uit-knop.
- Om het apparaat uit te schakelen, houdt u de aan/uit-knop ongeveer 2 seconden ingedrukt. 3 seconden.

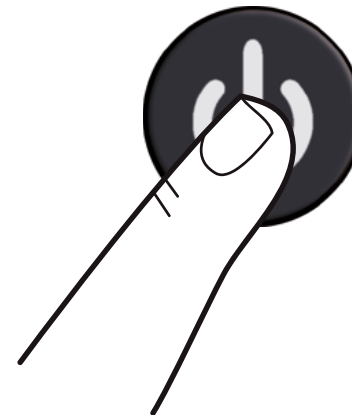
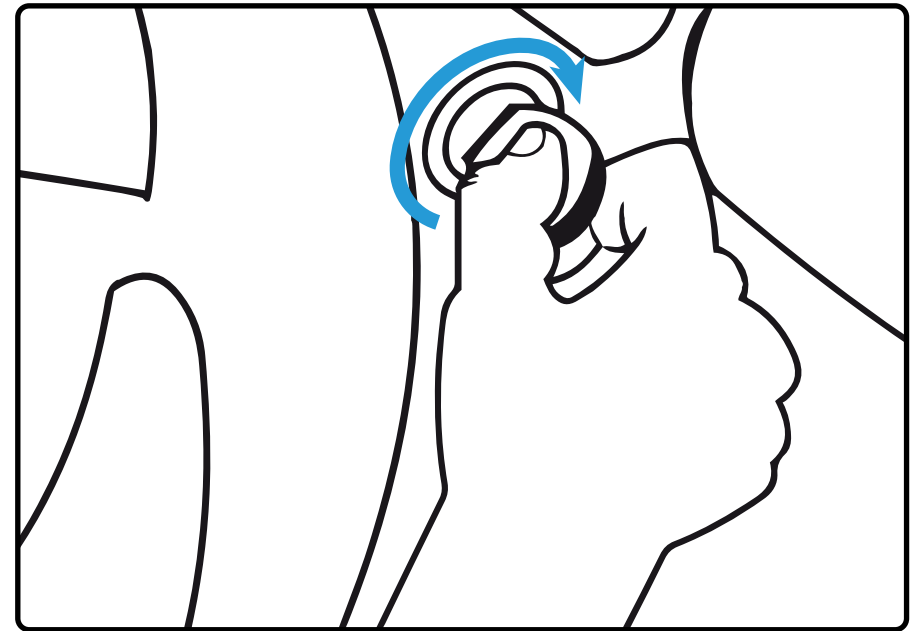



MET MOBIEL VERBINDEN

- 1** Schakel de dashcam in.
- 2** Uw camera zendt automatisch een wifi-netwerk uit.
- 3** Open de instellingen van uw telefoon.
- 4** Tik op Wifi-verbindingen.
- 5** Selecteer de hotspot voor de dashcam en voer het wachtwoord "12345678" in.
- 6** U bent nu verbonden met uw apparaat.

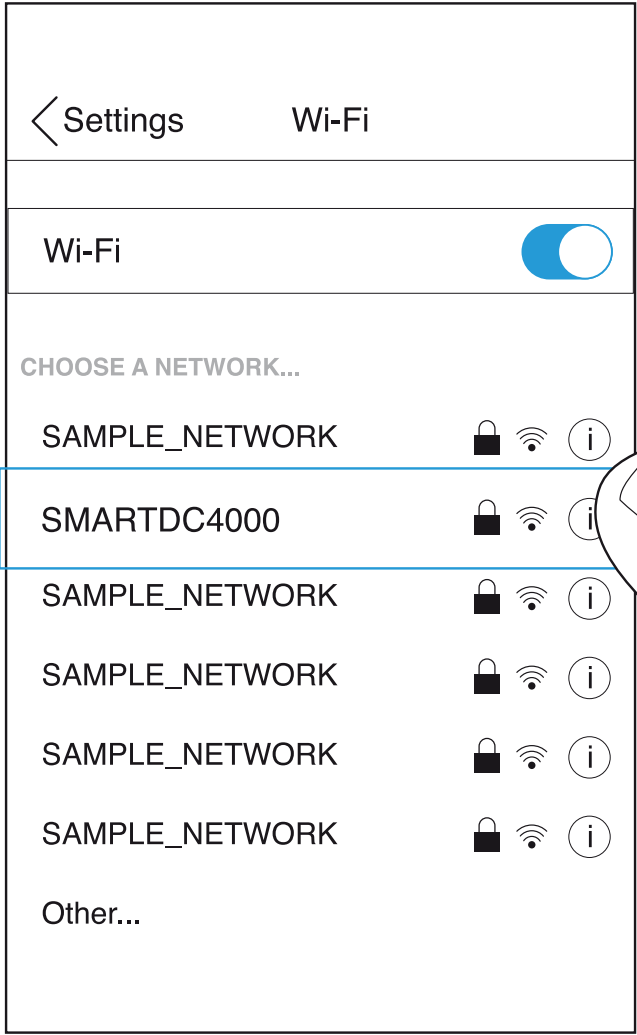
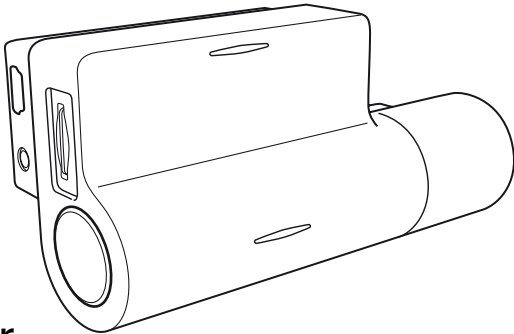

DE KIJKHOEK AANPASSEN



LET OP! Het aanpassen van de kijkhoek is alleen mogelijk langs de verticale as, dus zorg ervoor dat u het apparaat correct op de voorruit plaatst langs de horizontale as, zo dicht mogelijk bij het midden van de voorruit.

Terwijl u het apparaat in de houder trekt of duwt, moet u ervoor zorgen dat de camera het beeld vastlegt in een verhouding van 30% lucht / 70% weg.

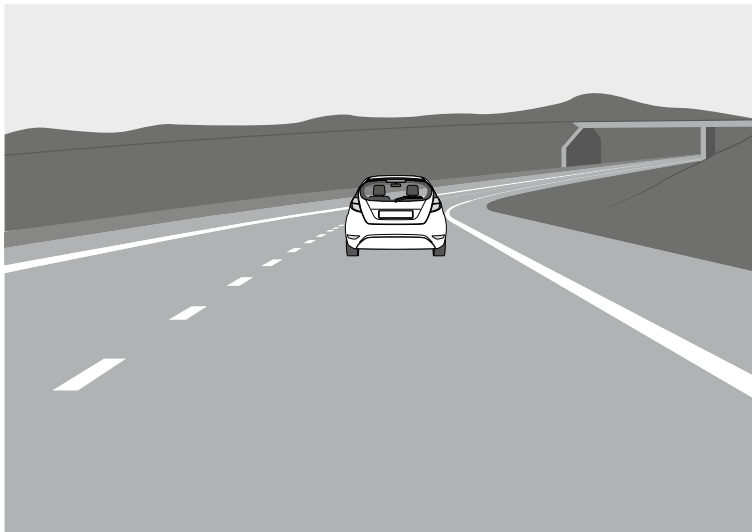

Goed

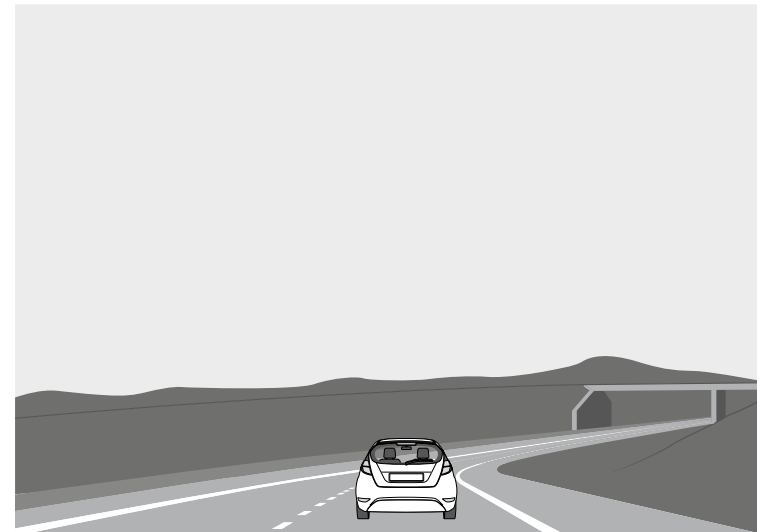

Slecht

MENU-INSTELLINGEN

Om toegang te krijgen tot de menu-instellingen, drukt u op de knop "Instellingen"; in het hoofdmenu.

Videokwaliteit: selecteer de gewenste optie (de hoogste optie biedt optimale kijkprestaties).

Beeldresolutie: 1-12 megapixels

Lus-opname: 1, 3 of 5 minuten

Datumstempel: UIT/AAN

Audio opnemen: UIT/AAN

Parkeermonitor: UIT/AAN

G-sensor: UIT/LAAG/GEMIDDELD/HOOG

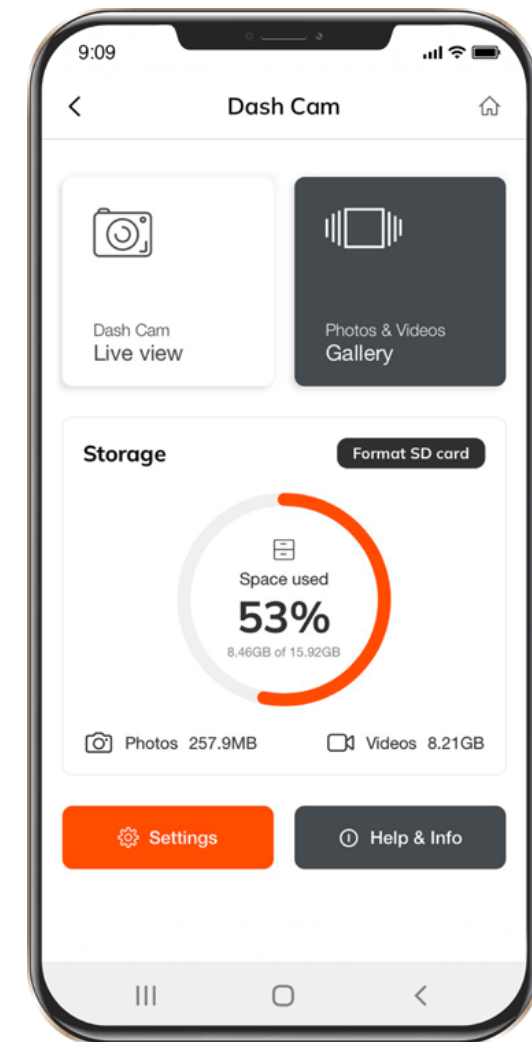

NOODOPNAME

- 1** Noodopname is bedoeld om te voorkomen dat het huidige videobestand wordt overschreven en verwijderd.
- 2** Noodopname wordt automatisch geactiveerd wanneer de G-sensor wordt geactiveerd (bij plotselinge versnelling/vertraging) of op het moment van een botsing. Noodopname wordt automatisch vergrendeld om het wissen tijdens lus-opname te voorkomen.

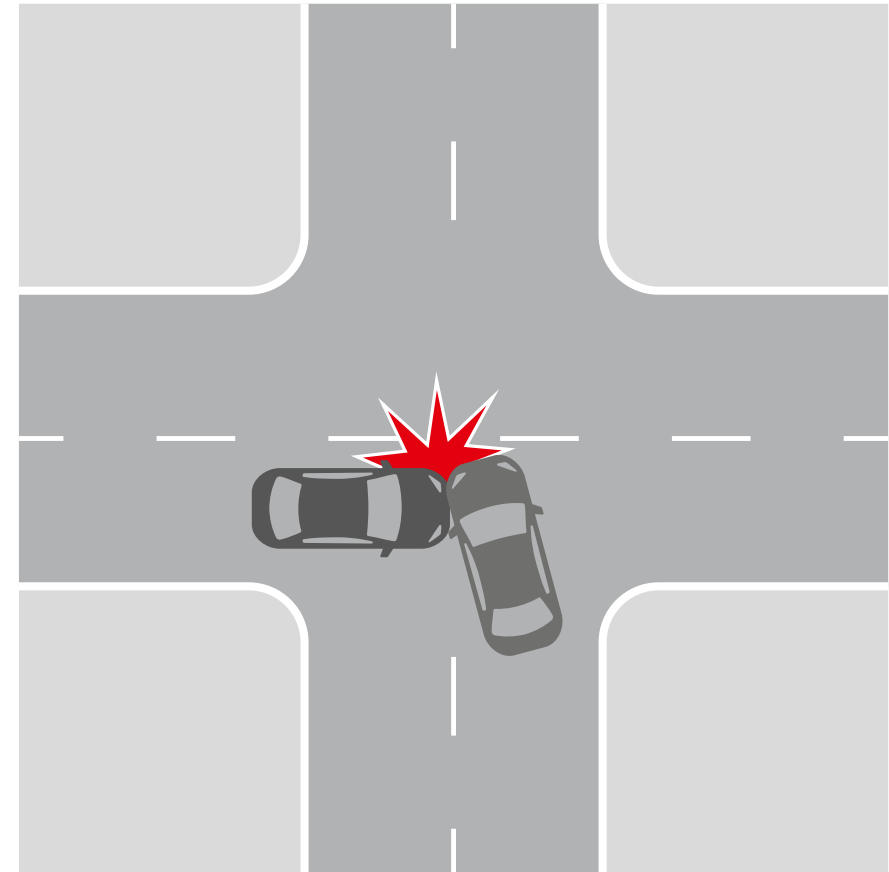

OPNAME AF SPELEN

- 1 Om het afspeelmenu te openen, drukt u op de albumknop op het hoofdscherm.
- 2 Menu Video en afbeelding.
 - Selecteer tegels van video's of afbeeldingen om te bekijken.



VIDEOMENU

- 1 Druk eenmaal kort op elk videobestand om het afspeelmenu te openen.
- 2 Houd elk videobestand 3 seconden ingedrukt om het submenu van de video te openen. Van daaruit kunt u de geselecteerde video vergrendelen, downloaden, delen of verwijderen.

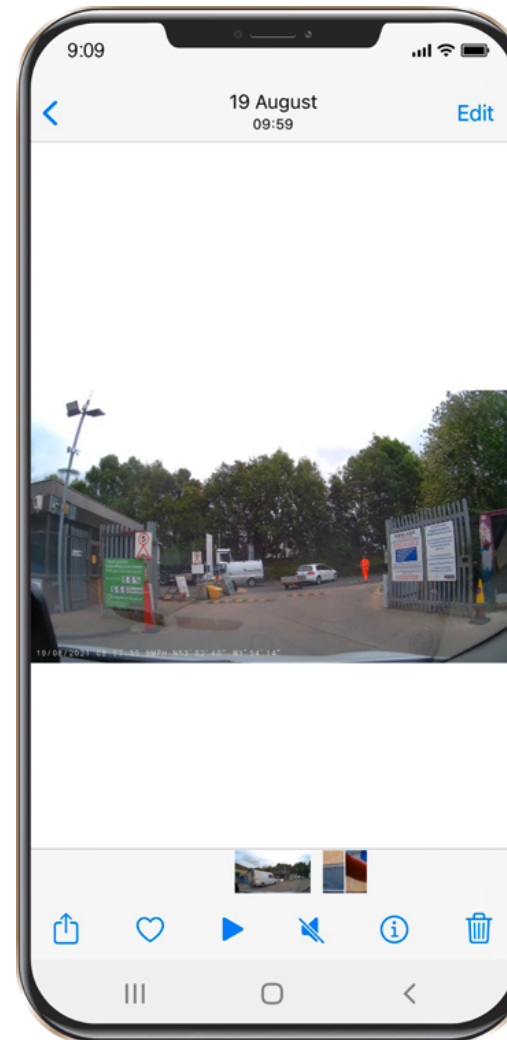



MENU AFBEELDING

- 1 Druk eenmaal kort op elk videobestand om het afspeelmenu te openen.
- 2 Houd elk videobestand 3 seconden ingedrukt om het submenu van de video te openen. Van daaruit kunt u de geselecteerde video vergrendelen, downloaden, delen of verwijderen.

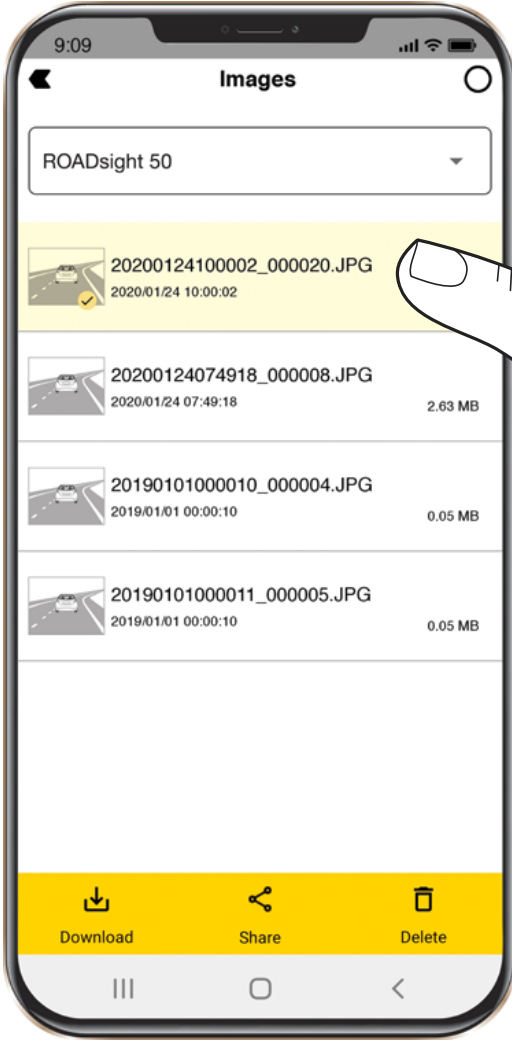

MENU VEELGESTELDE VRAGEN

Om het menu Veelgestelde vragen te openen, drukt u op het vervolgkeuzemenu en selecteert u Veelgestelde vragen.

Veeg omhoog of omlaag om alle veelgestelde vragen te zien.

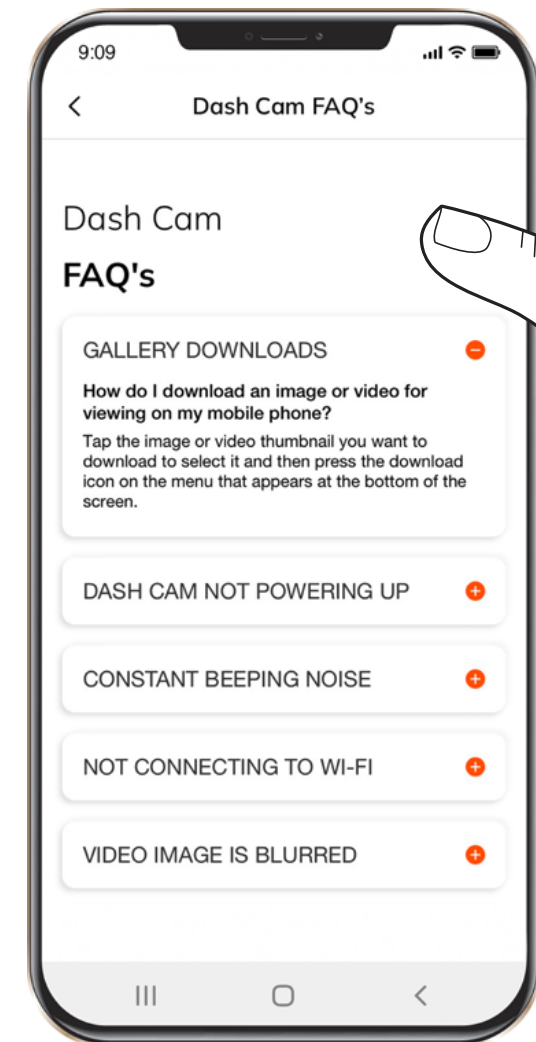

MENU INSTALLATIEGIDS



- 1 Om het menu Installatiehandleiding te openen, drukt u op het vervolgkeuzemenu en selecteert u Installatiegids.
- 2 Er verschijnt nog een vervolgkeuzemenu. Selecteer de dashcam die wordt gebruikt in het vervolgkeuzemenu.





FOTO / VIDEO OPNEMEN MISLUKT

Controleer of er voldoende vrije ruimte is op de micro SD-kaart.

DE OPNAME IS GESTOPT

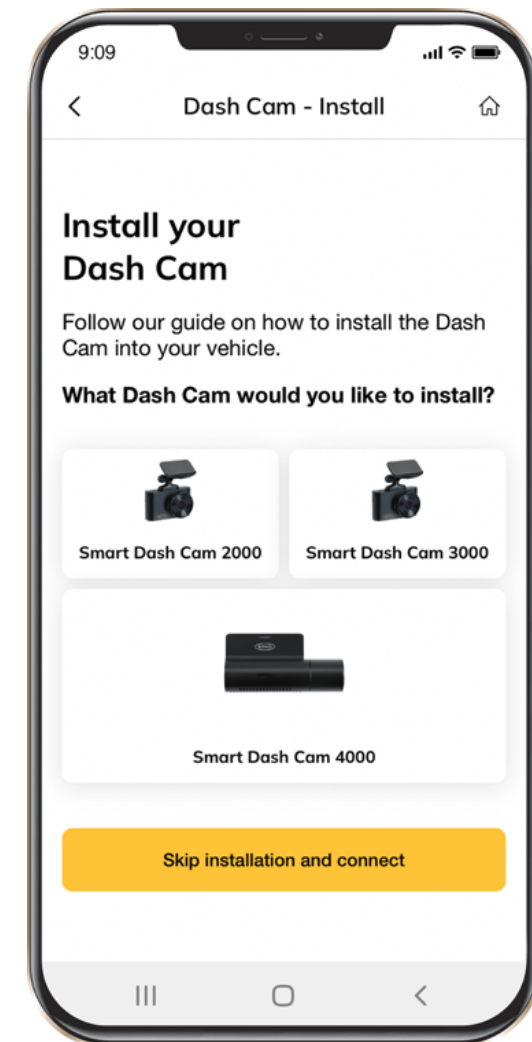
Er zijn te veel videobestanden opgeslagen. Gebruik minimaal klasse 10 U1 high-speed micro SD-kaarten van deugdelijk gebleken producenten.

Wanneer u een foto probeert te bekijken/een videobestand probeert af te spelen, wordt het bericht "verkeerde bestand" weergegeven.

Fout bij het schrijven van bestanden vanwege een fout in het bestandssysteem van de micro SD-kaart. Formateer de micro SD-kaart.

WAZIG BEELD

Zorg ervoor dat de lenssticker is verwijderd. Controleer of er vuil op de lens zit. Als dat het geval is, veeg de lens dan voor gebruik af met een zachte doek (het wordt aanbevolen om speciale verzorgingsproducten voor de optiek te gebruiken om het oppervlak van de lens niet te beschadigen).

VASTLOPEN VAN APPARAAT (GEEN BEELD, GEEN KNOPRESPONS)



Druk op de RESET-knop om het apparaat opnieuw op te starten.

MicroSD-kaart niet herkend bij gebruik in Ring Smart Dash Cam 4000 **

Formateer de kaart *

















- 1** Zorg ervoor dat de MicroSD-kaarten correct in de dashcam zijn geplaatst
- 2** Verbind de dashcam met de RINGconnect-app
- 3** Zodra de dashcam is verbonden met de app, selecteert u de instellingen 'COG ICON'
- 4** Selecteer de optie FORMATTEREN
- 5** Selecteer JA om de MicroSD-kaart te FORMATTEREN

* Als u een MicroSD-kaart formateert, worden alle gegevens en opnamen van de MicroSD-kaart verwijderd

** De dashcam laat een constant piepgeluid horen als de kaart niet wordt herkend en moet worden geformatteerd. Let op: als een micro SD-kaart groter dan 32 GB wordt gebruikt, is de laatste firmware-update vereist.

KENMERKEN



Ring Smart Dash Cam 4000	1440p 	140° 	≤128 GB* 	≤20 HRS* 	Wi-Fi	GPS
Ring Smart Dash Cam 3000	1296p 	130° 	≤64 GB* 	≤12 HRS* 	Wi-Fi	GPS
Ring Smart Dash Cam 2000	1080p 	120° 	≤32 GB* 	≤6 HRS* 	Wi-Fi	
Ring Dash Cam 1000	720p 	110° 	≤32 GB* 	≤3 HRS* 		

* Full HD bij 30 FPS.

** De maximale opnametijd is afhankelijk van de schermresolutie, geheugenkaartgrootte en bevestiging van de camera aan de achterzijde.

STROOMVEREISTEN



LET OP! Als er geen externe voedingsingang is, kan de batterij lange tijd geen opname ondersteunen. Zorg ervoor dat de voeding is aangesloten tijdens het opnemen.

Ingangsspanning: 5V DC, 1.5A

Laadingangsspanning: 12-24V DC

Mini USB-aansluiting voor stroomvoorziening

BEDRIJFSTEMPERATUREN (alle modellen)

Opslagtemperatuur: -20 ° C tot 70 ° C

Bedrijfstemperatuur: -10 ° C tot 60 ° C

RECYCLE UW GEBRUIKTE BATTERIJEN



Batterijen mogen niet bij het ongesorteerde huisvuil worden weggegooid, maar moeten apart worden ingezameld om de juiste behandeling en recycling van de stoffen die ze bevatten, te vergemakkelijken. Het recyclen van batterijen zorgt voor het terugwinnen van deze waardevolle materialen en voorkomt mogelijke schadelijke effecten op zowel het milieu als de menselijke gezondheid.