

User Guide

High-efficiency wall-hung condensing gas boiler

424 Combi 2 - 430 Combi 2
424 Combi LPG 2 - 430 Combi LPG 2

Dear Customer,

Thank you very much for buying this appliance.

Please read through the manual carefully before using the product, and keep it in a safe place for later reference. In order to ensure continued safe and efficient operation we recommend that the product is serviced regularly. Our service and customer service organisation can assist with this.

We hope you enjoy years of problem-free operation with the product.

Contents

1	Safety	5
1.1	General safety instructions	5
1.2	Recommendations	6
1.2.1	The Benchmark scheme	6
1.2.2	Benchmark commissioning checklist	6
1.3	Liabilities	7
1.3.1	User's liability	7
1.3.2	Installer's liability	7
1.3.3	Manufacturer's liability	7
2	About this manual	8
2.1	General	8
2.2	Additional documentation	8
2.3	Symbols used	8
2.3.1	Symbols used in the manual	8
2.4	Abbreviations/glossary	8
3	Technical specifications	9
3.1	Homologations	9
3.1.1	Certification	9
3.2	Technical data	9
3.2.1	Technical information	9
3.2.2	Dimensions and connections/clearances	11
4	Description of the product	12
4.1	General description	12
4.2	Operating principle	12
4.2.1	Air-gas adjustment	12
4.2.2	Combustion	12
4.2.3	Heating and domestic hot water production	12
4.3	Control panel description	13
4.3.1	Description of the keys and knobs	13
4.4	Accessories & options	13
5	Operation	14
5.1	Start-up	14
5.1.1	Procedure for first start-up	14
5.1.2	Changing the heating flow temperature	14
5.1.3	Changing the domestic hot water (DHW) temperature	14
5.2	Shutdown	15
5.2.1	Switching off the heating and domestic water (DHW)	15
5.3	Frost protection	15
6	Settings	16
6.1	Access to USER parameters	16
6.2	List of USER parameters	16
7	Maintenance	18
7.1	General	18
7.2	Maintenance instruction	18
7.2.1	Filling the installation	18
7.2.2	Venting the installation	19
7.3	Maintenance message	19
8	Troubleshooting	20
8.1	Temporary and permanent faults	20
8.2	Error codes	20
8.3	Fault finding	25

9	Decommissioning	26
9.1	Decommissioning procedure.	26
10	Disposal	27
10.1	Disposal and recycling	27
11	Environmental	28
11.1	Energy saving	28
11.2	Room thermostats and settings.	28
12	Warranty	29
12.1	General	29
12.2	Standard warranty terms and conditions	29
13	Appendix	31
13.1	Product fiche - Combination boilers.	31
13.2	Package fiche - boilers	32
13.3	Package fiche - Combination heaters (boilers or heat pumps)	34

1 Safety

1.1 General safety instructions

Fig.1 Taps ON and OFF

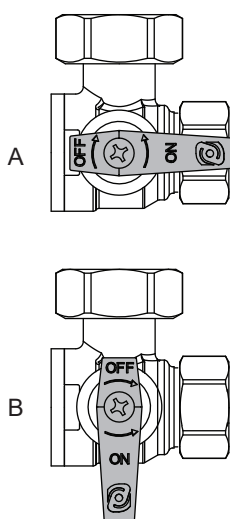

PN-0000367



Danger

This boiler can be used by children aged 8 years and above and by persons with reduced physical, sensory or mental capabilities or lack of experience and knowledge when they have been given supervision or instruction concerning the safe use of the device and understand the resulting risks. Children must not be allowed to play with the appliance. Cleaning and user maintenance must not be carried out by children without supervision.



Danger

If you smell gas:

1. Turn off the gas supply at the meter.
2. Open windows and doors in the hazardous area.
3. Do not operate light switches.
4. Do not operate any electrical equipment.
5. Do not use a telephone in the hazardous area.
6. Extinguish any naked flame and do not smoke.
7. Warn any other occupants and vacate the premises.
8. Telephone the National Gas Emergency Service on:- 0800 111 999.



Important

If a water or gas leak occurs or is suspected, the boiler can be isolated at the inlet valves by turning their taps through 90° (1/4 turn) downwards.

- | | |
|---|-----|
| A | ON |
| B | OFF |

For advice please contact your Installer, Annual Service Provider or **Baxi Customer Support** - The Service Division of Baxi. You can contact **Baxi Customer Support** on telephone number **0344 871 1545**.

When contacting **Baxi Customer Support** it will be useful to have the "**Benchmark Checklist**" at the back of the Installation & Service Manual to hand as it includes details relevant to the boiler and installation.



Warning

Do not touch flue/chimney pipes. Depending on the settings of the appliance, the temperature of flue/chimney pipes may exceed 60 °C.

Do not touch radiators for long periods. Depending on the settings of the appliance, the temperature of radiators may reach 85 °C.

Take precautions with domestic hot water. Depending on the settings of the appliance, domestic hot water temperature may reach 65 °C.



Caution

Do not neglect to service the appliance. Contact a qualified professional or take out a maintenance contract for the annual servicing of the appliance.

1.2 Recommendations



Caution

- Only qualified professionals are authorised to work on the boiler and the installation.
- The appliance has an integral frost protection mode as long as there is power to the boiler.



Important

- Regularly check the water pressure in the system (recommended pressure is 1.5 bar).
- Keep the appliance accessible at all times.
- Do not remove or cover the user information and serial number labels affixed to the boiler control flap. They must remain legible throughout the lifetime of the boiler.

1.2.1 The Benchmark Scheme

Baxi Heating UK Ltd is a licensed member of the Benchmark Scheme which aims to improve the standards of installation and commissioning of domestic heating and hot water systems in the UK and to encourage regular servicing to optimise safety, efficiency and performance.

Benchmark is managed and promoted by Heating and Hotwater Industry Council. For more information visit www.centralheating.co.uk

1.2.2 Benchmark Commissioning Checklist

Please ensure that the installer has fully completed the Benchmark Checklist on the inside back pages of the installation instructions supplied with the product and that you have signed it to say that you have received a full and clear explanation of its operation. The installer is legally required to complete a commissioning checklist as a means of complying with the appropriate Building Regulations (England and Wales).

All installations must be notified, by the installer, to Local Area Building Control either directly or through a Competent Persons Scheme. A Building Regulations Compliance Certificate will then be issued to the customer who should, on receipt, write the Notification Number on the Benchmark Checklist.

This product should be serviced annually to optimise its safety, efficiency and performance. The service engineer should complete the relevant section of the Benchmark Service Record in the Installation & Service manual after each service.

The completed Benchmark Checklist & proof of annual servicing (where applicable) will be required in the event of any warranty work.

1.3 Liabilities

1.3.1 User's liability

To guarantee optimum operation of the system, you must abide by the following instructions:

- Read and follow the instructions given in the manuals provided with the appliance.
- Call on a qualified professional to carry out installation and initial commissioning.
- Get your installer to explain your installation to you.
- Have the required inspections and maintenance carried out by a qualified installer.
- Keep the instruction manuals in good condition close to the appliance.

1.3.2 Installer's liability

The installer is responsible for the installation and initial commissioning of the appliance. The installer must observe the following instructions:

- Read and follow the instructions given in the manuals provided with the appliance.
- Install the appliance in compliance with prevailing legislation and standards.
- Carry out initial commissioning and any checks necessary.
- Explain the installation to the user.
- If maintenance is necessary, warn the user of the obligation to check the appliance and keep it in good working order.
- Give all the instruction manuals to the user.

1.3.3 Manufacturer's liability

Our products are manufactured in compliance with the requirements of the various Directives applicable. They are therefore delivered with the  marking and any documents necessary. In the interests of the quality of our products, we strive constantly to improve them. We therefore reserve the right to modify the specifications given in this document.

Our liability as manufacturer may not be invoked in the following cases:

- Failure to abide by the instructions on installing and maintaining the appliance.
- Failure to abide by the instructions on using the appliance.
- Faulty or insufficient maintenance of the appliance.

2 About this manual

2.1 General



Warning

Installation, repair and maintenance must only be carried out only by a competent person.

All Gas Safe registered engineers carry an ID card with their licence number and a photograph. You can check your engineer is registered by telephoning 0800 408 5500 or online at www.gassaferegister.co.uk

This manual is intended for the user of the Baxi 400 Combi 2 boiler. If the appliance is sold or transferred, or if the owner moves leaving the appliance behind you should ensure that the manual is kept with the appliance for consultation by the new owner and their installer.

The appliance is designed as a boiler for use in residential domestic environments on a governed meter supply only. The selection of this boiler is entirely at the owner's risk. If the appliance is used for purposes other than or in excess of these specifications, the manufacturer will not accept any liability for resulting loss, damage or injury.

The manufacturer will not accept any liability whatsoever for loss, damage or injury arising as a result of failure to observe the instructions for use, maintenance and installation of the appliance.

2.2 Additional documentation

Various timers, external controls, etc. are available as optional extras. Full details are contained in the relevant sales literature.

2.3 Symbols used

2.3.1 Symbols used in the manual

This manual uses various danger levels to draw attention to special instructions. We do this to improve user safety, to prevent problems and to guarantee correct operation of the appliance.



Danger

Risk of dangerous situations that may result in serious personal injury.



Danger of electric shock

Risk of electric shock.



Warning

Risk of dangerous situations that may result in minor personal injury.



Caution

Risk of material damage.



Important

Please note: important information.



See

Reference to other manuals or pages in this manual.

2.4 Abbreviations/glossary

CH	Central heating
DHW	Domestic hot water
PCU	PCB for managing burner operation
Pnc	Condensing output
SU	Safety PCB

3 Technical specifications

3.1 Homologations

3.1.1 Certification

Tab.1 Certifications

UKCA certificate number	748363
NOx class	6
Boiler type	C ₁₃ , C ₃₃

3.2 Technical data

3.2.1 Technical information



Important

All data in these sections are nominal and subject to normal production tolerances.

Tab.2 Technical settings for combination heaters with boilers

Baxi Combi 2			424	430	424 LPG	430 LPG
Gas Council numbers			47-077-51	47-077-52	47-077-53	47-077-54
Condensing boiler			Yes	Yes	Yes	Yes
Low-temperature boiler ⁽¹⁾			No	No	No	No
B1 boiler			No	No	No	No
Cogeneration space heater			No	No	No	No
Combination heater			Yes	Yes	Yes	Yes
Rated heat output	<i>Prated</i>	kW	20	20	20	20
Useful heat output at rated heat output and high temperature setting ⁽²⁾	<i>P4</i>	kW	20	20	20	20
Useful heat output at 30% of rated heat out-put and low temperature setting ⁽¹⁾	<i>P1</i>	kW	6.7	6.7	6.7	6.7
Seasonal space heating energy efficiency	<i>ηs</i>	%	93	93	93	93
Useful efficiency at rated heat output and high temperature setting ⁽²⁾	<i>η4</i>	%	88.2	88.0	88.2	88
Useful efficiency at 30% of rated heat output and low temperature setting ⁽¹⁾	<i>η1</i>	%	97.9	97.8	97.9	97.8
Auxiliary electricity consumption						
Full load	<i>elmax</i>	kW	0.037	0.026	0.037	0.026
Partial load	<i>elmin</i>	kW	0.014	0.014	0.014	0.014
Standby mode	<i>PSB</i>	kW	0.004	0.004	0.004	0.004
Other items						
Heat loss on standby	<i>Pstby</i>	kW	0.04	0.04	0.04	0.04
Ignition burner power consumption	<i>Pign</i>	kW	-	-	-	-
Annual energy consumption	<i>QHE</i>	GJ	62	62	62	62
Sound power level, indoors	<i>LWA</i>	dB	50	49	50	49
Nitrogen oxide emissions	NOx	mg/kWh	24	21	21	21
Domestic hot water parameters						
Declared load profile			XL	XL	XL	XL
Daily electricity consumption	<i>Qelec</i>	kWh	0.176	0.189	0.176	0.189
Annual electricity consumption	<i>AEC</i>	kWh	39	42	39	42
Water heating energy efficiency	<i>ηwh</i>	%	88	89	88	89
Daily fuel consumption	<i>Qfuel</i>	kWh	22.03	21.66	22.03	21.66
Annual fuel consumption	<i>AFC</i>	GJ	17	17	17	17
(1) Low temperature means for condensing boilers 30°C, for low temperature boilers 37°C and for other heaters 50°C return temperature (at heater inlet).						
(2) High temperature setting means 60 °C return temperature at boiler inlet and 80 °C flow temperature at boiler outlet						

Tab.3 General

		424	430	424 LPG	430 LPG
Rated heat input (Qn) for domestic hot water	kW	24.7	30	24.7	30
Rated heat input (Qn) with domestic hot water tank	kW	–	-	–	-
Rated heat input (Qn) for heating	kW	20.6	20.6	20.6	20.6
Reduced heat input (Qn) 80/60 °C	kW	4.9	6.0	4.9	6
Rated heat output (Pn) for domestic hot water	kW	24	29.1	24	29.1
Rated heat output (Pn) with domestic hot water tank	kW	–	-	–	-
Rated heat output (Pn) 80/60 °C for heating	kW	20	20	20	20
Rated heat output (Pn) 50/30 °C for heating	kW	21.8	21.8	21.8	21.8
Reduced heat output (Pn) 80/60 °C	kW	4.8	5.8	4.8	5.8
Reduced heat output (Pn) 50/30 °C	kW	5.2	6.3	5.2	6.3
Rated efficiency 50/30 °C (Hi)	%	105.8	105.8	105.8	105.8

Tab.4 Characteristics of the heating circuit

		424	430	424 LPG	430 LPG
Maximum pressure	bar	2.5	2.5	2.5	2.5
Minimum pressure	bar	0.5	0.5	0.5	0.5
Temperature range for heating circuit	°C	25 - 80	25 - 80	25 - 80	25 - 80
Water capacity of expansion vessel	l	7	7	7	7

Tab.5 Characteristics of the domestic water circuit

		424	430	424 LPG	430 LPG
Minimum pressure	bar	0.8	0.8	0.8	0.8
Maximum pressure	bar	8.0	8.0	8	8
Minimum dynamic pressure	bar	0.15	0.15	0.15	0.15
Minimum water flow	l/min	2.0	2.0	2	2
Specific flow (D)	l/min	11.5	14	11.5	14
Temperature range for domestic water circuit	°C	35 - 60	35 - 60	35 - 60	35 - 60
Domestic water production with $\Delta T = 25$ °C	l/min	13.8	16.7	13.8	16.7
Domestic water production with $\Delta T = 35$ °C	l/min	9.8	11.9	9.8	11.9

Tab.6 Combustion characteristics

		424	430	424 LPG	430 LPG
G20 gas consumption (Qmax)	m ³ /h	2.61	3.17	2.61	3.17
G20 gas consumption (Qmax) with domestic hot water tank	m ³ /h	–	-	–	-
G20 gas consumption (Qmin)	m ³ /h	0.52	0.63	0.52	0.63
G31 propane gas consumption (Qmax)	kg/h	–	–	1.92	2.33
G31 propane gas consumption (Qmin)	kg/h	–	–	0.38	0.47
Diameter of separate discharge pipes	mm	80/80	80/80	80/80	80/80
Diameter of coaxial discharge pipes	mm	60/100	60/100	60/100	60/100
Flue gas mass flow rate (max)	kg/sec	0.011	0.014	0.011	0.014
Flue gas mass flow rate (max) with domestic hot water tank	kg/sec	–	-	–	-
Flue gas mass flow rate (min)	kg/sec	0.002	0.003	0.002	0.003

Tab.7 Electrical characteristics

		424	430	424 LPG	430 LPG
Power supply voltage	V	230	230	230	230
Power supply frequency	Hz	50	50	50	50
Rated electric power	W	90	90	90	90
Rated electrical output with domestic hot water tank	W	–	-	–	-

Tab.8 Other characteristics

		424	430	424 LPG	430 LPG
Humidity protection rating (EN 60529)	IP	X5D	X5D	X5D	X5D
Net weight when empty/filled with water	kg	28/30	29/31	28/30	29/31
Dimensions (height/width/depth)	mm	700/395/285	700/395/285	700/395/285	700/395/285

3.2.2 Dimensions and connections/clearances

Fig.2 Dimensions and connections

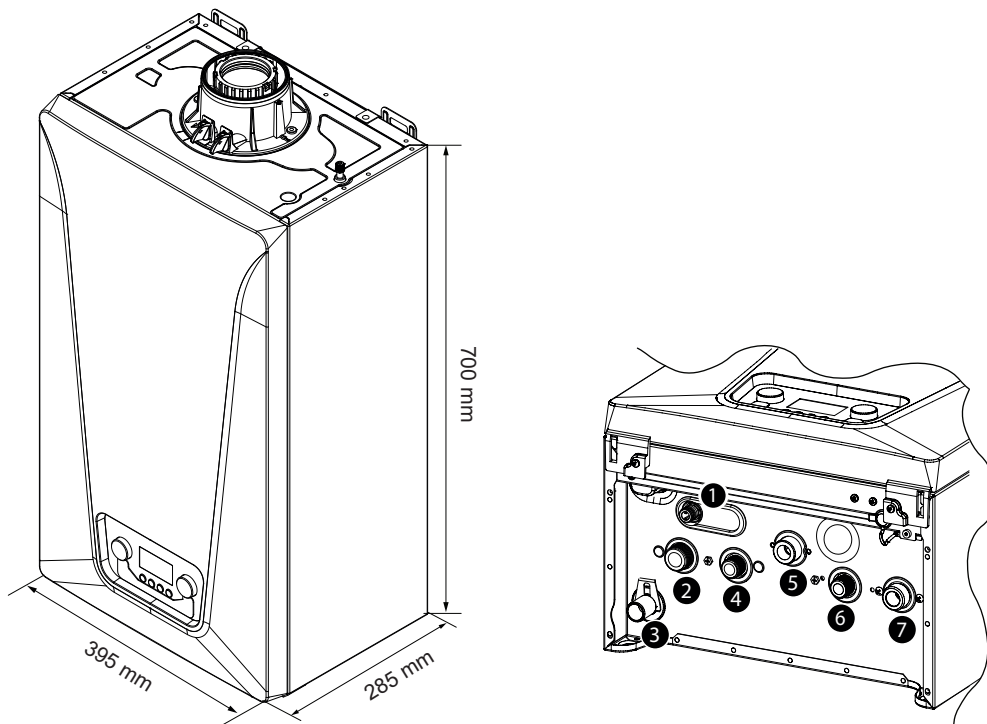

BO-0000199-1

- 1 Safety valve
- 2 Heating circuit flow fitting (G3/4")
- 3 Fitting for condensate discharge
- 4 DHW (Domestic Hot Water) outlet fitting (G1/2")
- 5 Gas inlet fitting (G3/4")
- 6 Domestic cold water inlet fitting (G1/2")
- 7 Heating circuit return fitting (G3/4")

4 Description of the product

4.1 General description

The purpose of this gas-fuelled condensing boiler is to heat water to a temperature that is lower than boiling point at atmospheric pressure. It must be connected to a heating installation and to a domestic hot water distribution system that is compatible with its power and performance ratings. Features of this boiler:

- Low pollutant emissions,
- High-efficiency heating,
- Front control panel with display,
- Lightweight and compact.

4.2 Operating principle

4.2.1 Air-gas adjustment

The air is drawn in by the fan and gas injected directly at the height of the venturi. The fan revolution speed is regulated automatically by the electronic board based on the adjustment settings. The gas and air are mixed in the manifold. The gas/air ratio ensures that the quantity of gas and air are adjusted correctly to always obtain optimal combustion. The gas/air mixture is fed into the burner at the front of the exchanger.

Here, the electric igniter triggers the mixture with a series of sparks that burn, producing thermal energy.

4.2.2 Combustion

The burner heats the heating water circulating in the heat exchanger. When the temperature of the combustion gas is lower than the dew point (around 55 °C), the water vapour contained in the combustion gas condenses in the flue gas side of the heat exchanger. The heat recovered during this condensation process (the latent heat or condensing heat) is also transferred to the heating water. Once cooled, the combustion gases are discharged through the exhaust pipe. The condensed water is discharged through a siphon.

4.2.3 Heating and domestic hot water production

In boilers used for heating and for producing domestic hot water, an integrated plate heat exchanger heats the domestic water. The heated water is then channelled to the heating installation or to the plate heat exchanger via a three-way valve. A flow sensor detects that a hot water tap has been turned on and communicates this to the PCB, which switches the three-way valve to the hot water position and activates the pump. The three-way valve is spring-loaded and only consumes electricity when switching from one position to another. Precedence is given to a heat request in domestic water mode.

4.3 Control panel description

Fig.3 Control panel

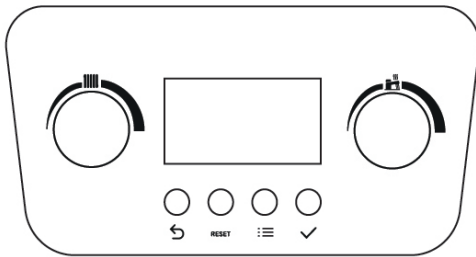
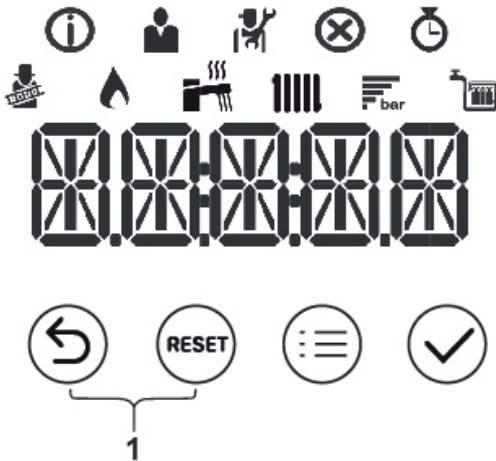



Fig.4 Display screen













4.3.1 Description of the control panel





Knobs

-  **HEATING:** Using this knob you can modify the flow temperature for the heating installation (heating setpoint 25-80 °C).
 - turn the knob anti-clockwise to reduce the temperature or to the left to scroll through the menus. With an outside sensor connected it is possible to limit the setpoint value;
 - turn the knob clockwise to increase the temperature or to the right to scroll through the menus.
-  **DOMESTIC HOT WATER:** Using this knob you can modify the domestic hot water temperature (DHW setpoint 35-60 °C) or scroll through the menus to the left and right:
 - turn anti-clockwise to reduce the temperature.
 - turn clockwise to increase the temperature.

Icons

-  Chimney sweep mode is enabled (forced full load or low load for CO₂ measurement).
-  The burner is on.
-  Display of the system water pressure.
-  DHW operation is enabled.
-  CH operation is enabled.
-  Information menu: read out various current values.
-  User menu: user-level parameters can be configured.
-  Installer menu: installer-level parameter can be configured.
-  Error menu: errors can be read out.
-  Counter menu: various counters can be read out.

Buttons

-  Back (previous menu)
-  Manual reset
-  Menu
-  Confirms selection or value.

- 1 Chimney sweep mode:
Press the **Back** and **Manual reset** keys simultaneously.

4.4 Accessories & options

Consult the sales catalogue for all available accessories and options.

5 Operation

5.1 Start-up

5.1.1 Procedure for first start-up

The following information appears on the display when the boiler is electrically powered:

1. The message "INIT" appears, indicating that the "Initialisation" phase is active (a few seconds);
2. The software version "Vxx.xx." appears (two seconds);
3. The software version for boiler settings "Pxx.xx." appears (two seconds);
4. The boiler and heating installation venting phase has started. During operation, the display shows in alternate mode "-----", the word "DEAIR" and the pressure value for the heating circuit. This phase lasts 6 minutes and 20 seconds, at the end the boiler is ready for operation;
5. The  symbol and the "x.x" installation water pressure value appear.

In the event of a power outage the procedure will be repeated from the beginning.

To activate a heating request, the room thermostat must be set to a temperature above the current temperature (or open a domestic water tap.)

5.1.2 Changing the heating flow temperature

1. Use the knob  to adjust the flow temperature in heating mode.
 - Turn the knob anti-clockwise to reduce the temperature value.
 - Turn the knob clockwise to increase the temperature value.



Important

With an outside sensor connected it is possible to lower the setpoint value.

2. Press the **F4** key to confirm the value or wait a few seconds until the value is automatically saved.



Important

The flow temperature on the display automatically matches the temperature set when using a:

- Weather-dependent regulator.
- **OpenTherm** regulator.

5.1.3 Changing the domestic hot water (DHW) temperature

1. Use the knob  to adjust the domestic hot water temperature.
 - Turn the knob anti-clockwise to reduce the temperature value.
 - Turn the knob clockwise to increase the temperature value.
2. Press the **F4** key to confirm the value or wait a few seconds until the value is automatically saved.

Fig.5 Scrolling through the menus and/or settings

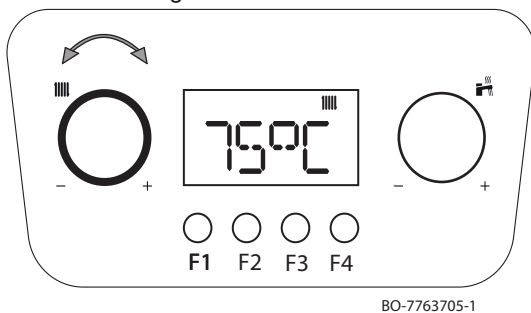
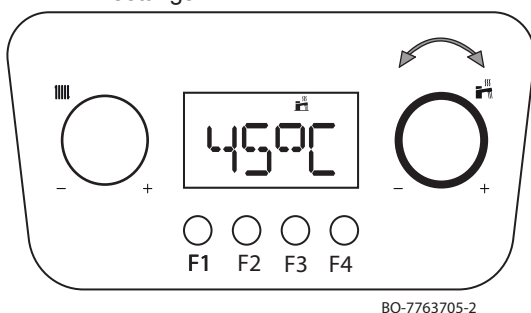



Fig.6 Scrolling through the menus and/or settings



5.2 Shutdown

5.2.1 Switching off the heating and domestic hot water (DHW)

Heating mode can also be disabled by turning the  knob anti-clockwise until the word **OFF** appears on the display.

**Important**

When heating mode is re-enabled check, by turning the knob, that the comfort temperature is that requested.

**Important**

Heating is disabled but the frost protection function remains activated.

Domestic hot water mode can also be disabled by turning the  knob anti-clockwise until the word **OFF** appears on the display.

To switch the boiler off completely, switch off the power supply to the appliance and close the gas cock.

**Important**

In this condition, the boiler and the heating installation are not protected against frost.

5.3 Frost protection

It is a good idea to prevent the heating installation from draining completely, as changing the water can result in unnecessary and damaging limescale deposits from forming inside the boiler and heating elements. If the thermal installation is not intended to be used during the winter months and there is a risk of frost, we recommend mixing suitable antifreeze solutions designed for a specific purpose (e.g. propylene glycol, which contains limescale and corrosion inhibitors) into the water in the installation. The boiler's electronic control system is equipped with an "antifreeze" function for the heating system. This function activates the boiler pump when the heating system flow temperature falls below 7 °C. If the water temperature reaches 4 °C, the burner is switched on, bringing the system water to a temperature of 10 °C. When this value is reached the burner switches off and the pump continues to operate for another 3 minutes.

**Important**

The frost protection function will not work if there is no power being supplied to the boiler or if the gas supply cock is closed.

6 Settings

6.1 Access to USER parameters

Fig.7 Accessing the user parameters

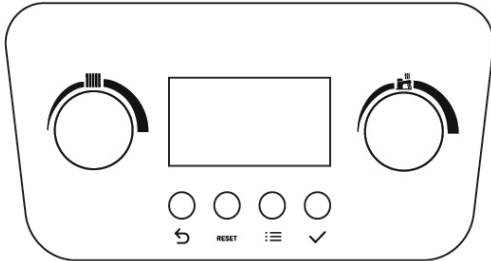

To display/modify the list of USER parameters, proceed as follows:

- press the + keys simultaneously, the symbol on the menu bar starts to flash;
- turn the knob until the appears. Press the key to confirm;
- turn the knob until you reach the required setting. Press the key to confirm;
- modify the value of the parameter using knob;
- Press the key to confirm;
- Press the key to exit.



Important

The factory settings for certain settings may differ based on the market the product is destined for.

6.2 List of USER parameters

Tab.9 Table of parameters

Name	Description	Factory value	Minimum	Maximum	Level
AP016	CH operation 0: Off 1: On	1	–	–	User
AP017	Domestic hot water (DHW) 0: Off 1: On	1	–	–	User
AP073	Average external temperature [°C] when switching from summer/ winter mode (with outside sensor)	22	10	30	User
AP074	Force summer mode (with outside sensor) 0: Auto according to AP073 1: Summer	0	–	–	User
DP004	Anti-legionella function 0: Disabled 1: Weekly 2: Daily (only available with Room Unit)	0	–	–	User
DP070	Domestic hot water temperature setpoint. In the case of operation with a calorifier tank and programming via room unit corresponding to the comfort setpoint [°C]	60	35	60	User
DP200	DHW mode: 0: Domestic hot water programming (only available with Room Unit) 1: Manual (boiler with calorifier tank) – Preheating active (instantaneous boiler) 2: Antifreeze (boiler with calorifier tank) – No preheating (instantaneous boiler)	2	–	–	User

Tab.10 Settings table with eMO Life

Name	Description	Factory value	Minimum	Maximum	Level
CP060	Required ambient temperature (°C) in the zone in the holiday/anti-freeze period	6	5	20	User
CP070	Maximum ambient setpoint temperature (°C) in reduced mode that enables switching to comfort mode with climate control (with outside sensor)	16	5	30	User
CP080	Temperature (°C) set by SLEEP activity in the zone	16	5	30	User
CP081	Temperature (°C) set by HOME activity in the zone	20	5	30	User
CP082	Temperature (°C) set by AWAY activity in the zone	6	5	30	User
CP083	Temperature (°C) set by MORNING activity in the zone	21	5	30	User
CP084	Temperature (°C) set by EVENING activity in the zone	22	5	30	User
CP085	Temperature (°C) set by CUSTOM activity in the zone	20	5	30	User
CP200	Required ambient temperature (°C) for the zone in manual mode	20	5	30	User
CP250	Correct the temperature measured by the room unit	0	-5	+5	User
CP320	Zone operating mode 0: Scheduling 1: Manual 2: Off	0	–	–	User
CP510	Temporary room setpoint per zone	20	5	30	User
CP550	Fireplace mode 0: Disabled 1: Enabled	0	–	–	User
CP570	Timer programme selected by User 0: Program 1 1: Program 2 2: Program 3	0	–	–	User
DP060	Timer programme selected for DHW 0: Program 1 1: Program 2 2: Program 3	0	–	–	User
DP080	Reduced temperature setpoint for the domestic hot water tank [°C]	35	10	60	User
DP337	Domestic hot water temperature setpoint for the holiday period [°C]	10	10	60	User

**Important**

The factory values of some parameters may differ according to the target market of the product.

7 Maintenance

7.1 General

The boiler does not require any special maintenance. However, the boiler must be serviced annually in accordance with the Installation and Service Manual and the relevant section of the Benchmark Service Record completed in order to maintain the warranty.



Note

Taking out a maintenance contract is recommended.



Caution

Maintenance operations must be performed by a qualified competent person.

Use only BAXI genuine spare parts.

The painted panels should be wiped with a damp cloth and then dried completely. **DO NOT USE ABRASIVE CLEANING AGENTS.**

7.2 Maintenance instructions

To ensure continued safety, functionality and efficiency, the boiler must be inspected annually by the installer/service engineer in order to ensure the performance of the product constant over time, we recommend having the boiler's energy efficiency checked annually by a qualified technician. Accurate maintenance is always a reason for safety and savings in the management of the system.

Periodically check that the pressure shown on the display with the system cold is between 1 - 1.5 bar. If it is lower, act on the system filling tap. It is advisable that the opening of this tap is carried out very slowly in order to facilitate degassing.



Important

The boiler is equipped with a hydraulic pressure switch which does not allow the boiler to operate in case of low pressure.

If frequent pressure drops should occur, call the installer/service engineer

7.2.1 Filling the installation

If the water pressure is too low, the system must be re-pressurised.

The normal operating water pressure is between 1 and 2 bar. If the pressure exceeds 3 bar the safety pressure valve will operate and a fault is indicated. Ensure that the temporary filling loop is disconnected. Contact your installer.

It may be necessary to repressurise the system occasionally (when the water pressure falls below 0.7). A filling device (the filling loop) will be fitted on the system. This will be on the boiler itself, or on pipework near to the boiler. Seek advice from your installer.



Note

If the water pressure requires regular re-pressurising a fault or leak is indicated. Seek advice from your installer.

Fig.8 Water pressure

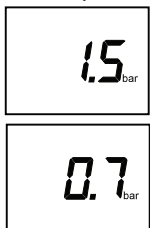
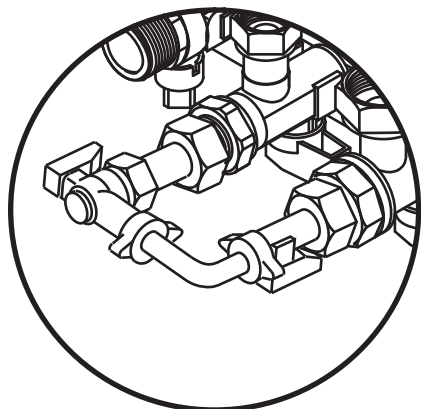

Fig.45 Filling loop



PN-0000260

1. Fully open one of the taps first, and then while watching the pressure gauge, carefully open the second tap.

i Note
The system pressure is shown at all times on the display when there is power to the boiler.

2. When the figures on the display indicate between 1 and 1.5 bar turn both taps off.
3. Disconnect the filling pipe from the taps (a small amount of water may be present) and remove it. Keep the pipe in a safe place for future use.
4. If blanking caps are available fit them to the taps.

i Note
Go to the "How to videos" section of the "Advice" page at www.baxi.co.uk for further details.

5. When the correct pressure is restored the boiler will reset automatically.

Fig.10 Venting the installation

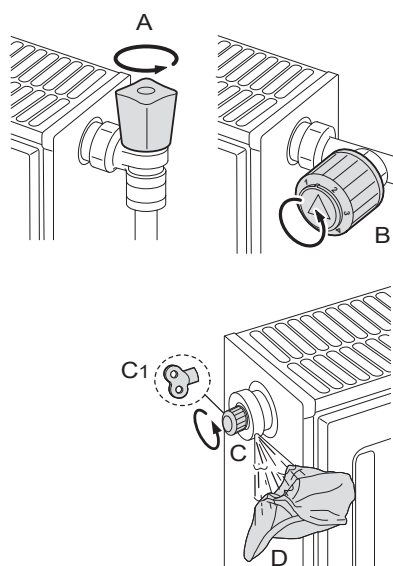

BO-0000026

7.2.2 Venting the installation

It is essential to eliminate any air in the boiler, pipes or fittings because this can cause irritating noise during heating or the intake of water. To do this, proceed as follows:

1. Open the valves (A & B) of all the radiators connected to the central heating system.
2. Set the ambient thermostat as high as possible.
3. Wait for the radiators to heat up.
4. Set the ambient thermostat as low as possible.
5. Wait about 10 minutes until the radiators have cooled down.
6. Vent the radiators. Start with the lower floors.
7. Open the vent valve (C & C1) holding a cloth (D) against the valve.
8. Wait until water comes out of the vent valve and then tighten it again.
9. After venting, check that the system is still at sufficient pressure.

i Important
Take care as the water might still be hot.

i Important
If the hydraulic pressure of the water in the central heating system is below 0.8 bar, it is advised to increase the pressure (the recommended hydraulic pressure is 1.0 - 1.5 bar).

7.3 Maintenance message

Fig.11 Maintenance message

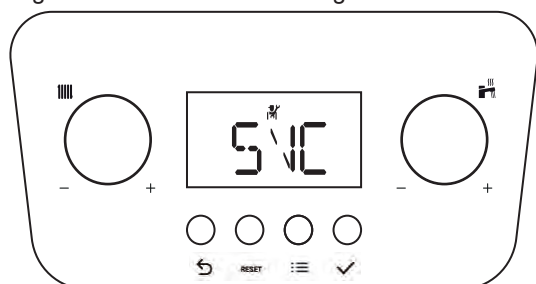

The purpose of this function is to warn the user that the boiler requires maintenance.

When the letters **SVC** appear on the screen and the symbol  flashes, the boiler requires maintenance. Contact your installer.

8 Troubleshooting

8.1 Temporary and permanent faults

The codes on the display indicate two types of fault: volatile and permanent. The first item shown on the display is a letter followed by a two-digit number. The letter indicates the type of fault: temporary (**H**) or permanent (**E**). The number indicates the group in which the fault that has occurred is classified according to its impact on safe and reliable operation. The second item shown flashes alternately with the first and consists of a two-digit number that indicates the type of fault which has occurred (see the following fault tables).

TEMPORARY FAULT (A/H.x.x.)

A temporary fault is shown on the display by the letter "A" or "H" followed by a number (group). A temporary fault is a type of fault that does not cause a permanent stoppage of the boiler. It has the following characteristics:

A: The appliance continues to operate. It disappears as soon as the cause has been resolved.

H: Disappears when the error condition is removed, in some cases even after 10 minutes.

PERMANENT FAULT (E.x.x)

A permanent fault is shown on the display by the letter "E" followed by a number (group). Press the RESET button for one second. If faults are shown frequently, contact our authorised technical assistance centre.

E: Stoppage, reset required..

8.2 Error codes

Tab.11 List of temporary faults

DISPLAY		DESCRIPTION OF TEMPORARY FAULTS	CAUSE – Check/Solution <i>An installer is required for most checks and solutions.</i>
Group code	Specific code		
H.00	.42	Pressure sensor open/faulty	SENSOR/CONNECTION PROBLEM Check the operation of the pressure sensor Check the sensor/PCB connection
H.01	.00	Temporary communication failure in the PCB	The error is resolved automatically
H.01	.05	Maximum temperature difference value between flow and return reached.	INSUFFICIENT CIRCULATION Check the boiler/installation circulation Activate a manual venting cycle Check the installation pressure OTHER CAUSES Check the cleanliness of the exchanger Check the operation of the temperature sensors Check the temperature sensor connection
H.01	.08	Flow temperature increase in heating mode too quick.	INSUFFICIENT CIRCULATION Check the boiler/installation circulation Activate a manual venting cycle Check the installation pressure Check the operation of the pump OTHER CAUSES Check the cleanliness of the exchanger Check the operation of the temperature sensors Check the temperature sensor connection
H.01	.14	Maximum flow or return temperature value reached.	INSUFFICIENT CIRCULATION Check the boiler/installation circulation Activate a manual venting cycle

DISPLAY		DESCRIPTION OF TEMPORARY FAULTS	CAUSE – Check/Solution <i>An installer is required for most checks and solutions.</i>
Group code	Specific code		
H.01	.18	No water circulation (temporary).	INSUFFICIENT CIRCULATION Check the installation pressure Activate a manual venting cycle Check the operation of the pump Check the boiler/installation circulation TEMPERATURE SENSOR ERROR Check the operation of the temperature sensors Check the temperature sensor connection
H.01	.21	Flow temperature increase during domestic hot water operation too fast.	INSUFFICIENT CIRCULATION Check the installation pressure Activate a manual venting cycle Check the operation of the pump Check the boiler/installation circulation TEMPERATURE SENSOR ERROR Check the operation of the temperature sensors Check the connection of the temperature sensors
H.02	.00	Reset in progress.	It resolves itself
H.02	.02	Waiting for configuration settings to be entered (CN1,CN2).	CN1/CN2 CONFIGURATION MISSING Configure CN1/CN2
H.02	.03	Configuration settings (CN1,CN2) not entered correctly.	Check configuration CN1/CN2 Configure CN1/CN2 correctly
H.02	.04	PCB settings cannot be read.	MAIN PCB ERROR Configure CN1/CN2 Replace the main PCB
H.02	.05	Setting memory not compatible with the boiler PCB type.	Contact the Service Network
H.02	.07	Low pressure in heating circuit (water filling required).	Check the installation pressure and restore Check the expansion vessel pressure Check for boiler/installation leaks
H.02	.09	Partial stoppage of the boiler (antifreeze function active)	SIGNAL INDICATING BLOCKING INPUT Contact X15 open, check connected devices Parameter configuration error: Check AP001
H.02	.10	Total stoppage of the boiler (antifreeze function not active)	SIGNAL INDICATING BLOCKING INPUT Contact X15 open, check connected devices Parameter configuration error: Check AP001
H.02	.70	External unit heat recovery test failed	PCB accessory error SCB-09 Check the device connected to contact X9
H.03	.00	No identification data for boiler safety device.	MAIN PCB ERROR Contact the Service Network
H.03	.02	Temporary flame loss	ELECTRODE PROBLEM Check the electrode connection and wiring Check the condition of the electrode GAS SUPPLY Check the gas supply pressure Check the gas valve calibration FLUE GAS PIPES Check the pipes and the terminal
H.03	.05	Power supply voltage too low	Check the mains voltage
H.03	.54	Temporary flame loss Shutdown due to the power supply voltage being too low	ELECTRODE PROBLEM Check the electrode electrical connections Check the condition of the electrode GAS SUPPLY Check the gas inlet pressure Check the gas valve calibration FLUE GAS EXHAUST PIPE Check the air intake and flue gas exhaust terminal Check the power supply voltage

Tab.12 List of permanent faults (boiler stoppage, reset required)

DISPLAY		DESCRIPTION OF PERMANENT FAULTS (RESET)	CAUSE – Check/Solution <i>An installer is required for most checks and solutions.</i>
Group code	Specific code		
E.00	.04	Return temperature sensor disconnected	SENSOR/CONNECTION PROBLEM Check the operation of the temperature sensor Check the sensor/PCB connection
E.00	.05	Return temperature sensor short circuited	SENSOR/CONNECTION PROBLEM Check the operation of the sensor Check the sensor/PCB connection
E.00	.16	DHW tank temperature sensor not connected	SENSOR OPEN Check the operation of the sensor Check the sensor/PCB connection When removing a domestic hot water tank, set parameter DP150=1
E.00	.17	DHW tank temperature sensor short-circuited	SENSOR CLOSED Check the operation of the sensor Check the sensor/PCB connection
E.00	.20	The flue gas temperature sensor is not connected or measured a temperature below the range	SENSOR OPEN Check the operation of the sensor Check the sensor/PCB connection
E.00	.21	The flue gas temperature sensor has short-circuited or measured a temperature above the range	SENSOR CLOSED Check the operation of the sensor Check the sensor/PCB connection
E.01	.04	Flame loss detected five times in 24 hours	GAS SUPPLY Check the gas supply pressure Check the gas valve calibration ELECTRODE PROBLEM Check the electrode connection and wiring Check the condition of the electrode FLUE GAS PIPES Check the air intake and flue gas exhaust pipes EXCHANGER ON FLUE GAS SIDE BLOCKED Check the cleanliness of the exchanger MAINS VOLTAGE Check the power supply voltage
E.01	.12	Temperature measured by return sensor greater than flow temperature	SENSOR/CONNECTION PROBLEM Check that the sensors are positioned the correct way around Check that the flow sensor is in the correct position Check the return temperature in the boiler Check the operation of the sensors
E.01	.17	No water circulation (permanent)	INSUFFICIENT CIRCULATION Check the installation pressure Activate a manual venting cycle Check the operation of the pump Check the boiler/installation circulation SENSOR ERROR Check the operation of the temperature sensors Check the temperature sensor connection
E.01	.20	Maximum flue gas temperature reached	EXCHANGER ON FLUE GAS SIDE BLOCKED Check the cleanliness of the exchanger
E.02	.13	Total stoppage of the boiler (antifreeze function not active)	SIGNAL INDICATING BLOCKING INPUT Contact X15 open, check connected devices Parameter configuration error: Check setting AP001
E.02	.17	Permanent communication failure in the PCB	MAIN PCB ERROR Check for any electromagnetic interference Contact the Service Network

DISPLAY		DESCRIPTION OF PERMANENT FAULTS (RESET)	CAUSE – Check/Solution <i>An installer is required for most checks and solutions.</i>
Group code	Specific code		
E.02	.35	Critical safety device disconnected	COMMUNICATION FAULT Start the auto-detect function (parameter AD) Check the devices connected to contact X9
E.02	.39	Minimum pressure not reached after 6 minutes of automatic filling	AUTOMATIC FILLING ERROR Check automatic filling is working
E.02	.47	Connection to external device unsuccessful	ELECTRICAL CONNECTION ERROR Start the auto-detect function (parameter AD)) Check the electrical connections of external devices.
E.04	.01	Flow temperature sensor short circuited	SENSOR/CONNECTION PROBLEM Check the sensor/PCB connection Check the operation of the sensor
E.04	.02	Flow temperature sensor disconnected	SENSOR/CONNECTION PROBLEM Check the sensor/PCB connection Check the operation of the sensor
E.04	.03	Maximum flow temperature exceeded or flow temperature sensor short circuited	INSUFFICIENT CIRCULATION Check the boiler/installation circulation Activate a manual venting cycle Check the operation of the sensors
E.04	.08	Maximum safe temperature value reached	INSUFFICIENT CIRCULATION Check the pressure in the installation Switch on the manual degassing function Check that the pump is working Check the circulation in the boiler/installation OTHER POSSIBLE CAUSES Check the safety thermostat connection Check that the safety thermostat is working correctly
E.04	.10	Burner failed to ignite after 4 attempts	GAS SUPPLY Check the gas supply pressure Check the gas valve electrical connection Check the gas valve calibration Check the operation of the gas valve ELECTRODE PROBLEM Check the electrode electrical connections Check the electrode condition OTHER CAUSES Check the operation of the fan Check the condition of the flue gas exhaust (blockages)
E.04	.12	Ignition failure for monitoring parasitic flame	Check the ground circuit Check the power supply voltage Check the electrode conditions
E.04	.13	Fan blade blocked or maximum rpm exceeded	FAN/PCB PROBLEM Check the PCB-fan connection Check the fan operation
E.04	.17	Fault in gas valve control circuit	MAIN PCB ERROR Check the electrical connections for the gas valve
E.04	.18	The flow temperature is below the minimum temperature or the flow temperature sensor is not connected	SENSOR/CONNECTION PROBLEM Check the sensor/PCB connection Check the operation of the sensor
E.04	.23	Communication internal stoppage	Switch the power supply off and on again and then RESET
E.04	.29	Communication internal stoppage	Switch the power supply off and on again and then RESET
E.04	.254	Fault in gas valve control circuit	MAIN PCB ERROR Check the electrical connections

Tab.13 List of warnings

DISPLAY		DESCRIPTION OF WARNINGS BEFORE A FAULT IS DETECTED	CAUSE – Check/Solution
Group code	Specific code		
A.00	.28	Solar temperature sensor is either removed or measures a temperature below range	Check the solar temperature sensor wiring. Replace the sensor if necessary. In case of removal of the solar tank, set the parameter DP150=1.
A.00	.29	Solar temperature sensor is either shorted or measures a temperature above range	Check the solar temperature sensor wiring. Replace the sensor if necessary.
A.00	.34	Outdoor temperature sensor expected but not detected	OUTDOOR SENSOR NOT DETECTED Enter the correct value of the parameter AP091 Connect the outdoor sensor Outdoor sensor is not connected correctly
A.02	.06	Low pressure in heating circuit	Check the installation pressure and restore Check the expansion vessel pressure Check for boiler/installation leaks
A.02	.36	Functional device disconnected	COMMUNICATION FAULT Start the auto-detect function (parameter AD) Check the devices connected to contact X9
A.02	.37	Passive functional device disconnected	COMMUNICATION FAULT Start the auto-detect function (parameter AD) Check the devices connected to contact X9
A.02	.45	Connection error	COMMUNICATION FAULT Start the auto-detect function (parameter AD))
A.02	.46	Device priority error	COMMUNICATION FAULT Start the auto-detect function (parameter AD))
A.02	.48	Unit function configuration error	ELECTRICAL CONNECTION ERROR Start the auto-detect function (parameter AD)) Check electrical connections of external devices
A.02	.49	Failed node initialisation	ELECTRICAL CONNECTION ERROR Start the auto-detect function (parameter AD)) Check electrical connections of external devices
A.02	.54	Open Therm bus power supply error	Check the devices connected to contact X17 - Terminal board M2 (7-8)
A.02	.55	Incorrect or missing serial number	Contact the Service Network
A.02	.76	Internal memory reserved for full customisation of settings. No further changes can be made	Contact the Service Network

**Important**

When connecting a Room Unit/Control Unit to the boiler, the code “254” is always shown in the event of a fault.. Read the fault code shown on the boiler display.

8.3 Fault finding

Tab.14 Problems and solutions

Problem	Possible causes	Solution
There is no domestic hot water.	The boiler is not working.	Check that the boiler is being supplied with power. Check fuses and the switches. Check whether the gas isolation cock is properly open. If the property has a prepayment meter ensure it has sufficient credit.
	The DHW function is switched off.	Activate the DHW mode.
	The water pressure is too low (< 0.5 bar).	Re-pressurise the system.
	Insufficient flow.	Flow must be at least 2 litres per minute.
The radiators are cold.	The temperature set point for the heating is too low.	Increase the value with the CH temperature knob or if a room thermostat is connected, increase the temperature on the room thermostat.
	The heating mode is deactivated.	Activate the heating mode.
	The radiator valves are not open.	Open the valves of all radiators connected to the system.
	The boiler is not working.	Check that the boiler is being supplied with power. Check fuses and switches. Check whether the gas isolation cock is properly open. If the property has a prepayment meter ensure it has sufficient credit.
The boiler is not working.	The water pressure is too low (< 0.5 bar).	Re-pressurise the system.
	The temperature set point for the heating is too low.	Increase the value with the CH temperature knob or if a room thermostat is connected, increase the temperature on the room thermostat.
	No demand for heating.	Ensure that timers & thermostats are calling for heat.
	No power supply.	Check that the boiler is being supplied with power. Check the fuses and switches.
	The water pressure is too low (< 0.5 bar).	Re-pressurise the system.
	The boiler is indicating an error.	Press the Reset button. Correct the error, if possible.
	The gas pressure is too low.	Check whether the gas isolation cock is fully open. Open the gas isolation cock.
Condensate drain blocked.	Check drain, especially any external runs in freezing temperatures.	

If the boiler is not working also check section "Operation checking procedure and basic fault identification" or contact your Installer.

9 Decommissioning

9.1 Decommissioning procedure

**Caution**

Only qualified persons are authorised to work on the appliance and system to decommission.

If your boiler needs to be decommissioned either temporarily or permanently the following should be performed:

1. Switch off the boiler's electrical connection.
2. Close the gas isolation tap.
3. Drain the central heating system.

Seek the advice of your installer.

10 Disposal

10.1 Disposal and recycling

The appliance is composed of multiple components made from various different materials, such as steel, copper, plastic, fibreglass, aluminium, rubber, etc..

These materials may be highly pollutant. This means that the boiler must be disposed of correctly by contacting staff at the nominated disposal facility or by taking it to a centre that is authorised to dispose of bulky waste (domestic appliances).

Fig.12 Recycling



Warning

Removal and disposal of the boiler must be carried out by a qualified installer in accordance with local and national regulations.

11 Environmental

11.1 Energy saving

Tips on saving energy:

- Do not cover radiators. Do not hang curtains in front of radiators.
- Install reflective panels behind the radiators to prevent heat loss.
- Insulate the pipes in rooms that are not heated (cellars and lofts).
- Install loft insulation & double glazing.
- Use draught excluders where necessary.
- Upgrade any older boiler external controls.
- Turn down room thermostats by 1°.
- Turn off radiators in rooms not in use.
- Do not run hot (or cold) water pointlessly.
- Fit a water-saving shower head to save up to 40 % energy.
- Take showers rather than baths. A bath consumes twice as much water and energy.

11.2 Room thermostats and settings

Various models of room thermostat are available. The thermostat type and setting affect the total energy consumption.

A few tips:

- A modulating thermostat in combination with thermostatic radiator valves saves energy and offers considerable comfort. This combination gives you flexibility with the temperatures. Do not fit thermostatic radiator valves in the room in which the room thermostat is installed.
- Completely closing and opening thermostatic valve radiators causes undesirable temperature fluctuations. Open and close thermostatic valves in small steps.
- Lower the thermostat to around 20°C. This reduces heating costs and energy consumption.
- Lower the room thermostat temperature temporarily if opening windows to air the rooms.
- If you are using an ON/OFF type thermostat, reduce the water temperature value in summer (e.g. 60°C in summer and 80°C in winter).
- When setting an hourly programmable thermostat, consider days when you are absent or on holiday. Electricity production and energy savings reach their optimum level with a programmed and activated timer programme.

12 Warranty

12.1 General

To make sure your boiler warranty is activated and maintained, it is essential that the:

1. Benchmark checklist is completed by your installer
2. Warranty is registered within 30 days
3. Boiler has an annual service



Important

Please note that failure to adhere to terms and conditions will invalidate your warranty.

12.2 Standard warranty terms and conditions

Warranty registration, service & repair

For full terms and conditions, visit www.baxi.co.uk/terms.

Benchmark checklist

The Benchmark Checklist will be completed by your installer and records that the boiler has been installed and commissioned correctly. It can be found at the back of the installation and service manual and should be kept in a safe place for the life of the boiler. We will check that the Benchmark Checklist has been completed on an in-warranty visit.

Ways to register your warranty

If your boiler is eligible for an extended warranty, your installer may register the product on your behalf and provide you with the relevant documentation. Please check with your installer.

Should this not be the case, you can register your warranty online at www.baxi.co.uk/registration

Annual service

A service must be completed every 12 months from the date of installation to maintain your warranty.

This service must be completed by one of the following:

- A Gas Safe registered installer/engineer
- Baxi Customer Support; call us 0344 871 1545

Please make sure that your engineer has logged the service information at the back of the installation and service manual. You will be asked for your service history on any in-warranty repair visit.

If you experience a problem with your boiler

For any in or out of warranty repair, Baxi Customer Support is on hand to help you. Call our award-winning team to arrange for one of our nationwide team of Gas Safe registered engineers to visit.

If your product is in warranty, everything is free of charge, subject to our warranty terms and conditions. If it is out of warranty, we can still help and offer a range of options you can choose from to suit your needs.

Contact Baxi Customer Support 0344 871 1545

Opening hours

Monday - Friday, 8.00am - 6.00pm

Weekends and Bank Holidays, 8.30am - 2.00pm

Please note calls may be recorded for training and monitoring purposes.

When contacting Baxi Customer Support, please have the following information to hand:

- Boiler serial number.









- Proof of purchase if you do not have the boiler serial number

Please note that for in-warranty repairs, our engineers will ask to see your service history record, completed Benchmark Checklist and details of your installer. These can all be found in the Installation and Service manual.

13 Appendix

13.1 Product fiche - Combination boilers

Tab.15 Product fiche for combination boilers

		424	430	424 LPG	430 LPG
Space heating - Temperature application		Medium	Medium	Medium	Medium
Water heating - Declared load profile		XL	XL	XL	XL
Seasonal space heating energy efficiency class					
Water heating energy efficiency class					
Rated heat output (<i>Prated or Psup</i>)	kW	20	20	20	20
Space heating - Annual energy consumption	GJ	62	62	62	62
Water heating - Annual energy consumption	kWh ⁽¹⁾	39	42	39	42
	GJ ⁽²⁾	17	17	17	17
Seasonal space heating energy efficiency	%	93	93	93	93
Water heating energy efficiency	%	88	89	88	89
Sound power level L _{WA} indoors	dB	50	49	50	49
(1) Electricity (2) Fuel					



See

For specific precautions about assembling, installing and maintaining: Safety, page 5

13.2 Package fiche - boilers

Fig.13 Package fiche for boilers indicating the space heating energy efficiency of the package

Seasonal space heating energy efficiency of boiler ①
'I' %

Temperature control
 from fiche of temperature control

Class I = 1%, Class II = 2%, Class III = 1.5%,
 Class IV = 2%, Class V = 3%, Class VI = 4%,
 Class VII = 3.5%, Class VIII = 5%

②
 + %

Supplementary boiler
 from fiche of boiler

Seasonal space heating energy efficiency (in %)

③
 (- 'I') x 0.1 = ± %

Solar contribution
 from fiche of solar device

Collector size (in m²)

Tank volume (in m³)

Collector efficiency (in %)

Tank rating ⁽¹⁾
 A* = 0.95, A = 0.91,
 B = 0.86, C = 0.83,
 D - G = 0.81

('III' x + 'IV' x) x 0.9 x (/100) x = + %

④

(1) If tank rating is above A, use 0.95

Supplementary heat pump
 from fiche of heat pump

Seasonal space heating energy efficiency (in %)

⑤
 (- 'I') x 'II' = + %

Solar contribution AND Supplementary heat pump
 select smaller value

0.5 x ^④ OR 0.5 x ^⑤ = - ^⑥ %

Seasonal space heating energy efficiency of package ⑦
 %

Seasonal space heating energy efficiency class of package

☐	☐	☐	☐	☐	☐	☐	☐	☐	☐
G	F	E	D	C	B	A	A⁺	A⁺⁺	A⁺⁺⁺
<30%	≥30%	≥34%	≥36%	≥75%	≥82%	≥90%	≥98%	≥125%	≥150%

Boiler and supplementary heat pump installed with low temperature heat emitters at 35°C ?
 from fiche of heat pump

⑦
 + (50 x 'II') = %

The energy efficiency of the package of products provided for in this fiche may not correspond to its actual energy efficiency once installed in a building, as this efficiency is influenced by further factors such as heat loss in the distribution system and the dimensioning of the products in relation to building size and characteristics.

- I The value of the seasonal space heating energy efficiency of the preferential space heater, expressed in %.
- II The factor for weighting the heat output of preferential and supplementary heaters of a package as set out in the following table.
- III The value of the mathematical expression: $294/(11 \cdot \text{Prated})$, whereby 'Prated' is related to the preferential space heater.
- IV The value of the mathematical expression $115/(11 \cdot \text{Prated})$, whereby 'Prated' is related to the preferential space heater.

Tab.16 Weighting of boilers

$P_{sup} / (P_{rated} + P_{sup})^{(1)(2)}$	II, package without hot water storage tank	II, package with hot water storage tank
0	0	0
0.1	0.3	0.37
0.2	0.55	0.70
0.3	0.75	0.85
0.4	0.85	0.94
0.5	0.95	0.98
0.6	0.98	1.00
≥ 0.7	1.00	1.00

(1) The intermediate values are calculated by linear interpolation between the two adjacent values.
(2) Prated is related to the preferential space heater or combination heater.

Tab.17 Package efficiency

Baxi Combi		424	430	424 LPG	430 LPG
Temperature control X	%				
Temperature control Y	%				

13.3 Package fiche - Combination heaters (boilers or heat pumps)

Fig.14 Package fiche for combination heaters (boilers or heat pumps) indicating the water heating energy efficiency of the package

Water heating energy efficiency of combination heater ①
 %

Declared load profile:

Solar contribution ②
 from fiche of solar device Auxiliary electricity

$(1.1 \times \text{'I'} - 10\%) \times \text{'II'} - \text{'I'} = +$ %

Water heating energy efficiency of package under average climate ③
 %

Water heating energy efficiency class of package under average climate

	<input type="checkbox"/>	<input type="checkbox"/>	<input type="checkbox"/>	<input type="checkbox"/>	<input type="checkbox"/>	<input type="checkbox"/>	<input type="checkbox"/>	<input type="checkbox"/>	<input type="checkbox"/>	<input type="checkbox"/>
	G	F	E	D	C	B	A	A⁺	A⁺⁺	A⁺⁺⁺
<input type="checkbox"/> M	<27%	≥27%	≥30%	≥33%	≥36%	≥39%	≥65%	≥100%	≥130%	≥163%
<input type="checkbox"/> L	<27%	≥27%	≥30%	≥34%	≥37%	≥50%	≥75%	≥115%	≥150%	≥188%
<input type="checkbox"/> XL	<27%	≥27%	≥30%	≥35%	≥38%	≥55%	≥80%	≥123%	≥160%	≥200%
<input type="checkbox"/> 	<28%	≥28%	≥32%	≥36%	≥40%	≥60%	≥85%	≥131%	≥170%	≥213%

Water heating energy efficiency under colder and warmer climate conditions

Colder: ③ - 0.2 x ② = %

Warmer: ③ + 0.4 x ② = %

The energy efficiency of the package of products provided for in this fiche may not correspond to its actual energy efficiency once installed in a building, as this efficiency is influenced by further factors such as heat loss in the distribution system and the dimensioning of the products in relation to building size and characteristics.

AD-3000747-01

- I The value of the water heating energy efficiency of the combination heater, expressed in %.
- II The value of the mathematical expression $(220 \cdot Q_{ref})/Q_{nonsol}$, where Q_{ref} is taken from Regulation EU 811/2013, Annex VII Table 15 and Q_{nonsol} from the product fiche of the solar device for the declared load profile M, L, XL or XXL of the combination heater.
- III The value of the mathematical expression $(Q_{aux} \cdot 2,5)/(220 \cdot Q_{ref})$, expressed in %, where Q_{aux} is taken from the product fiche of the solar device and Q_{ref} from Regulation EU 811/2013, Annex VII Table 15 for the declared load profile M, L, XL or XXL.

© Copyright

All technical and technological information contained in these technical instructions, as well as any drawings and technical descriptions supplied, remain our property and shall not be multiplied without our prior consent in writing. Subject to alterations.

Baxi Customer Support



0344 871 1545

Opening hours

Monday - Friday, 8.00am-6.00pm

Weekends and Bank Holidays, 8.30am-2.00pm

Please note calls may be recorded for training and monitoring purposes



baxi.co.uk

Register now to activate your warranty:

www.baxi.co.uk/registration

For the warranty to be maintained, please make sure...

- 1 Benchmark checklist is completed
- 2 Warranty is registered within 30 days
- 3 The boiler has an annual service

For full terms and conditions, visit www.baxi.co.uk/terms. Failure to adhere to terms and conditions will void your manufacturer's warranty.



Baxi
Brooks House,
Coventry Road,
Warwick, CV34 4LL

**UK
CA
0086**



Please ensure the boiler is installed in accordance with these installation instructions and that you adhere to the Building Regulations.



e&oe

All descriptions and illustrations provided in this document have been carefully prepared but we reserve the right to make changes and improvements in our products which may affect the accuracy of the information contained in this leaflet. All goods are sold subject to our standard Conditions of Sale which are available on request.

BAXI