



Glider Compact 330AX
Art. 9670908-04

EN Operator's manual
Electric Lawnmower

FLYMO Electric Lawnmower

Glider Compact 330AX

1. SAFETY	2
2. ASSEMBLY	5
3. OPERATION	6
4. MAINTENANCE	8
5. STORAGE	9
6. TROUBLESHOOTING	10
7. TECHNICAL DATA	12
8. ACCESSORIES	12
9. SERVICE/WARRANTY	13

The initial language of these instructions is English. Other language versions are translations of the initial instructions.

 This product may be used under supervision, or if instruction regarding the safe use of the product has been provided and the resulting dangers have been understood, by children aged 8 and above, as well as by persons with physical, sensory or mental

disabilities or a lack of experience and knowledge. Children must not be allowed to play with the product. Cleaning and user maintenance must not be performed by children without supervision. The use of this product by young people under the age of 16 is not recommended.

Intended use:

The FLYMO Electric Lawnmower is used to cut lawn in private domestic gardens and allotments. The product is not intended for long term use.

 **WARNING! Risk of injury!**
Do not use the product to cut bushes, hedges, shrubs, to cut of climbers or grass on roofs or balcony boxes, to chop up branches, twigs and to level irregularities in the soil. Do not use the product on a slope steeper than 20° maximum.

1. SAFETY

IMPORTANT!

Read the operator's manual carefully before use and keep for future reference.

Symbols on the product:

 **CAUTION!**

If not used properly this product can be dangerous. The warnings and safety instructions must be followed to ensure reasonable safety and efficiency in using this product. The operator is responsible for following the warnings and instructions in this manual and on the product. Never use the product unless the guards provided by the manufacturer are in the correct position. Careless or incorrect use of this product can result in injury to the user or others. Read and understand the content of the operator's manual. Keep the manual for future reference.



Read operator's manual.



Keep other persons away.



Beware of sharp blades. Blades continue to rotate after the engine is switched off.

Disconnect the mains cable before you do maintenance or if the cable becomes damaged or cut.



Keep the mains cable away from the cutting blades.

General safety instructions

Electrical safety

 **WARNING! Electric shock!**

Risk of injury due to electric shock.

→ The product must be supplied through a residual current device (RCD) having a rated residual operating current not exceeding 30 mA.

 **WARNING! Electric shock!**

Risk of injury due to electric shock.

Disconnect the product from the mains before you do maintenance or you replace parts. Thereby the disconnected socket must be in the visual range.

Cables

If extension cables are used, these must comply with the minimum cross-sections in the table below:

Voltage	Cable length	Cross section
220 – 240 V / 50 Hz	Up to 40 m	1.0 mm ²
220 – 240 V / 50 Hz	Up to 60 m	1.5 mm ²
220 – 240 V / 50 Hz	Max. 100 m	2.5 mm ²

Minimum rating:

1.0 mm² size cable, 10 amps 250 volts AC.

Your product is supplied with cable wired directly into the product.

1. If the supply cord is damaged, it must be replaced by your local Husqvarna UK Ltd. Approved Service Centre or similarly qualified persons in order to avoid a hazard.
2. Flymo Extension Cables are available from your local Husqvarna UK Ltd. Approved Service Centre.
3. Do not wire an extension cable directly to your product yourself. Please contact your local Husqvarna UK Ltd. Approved Service Centre for further information on the connectors and kits available.
4. Only use extension cables specifically designed for outdoor use and which conform to one of the following specifications: Ordinary rubber (60245 IEC 53), Ordinary PVC (60227 IEC 53) or Ordinary PCP (60245 IEC 57).

Connectors – Important

- Flymo connectors are suitable for use with 2 core cable only. Under no circumstances should these connectors be used for earthed products.
- All Flymo connectors and cables are of splashproof construction. They are not waterproof and must not be left outside permanently nor should they be submerged or immersed in water. Do not let cable lay or trail through pools of water or splashed with water from hose pipes.

Mains plug replacement – Important

- **If the plug supplied is cut off it should be destroyed. There is an electric shock hazard if a cut off plug is inserted into a 13 amp socket.**
1. No earth required. Flymo products are double insulated to EN60335 and under no circumstances should an earth be connected to any part of the product.
 2. **Ensure the mains voltage suits your product.**
 3. **Important!** The wires in the mains lead are coloured in accordance with the following code: BLUE – NEUTRAL; BROWN – LIVE.
The wire which is coloured BLUE must be connected to the Terminal which is marked with the letter 'N' or coloured BLACK. The wire which is coloured BROWN must be connected to the Terminal which is marked with the letter 'L' or coloured RED.
 4. It is important that the outer sheath is clamped correctly into the 3-pin plug.
 5. If in doubt consult your local Service Repairer or qualified electrician before the machine is used.

6. A 13 Amp fuse must be fitted to the Mains Plug.

7. The normal plug fuse and household fuse only protect the electrical equipment and are not a safeguard against electrocution.

Training

1. Read the instructions carefully. Be familiar with the controls and the correct use of the machine.
2. Never allow children or people unfamiliar with these instructions to use the machine. Local regulations can restrict the age of the operator.
3. Never operate the machine while people, especially children, or pets are nearby.
4. Keep in mind that the operator or user is responsible for accidents or hazards occurring to other people or their property.

Preparation

1. While operating the machine always wear substantial footwear and long trousers. Do not operate the machine when barefoot or wearing open sandals. Avoid wearing clothing that is loose fitting or that hanging cords or ties.
2. Thoroughly inspect the area where the machine is to be used and remove all objects which can be thrown by the machine.
3. Before using, always visually inspect to see that the blade, blade bolt and the blade assembly are not worn or damaged. Replace worn or damaged components in set to preserve balance. Replace damaged or unreadable labels.
4. Before use check the supply and extension cord for signs of damage or ageing. If the cord becomes damaged during use, disconnect the cord from the supply immediately. **DO NOT TOUCH THE CORD BEFORE DISCONNECTING THE SUPPLY.** Do not use the machine if the cord is damaged or worn.

Operation

1. Operate the machine only in daylight or in good artificial light.
2. Avoid operating the machine in wet grass.
3. Always be sure of your footing on slopes.
4. Walk, never run.
5. Mow across the face of slopes, never up and down.
6. Exercise extreme caution when changing direction on slopes.
7. Do not mow excessively steep slopes.
8. Use extreme caution when reversing or pulling the machine towards you.
9. Stop the blade(s) if the machine has to be tilted for transportation when crossing surfaces other than grass, and when transporting the machine to and from area to be used.
10. Never operate the machine with defective guards or shields, or without safety devices, for example defectors and/or grass collector, in place.
11. Switch on the motor carefully according to instructions and with feet well away from the blade(s).
12. Do not tilt the machine when switching on the motor, except if the machine has to be tilted for starting. In

this case, do not tilt it more than absolutely necessary and lift only the part, which is away from the operator.

13. Do not start the machine when standing in front of the discharge opening.
 14. Do not put hands or feet near or under rotating parts. Keep clear of the discharge opening at all times.
 15. Do not transport the machine while the power source is running.
 16. Stop the machine, and remove the plug from the socket. Make sure that all moving parts have come to a complete stop
 - whenever you leave the machine,
 - before clearing blockages or unclogging chute,
 - before checking, cleaning or working on the machine,
 - after striking a foreign object. Inspect the machine for damage and make repairs before restarting and operating the machine;
- if the machine starts to vibrate abnormally (check immediately)
- inspect for damage,
 - replace or repair any damaged parts,
 - check for and tighten any loose parts.

Maintenance and storage

1. Keep all nuts, bolts, and screws tight to be sure the machine is in safe working condition.
2. Check the grass collector frequently for wear or deterioration.
3. On machines with multi blade, take care as rotating one blade can cause other blades rotate.
4. Be careful during adjustment of the machine to prevent entrapment of the fingers between moving blades and fixed parts of the machine.
5. Always allow the machine to cool down before storing.
6. When servicing the blades be aware that, even though the power source is switched off, the blades can still be moved.
7. Replace worn or damaged parts for safety. Use only genuine replacement parts and accessories.

Additional safety instructions

Electrical safety



WARNING! Cardiac arrest!

This product makes an electromagnetic field while it operates. This field may under some conditions interfere with active or passive medical implants. To decrease the risk of conditions that can possibly injure or kill, we recommend persons with medical implants to speak with their physician and the medical implant manufacturer before you operate the product.

Before use, examine the cable for signs of damage or ageing. If the cable is found to be defective, take the product to an Authorised Service Centre and have the cable replaced.

Do not use the product if the electric cables are damaged or worn.

Immediately disconnect from the mains if the cable is cut, or the insulation is damaged. Do not touch the electric cable until the cable has been disconnected. Do not repair a cut or damaged cable. Replace it with a new one.

The extension cable must be uncoiled. Coiled cables can overheat and reduce the efficiency of your mower.

Keep the extension cable away from product, always work away from the power point mowing up and down, never in circles.

Do not pull cable around sharp objects.

Always switch off at the mains before disconnecting any plug, cable connector or extension cable.

Stop the engine, disconnect the mains and examine the cable for damage or ageing before you wind the cable for storage. Do not repair a damaged cable, replace it with a new one. Use only genuine replacement cable.

Always wind the cable carefully, avoid kinking.

Do not carry the product by the cable.

Do not pull on the cable to disconnect any of the plugs.

Use only on AC mains supply voltage shown on the product rating label.

Our products are double insulated to EN60335. Do not connect an earth to any part of the product.

Check the working area for hidden cables.

Do not use for pond care or close to water.

Personal safety



WARNING! Risk of suffocation!

Small parts can be easily swallowed. There is also a risk that the polybag can suffocate toddlers. Keep toddlers away when you assemble the product.

Do not use in explosive atmosphere.

Do not operate the product when you are tired, ill or under the influence of alcohol, drugs or medicine or you exhausted.

Do not overload the mower.

Use gloves, wear slip resistant shoes and wear eye protection.

Do not use under wet conditions.

Do not use on wet grass.

Do not disassemble the product further than the delivery status.

Only start the mower with an upright standed handle.

Do not use the start levers alternately.

Use the handles carefully.

Safety Cut-Out

The engine is protected by a Safety Cut-Out which is activated when the blade becomes jammed or if the engine is overloaded. When this occurs, stop and disconnect the product from the mains. The Safety Cut-Out will only reset when you release the start/stop lever. Clear any obstruction and wait for a few minutes for the Safety Cut-Out to reset before you continue to use the product.

2. ASSEMBLY



WARNING! Risk of physical injury!

Cut injury when the blade turns or the product starts accidentally.

→ **Wait for the blade to stop, disconnect the product from the mains and use gloves before you do assembly.**

To assemble the grass box:

1. Push the grass box handle ② into the grass box cover ① until the connections click.

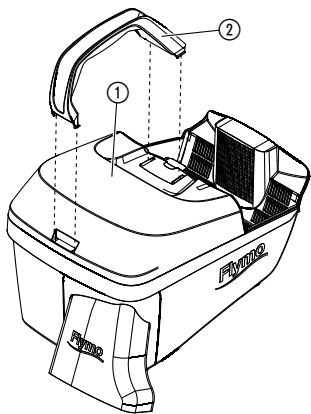

2. Put the grass box lid ③ in the mower body ④.

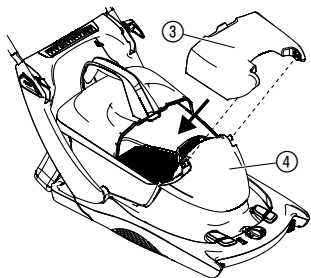

3. OPERATION



WARNING! Risk of physical injury!

Cut injury when the blade turns or the product starts accidentally.

- Wait for the blade to stop, disconnect the product from the mains and use gloves before you connect or transport the product.

To connect the mower:

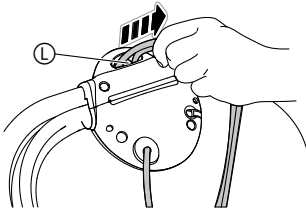

WARNING! Risk of electric shock!

To avoid damage to the mains cable, the mains cable must be inserted into the cable lock ①.

- Before you operate insert the mains cable into the cable lock ①.

1. Loop the mains cable, insert the loop into the cable lock ① and pull tight.
2. Connect the mains cable into a 230 V mains socket.

To start the mower:

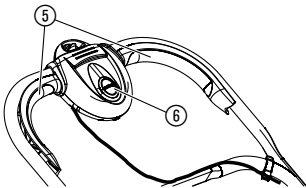

WARNING! Risk of physical injury!

Risk of injury if the product does not stop when you release the start lever.

- Do not bypass the safety devices or switches.
For example do not attach the start lever ⑤ to the handle.

To start:

The product is fitted with a two-handed safety device (start lever ⑤ with safety interlock ⑥) to prevent the product from being turned on by accident.

There are two start levers ⑤ fitted. Either one have to be used to start.

1. Connect the mains cable into a 230 V mains socket.
2. Push the safety interlock ⑥ with one hand and pull the start lever ⑤ with the other hand.
3. Release the safety interlock ⑥.
The product will start.

To stop:

- Release the start lever ⑤.

To adjust the cutting height:

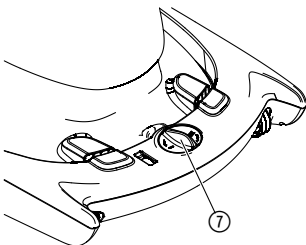

The cutting height can be adjusted from 12 to 32 mm in 4 positions.

1. Turn the adjust knob ⑦ counterclockwise to lower the cutting height.
2. Turn the adjust knob ⑦ clockwise to increase the cutting height.

To use the mower with the grass box:

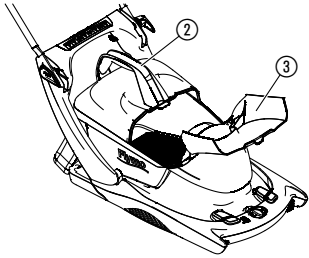

To use the mower without the grass box:

Tips to use the mower:

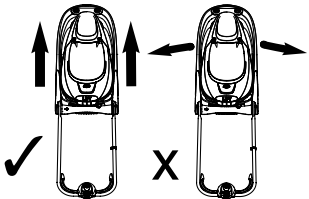
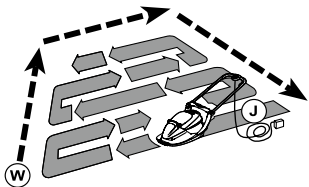

WARNING! Risk of physical injury!

Cut injury when the blade turns or the product starts accidentally.

→ **Wait for the blade to stop, disconnect the product from the mains and use gloves before you put / remove the grass box.**

→ **Do not put your hands in the discharge opening.**

1. Open the lid ③.
2. Put the grass box into the product by the handle ②.
3. Close the lid ③.
4. Make sure that the grass box is securely connected.
5. Start the product.

The transparent lid ③ shows the filling level of the grass box.

6. Stop the product when the grass box is filled completely.
7. Open the lid ③.
8. Remove the grass box of the product by the handle ②.
9. Empty the grass box.

For larger areas of grass where grass collection is not required you can use the product without the grass box. The cut grass drop on the lawn.

1. Open the lid ③.
2. Remove the grass box of the product by the handle ②.
3. Close the lid ③.

1. Mow twice a week during the growing season. The lawn will suffer if more than a third of its length is cut at one time and this may also result in poor collection.
2. For the best results mow the outside edge of the lawn in a clockwise direction first.
3. Start to mow the edge of the lawn nearest to the power point. So the cable is laid out on the lawn you have already cut.
4. For best grass collection always mow in a straight line. Do not swing the lawnmower from side to side.
5. For the best cutting results mow in straight lines with an overlap of approximately 8 – 10 cm on each pass with the mower.
6. Do Not overload the mower.

To mow long thick grass may cause the motor speed to drop and you will hear a change in the motor sound. If the motor speed drops you may overload the mower which may cause damage. When you mow in long thick grass a first cut with the cutting height set higher will help reduce the load. See adjusting the cutting height.

4. MAINTENANCE



WARNING! Risk of physical injury!

Cut injury when the blade turns or the product starts accidentally.

→ **Wait for the blade to stop, disconnect the product from the mains and use gloves before you do maintenance.**

To clean the product:



WARNING! Electric shock!

Risk of injury and risk of damage to the product.

→ **Do not clean the product with water or with a water jet (in particular high-pressure water jet).**

To clean the underside of the product:

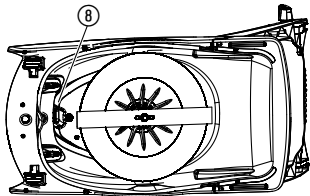

The underside is easiest to clean after you mowed.

Use gloves.

1. Lay the product on its side carefully.
2. Clean the underside, the blade and the airflow slots ⑧ with a brush (do not use sharp objects).

To clean the overside of the product and the grass box:

Do not clean with chemicals including petrol or solvents. Some can destroy critical plastic parts.

1. Clean the overside with a damp cloth.
2. Clean the air intakes and the grass box with a soft brush (do not use sharp objects).

5. STORAGE

To put into storage:

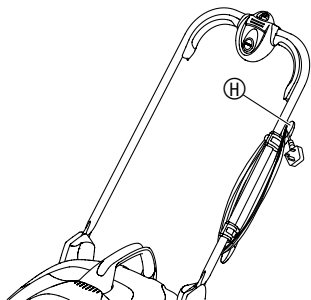
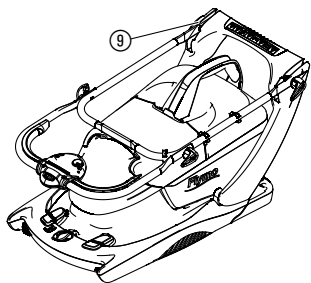

Disposal:
(in accordance with
RL2012/19/EC)



The product must be stored away from children.

1. Disconnect the product from the mains.
2. Clean the product (see Maintenance).
3. To save space, push the push button ⑨ until the joints can be folded together easily.
4. Wind the cable around the cable hooks (To release the cable pull the hook ⑧ away from the handle).
5. Store the product in a dry, enclosed and secure place.

The product must not be disposed of to normal household waste. It must be disposed of in line with local environmental regulations.

IMPORTANT!

Dispose of the product through or via your municipal recycling collection centre.

6. TROUBLESHOOTING



WARNING! Risk of physical injury!

Cut injury when the blade turns or the product starts accidentally.

→ **Wait for the blade to stop, disconnect the product from the mains and use gloves before you do troubleshooting.**

To clean the bumper:

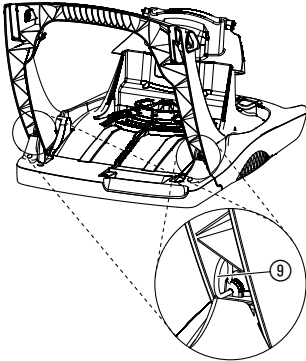

Clean the bumper when the adjust knob (7) locks.

1. Remove the 2 R-clips (9) of the handle locks on both sides.
2. Turn the adjust knob (7) to level **1**.
3. Tilt the lower handle (10) forward.
4. Remove the bumper (11) of the mower body (4).
5. Clean the bumper (11).
6. Assemble the bumper (see Assembly).

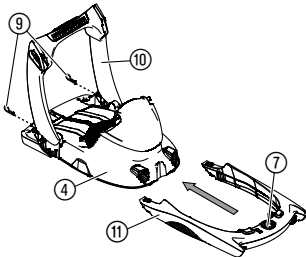

To replace the blade:



WARNING! Risk of physical injury!

Cut injury when the blade turns and it is damaged, bent, out of balance or has chipped edges.

→ **Do not use the product when the blade is damaged, bent, out of balance or has chipped edges.**

→ **Do not regrind the blade.**

The FLYMO spare parts are available from your FLYMO dealer or from the FLYMO service.

Only use an original FLYMO blade:

- **FLYMO replacement blade reference no. FLY070.**
Part no. 5898064-90.

→ Let the blade replace by the FLYMO Service or a specialist dealer authorised by FLYMO.

Problem	Possible Cause	Remedy
Engine does not start	Extension cable is disconnected or damaged.	→ Connect the extension cable or if necessary replace it.
	Blade is blocked.	→ Remove the obstacle.
Engine is jammed and makes a noise	Blade is blocked.	→ Remove the obstacle.
	Cutting height is too low.	→ Raise the cutting height.
Loud noises, the mower is rattling	Screws on engine, its fixing or on the mower chasing are loose.	→ Have screws tightened by an authorised specialist dealer or the FLYMO Service.
Mower runs unevenly or vibrates strongly	Blade is damaged or the blade mounting is released.	→ Have blade tightened or replaced by an authorised specialist dealer or the FLYMO Service.
	Blade is very dirty.	→ Clean the mower (see 4. MAINTENANCE). If this does not rectify the problem, contact the FLYMO Service.
The adjust knob is locked	The bumper is dirty.	→ Clean the bumper.
Poor grass collection	Lid is not correct in place.	→ Put the lid correct on the grass box.
	Airflow slots are dirty.	→ Clean the mower (see 4. MAINTENANCE).
Lawn is not cleanly cut.	Blade is blunt or damaged.	→ Have blade replaced by the FLYMO Service.
	Cutting height is too low.	→ Raise the cutting height.



NOTE: For other malfunctions speak to the FLYMO servicing department. Repairs must only be done by FLYMO servicing departments or specialist dealers approved by FLYMO.

7. TECHNICAL DATA

<i>Electric Lawnmower</i>	Unit	Value (Art. 330AX)
Rated Power	W	1700
Mains voltage	V	230
Mains frequency	Hz	50
Speed of rotation cutting blade	R/min.	4200
Cutting width	cm	33
Cutting height adjustment (4 positions)	mm	12 – 32
Volume of grass box	l	22
Weight	kg	10.5
Sound pressure level L_{pA} ¹⁾ Uncertainty k_{pA}	dB (A)	89 3
Sound power level L_{WA} ²⁾ : measured/guaranteed Uncertainty k_{WA}	dB (A)	91 / 93 1.93
Hand/arm vibration a_{vhw} ¹⁾ Uncertainty k_a	m/s^2	< 2.5 1.5

Measuring process complying with: ¹⁾ EN 60335-2-77 ²⁾ RL 2000/14/EC



NOTE: The stated vibration emission value has been measured according to a standardized test procedure and can be used for comparison of one electric power tool with another. It can also be used for preliminary evaluation of exposure. The vibration emission value can vary during actual use of the electric power tool.

8. ACCESSORIES

FLYMO replacement blade

As replacement for blunt blade.

Reference no. FLY070
Part no. 5898064-90

9. SERVICE/WARRANTY

Service:

Please contact the address on the back page.

Warranty:

In the event of a warranty claim, no charge is levied to you for the services provided.

Husqvarna UK Ltd. offers a 1-year warranty for this product (from the date of purchase) if the product has been used exclusively for private purposes. This manufacturer's warranty does not apply to used products purchased from a secondary market. This warranty includes all significant defects of the product that can be proved to be material or manufacturing faults. This warranty is fulfilled by supplying a fully functional replacement product or by repairing the faulty product sent to us free of charge; we reserve the right to choose between these options. This service is subject to the following provisions:

- The product was used for its intended purpose as per the recommendations in the operating instructions.
- Neither the purchaser nor a third party has attempted to repair the product.

- Only original FLYMO spare and wear parts were used.

Normal wear and tear of parts and components, optical changes, as well as wear parts and consumables, are excluded from the warranty.

This manufacturer's warranty does not affect warranty entitlements against the dealer/retailer.

If problems arise with this product, please contact our Service department. In the event of a warranty claim, please send the defective product together with a copy of the purchase receipt and a description of the defect, sufficiently stamped, to the Husqvarna service address on the back page.

Consumables:

The blade is a consumable and is not included in the warranty.

PRODUCT LIABILITY

In accordance with the German Product Liability Act, we hereby expressly declare that we accept no liability for damage incurred from our products where said products have not been properly repaired by a FLYMO-approved service partner or where original FLYMO parts or parts authorised by FLYMO were not used.

EC DECLARATION OF CONFORMITY

The undersigned, Husqvarna AB, 561 82 Huskvarna, Sweden, hereby certifies that, when leaving our factory, the products indicated below are in accordance with

the harmonised EU guidelines, EU standards of safety and product specific standards. This certificate becomes void if the products are modified without our approval.

Description of the product:	Electric Lawnmower
Product type	Glider Compact 330AX
Article-Number	9670908-04
CE-Directives	2006/42/EC 2014/30/EC 2000/14/EC 2011/65/EC
Harmonised EN	EN ISO 12100 EN 60335-1 EN 60335-2-77
Deposited Documentation	GARDENA Technical Documentation, M. Kugler, Hans-Lorenser-Str. 40, 89079 Ulm
Conformity Assessment according to	2000/14/EG Procedure: Art. 14 Annex VI
Noise level: measured / guaranteed	91 dB (A)/93 dB (A)
Year of CE marking:	2017
Ulm, 07.12.2017	
Authorised representative:	 John Thompson Product and Marketing Director EUAP

Deutschland / Germany
GARDENA Manufacturing GmbH
Central Service
Hans-Lorenser-Straße 40
D-89079 Ulm
Produktfragen:
(+49) 731 490-123
Reparaturen:
(+49) 731 490-290
service-flymo@gardena.com

Albania
COBALT Sh.p.k.
Rr. Siri Kodra
1000 Tirana

Argentina
Husqvarna Argentina S.A.
Av. del Libertador 5954 –
Piso 11 – Torre B
(C1428ARP) Buenos Aires
Phone: (+54) 11 5194 5000
info.gardena@ar.husqvarna.com

Armenia
Garden Land Ltd.
611 Tigran Mets
0005 Yerevan

Australia
Husqvarna Australia Pty. Ltd.
Locked Bag 9
Central Coast BC
NSW 2252
Phone: (+61) (0) 2 4352 7400
customer.service@
husqvarna.com.au

Austria / Österreich
Husqvarna Austria GmbH
Industriezeile 36
4010 Linz
Tel.: (+43) 732 77 01 01-485
service.gardena@
husqvamagroup.com

Azerbaijan
Firm Progress
a. Aliyev Str. 26A
1052 Bakı

Belgium
Husqvarna België nv/sa
Gardena Division
Rue Egide Van Opheim 111
1180 Uccle/Ukkel
Tel.: (+32) 2 720 92 12
Mail: info@gardena.be

Bosnia / Herzegovina
SILK TRADE d.o.o.
Industrijska zona Bukva bb
74260 Tešanj

Brazil
Husqvarna do Brasil Ltda
Av. Francisco Matarazzo,
1400 – 19º andar
São Paulo – SP
CEP: 05001-903
Tel: 0800-112252
marketing.br.husqvarna@
husqvarna.com.br

Bulgaria
AGROLAND България АД
бул. 8 Декември, № 13
Офис 5
1700 Студенски град
София
Tel.: (+359) 24666910
info@agroland.eu

Canada / USA
GARDENA Canada Ltd.
100 Summerlea Road
Brampton, Ontario L6T 4X3
Phone: (+1) 905 792 93 30
info@gardenacanada.com

Chile
Maquinarias Agroforestales
Lida. (Maga Ltda.)
Santiago, Chile
Avda. Chesterton
8355 comuna Las Condes
Phone: (+56) 2 202 4417
Dalton@maga.cl
Zipcode: 7560330

China
Husqvarna (China) Machinery
Manufacturing Co., Ltd.
No. 1355, Jia Xin Rd.,
Ma Lu Zhen, Jia Ding Dist.,
Shanghai
201801
Phone: (+86) 21 59159629
Domestic Sales
www.gardena.com.cn

Colombia
Husqvarna Colombia S.A.
Calle 18 No. 68 D-31, zona
Industrial de Montevideo
Bogotá, Cundinamarca
Tel. 571 2922700 ext. 105
jairo.salazar@husqvarna.com.co

Costa Rica
Compania Exim
Euroiberoamericana S.A.
Los Colegios, Moravia,
200 metros al Sur del Colegio
Saint Francis – San José
Phone: (+506) 297 68 83
exim_euro@racsca.co.cr

Croatia
SILK ADRIA d.o.o.
Josipa Lončara 3
10090 Zagreb
Phone: (+385) 1 3794 580
silk.adria@zg.t-com.hr

Cyprus
Med Marketing
17 Digeni Akrita Ave
P.O. Box 27017
1641 Nicosia

Czech Republic
Husqvarna Česko s.r.o.
Türkova 2319/5b
149 00 Praha 4 – Chodov
Bežplatná infolinika :
800 100 425
servis@cz.husqvarna.com

Denmark
GARDENA DANMARK
Lejrevej 19, st.
3500 Værløse
Tlf.: (+45) 70 26 47 70
husqvarna@husqvarna.dk
www.gardena.com / dk

Dominican Republic
BOSQUESA, S.R.L.
Carretera Santiago Licey
Km. 5 ½
Esquina Copal II,
Santiago
Dominican Republic
Phone: (+809) 736-0333
joserbosquesa@claro.net.do

Ecuador
Husqvarna Ecuador S.A.
Arupos E1-181 y 10 de
Agosto Quito, Pichincha
Tel: (+593) 22800739
francisco.jacom@
husqvarna.com.ec

Estonia
Husqvarna Eesti OÜ
Gardena Division
Valdeku 132
Tallinn
11216, Estonia
info@gardena.ee

Finland
Oy Husqvarna Ab
Gardena Division
Lautatarhankatu 8 B / PL 3
00581 HELSINKI
info@gardena.fi

France
Husqvarna France
9/11 Allée des pierres mayettes
92635 Genevilliers Cedex
France
http://www.gardena.com/ fr
N° AZUR: 0 810 00 78 23
(Prix d'un appel local)

Georgia
ALD Group
Beliashvili 8
1159 Tleilisi

Great Britain
Husqvarna UK Ltd
Preston Road
Aycliffe Industrial Park
Newton Aycliffe
County Durham
DL5 6UP
Phone: +44 (0) 344 8444558
customer.services@
husqvarna.co.uk

Greece
Π.ΠΑΠΑΔΟΠΟΥΛΟΣ ΑΕΒΕ
Αβρύς, Αβρύων 92
Αβρύς
Τ.Κ. 104 42
ΕΛΛΑΔΑ
Τηλ., (+30) 210 5193 100
info@papadopoulou.com.gr

Hungary
Husqvarna Magyarországi Kft.
Ezred u. 1-3
1044 Budapest
Telefon: (+36) 1 251-4161
vevoszolgalt.husqvarna@
husqvarna.hu

Iceland
Ó. Johnson & Kaaber
Tunguhalsi 1
110 Reykjavík
ooj@ojk.is

Ireland
Husqvarna UK Ltd
Preston Road
Aycliffe Industrial Park
Newton Aycliffe
County Durham
DL5 6UP
info.gardena@husqvarna.co.uk

Italy
Husqvarna Italia S.p.A.
Via Santa Vecchia 15
23868 VALMADRERA (LC)
Phone: (+39) 0341.203.111
assistenza.italia@
it.husqvarna.com

Japan
KAKUICHI Co. Ltd.
Sumitomo Realty &
Development Kojimachi
BLDG. 8F
5-1 Nibanncyo
Chiyo-da-ku
Tokyo 102-0084
Phone: (+81) 33 264 4721
m_ishihara@kaku-ichi.co.jp

Kazakhstan
LAMED Ltd.
155/1, Tazhibayevoi Str.
050060 Almaty
IP Schmidt
Abayaveina 3B
110 005 Kostanay

Korea
Kyung Jin Trading CO.,LTD.
107-4, SunDuk Bid.,
YangJae-dong,
Seochu-gu,
Seoul, (zipcode: 137-891)
Phone: (+82) (0)2 574-6300

Kyrgyzstan
Alye Maki
av. Moladaya Guardir J 3
720014
Bishkek

Latvia
Husqvarna Latvija SIA
Gardena Division
Ulbrokas 19A
LV-1021 Riga
http://www.gardena.lv

Lithuania
UAB Husqvarna Lietuva
Gardena Division
Atleities pl. 77C
LT-52104 Kaunas
info@gardena.lt

Luxembourg
Magasins Jules Neuberg
39, rue Jacques Stas
Luxembourg-Gasperich 2549
Case Postale No. 12
Luxembourg 2010
Phone: (+352) 40 14 01
api@neuberg.lu

Mexico
AFOSA
Av. Lopez Mateos Sur # 5019
Col. La Gama 45070
Zapopan, Jalisco, Mexico
Phone: (+52) 33 3818-3434
icornejo@afosa.com.mx

Moldova
Convel S.R.L.
290A Muncesti Str.
2002 Chisinau

Netherlands
Husqvarna Nederland B.V.
GARDENA Division
Postbus 50131
1305 AC ALMERE
Phone: (+31) 36 521 00 10
info@gardena.nl

Neth. Antilles
Jonka Enterprises N.V.
Sta. Rosa Weg 196
P.O. Box 8200
Curaçao
Phone: (+599) 9 767 66 55
pgm@jonka.com

New Zealand
Husqvarna New Zealand Ltd.
PO Box 76-437
Manukau City 2241
Phone: (+64) (0) 9 9202410
support.nz@husqvarna.co.nz

Norway
Husqvarna Norge AS
Gardena Division
Traskemoen 36
1708 Sarpsborg
Tel: 69 10 47 00
www.gardena.no

Peru
Husqvarna Perú S.A.
Jr. Ramón Cárcamo 710
Lima
Tel: (+51) 1 3320400 ext. 416
juan.remuzgo@husqvarna.com

Poland
Husqvarna
Poland Spółka z o.o.
ul. Wysockiego 15 b
03-371 Warszawa
Phone: (+48) 22 330 96 00
gardena@husqvarna.com.pl

Portugal
Husqvarna Portugal, SA
Lagoa - Albarraque
2635 - 595 Rio de Mouro
Tel: (+351) 21 922 85 30
Fax: (+351) 21 922 85 36
info@gardena.pt

Romania
Madex International Srl
Soseaua Odaii 117-123,
RO 013603 Bucuresti, 151
Phone: (+40) 21 352.76.03
madex@ines.ro

Russia / Россия
ООО „Хускарна“
141400, Московская обл.,
г. Железнодорожный,
ул. Ленинградская,
владение 39, стр.6
Бизнес Центр
„Улмис Бизнес Парк“,
помещение 0B02_04
http://www.gardena.ru

Serbia
Domet d.o.o.
Autoput za Novi Sad bb
11273 Belgrade
Phone: (+381) 11 848 8812
miroslav.jejina@domet.rs

Singapore
Hy-Ray PRIVATE LIMITED
40 Jalan Pemimpin
#02-08 Tat Ann Building
Singapore 577185
Phone: (+65) 6253 2277
shiyang@hyray.com.sg

Slovak Republic
Husqvarna Česko s.r.o.
Türkova 2319/5b
149 00 Praha 4 – Chodov
Bežplatná infolinika:
800 154 044
servis@sk.husqvarna.com

Slovenia
Husqvarna Austria GmbH
Industriezeile 36
4010 Linz
Tel.: (+43) 732 77 01 01-485
service.gardena@
husqvamagroup.com

South Africa
Husqvarna
South Africa (Pty) Ltd
Postnet Suite 250
Private Bag X6,
Cascades, 3202
South Africa
Phone: (+27) 33 846 9700
info@gardena.co.za

Spain
Husqvarna España S.A.
Calle de Rivas nº 10
28052 Madrid
Phone: (+34) 91 708 05 00
atencioncliente@gardena.es

Suriname
Agrofix n.v.
Verfengde Hoogstraat #22
Phone: (+597) 472426
agrofix@sr.net
Pobox : 2006
Paramaribo
Suriname – South America

Sweden
Husqvarna AB
Gardena Division
S-561 82 Huskvarna
info@gardena.se

Switzerland / Schweiz
Husqvarna Schweiz AG
Consumer Products
Industriestrasse 14
5506 Mägenwil
Phone: (+41) (0) 62 887 37 90
info@gardena.ch

Turkey
GARDENA Dost Diş Ticaret
Müessesilik A.Ş.
Sanayi Cad. Adil Sokak
No: 1/B Kartal
34873 Istanbul
Phone: (+90) 216 38 93 939
info@gardena-dost.com.tr

Ukraine / Україна
ТОВ «Хускарна Україна»
вул. Васильківська, 34,
офіс 204-р
03022, Київ
Tel. (+38) 044 498 39 02
info@gardena.ua

Uruguay
FELI SA
Entre Ríos 1083 CP 11800
Montevideo – Uruguay
Tel : (+598) 22 03 18 44
info@felisa.com.uy

Venezuela
Corporación Casa y Jardín C.A.
Av. Caroni, Edif. Trezmen, PB.
Colinas de Bello Monte,
1050 Caracas.
Tlf : (+58) 212 992 33 22
info@casayjardin.net.ve

AX330-20.960.03/0918
596868401
Husqvarna AB
S-561 82 Huskvarna
Sweden

