

Installation Instructions & Operating Manual

Model Number: 1668

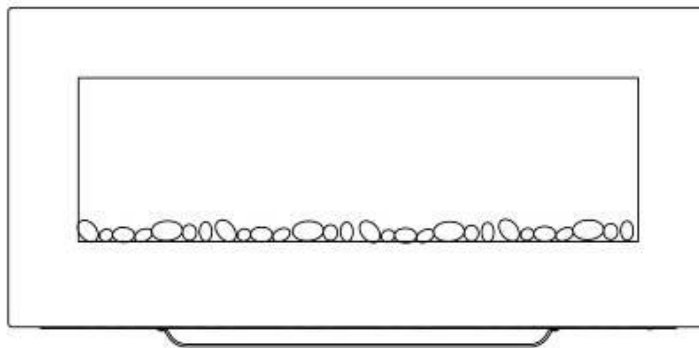

Wall-Hanging Mode

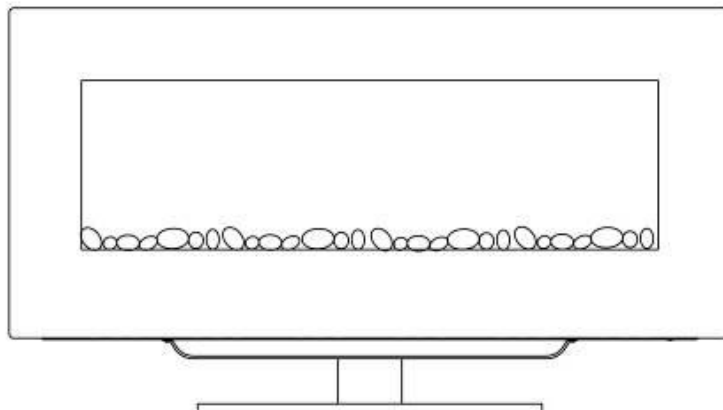

Free-Standing Mode

**Please read the instructions carefully before installation or
use of this electric fire and retained for future reference.**

Contents

Important Notes	3 - 4
Technical Specification	5
Parts List	6
Fire Installation	7 - 12
Operation by Manual Control	13
Operation by Remote Handset	14 – 19
Remote Control Battery Replacement	20
Maintenance	21
Electric Fire Guarantee	22
General Information	23

IMPORTANT NOTES

Read all of the instructions carefully before using the appliance.

- **For indoor use only. Do not use outdoors.** This appliance is only suitable for well insulated spaces or occasional use.
- If the fire is to be placed in front of an existing chimney opening and there is any risk of chimney debris falling down onto the fire or drafts from the chimney it is recommended that the flue or opening is sealed off with non-combustible non-fibrous insulation materials. Do not place into an existing fireplace that is prone to dampness. Should it be necessary to cap and seal the chimney to prevent personal injury, a professional should be hired to do the work
- Do not use this appliance in the immediate surroundings of a bath, a shower or a swimming pool.
- Do not use this fire as a free-standing appliance. It must always be fixed to a wall, fireplace mantel or floor etc.
- This fire must not be located immediately below a socket outlet.
- This appliance must not be supplied through an external switching device such as a timer, or connected to the circuit that is regularly switched on and off by utility in order to avoid a hazard due to the inadvertent resetting of the thermal cut out.
- A non-rewireable plug fitted with a 13A fuse is supplied. Should the fuse or plug need replacing, and you are competent to do so, it must be replaced with a 13A fuse or plug being 13A BS1363A approved.
- If the power cord is damaged, it must be repaired by the manufacturer, its authorised service centre or professional person.
- Do not cover warning: In order to avoid overheating, do not cover the appliance. 
- To reduce the risk of fire, keep textiles, curtains, or any other flammable material a minimum distance of 1 meter from the air outlet.
- Keep the power cord away from hot surfaces and hot conditions. Do not route the power lead in front of the appliance.
- Do not use this fire in rooms that have explosive gas in them (for example petrol), or if you are using solvents, glue, aerosol spray or inflammable paints, as these may catch fire.
- This appliance can be used by children aged from 8 years and above and persons with reduced physical, sensory or mental capabilities or lack of experience and knowledge if they have been given supervision or instruction concerning use of the appliance in a safe way and understand the hazards involved.

Important Notes (continued)

- Children and vulnerable people must be supervised at all times when using this appliance, as some parts can become very hot and cause burns.
- Do not use this appliance in small rooms when they are occupied by persons not capable of leaving the room on their own, unless constant supervision is provided.
- Children of less than 3 years should be kept away unless continuously supervised. Children aged from 3 years and less than 8 years shall only switch on / off the appliance provided that it has been placed in its intended normal operating position and they have been given supervision or instruction concerning use of the appliance in a safe way and understand the hazards involved. Children aged from 3 years and less than 8 years shall not plug in, regulate, clean the appliance or perform user maintenance.
- Cleaning and user maintenance shall not be made by children without supervision.
- This appliance shall not be played with by children.
- This appliance must be positioned so that the plug / fused spur is accessible.
- In the event of a fault please disconnect the fire from the mains supply.
- Warning: This appliance must be earthed.
- The wires in the mains lead connected to this appliance are coloured in accordance with the following code:

Green and Yellow: Earth

Blue: Neutral

Brown: Live

As the colour of the wires in the mains lead of this appliance may not correspond with the coloured markings identifying the terminals in your plug, proceed as follows:

The wire which is coloured Green and Yellow must be connected to the terminal in the plug which is marked with the letter E or by the earth symbol or coloured Green or Green and Yellow.

The wire which is coloured Blue must be connected to the terminal which is marked with the letter N or coloured Black.

The wire which is coloured Brown must be connected to the terminal which is marked with letter L or coloured Red.

Technical Specification

Model No.: Solar 2

Supply Voltage: AC 230-240V 50Hz

Maximum Power Consumption: 2kW

Power for Flame Effect: 4.96W (LED 0.96W + Motor for flame 4W)

Power for Mood Light: DC12V,1.44W,0.12A

Heat Output:

Nominal Heat Output (Pnom): 2kW

Minimum Heat Output (indicative) (Pmin): 1kW

Maximum Continuous Heat Output (Pmax): 2kW

Auxiliary Electricity Consumption:

At nominal Heat Output: (elmax): 12.5W

At minimum Heat Output: (elmin): 12W

In standby Mode (elSB): 0.3W

Type of heat output / room temperature control

Single stage heat output and no room temperature control	No
Two or more manual stages, no room temperature control	No
With mechanic thermostat room temperature control	No
With electronic room temperature control	Yes
Electronic room temperature control plus day timer	Yes
Electronic room temperature control plus week timer	Yes

Other Control Options

Room temperature control, with presence detection	No
Room temperature control, with open window detection	Yes
With distance control option	No
With adaptive start control	Yes
With working time limitation	No
With black bulb sensor	No

Parts List

Please unpack carefully ensuring that any loose parts and all packing items are removed. Read any warning labels carefully (see Maintenance Section). Place waste packaging back into box and dispose of RESPONSIBLY.

1. ST4*10 Screws	2pcs
2. Instruction Manual	1pc
3. Remote Control	1pc
4. AAA Battery	2pcs
5. Firebox	1pc
6. Front Glass Panel	1pc
7. Wall Mount Bracket	1pc
8. Thumb Screws	2pcs
9. ST5*40 Wood Screws	4pcs
10. Φ 8*40 Drywall Anchors	4pcs
11. White Pebble Stones	1set
12. Clear Faux Stones	1set

Fire Installation

Dimension

Unit: mm

Portable Size:

Portable Size:

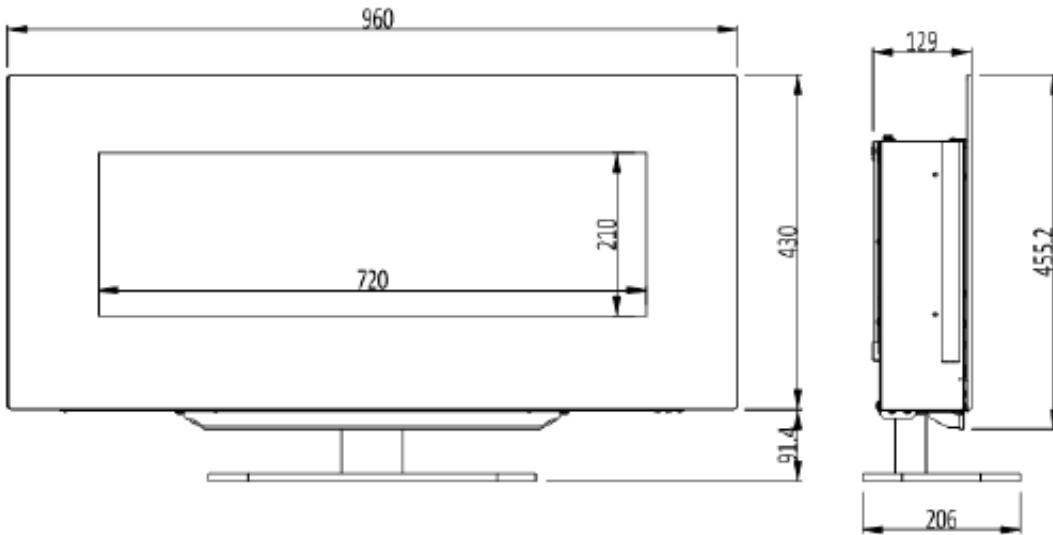

Wall-Mounted Size:

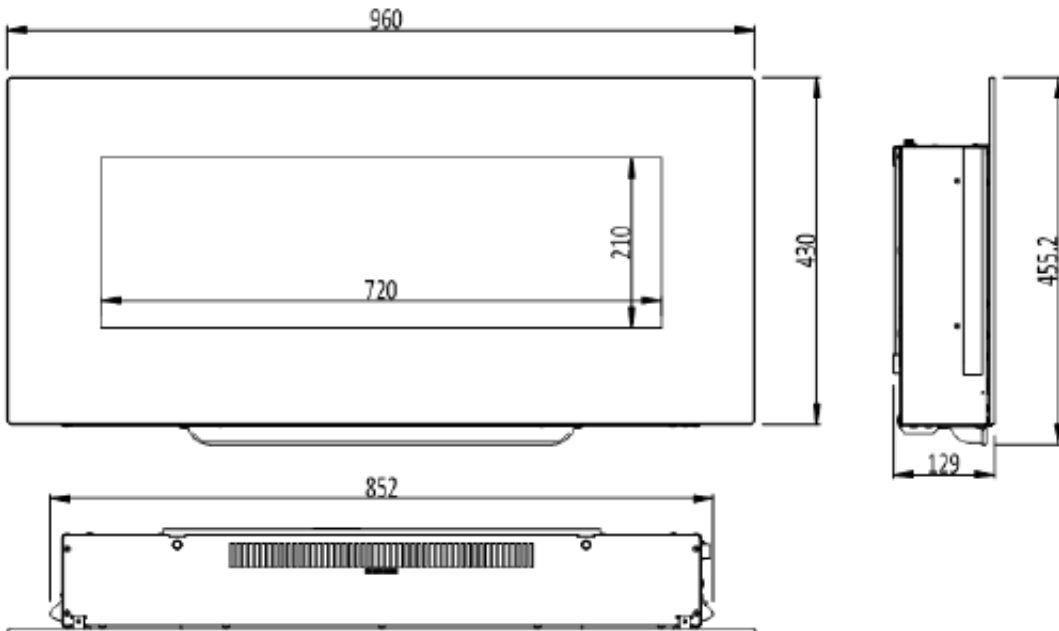

Before Installation

- Tools Required: A screw driver, power drill, suitable drill bits, safety gloves and goggles.
- **WARNING!** Do NOT use this appliance if any part has been under water. Immediately call a qualified service technician to inspect and to replace any part of the electrical system if necessary.
- Keep plastic wrapping away from children otherwise it may cause suffocation.
- Open the packaging carefully and remove the foam.
- Remove and discard the plastic bag.
- Be responsible when handling the packing materials.
- Keep the original packaging for future transport and/or storage.
- Check all accessories are present.

Installation: Free Standing Mode

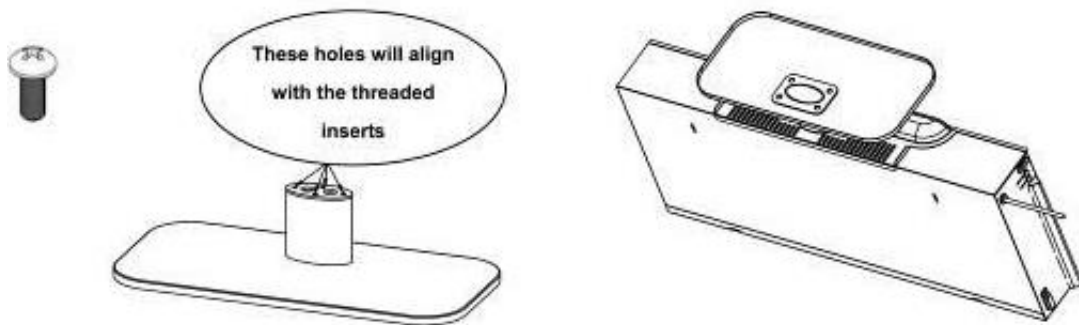

STEP 1. Lay the firebox on its back. Align the holes in the pedestal with the threaded inserts in the firebox. Thread four M5x16 machine screw through each hole in the pedestal and into the threaded inserts. Check the pedestal alignment.

2 x AAA

Installation: Free Standing Mode

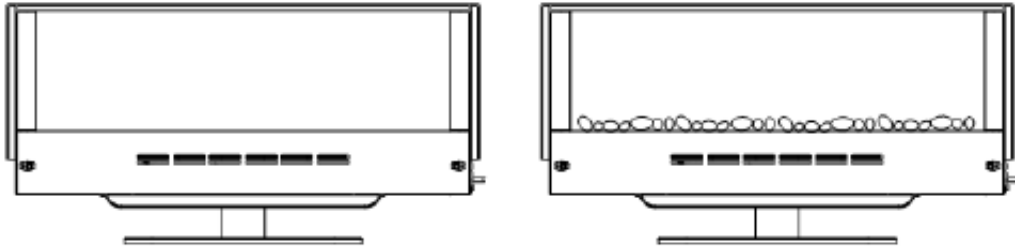

STEP 2. Stand the fireplace up and set it on a sturdy level surface at or near

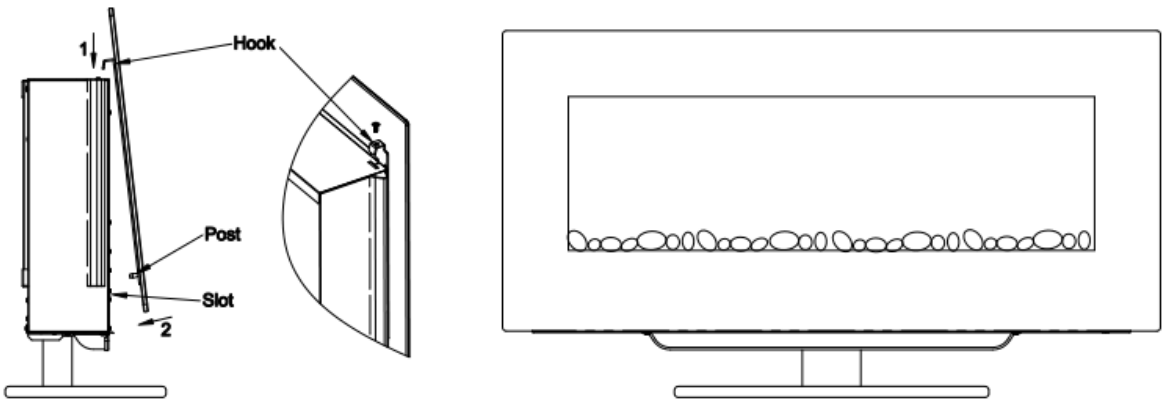

where you plan to use it. Carefully arrange the decorative stones along the inset window ledge at the front of the firebox. Use care when relocating the fireplace to prevent the decorative stones from falling out.

STEP 3. 1. Carefully set both hooks of the front glass panel into the slots at the top front edge of the firebox. 2. Press the two posts of the glass panel into the locking slots near the lower corners of the front firebox panel. **NOTE: Make sure the posts click into the slots.** This will keep the decorative glass in place. 3. Thread the ST4x8 screws (2) through the glass panel hooks and into the threaded holes in the firebox. Partially tighten by hand. Check the alignment of the glass panel and securely tighten the screws with a Phillips screwdriver.

Installation: Wall Hanging Mode

STEP 1 Find a safe location. Minimum clearance each side must be at least 100mm, minimum clearance from the floor must be at least 66mm minimum, clearance from the front must be at least 1 feet (900mm).

Choose a location near a outlet so an extension cord is not required. **DO** position the unit directly below a power outlet.

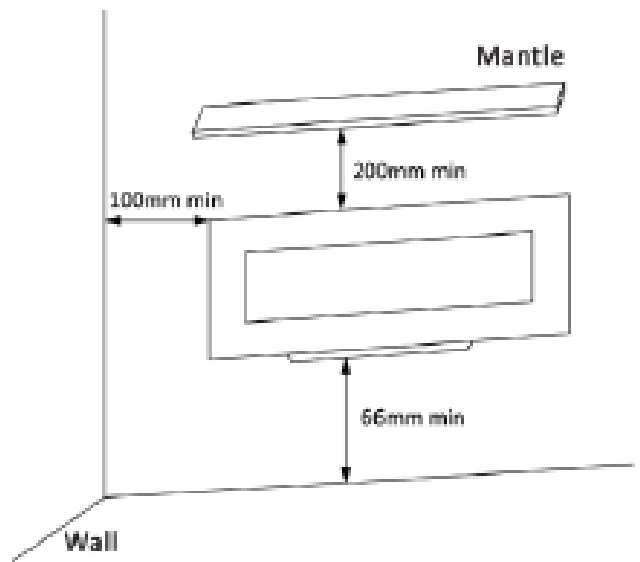

STEP 2. Choose a solid and plain wall and then put the bracket on the position where you want to install the fireplace. Mark the 4 holes with a pencil from the holes in the front of the bracket.

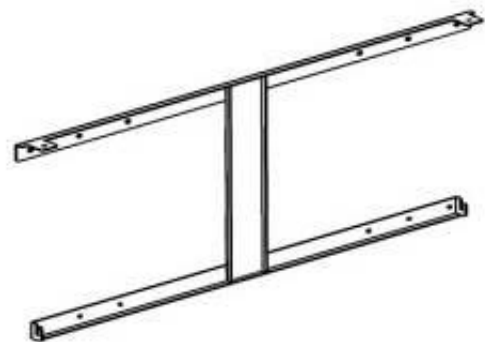

STEP 3. Take away the bracket and then drill 4 x $\Phi 8$ holes in the wall. Put the plastic wall plug into the hole. If the wall is solid wood there is no need to drill holes in the wood and no need to install the plastic wall plugs.

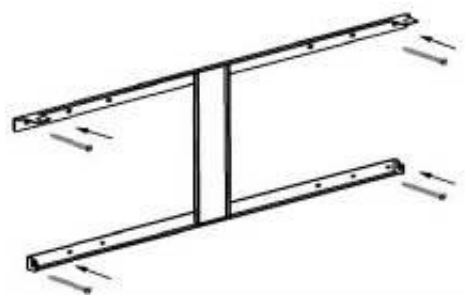

Installation: Wall Hanging Mode

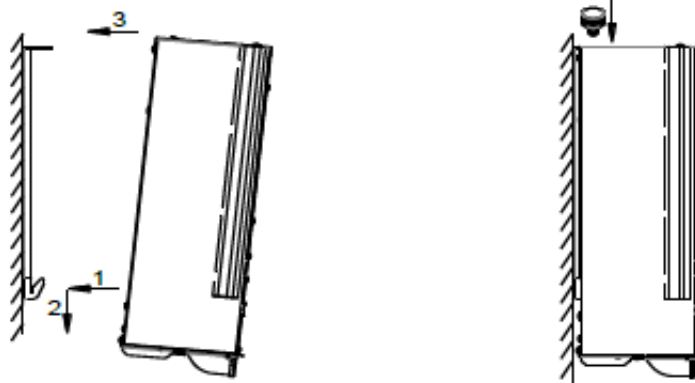

STEP 4. With the firebox at an angle, fit the slots in the back of firebox over the hooks on the wall mount bracket, and carefully press the top of the firebox against the wall mount bracket. The slots at the top edge of the firebox should slide over the wall mount bracket tabs. Hold the firebox in place and thread the thumb screws through the holes in the firebox and into the wall mount bracket tabs. Tighten both thumb screws and make sure the firebox is secure to the wall.

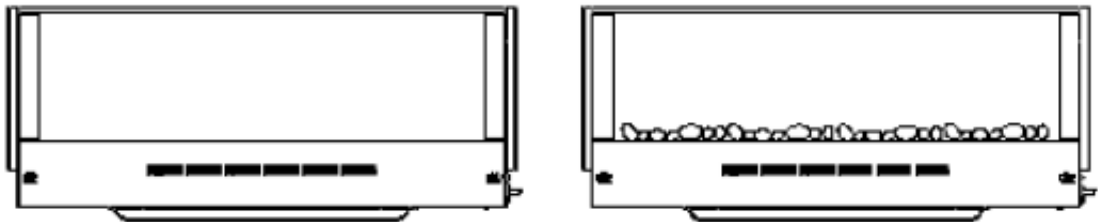

STEP 5. Carefully arrange the decorative stones (WS/CS) along the inset window ledge at the front of the firebox. Use care when relocating the fireplace to prevent the stones from falling out.

Installation: Wall Hanging Mode

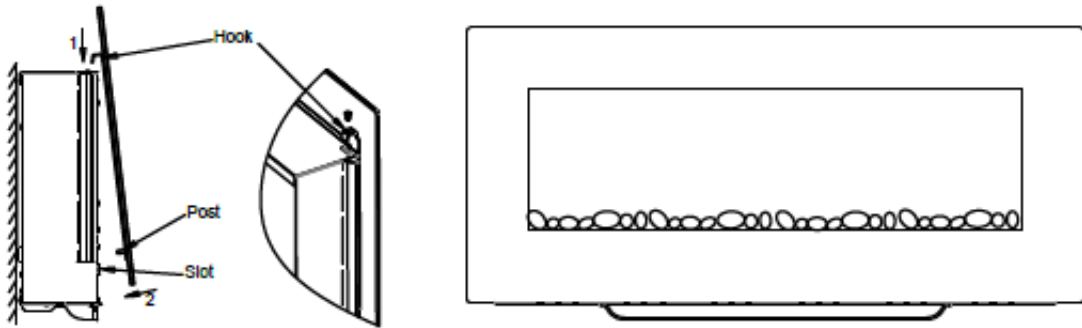

STEP 6. 1. Carefully set both hooks of the front glass panel into the slots at the top front edge of the firebox. 2. Press the two posts of the glass panel into the locking slots near the lower corners of the front firebox panel. **NOTE: Make sure the posts click into the slots.** This will keep the decorative glass in place.

3. Thread the ST4x8 screws (2) through the glass panel hooks and into the threaded holes in the firebox. Partially tighten by hand. Check the alignment of the glass panel and securely tighten the screws with a Phillips screwdriver.

Operation: Manual Control

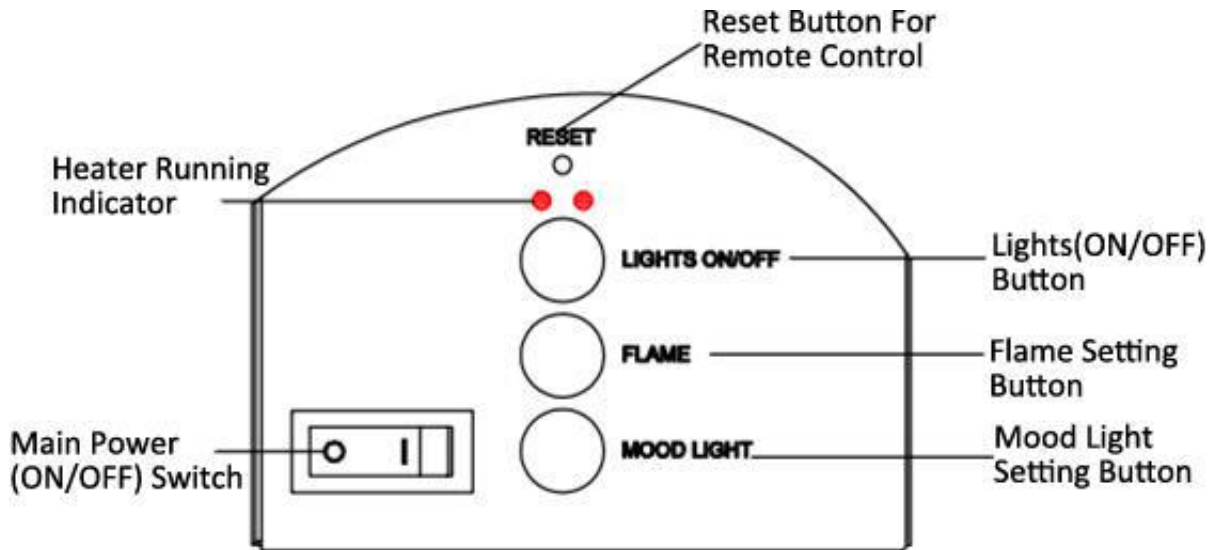

NOTE: The manual button controls basic functions, not a full range of controls. Use the remote handset to carry out all functions.

The manual buttons are located at the right side of the appliance.

Press "LIGHTS ON / OFF" to turn on or turn off both the flame and mood light at the same time.

Press "FLAME" button to select the colour of flame (3 kinds) or return to the OFF position.

Press "MOOD LIGHT" button to select the colour of the mood light (fourteen kinds) or return to the OFF position.

NOTE: The controls on the appliance will lose the memory for all function settings when the switch is set to the "Off" Position. When the remote runs out of power or when you change the batteries, only the flame function will lose memory and will not affect the timer settings, however, the clock may need adjusting.

Operation: Remote Control

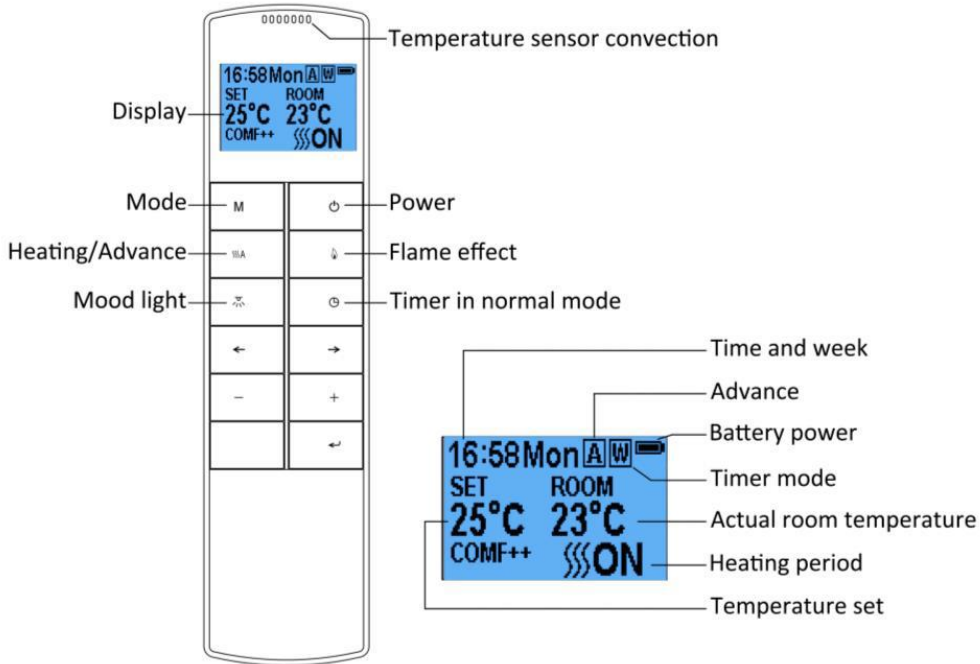

NOTE: This is a thermostatic remote control. The remote should be in the same room as fireplace and placed on a flat surface. It must be placed away from the fire so the hot air will not blow on it and affect thermostatic reading.

The communication frequency between the fire and remote has already been set up. If you cannot use the remote with the fire, please follow instructions Step.R34 to initiate this connection in point.

Standby for Remote Handset

R1 The screen shown to the right is when the remote handset is in standby mode.



Turn on / off

R2 Press  to turn on the flame effect, turn off flame effect and heater when in normal mode.

R3 Press  to turn on/off the flame effect under daily and weekly timer mode.

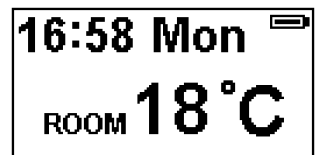

After Day / Time set up

Operation: Remote Control

Flame Effect

R4 Press  to enter the flame effect adjustment screen.

R5 Press the '←' and '→' button to select the 3 kinds of flame effect.

R6 Press the '+' and '-' button to select the 5 brightness levels of the flame effect and OFF settings

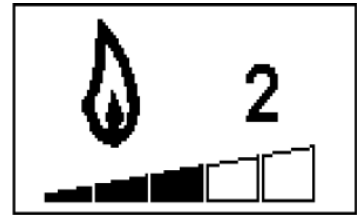

Mood Light

R7 Press  to enter the mood light adjustment screen.

R8 Press the '←' and '→' button to cycle through the 13 colours of mood light or a colour-cycle mode.



R9 Press the '+' and '-' button to select the 5 brightness levels of mood light and OFF settings



Normal Mode

R10 Normal control mode is factory set. If it is not, then press **M** button until the **N** logo shows up at the upper right corner of the screen.

R11 Press the '+' and '-' button to adjust the temperature setting from 17°C to 25°C by 2 °C intervals

R12 Press  **A** button to turn on/off heat,  ON,  OFF will show at the lower of the screen.

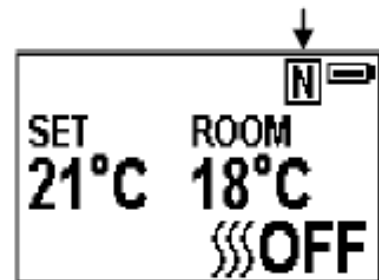

NOTE: It is normal for the fan heater to stop running for periods of time. This happens because the room temperature is at or above the temperature set on the remote control. The heater indicator will be turned off after 10s if you have the flame ON. The heater indicator will stay ON if you use the heating function only.

Operation: Remote Control

Count Down Timer

NOTE: This setting is only for normal mode. It allows the appliance to go into standby after a set period of time.

R13 Press to cycle through the settings from Off and 0.5 hours to 9 hours. The timer logo and time will show on the screen. **The heater must be in the ON position.**

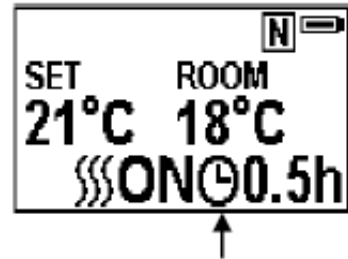

The heater can be automatically run by using daily timer and weekly timer on the remote.

Set up Day, Time and Comfortable temperature.

R14 Press to turn on the remote handset. Hold the button for 3 seconds to enter the setting screen.

R15 Press the '←' and '→' button to choose Day, Time or your comfortable temperature. The character selected will be highlighted.

R16 Pressing the '+' and '-' button will adjust the number.

- Time: 24-hour system
- Select your comfortable temperature from 15-25°C.
- Temperature unit: °C、°F

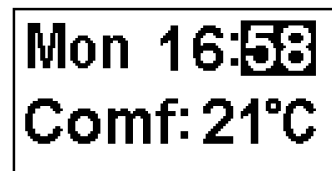

Daily Timer Heating

R17 The following are pre-set heating periods, which can be altered if desired

06:00 until 08:30

17:00 until 22:00

R18 Press **M** until **D** shows at the upper right corner of the screen then enter the daily timer heating mode.

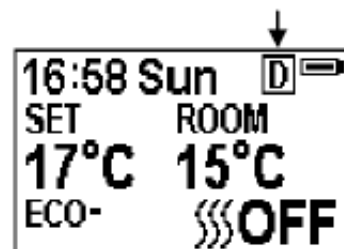

Operation: Remote Control

R19 Hold the arrow symbol button  for 6 seconds to enter the daily timer setting. Max 3 timed Heating periods per day.

- Press ‘←’ or ‘→’ to choose hour or minute, press ‘+’ or ‘-’ to set the time.
- Minute will increase / decrease by 15 minutes per press.
- Hold  for 3 seconds or wait for 10 seconds to save and exit the heating time period setting.

Day Timer Setting	
06:00 --	08:30
17:00 --	22:00
00:00 --	00:00

R20 Adjusting the set temperature

- Press the ‘+’ or ‘-’ button to increase or decrease set temperature on the basis of your comfortable temperature setting.
- ECO means 2°C lower than your comfortable temperature setting,

ECO- means 4°C lower,
COMF+ means 2°C higher,
COMF++ means 4°C higher.

R21 To check your daily timer settings press

R22 If heating needs to be turned off, it will be necessary to go back to the Normal Mode to turn off.

Week Timer Heating

R23 The following are pre-set heating periods, which can be altered if desired.

From Monday to Friday

06:00 until 08:30

17:00 until 22:00

From Saturday to Sunday

06:30 until 09:30

11:00 until 13:00



17:00 until 22:00



R24 Press **M** until  shows at the upper right corner of the screen, then enter the week timer heating mode.

Operation: Remote Control

R25 Hold  button for 6 seconds to enter the week timer setting

- Press '←' or '→' to move the cursor (a flashing underline), press the  button in the corresponding week position to select (the character is highlighted) or cancel (the character is displayed normally) the current setting. Several days can be selected together.
- Press the '→' button to move the cursor to the time period setting area. Press '←' or '→' to choose hour or minute, press '+' or '-' to set the number.
- Max 3 heating periods for a day.
- Minute will increase/decrease by 15 minutes per press.
- Press the  to set the heating time for the selected day(s) and return to the week line.
- Hold  for 3s or wait for 10s to save and exit the heating time period setting.

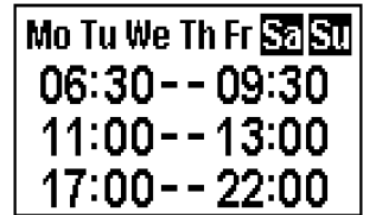
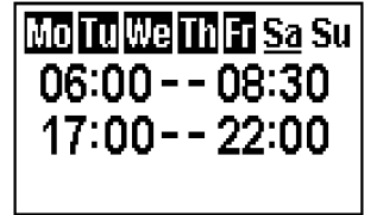

R26 Press , '←' and '→' to check your week Timer settings.

R27 If heating needs to be turned off, it will be necessary to go back to the Normal Control Mode to turn off.

Advance Mode

R28 Under the daily and week timer mode, Press  **A**

R29 To turn the heater off when the heater is on during a pre-set heating period

R30 To turn the heater on when the heater is off in between pre-set heating periods



Adaptive Start Control

R31 According to room temperature and set temperature, the heater will automatically come on in time to heat the room to the set temperature at the set time. For example, if your timer is set to start at 18:00 and temperature is set to 23°C, the fire will come on at 17:30 to ensure the room is 23°C at 18:00.

Operation: Remote Control

Window Open Detection

R32 When the transmitter detects a rapid drop in room temperature, it will be judged as a window open, the warning icon will be displayed and the heating will be turned off automatically.

R33 After the indoor temperature has risen or a manual override of the warning (by operating remote control) has been done, the fire will return to normal working state.



Set up the communication between the remote and appliance

R34 The below operations should be carried out before programming, when changing to a new remote or in the event the appliance cannot be controlled by the remote:

- Hold the reset button on the appliance for 3 seconds (pen Point may needed) until you hear 3 short beeps from the unit, release the button.
- Press the button on the remote, the programming is finished when you hear 1 long beep from the appliance.





R35 Resetting the code for remote control is necessary if the appliance operates wrongly or the remote control does not operate correctly.

- Open the back cover of the remote control.
- Press the Reset button on remote handset.
- Follow the steps R34

Remote Control Battery Replacement

When the batteries are at full power, the battery symbol will show 

When the batteries are half full, the battery symbol will show 

When the batteries are out of power and need replacing immediately, the battery symbol will show 

Battery replacement is recommended after 1 year. The batteries are 1.5V alkaline AAA, batteries.

Dispose of old batteries at an appropriate recycling facility.

Safety thermal cut-out

This appliance is fitted with an Electric Safety Control (E.S.). This is a safety device, which switches off the fire if, for any reason, the appliance overheats. The E.S. Control can only be re-set after the appliance has cooled down, in Order to re-set the E.S. Control, proceed as follows: Switch off the appliance. Unplug at wall socket and leave for approximately 5-10 minutes. Plug in switch on appliance and the E.S. Control will re-set.

Ensure that the appliance is functioning correctly. If the E.S. Control switches off again it is advisable to have the appliance checked by a competent electrician.

Note: -This appliance also has a secondary thermal fuse link incorporated into the heating element that will break the electrical circuit in the event that the heater fan fails to operate. Unlike the E.S. if this link breaks the fire will not be allowed to re set and the appliance should be checked by a competent electrician and the fan/element replaced.

CAUTION: In order to avoid a hazard due to inadvertent resetting of the thermal cut out, this appliance must not be supplied through an external switching device, such as a timer, or connected to a circuit that is regularly switched on and off by the utility.

Control PCB	Remote Control Receiver	Remote Control Transmitter
Hardware: RC01-040A01 Software: 20171024	Hardware: RF290B V1.2	Frequency: ASK/OOK 433.92MHZ Maximum transmit power: 10mW Hardware:RF290A-TX-V1.3 Software: RF290A_C_V0.6.0.hex

Maintenance

Cleaning the Fireplace

Cleaning or polishing products are not recommended. Fingerprints or other marks on the front glass panel can be removed by a piece of soft, damp, lint-free cloth with a good quality household glass cleaner. The front glass panel should always be completely dried with a clean, lint-free cloth or paper towel.

CAUTION: Abrasive cleaners should not be used on the glass panel. Liquids should not be sprayed directly onto any surface of the unit.

The heater fan may need clearing of dust and pet hair etc. after a period, depending upon the amount of usage, this may be done using a vacuum cleaner but the appliance must be disconnected from the power before you start.

In the unlikely event that the appliance is damaged or incomplete, return the appliance in the original packaging to the place where it was purchased.

The appliance is supported with a “back to base warranty” so please retain the original packaging.

In unlikely event of the appliance malfunctioning during the 12-month warranty period please ring our technical help desk first.

We recommend that appliances returned under warranty are sent registered post.

Please ensure it is well packed we cannot be responsible for transit damage.

NOTE: Your statutory rights are not affected.

Electric Fire Guarantee

Be Modern Ltd. (the 'Company') provides a **twelve month** guarantee in respect of electric fire (the 'Product') ranges.

1. The twelve month Guarantee applies to:

- a. All products in the ranges manufactured by the 'Company' (but subject to the exceptions below): where:
- b. The product has been purchased and installed within the UK and in respect of
- c. The initial installation: and in favor of
- d. The original purchaser

2. Proof of Purchase must be retained by the Purchaser

3. The twelve month Guarantee does not apply to:

- a. Damage or inferior workmanship practices whilst the 'Product' is being installed
- b. Damage caused by mis-use of the 'Product' or where normal standards of care and use have not been complied with.
- c. Damage through a malfunction or an inadequately installed electric fire.
- d. Damage or defects due to mis-use, accident or unauthorised alterations.

4. During the twelve month after the "Product" has been supplied, the Guarantee covers the making good (whether by repair or replacement at the Company's option) of defects arising from defective manufacture of materials of "Product" covered in Para 1 all at no cost to the purchaser on the provision:

- a. The Product has been installed as per Be Modern recommendations. The Purchaser uninstalls the Product and makes it available for collection by Be Modern.

This Guarantee does not affect your statutory rights

On requiring service the purchaser should contact the retailer who supplied your product who will assist and advise you as necessary.

Be Modern Ltd.
19/34 Bedesway
Bede Industrial Estate
Jarrow
Tyne and Wear
NE32 3BE
Tel: (0191) 430 0901
Fax: (0191) 430 9522
<http://www.bemodern.com>

General Information

Environment



Meaning of crossed –out wheeled dustbin:

Electrical appliances should not be disposed as unsorted municipal waste. Separate collection facilities should be used in the disposal of electrical appliances. Contact your local government for the information about the available collection systems. If electrical appliances are disposed of in landfills or dumps, hazardous substances can leak into the groundwater and get into the food chain, damaging your health and well-being. When old appliances are replaced by the new ones, it is a legal obligation for the retailer to take back the old appliance for disposals at least free of charge.



This fire complies with the Safety Standards EN 60335-1 and EN 60335-2-30 which covers the essential requirements of the Low Voltage Directive 2014/35/EU and the EMC standards EN 55014-1; EN 55014-2; EN 61000-3-2 and EN 61000-3-3 which covers the essential requirements of the European Electro Magnetic Compatibility 2014/30/EU, and the RED standards EN300220-2, EN301489-1, EN301489-3 and EN6247 which covers the essential requirements of the European Radio Equipment Directive 2014/53/EU.



This fire complies with the Safety Standards BS 60335-1 and BS 60335-2-30 which covers the essential requirements of the Electrical Equipment (Safety) Regulations 2016 and the EMC standards BS 55014-1; BS 55014-2; BS 61000-3-2 and BS 61000-3-3 which covers the essential requirements of the Electro Magnetic Compatibility Regulations 2016, and the RED standards BS 300220-2, BS 301489-1, BS 301489-3 and BS 6247 which covers the essential requirements of the Radio Equipment Regulations 2017.



RoHS stands for Restriction of Hazardous Substances, and impacts the entire electronics industry and many electrical products as well. The Restrictions of the Use of Certain Hazardous Substances in Electrical and Electronic Equipment Regulations 2012, originated in the European Union in 2002 and restricts the use of six hazardous materials found in electrical and electronic products. All applicable products in the EU and UK market since July 1, 2006 must pass RoHS compliance.