

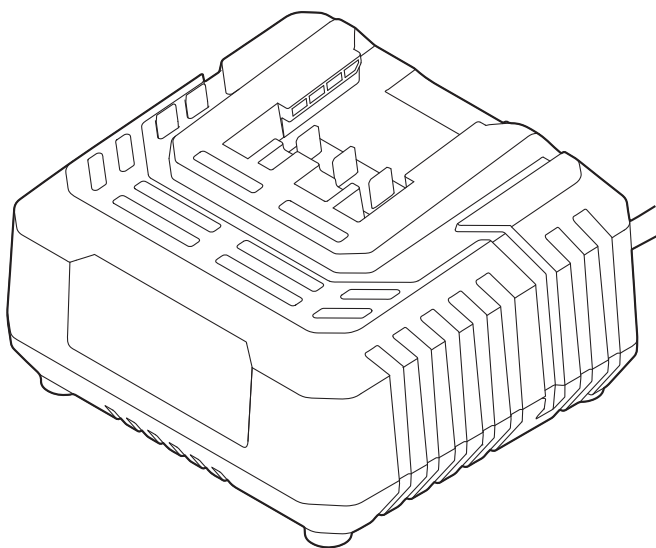

**Erbauer**



# EC18-Li

ORIGINAL INSTRUCTIONS



Safety instructions



Product description



Assembly



Use



+



Care & maintenance



Guarantee



Declaration of Conformity



**WARNING!** Please read all safety warnings carefully and be sure that they are fully understood before handling the tool.

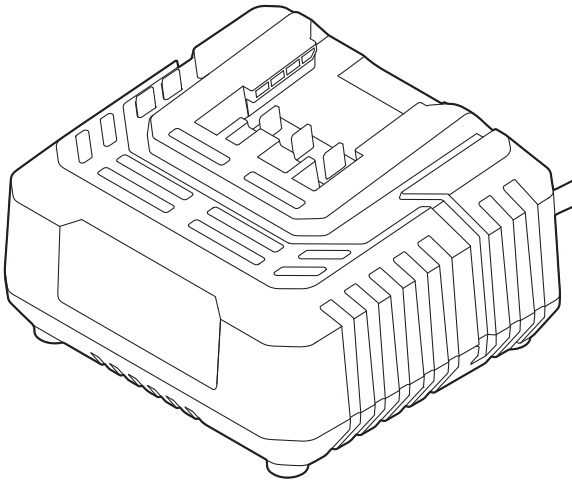



# PRODUCT DESCRIPTION

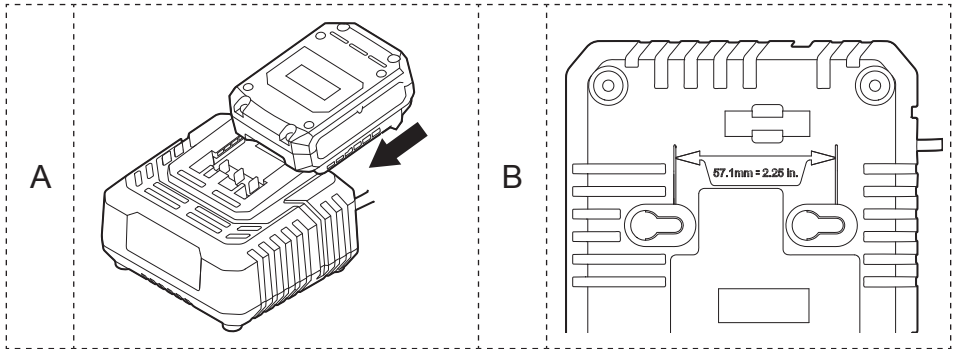
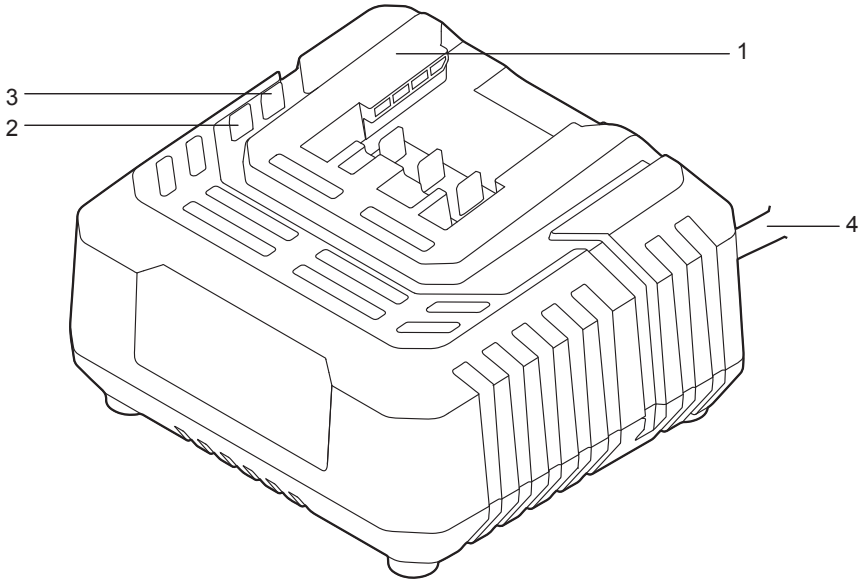



## SAFETY INSTRUCTIONS



**WARNING!** Read all safety warnings and all instructions. Failure to follow the warnings and instructions may result in electric shock, fire and/or serious injury.

**Save all warnings and instructions for future reference.**

- a. *This appliance can be used by children aged from 8 years and above and persons with reduced physical, sensory or mental capabilities or lack of experience and knowledge if they have been given supervision or instruction concerning use of the appliance in a safe way and understand the hazards involved. Children shall not play with the appliance. Cleaning and user maintenance shall not be made by children without supervision.*
- b. *If the supply cord is damaged, it must be replaced by the manufacturer, its service agent or similarly qualified persons in order to avoid a hazard.*
- c. *Charger is for indoor use only.*
- d. *When the charger is in use it **MUST** be supervised, if there is any evidence of overheating then **IMMEDIATELY** disconnect the charger from the power supply.*
- e. *If gas or smoke is emitted from the battery during charging switch off the power supply and move to a well vented area.*
- f. *Always disconnect battery charger and remove battery from charger when the charging is complete.*
- g. *Only charge the battery pack specifically stated on this instruction manual.*
- h. *Do not charge a damaged battery pack.*

- i. Do not charge non-rechargeable batteries.*
- j. Always charge the battery pack between temperatures 5°C to 40°C. Ideal charging temperature is 18°C to 24°C.*

### **IMPORTANT NOTE**

*Be sure the supply is the same as the voltage given on the rating plate for the charger. The charger is fitted with a two-core cable and plug. Remove the mains plug from socket before carrying out any adjustment or servicing.*



## PRODUCT DESCRIPTION

1. Charger
2. Red LED light
3. Green LED light
4. Cable & plug

## 01 TECHNICAL SPECIFICATIONS

Rated input 220-240 V ~ 50Hz 60W

Rated output 21 V d.c. 2.4A

Protection class II / 

Weight: approx. 0.5 kg

### For charging: 18V Li-Ion battery packs as below

Battery pack model:	EBAT18-Li-2	EBAT18-Li-4	EBAT18-Li-5	EHPB18-Li-4	EHPB18-Li-8
---------------------	-------------	-------------	-------------	-------------	-------------

Rated capacity:	2Ah	4Ah	5Ah	4Ah	8Ah
-----------------	-----	-----	-----	-----	-----

Battery cells:	3.6V x 5pcs	3.6V x 10pcs	3.6V x 10pcs	3.6V x 5pcs	3.6V x 10pcs
----------------	-------------	--------------	--------------	-------------	--------------

Charging time(Approx.)	60min	120min	150min	110min	205min
------------------------	-------	--------	--------	--------	--------

### RATING LABEL EXPLANATION

**EC18-Li = MODEL NUMBER**

**E = ERBAUER**

**C = Charger**

**18 = 18V**

**Li = LITHIUM  
ION**



## ASSEMBLY

### 01 SYMBOLS



Warning



Class II equipment



For indoor use only



Read the operator's manual



Time lag fuse with rated current of 2.0A



Positive terminal



Negative terminal

yyWxx Manufacturing date code: Year of manufacturing (20yy) and week of manufacturing (Wxx)



## 02 UNPACKING

Unpack all parts and lay them on a flat, stable surface.

- Remove all packing materials and shipping devices, if applicable.
- Make sure the delivery contents are complete and free of any damage. If you find that parts are missing or show damage do not use the product but contact your dealer. Using an incomplete or damaged product represents a hazard to people and property.
- Ensure that you have all the accessories and tools needed for assembly and operation. This also includes suitable personal protective equipment.



**WARNING!** The product and the packaging are not children's toys!  
Children must not play with plastic bags, sheets and small parts! There is a danger of choking and suffocation!



USE

## 01 INTENDED USE













This charger is solely for the charging of batteries listed in the TECHNICAL SPECIFICATION section.

### CHARGING YOUR BATTERY PACK (A)



**WARNING!** The charger and battery pack are specifically designed to work together so do not attempt to use any other devices. Never insert or allow metallic objects into your charger or battery pack connections because an electrical failure and hazard will occur.

1. Slide the battery pack onto the charger.
2. Connect the charger to a suitable power supply.
3. The LED lights on charger show different status as below.

RED LED	GREEN LED	STATUS	REMARK
On 	Off 	HOT/COLD Battery 	The charger will recover to charge when the temperature drops to 40°C or raises to 5°C
Flashing 	Off 	Defective 	Battery pack or charger is defective
Off 	Flashing 	Charging 	
Off 	On 	fully charged 	Disconnect charger from power supply and remove battery pack from charger

### WALL-MOUNT HOLES (B)

The charger has hanging holes for convenient storage. Install screws in the wall 2.25 inches (57.1mm) apart. Use screws sufficiently strong to hold the combined weight of the charger and battery pack .



## CARE & MAINTENANCE



**WARNING!** Remove the plug from the socket before carrying out any adjustment, servicing or maintenance.

Your battery charger requires no additional lubrication or maintenance. Never use water or chemical cleaners to clean your charger. Wipe clean with a dry cloth.

Always store your charger in a dry place.

### ENVIRONMENTAL PROTECTION



Waste electrical products should not be disposed of with household waste.

Please recycle where facilities exist. Check with your Local Authority or retailer for recycling advice. For further information visit [www.recycle-more.co.uk](http://www.recycle-more.co.uk).

### PLUG REPLACEMENT

If you need to replace the fitted plug, then follow the instructions below.

**IMPORTANT:** The wires in the mains lead are coloured in accordance with the following code:

#### BLUE – NEUTRAL BROWN – LIVE

As the colours of the wire in the mains lead of this product may not correspond with the coloured marking identifying the terminals in your plug, proceed as follows. The wire, which is coloured blue, must be connected to the terminal, which is marked with N or coloured black. The wire, which is coloured brown, must be connected to the terminal, which is marked L or coloured red.

5 AMP fuse approved to BS 1362

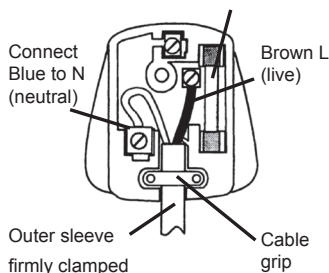



**WARNING!** Never connect live or neutral wires to the earth terminal of the plug, which is marked with E.

Only fit an approved 13 Amp BS1363 or BS1363/A plug and the correctly rated fuse. If in doubt, consult a qualified electrician.



**NOTE:** If a moulded plug is fitted and must be removed take great care in disposing of the plug and severed cable, it must be destroyed to prevent engaging into a socket.



## GUARANTEE

At **Erbauer** we take special care to select high quality materials and use manufacturing techniques that allow us to create ranges of products incorporating design and durability. That's why we offer a 2 year trade guarantee against manufacturing defects on our **Erbauer** power tool products.

This power tool is guaranteed for 2 years from the date of purchase, if bought in store, delivered or bought online. You may only make a claim under this guarantee upon presentation of your sales receipt or purchase invoice. Please keep your proof of purchase in a safe place.

This guarantee covers product failures and malfunctions provided the **Erbauer** power tool was used for the purpose for which it is intended and subject to installation, cleaning, care and maintenance in accordance with standard practice and with the information contained above and in the user manual. This guarantee does not cover defects and damage caused by or resulting from:

- Normal wear and tear, including accessory wear
- Overload, misuse or neglect
- Repairs attempted by anyone other than an authorised agent
- Cosmetic damage
- Damage caused by foreign objects, substances or accidents
- Accidental damage or modification
- Failure to follow manufacturer's guidelines
- Loss of use of the goods

This guarantee is limited to parts recognised as defective. It does not, in any case, cover ancillary costs (movement, labour) and direct and indirect damage.

If the **Erbauer** power tool is defective during the guarantee period, then we reserve the right, at our discretion, to replace the item with a product of equivalent quality and functionality or to provide a refund.

This guarantee only applies to the country of purchase or delivery and is not transferrable to any other countries. This guarantee is non-transferrable to any other person or product. Relevant local law will apply to this guarantee.

Guarantee related queries should be addressed to a store affiliated with the distributor you purchased the **Erbauer** power tool from.

This guarantee is in addition to and does not affect your statutory rights relating to faulty goods as a consumer.



## DECLARATION OF CONFORMITY



### EU Declaration of Conformity

**We**  
**Kingfisher International Products B.V.**  
**Rapenburgerstraat 175E**  
**1011 VM Amsterdam**  
**The Netherlands**

Declare that the product:  
Erbauer 18V charger EC18-Li  
Serial number 00001-99999

Complies with the essential health and safety requirements of the following directives:

2014/35/EU Low Voltage Directive  
References to the following harmonized standard were made:  
EN 60335-1:2012+A11:2014+A13:2017  
EN 60335-2-29: 2004+A2:2010  
EN 62233:2008

2014/30/EU Electromagnetic Compatibility directive  
References to the following harmonized standard were made:  
EN55014-1: 2017  
EN55014-2: 2015  
EN61000-3-2: 2014  
EN61000-3-3: 2013

(EU) 2015/863 Restrictions of the Use of Certain Hazardous Substances in  
Electrical and Electronic Equipment

Authorised signatory and technical file holder:

Kingfisher International Products B.V.  
Rapenburgerstraat 175E  
1011 VM Amsterdam  
The Netherlands

on: 18/09/2019

Eric Capotummino  
Group Quality Director



**Manufacturer • Fabricant • Producent • Producător • Fabricante:**

**UK manufacturer:**

Kingfisher International Products Limited  
3 Sheldon Square London W2 6PX  
United Kingdom  
[www.kingfisher.com/products](http://www.kingfisher.com/products)

**EU manufacturer:**

Kingfisher International Products B.V.  
Rapenburgerstraat 175E  
1011 VM Amsterdam  
The Netherlands

[www.diy.com](http://www.diy.com) | [www.screwfix.com](http://www.screwfix.com) | [www.screwfix.ie](http://www.screwfix.ie)

To view instruction manuals online,  
visit [www.kingfisher.com/products](http://www.kingfisher.com/products)

Customer Helpline (Freephone)

UK 0800 324 7818 [uk@kingfisherservice.com](mailto:uk@kingfisherservice.com)

Eire 1800 932 230 [eire@kingfisherservice.com](mailto:eire@kingfisherservice.com)





**Erbauer**

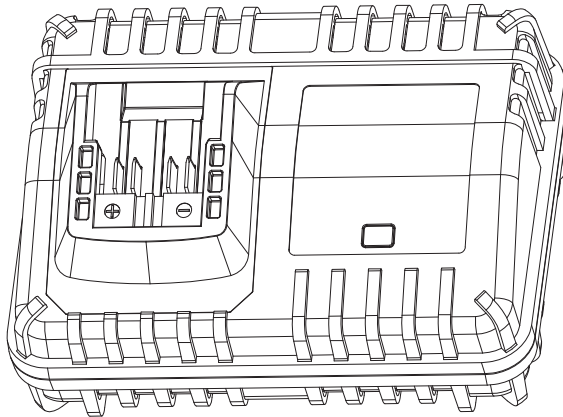

Original Instructions - MNL\_EBC12-Li / EBFC12-Li\_GB\_V1\_210719

# EBC12-Li

# EBFC12-Li

EAN: -/5059340010809

**ORIGINAL INSTRUCTIONS**







EN



V80421 BX220IM



EN

	Safety instructions	5
	Product description	7
	Assembly	8
	Use	10
	Care & maintenance	12
	Guarantee	15
	Declaration of conformity	16



**WARNING!** Please read all safety warnings carefully and be sure that they are fully understood before handling the tool.

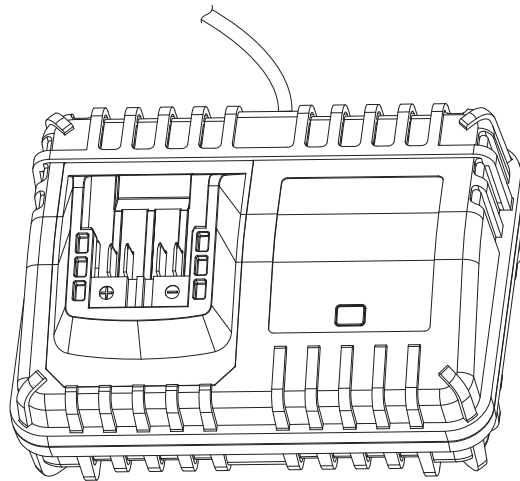



EN



## Product description

1

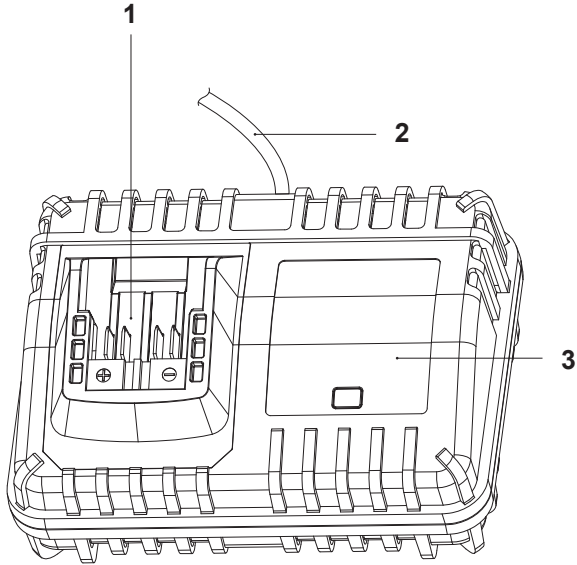

A

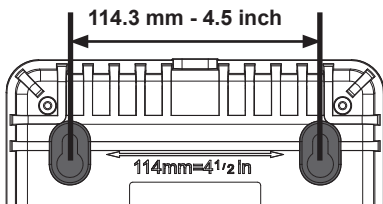

B

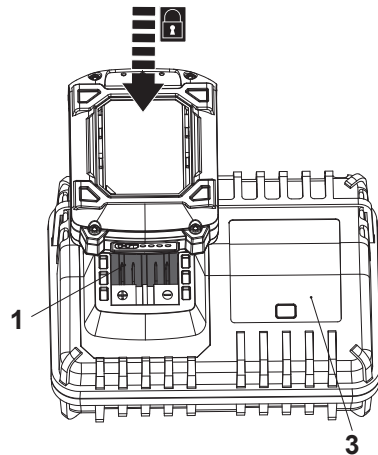



## Safety instructions

# GENERAL SAFETY WARNINGS FOR BATTERY CHARGER



**WARNING! Read all safety warnings, instructions, illustrations and specifications.** Failure to follow all instructions listed below may result in electric shock, fire and/or serious injury.

**Save all warnings and instructions for future reference.**

- a) This appliance can be used by children aged from 8 years and above and persons with reduced physical, sensory or mental capabilities or lack of experience and knowledge if they have been given supervision or instruction concerning use of the appliance in a safe way and understand the hazards involved. Children shall not play with the appliance. Cleaning and user maintenance shall not be made by children without supervision.
- b) Only charge the battery pack specifically stated on this instruction manual.
- c) Do not charge non-rechargeable batteries.
- d) If the supply cord is damaged, it must be replaced by the manufacturer, its service agent or similarly qualified persons in order to avoid a hazard.
- e) Disconnect the charger from the power supply and allow it to cool down before cleaning, maintenance, storage and transportation.



EN

- f) Protect the electrical parts against moisture. Do not immerse such parts in water or other liquids to avoid electrical shock. Never hold the charger under running water. Read the instructions provided in the chapter “Care and maintenance”.
- g) Before using the charger, read all the instructions and cautionary markings on the charger and battery pack.
- h) Charge the battery pack indoors only as the charger is designed for indoor use only.
- i) Do not place any object on top of the charger as it could cause overheating. Do not place the charger near any heat source.
- j) Do not use the charger if it has been subjected to a heavy knock, dropped or otherwise damaged in any way. Have the charger checked and repaired by an authorised service centre.
- k) Do not disassemble the charger. Incorrect re-assembly may result in the risk of fire, electric shock or electrocution.
- l) To reduce the risk of damage to the power cord and plug, always pull the plug rather than the power cord when disconnecting the charger from power supply.

## EMERGENCY

**Familiarise yourself with the use of this product by means of this instruction manual. Memorise the safety directions and follow them to the letter. This will help to prevent risks and hazards.**

- a) **Always be alert when using this product, so that you can recognise and handle risks early.** Fast intervention can prevent serious injury and damage to property.
- b) **Disconnect from the power supply if there are malfunctions.** Have the product checked by a qualified professional and repaired, if necessary, before you operate it again.



Product description

## Part index

The index below refers to Fig. 1 on page 4.

1. Sliding slot
2. Power cord with plug
3. Charger status indicator

## Technical data

Charger model	EBFC12-Li	EBC12-Li
> Rated input	: 100-240 V~, 50/60 Hz, 90 W	100-240 V~, 50/60 Hz, 60 W
> Rated output	: 12 V d.c., 6 A	12 V d.c., 4 A
> Protection class	: II	
> Weight	: approx. 0.6 kg	

### For charging 12V Li-Ion battery packs as below:

> Battery pack model	: EHPB12-Li-6	EHPB12-Li-3
> Battery capacity	: 6.0 Ah	3.0 Ah
> Battery cells	: 3.6 V x 6 pcs	3.6 V x 3 pcs
> Approx. Charging time (EBFC12-Li / EBC12-Li)	: 80min/120min	45min/60min
> Ambient temperature range	: 0 - 45 °C	

## Rating label explanation

EBC12-Li and EBFC12-Li = Model number

E = Erbauer

BC = Battery Charger

BFC = Battery Fast Charger

12 = For 12V battery

Li = Li-Ion



EN



Assembly

## 01 Symbols

On the product, the rating label and within these instructions you will find among others the following symbols and abbreviations. Familiarise yourself with them to reduce hazards like personal injuries and damage to property.

V ~ Volt, (alternating voltage)  
 Hz Hertz  
 A Ampere  
 W Watt

mm Millimetre  
 kg Kilogram  
 °C Degree Celsius

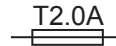
 Time lag fuse of rating 2.0 A



Lock / to tighten or secure.



Unlock / to loosen.



Read the instruction manual.



Note / Remark.



Caution / Warning.

xxWyy

Manufacturing date code; year of manufacturing (20xx) and week of manufacturing (Wyy)



This charger is of protection class II. That means it is equipped with enhanced or double insulation



Open flames in the work area, around the product and in the vicinity of flammable materials are prohibited!



Do not smoke in the work area, around the product and in the vicinity of flammable materials!



WEEE symbol. Waste electrical products should not be disposed of with household waste. Please recycle where facilities exist. Check with your Local Authority or local store for recycling advice.



Only use the battery charger indoors.



The product complies with the applicable European directives and an evaluation method of conformity for these directives was done.



UK Conformity Assessed.



## 02 Unpacking

1. Unpack all parts and lay them on a flat, stable surface.
2. Remove all packing materials and shipping devices, if applicable.
3. Make sure the delivery contents are complete and free of any damage. If you find that parts are missing or show damage, do not use the product but contact your dealer. Using an incomplete or damaged product represents a hazard to people and property.
4. Ensure all the accessories and tools needed for assembly and operation are at your disposal, including suitable personal protective equipment.



**WARNING!** The product and the packaging are not children's toys! Keep plastics bags, sheets and small parts away from children. There is a danger of choking and suffocation!

## 03 Setup

### WALL-MOUNT HOLES

The charger has hanging holes for convenient storage.

Install screws in the wall 4.5 inches (114.3 mm) apart (Fig. A). Use screws sufficiently strong to hold the combined weight of the charger and battery pack.

### Connection to power supply

1. Connect the power cord plug (2) with a suitable socket.



**WARNING!** Check the voltage! The voltage must comply with the information on the rating label!

2. Your product is now ready to be used.



EN



Use

## Intended use

This charger is solely for the charging of batteries listed in the “Technical Specifications” section.

For safety reasons it is essential to read the entire instruction manual before first operation and to observe all the instructions therein.

## Charging the battery pack



**WARNING!** Do not use any charger other than that specifically provided for use with the equipment.

Always charge in a safe location away from moisture or heat sources!

1. Align and slide the battery pack onto the sliding slots (1) of the charger all the way to the stop (Fig. B).
2. Connect the charger plug (2) to the power supply.
3. The charging status indicator (3) flashed in green.
4. The charging status indicator (3) turns green after charging is done (see below "Power / charging status indicator" section for charging status), disconnect the charger plug (2) from power supply.
5. Remove the battery pack from the charger.



**NOTE:** It is normal for the battery pack and charger to become warm (but not hot) during the charging process. Depending on temperature and existing charge level, the actual charging time may change.

The battery in your new tool is not charged when it leaves the plant. Therefore, it must be fully charged before using the first time.



**WARNING!** Always charge the battery before storage! Please charge the battery to reach full or no less than half charge before storage. If the tool will not be used for long periods of time, charge the battery every 3-6 months.

It is important to disconnect the charger from the power supply after charging finished.

Cool down battery pack from a just-operated product for approximately 15 minutes before attempting to recharge!

### Power / Charging status indicator

The charging status indicator (3) on the charger show the status as described in below table.

Charging status indicator (3)		Status	Remark
Red light		Hot/Cold battery	The charger will recover to charge when the temperature back to normal range.
Flashing red light		Defective	Battery pack or charger is defective.
Flashing green light		Charging	Battery is charging normally.
Green light		Fully charged	Disconnect charger from power supply and remove battery pack from charger.

## After use

1. Disconnect charger from power supply and remove battery pack from charger and let it cool down.
2. Check, clean and store the product as described below.



## Care & maintenance



### WARNING!

Always switch the product off, disconnect the product from the power supply and let the product cool down before performing inspection, maintenance and cleaning work!



Only perform care and maintenance work according to these instructions! All further works must be performed by a qualified specialist!

## Clean

1. Clean the product with a dry cloth. Use a brush for areas that are hard to reach.
2. In particular clean the air vents after every use with a cloth and brush.
3. Remove stubborn dust with high pressure air (max. 3 bar).
4. Check for worn or damaged parts. Replace worn parts as necessary or contact an authorised service centre for repair before using the product again.



**NOTE:** Do not use chemical, alkaline, abrasive or other aggressive detergents or disinfectants to clean this product as they might be harmful to its surfaces.

## Maintenance

Before and after each use, check the product and accessories (or attachments) for wear and damage. If required, exchange them for new ones as described in this instruction manual. Observe the technical requirements.

### 01 Power cord

If the supply cord is damaged, it must be replaced by the manufacturer, its service agent or similarly qualified persons in order to avoid a hazard.

**WARNING!**

Do not use the product with a defective or a loose power cord!

**UK plug (only for UK market)**

If you need to replace the fitted plug, then follow the instructions below.

**IMPORTANT:** The wires in the mains lead are coloured in accordance with the following code:

Blue – Neutral

Brown – Live

As the colours of the wire in the mains lead of this product may not correspond with the coloured marking identifying the terminals in your plug, proceed as follows. The wire, which is coloured blue, must be connected to the terminal, which is marked with N or coloured black. The wire, which is coloured brown, must be connected to the terminal, which is marked L or coloured red.

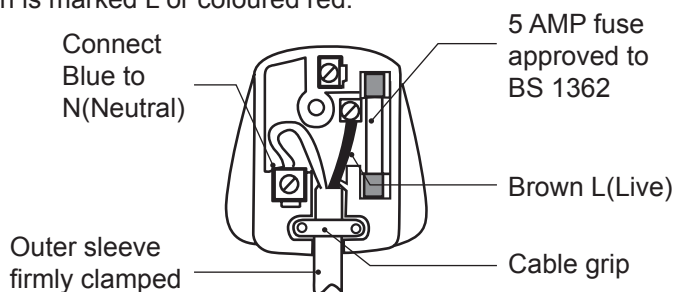

**WARNING!** Never connect live or neutral wires to the earth terminal of the plug, which is marked with E.

Only fit an approved 13 Amp BS 1363 or BS 1363/A plug and the correctly rated fuse. If in doubt, consult a qualified electrician. If a moulded plug is fitted and has to be removed take great care in disposing of the plug and severed cable, it must be destroyed to prevent engaging into a socket.

## Transportation

1. Disconnect charger from power supply and remove the battery pack.
2. Protect the product from any heavy impact or strong vibrations which may occur during transportation in vehicles.
3. Secure the product to prevent it from slipping or falling over.

## Storage

1. Disconnect charger from power supply and remove the battery pack.
2. Clean the product as described above.
3. Store the product and its accessories in a dark, dry, frost-free, well-ventilated place.
4. Always store the product in a place that is inaccessible to children. The ideal storage temperature is between 10 °C and 30 °C.
5. We recommend using the original package for storage or covering the product with a suitable cloth or enclosure to protect it against dust.

## Troubleshooting

Suspected malfunctions are often due to causes that the users can fix themselves. Therefore check the product using this section. In most cases the problem can be solved quickly.



**WARNING!** Only perform the steps described within these instructions! All further inspection, maintenance and repair work must be performed by an authorised service centre or a similarly qualified specialist if you cannot solve the problem yourself!

Problem	Possible cause	Solution
1. The charging status indicator light is still off after connecting the charger to the power supply.	1.1.The charger is not well connected to the suitable power supply. 1.2.The charger or its cable is damaged	1.1.Make sure the power supply voltage is same as the charger rating label, and well connected. 1.2.Replace a new charger.
2. The charging status indicator shows green but battery not charged.	2.1.Battery & charger not well contacted.	2.1.Remove the battery and slide it fully in the charger again.

## Recycling and disposal



Waste electrical products should not be disposed of with household waste. Please recycle where facilities exist.

Check with your local authority or local store for recycling advice.

**For further information visit [www.recycle-more.co.uk](http://www.recycle-more.co.uk).**



### Guarantee

We take special care to select high quality materials and use manufacturing techniques that allow us to create products incorporating design and durability. This product (**Erbauer** Battery Charger) has a manufacturer's guarantee of 2 years against manufacturing defects, from the date of purchase (if bought in store) or date of delivery (if bought online), at no additional cost.

To make a claim under this guarantee, you must present your proof of purchase (such as a sales receipt, purchase invoice or other evidence admissible under applicable law), please keep your proof of purchase in a safe place. For this guarantee to apply, the product you purchased must be new, it will not apply to second hand or display products. Unless stated otherwise by applicable law, any replacement product issued under this guarantee will only be guaranteed until expiry of the original guarantee period.

This guarantee covers product failures and malfunctions provided the product was used for the purpose for which it is intended and subject to installation, cleaning, care and maintenance in accordance with the information contained in these terms and conditions, in the user manual and standard practice, provided that standard practice does not conflict with the user manual.

This guarantee does not cover defects and damage caused by normal wear and tear or damage that could be the result of improper use, faulty installation or assembly, neglect, accident, misuse, or modification of the product. Unless stated otherwise by applicable law, this guarantee will not cover, in any case, ancillary costs (shipping, movement, costs of uninstalling and reinstalling, labour etc), or direct and indirect damage.

This guarantee does not cover defects and damage caused by or resulting from:

- Normal wear and tear
- Overload, misuse or neglect
- Repairs attempted by anyone other than an authorised agent
- Cosmetic damage
- Damage caused by foreign objects, substances or accidents
- Accidental damage or modification
- Failure to follow manufacturer's guidelines



EN

## Loss of use of the goods

If the product is defective, we will, within a reasonable time, repair or replace it. Rights under this guarantee are enforceable in the country in which you purchased this product. Guarantee related queries should be addressed to the store you purchased this product from.

The guarantee is in addition to and does not affect your statutory rights.





## Declaration of conformity



(EN) EU DECLARATION OF CONFORMITY  
 (FR) DÉCLARATION UE DE CONFORMITÉ  
 (PL) DEKLARACJA ZGODNOŚCI UE  
 (RO) DECLARAȚIA DE CONFORMITATE UE  
 (ES) DECLARACIÓN UE DE CONFORMIDAD  
 (PT) DECLARAÇÃO DE CONFORMIDADE UE

Product/ Produit/ Produkt/Produsul/Producto/Producto		
<ul style="list-style-type: none"> <li>12V CHARGER/ CHARGEUR 12V/ŁADOWARKA 12V/ÎNCĂRCĂTOR 12V/CARGADOR 12V/CARREGADOR DE 12V</li> <li>EBFC12-Li/EBC12-Li</li> <li>Serial number: 000001-999999/ Serial no. 000001-999999/ Numer seryjny: 000001-999999          Număr de serie: de la 000001 la 999999/ Número de serie: 000001-999999/ Número de série: 000001-999999</li> </ul>		
Name and address of the manufacturer or his authorised representative: Nom et adresse du fabricant ou de son mandataire: Nazwa i adres producenta lub jego upoważnionego przedstawiciela: Denumirea și adresa producătorului sau a reprezentantului său autorizat: Nombre y dirección del fabricante o de su representante autorizado: Nome e endereço do fabricante ou do respetivo mandatário:		
Kingfisher International Products B.V., Rapenburgerstraat 175E, 1011 VM Amsterdam, The Netherlands		
This declaration of conformity is issued under the sole responsibility of the manufacturer: La présente déclaration de conformité est établie sous la seule responsabilité du fabricant: Niniejsza deklaracja zgodności wydana zostaje na wyłączną odpowiedzialność producenta: Declarația de conformitate este emisă pe răspunderea exclusivă a producătorului: La presente declaración de conformidad se expide bajo la exclusiva responsabilidad del fabricante: A presente declaração de conformidade é emitida sob a exclusiva responsabilidade do fabricante:		
Object of the declaration/Objet de la déclaration/Przedmiot deklaracji/Obiectul declarației/Objeto de la declaración/Objeto da declaração		
Product/Produit/Produkt/Produsul/Producto/Producto	Model/Modèle/Model/Modelul/Modelo/Modelo	EAN
12V CHARGER CHARGEUR 12V ŁADOWARKA 12V ÎNCĂRCĂTOR 12V CARGADOR 12V CARREGADOR DE 12V	EBFC12-Li/ EBC12-Li	5059340010809 /-(UK) 5059340010816 /-(EU)
The object of the declaration described above is in conformity with the relevant Union harmonisation legislation: L'objet de la déclaration décrit ci-dessus est conforme à la législation d'harmonisation de l'Union applicable: Wymieniony powyżej przedmiot niniejszej deklaracji jest zgodny z odpowiednimi wymaganiami unijnego prawodawstwa harmonizacyjnego: Obiectul declarației descris mai sus este în conformitate cu legislația relevantă de armonizare a Uniunii: El objeto de la declaración descrita anteriormente es conforme con la legislación de armonización pertinente de la Unión: O objeto da declaração acima descrito está em conformidade com a legislação de harmonização da União aplicável:		
2014/30/EU as amended Directive Electromagnetic compatibility 2014/35/EU Directive Electrical Safety: Low-voltage electrical equipment 2011/65/EU as amended Directive Restriction of the use of certain hazardous substances in electrical and electronic equipment		
2014/30 / UE telle que modifiée Directive Compatibilité électromagnétique 2014/35/UE Directive Sécurité électrique: matériel électrique à basse tension Directive 2011/65/UE relative à la limitation de l'utilisation de certaines substances dangereuses dans les équipements électriques et électroniques		
2014/30 / UE ze zmianami Dyrektywa Kompatybilność elektromagnetyczna 2014/35/UE Dyrektywa Bezpieczeństwo elektryczne: sprzęt elektryczny niskiego napięcia 2011/65 / UE ze zmianami Dyrektywa Ograniczenie stosowania niektórych niebezpiecznych substancji w sprzęcie elektrycznym i elektronicznym		
2014/30/UE, astfel a fost modificată Directiva privind compatibilitatea electromagnetică Directiva 2014/35/UE siguranța electrică: echipamente electrice de joasă tensiune 2011/65/UE, astfel a fost modificată Directiva privind limitarea utilizării anumitor substanțe periculoase în echipamentele electrice și electronice		
2014/30/UE modificada Directiva Compatibilidad electromagnética 2014/35/UE Directiva Seguridad Eléctrica: Equipos eléctricos de baja tensión 2011/65/UE modificada Directiva Restricción del uso de determinadas sustancias peligrosas en equipos eléctricos y electrónicos		

2014/30/UE como alteração da compatibilidade eletromagnética  
 2014/35/Diretiva UE Segurança Elétrica: Equipamento elétrico de baixa tensão  
 2011/65/UE como restrição diretiva alterada da utilização de certas substâncias perigosas em equipamentos elétricos e eletrônicos

References to the relevant harmonised standards used or references to the other technical specifications in relation to which conformity is declared:

Références des normes harmonisées pertinentes appliquées, y compris la date de celles-ci, ou des autres spécifications techniques, y compris la date de celles-ci, par rapport auxquelles la conformité est déclarée:

Odwolania do odnośnych norm zharmonizowanych, które zastosowano, wraz z datą normy, lub do innych specyfikacji technicznych, wraz z datą specyfikacji, w odniesieniu do których deklarowana jest zgodność:

Trimeri la standardele armonizate relevante folosite, inclusiv data standardului, sau trimeri la cealalte specificații tehnice, inclusiv data specificațiilor, în legătură cu care se declară conformitatea:

Referencias a las normas armonizadas pertinentes utilizadas, incluidas las fechas de las normas, o referencias a las otras especificaciones técnicas, incluidas las fechas de las especificaciones, respecto a las cuales se declara la conformidad:

Referências às normas harmonizadas aplicáveis utilizadas, incluindo a data da norma, ou às outras especificações técnicas, incluindo a data da especificação, em relação às quais é declarada a conformidade:

EN 60335-1: 2012+A11: 2014+A13: 2017+A1: 2019+A14: 2019+A2: 2019

EN 60335-2-29: 2004+A2: 2010+A11: 2018

EN 62233: 2008

EN 55014-1:2017+A11: 2020

EN IEC 55014-1:2021

EN 55014-2: 2015

EN IEC 55014-2:2021

EN IEC 61000-3-2:2019

EN IEC 61000-3-2:2019+A1:2021

EN 61000-3-3:2013+A1:2019

Signed for and on behalf of/Signé par et au nom de/ Podpisano w imieniu/Semnat pentru și în numele/ Firmado en nombre de/ Assinado por e em nome de:

Kingfisher International Products B.V.,  
 Rapenburgerstraat 175E,  
 1011 VM Amsterdam,  
 The Netherlands

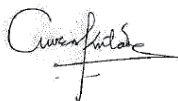

David Awe  
 Group Quality Director

: 21/07/2021

**UK  
CA**  
**(UK) DECLARATION OF CONFORMITY**

**Product**

- 12V CHARGER
- EBFC12-Li / EBC12-Li
- Serial number: 000001-999999

Name and address of the manufacturer or his authorised representative:

Kingfisher International Products Limited  
3 Sheldon Square  
London W2 6PX  
United Kingdom

This declaration of conformity is issued under the sole responsibility of the manufacturer.

**Object of the declaration**

Product	Model	EAN
12V CHARGER	EBFC12-Li / EBC12-Li	5059340010809 /-

The object of the declaration described above is in conformity with the relevant legislation:

Electrical Equipment (Safety) Regulation 2016 as amended  
Electromagnetic Compatibility Regulations 2016 as amended  
The Restriction of the use of Certain Hazardous Substances in Electrical and Electronic Equipment Regulations 2012 as amended

References to the relevant designated standards used or references to the other technical specifications in relation to which conformity is declared:

EN 60335-1: 2012+A11: 2014+A13: 2017+A1: 2019+A14: 2019+A2: 2019  
EN 60335-2-29: 2004+A2: 2010+A11: 2018  
EN 62233: 2008  
BS EN 60335-1:2012+A2:2019  
BS EN 60335-2-29:2004+A11:2018  
BS EN 62233:2008  
EN 55014-1:2017+A11: 2020  
EN IEC 55014-1:2021  
EN 55014-2: 2015  
EN IEC 55014-2:2021  
EN IEC 61000-3-2:2019  
EN IEC 61000-3-2:2019+A1:2021  
EN 61000-3-3:2013+A1:2019  
BS EN 55014-1:2017+A11: 2020  
BS EN IEC 55014-1:2021  
BS EN 55014-2:2015  
BS EN IEC 55014-2:2021  
BS EN IEC 61000-3-2:2019  
BS EN IEC 61000-3-2:2019+A1:2021  
BS EN 61000-3-3:2013+A1:2019

Signed for and on behalf of:

Kingfisher International Products Limited  
3 Sheldon Square  
London W2 6PX  
United Kingdom

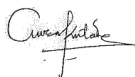

David Awe  
Group Quality Director

On: 21/07/2021



**Manufacturer • Fabricant • Producent • Producător • Fabricante:**

**UK manufacturer:**

Kingfisher International Products Limited  
3 Sheldon Square London W2 6PX  
United Kingdom  
[www.kingfisher.com/products](http://www.kingfisher.com/products)

**EU manufacturer:**

Kingfisher International Products B.V.  
Rapenburgerstraat 175E  
1011 VM Amsterdam  
The Netherlands

[www.diy.com](http://www.diy.com) | [www.screwfix.com](http://www.screwfix.com) | [www.screwfix.ie](http://www.screwfix.ie)

To view instruction manuals online,  
visit [www.kingfisher.com/products](http://www.kingfisher.com/products)

Customer Helpline:

UK 03301248111 [erbauer@powertoolservicing.co.uk](mailto:erbauer@powertoolservicing.co.uk)

Eire 0035312479977 [erbauer@powertoolservicing.co.uk](mailto:erbauer@powertoolservicing.co.uk)