

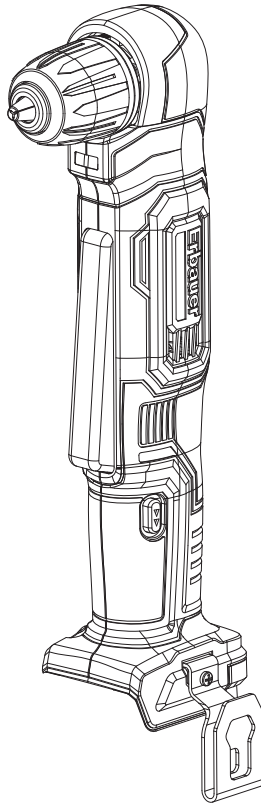

Erbauer



Original Instructions - MNL_EAD12-Li_GB_V11_211013

EAN: 5059340010670

EAD12-Li

ORIGINAL INSTRUCTIONS







EN



V110421 / BX220IM



EN

	Safety instructions	8
	Product description	21
	Assembly	23
	Use	26
	Care & maintenance	30
	Guarantee	34
	Declaration of conformity	35



WARNING! Please read all safety warnings carefully and be sure that they are fully understood before handling the tool.

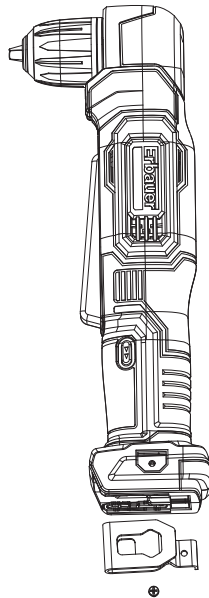
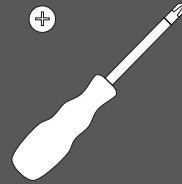



EN



Product description

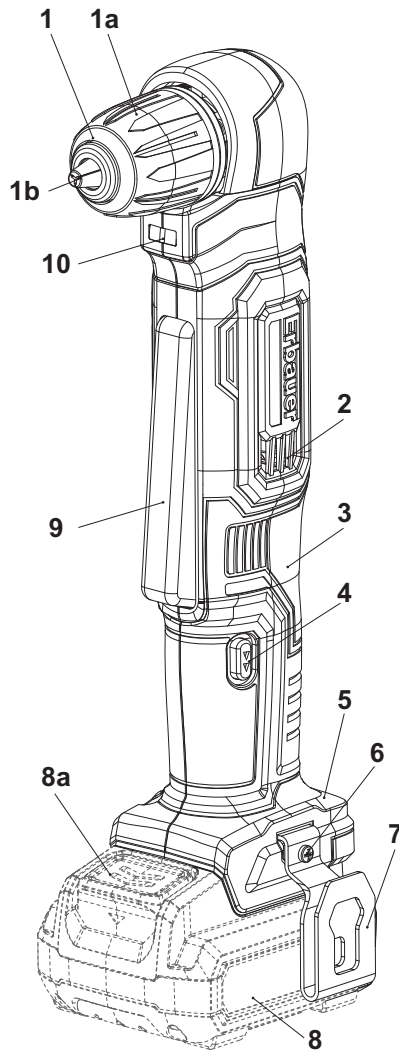



A

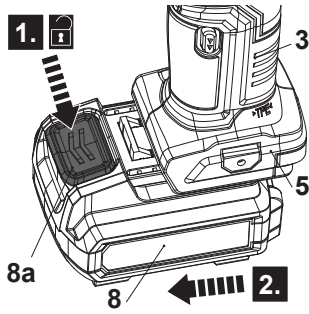

B

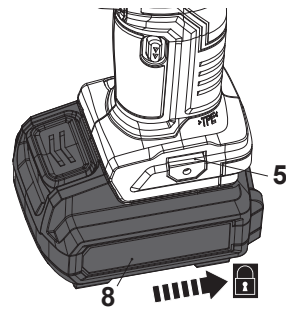

C

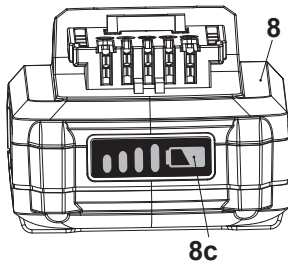

D

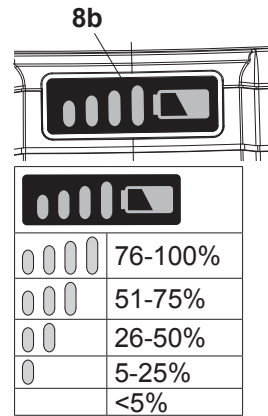

E

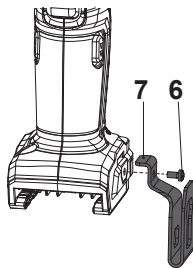

F

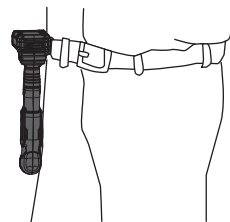



EN

G

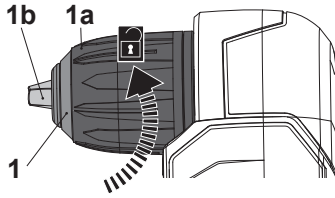

H

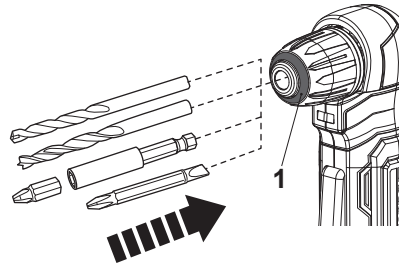

I

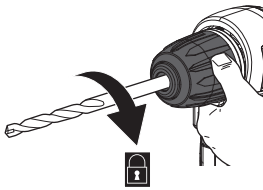

J

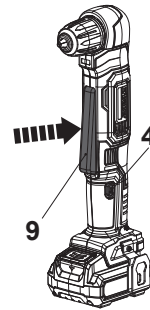

K

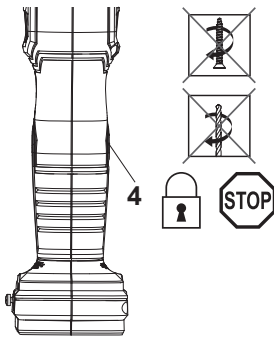

L

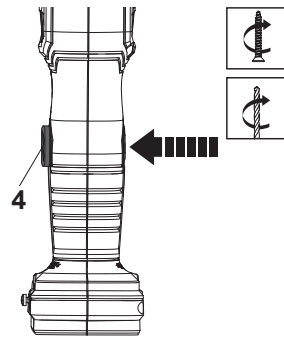



M

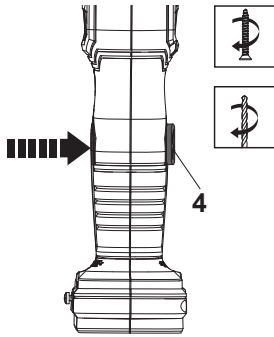

N

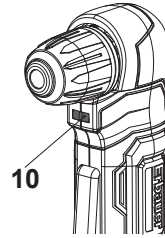



Safety instructions

GENERAL POWER TOOL SAFETY WARNINGS



WARNING! Read all safety warnings, instructions, illustrations and specifications provided with this power tool. Failure to follow all instructions listed below may result in electric shock, fire and/or serious injury.

Save all warnings and instructions for future reference. The term “power tool” in the warnings refers to your mains-operated (corded) power tool or battery-operated (cordless) power tool.

WORK AREA SAFETY

- a) **Keep work area clean and well lit.** *Cluttered or dark areas invite accidents.*
- b) **Do not operate power tools in explosive atmospheres, such as in the presence of flammable liquids, gases or dust.** *Power tools create sparks which may ignite the dust or fumes.*
- c) **Keep children and bystanders away while operating a power tool.** *Distractions can cause you to lose control.*

ELECTRICAL SAFETY

- a) **Power tool plugs must match the outlet. Never modify the plug in any way. Do not use any adapter plugs with earthed (grounded) power tools.** *Unmodified plugs and matching outlets will reduce risk of electric shock.*
- b) **Avoid body contact with earthed or grounded surfaces, such as pipes, radiators, ranges and refrigerators.** *There is an increased risk of electric shock if your body is earthed or grounded.*

- c) **Do not expose power tools to rain or wet conditions.** *Water entering a power tool will increase the risk of electric shock.*
- d) **Do not abuse the cord. Never use the cord for carrying, pulling or unplugging the power tool. Keep cord away from heat, oil, sharp edges or moving parts. Damaged or entangled cords increase the risk of electric shock.**
- e) **When operating a power tool outdoors, use an extension cord suitable for outdoor use.** *Use of a cord suitable for outdoor use reduces the risk of electric shock.*
- f) **If operating a power tool in a damp location is unavoidable, use a residual current device (RCD) protected supply.** *Use of an RCD reduces the risk of electric shock.*

PERSONAL SAFETY

- a) **Stay alert, watch what you are doing and use common sense when operating a power tool. Do not use a power tool while you are tired or under the influence of drugs, alcohol or medication.** *A moment of inattention while operating power tools may result in serious personal injury.*
- b) **Use personal protective equipment. Always wear eye protection.** *Protective equipment such as dust mask, non-skid safety shoes, hard hat, or hearing protection used for appropriate conditions will reduce personal injuries.*
- c) **Prevent unintentional starting. Ensure the switch is in the off-position before connecting to power source and/or battery pack, picking up or carrying the tool.** *Carrying power tools with your finger on the switch or energising power tools that have the switch on invites accidents.*
- d) **Remove any adjusting key or wrench before turning the power tool on.** *A wrench or a key left attached to a rotating part of the power tool may result in personal injury.*

- e) **Do not overreach. Keep proper footing and balance at all times.** *This enables better control of the power tool in unexpected situations.*
- f) **Dress properly. Do not wear loose clothing or jewellery. Keep your hair, clothing and gloves away from moving parts.** *Loose clothes, jewellery or long hair can be caught in moving parts.*
- g) **If devices are provided for the connection of dust extraction and collection facilities, ensure these are connected and properly used.** *Use of dust collection can reduce dust-related hazards.*
- h) **Do not let familiarity gained from frequent use of tools allow you to become complacent and ignore tool safety principles.** *A careless action can cause severe injury within a fraction of a second.*

POWER TOOL USE AND CARE

- a) **Do not force the power tool. Use the correct power tool for your application.** *The correct power tool will do the job better and safer at the rate for which it was designed.*
- b) **Do not use the power tool if the switch does not turn it on and off.** *Any power tool that cannot be controlled with the switch is dangerous and must be repaired.*
- c) **Disconnect the plug from the power source and/or remove the battery pack, if detachable, from the power tool before making any adjustments, changing accessories, or storing power tools.** *Such preventive safety measures reduce the risk of starting the power tool accidentally.*
- d) **Store idle power tools out of the reach of children and do not allow persons unfamiliar with the power tool or these instructions to operate the power tool.** *Power tools are dangerous in the hands of untrained users.*

- e) **Maintain power tools and accessories.** Check for misalignment or binding of moving parts, breakage of parts and any other condition that may affect the power tool's operation. If damaged, have the power tool repaired before use. *Many accidents are caused by poorly maintained power tools.*
- f) **Keep cutting tools sharp and clean.** *Properly maintained cutting tools with sharp cutting edges are less likely to bind and are easier to control.*
- g) **Use the power tool, accessories and tool bits etc. in accordance with these instructions, taking into account the working conditions and the work to be performed.** *Use of the power tool for operations different from those intended could result in a hazardous situation.*
- h) **Keep handles and grasping surfaces dry, clean and free from oil and grease.** *Slippery handles and grasping surfaces do not allow for safe handling and control of the tool in unexpected situations.*

BATTERY TOOL USE AND CARE

- a) **Recharge only with the charger specified by the manufacturer.** *A charger that is suitable for one type of battery pack may create a risk of fire when used with another battery pack.*
- b) **Use power tools only with specifically designated battery packs.** *Use of any other battery packs may create a risk of injury and fire.*
- c) **When battery pack is not in use, keep it away from other metal objects, like paper clips, coins, keys, nails, screws or other small metal objects that can make a connection from one terminal to another.** *Shorting the battery terminals together may cause burns or a fire.*
- d) **Under abusive conditions, liquid may be ejected from the battery; avoid contact. If contact accidentally occurs, flush with water. If liquid contacts eyes, additionally seek medical help.** *Liquid ejected from the battery may cause irritation or burns.*

- e) **Do not use battery pack or tool that is damaged or modified.** *Damaged or modified batteries may exhibit unpredictable behaviour resulting in fire, explosion or risk of injury.*
- f) **Do not expose a battery pack or tool to fire or excessive temperature.** *Exposure to fire or temperature above 130 °C may cause explosion.*
- g) **Follow all charging instructions and do not charge the battery pack or tool outside the temperature range specified in the instructions.** *Charging improperly or at temperatures outside the specified range may damage the battery and increase the risk of fire.*

SERVICE

- a) **Have your power tools serviced by a qualified repair person using only identical replacement parts.** *This will ensure that safety of the power tool is maintained.*
- b) **Never service damaged battery packs.** *Service of battery packs should only be performed by the manufacturer or authorized service providers.*

DRILL SAFETY WARNINGS

Safety instructions for all operations

- a) **Hold the power tool by insulated gripping surfaces, when performing an operation where the cutting accessory or fasteners may contact hidden wiring.** *Cutting accessory contacting a “live” wire may make exposed metal parts of the power tool “live” and could give the operator an electric shock.*

Safety instructions when using long drill bits

- a) **Never operate at higher speed than the maximum speed rating of the drill bit.** *At higher speeds, the bit is likely to bend if allowed to rotate freely without contacting the workpiece, resulting in personal injury.*



- b) **Always start drilling at low speed and with the bit tip in contact with the workpiece.** *At higher speeds, the bit is likely to bend if allowed to rotate freely without contacting the workpiece, resulting in personal injury.*
- c) **Apply pressure only in direct line with the bit and do not apply excessive pressure.** *Bits can bend causing breakage or loss of control, resulting in personal injury.*

ADDITIONAL SAFETY WARNINGS FOR ANGLE DRILL

- a) **Switch the power tool off immediately if the application tool becomes blocked.** *Be prepared for high torque reactions which cause kickback. The application tool becomes blocked when it becomes jammed in the workpiece or when the power tool becomes overloaded.*
- b) **Hold the power tool securely.** *When tightening and loosening screws be prepared for temporarily high torque reactions.*
- c) **Secure the workpiece.** *A workpiece clamped with clamping devices or in a vice is held more secure than by hand.*
- d) **Use suitable detectors to determine if there are hidden supply lines or contact the local utility company for assistance.** *Contact with electric cables can cause fire and electric shock. Damaging gas lines can lead to explosion. Breaking water pipes causes property damage.*
- e) **Always wait until the power tool has come to a complete stop before placing it down.** *The application tool can jam and cause you to lose control of the power tool.*

ADDITIONAL SAFETY WARNINGS FOR BATTERY PACK

- a) **Observe the plus (+) and minus (-) marks on the battery and ensure correct use.**
- b) **Do not connect the positive terminal and negative terminal of the battery to each other with any metal object (such as wire).**

- c) Do not carry or store battery together with necklaces, hairpins or other metal objects.
- d) Do not pierce the battery with nails, strike the battery with a hammer, step on the battery or otherwise subject it to strong impacts or shocks.
- e) Do not solder directly onto the battery.
- f) Do not mix cells of different manufacture, capacity, size or type within a device.
- g) Do not expose battery to water or salt water, or allow the battery to get wet.
- h) Do not disassemble or modify the battery. There is a risk of short-circuiting.
- i) Do not place the battery in or near fire, on stoves or other high temperature locations.
- j) Do not place the battery in microwave ovens, high-pressure containers or on induction cookware.
- k) Do not place the battery in direct sunlight, or use or store the battery inside cars in hot weather.
- l) If you intend to store a battery for a period without use then store battery at room temperature (19 °C to 25 °C), charged to about 30 – 50% of capacity. When storing for very long periods boost charge the battery once per year to prevent over discharge.
- m) Wipe the battery pack terminals with a clean dry cloth if they become dirty.
- n) Battery pack needs to be charged before use. Always refer to the charger instruction and use the correct charging procedure.
- o) After extended periods of storage, it may be necessary to charge and discharge the battery pack several times to obtain maximum performance.
- p) Battery pack gives its best performance when it is operated at normal room temperature (20 °C±5 °C).
- q) Keep battery pack out of the reach of children.
- r) Retain the original product literature for future reference.



- s) Remove the battery from the drill or charger when not in use.

The following information applies to professional users only but is good practice for all users:

ADDITIONAL SAFETY WARNING FOR CONSTRUCTION DUST

The updated Control of Substances Hazardous to Health Regulations 1st October 2012 now also targets to reduce the risks associated with silica, wood and gypsum dusts.

Construction workers are one of the at-risk groups within this because of the dust that they breathe: silica dust is not just a nuisance; it is a real risk to your lungs!

Silica is a natural mineral present in large amounts in things like sand, sandstone and granite. It is also commonly found in many construction materials such as concrete and mortar. The silica is broken into very fine dust (also known as Respirable Crystalline Silica or RCS) during many common tasks such as cutting, drilling and grinding. Breathing in very fine particles of crystalline silica can lead to the development of:

- Lung cancer
- Silicosis
- Chronic Obstructive Pulmonary Disorder/Chronic obstructive pulmonary disease (COPD)

And breathing in fine particles of wood dust can lead to the development of Asthma. The risk of lung disease is linked to people who regularly breathe construction dust over a period of time, not on the odd occasion.

To protect the lung, the COSHH Regulations sets a limit on the amount of these dusts that you can breathe (called a Workplace Exposure Limit or WEL) when averaged over a normal working day. These limits are not a large amount of dust: when compared to a penny it is tiny – like a small pinch of salt:



EN

This limit is the legal maximum; the most you can breathe after the right controls have been used.

HOW TO REDUCE THE AMOUNT OF DUST?

- a) Reduce the amount of cutting by using the best sizes of building products.
- b) Use a less powerful tool e.g. a block cutter instead of angle grinder.
- c) Using a different method of work altogether – e.g. using a nail gun to direct fasten cable trays instead of drilling holes first.

Please always work with approved safety equipment, such as those dust masks that specially designed to filter out microscopic particles and use the dust extraction facility at all time.

For more information please see the HSE website: <http://www.hse.gov.uk/construction> or <http://www.hse.gov.uk/pubns/cis69.pdf>



WARNING! Some dust particles created by power sanding, sawing, grinding, drill and other construction jobs contain chemicals known to cause cancer, birth defects or other reproductive harm. Some examples of these chemicals are:

- Lead from lead-based paints.
- Crystalline silica from bricks and cement and other masonry products.
- Arsenic and chromium from chemically treated timber.
- Your risk from these exposures varies, depending upon how often you do this type of work. To reduce your exposure to these chemicals:
- Work in a well-ventilated area.
- Work with approved safety equipment, such as those dust masks that are specially designed to filter microscopic particles.

VIBRATION

The European Physical Agents (Vibration) Directive has been brought in to help reduce hand arm vibration syndrome injuries to power tool users. The directive requires power tool manufacturers and suppliers to provide indicative vibration test results to enable users to make informed decisions as to the period of time a power tool can be used safely on a daily basis and the choice of tool.

SEE TECHNICAL SPECIFICATIONS IN THE INSTRUCTION MANUAL FOR THE VIBRATION LEVELS OF YOUR TOOL.

The declared vibration emission value should be used as a minimum level and should be used with the current guidance on vibration.

Calculating the actual period of use can be difficult and the HSE website has further information.



EN

The declared vibration total value has been measured in accordance with EN 62841-1 and EN 62841-2-1 and may be used for compare one tool with another.

The declared vibration total value may also be used in a preliminary assessment of exposure.



WARNING! The vibration emission during actual use of the power tool can differ from the declared total value depending on the ways in which the tool is used:

- How the materials are grinded, cut or drilled.
- If the tool is in good condition and well maintained.
- Use correct accessory for the tool and ensure it is sharp and in good condition.
- The tightness of the gripping handles.
- The tool is being used as intended by its design and these instructions.

While working with this power tool, hand/arm vibrations occur. Adopt the correct working practices in order to reduce the exposure to vibration. This tool may cause hand-arm vibration syndrome if its use is not adequately managed.



WARNING! Identify safety measures to protect the operator that are based on an estimation of exposure in the actual conditions of use (taking account of all parts of the operating cycle such as the times when the tool is switched off and when it is running idle in addition to the trigger time).

Note:

- The use of other tools will reduce the users' total working period on this tool.
- Helping to minimise your vibration exposure risk. ALWAYS use sharp chisels, drills and blades.
- Maintain this tool in accordance with these instructions and keep well lubricated (where appropriate).
- Avoid using tools in temperatures of 10 °C or less. Plan your work schedule to spread any high vibration tool use across a number of days.

Health surveillance

All employees should be part of an employer's health surveillance scheme to help identify any vibration related diseases at an early stage, prevent disease progression and help employees stay in work.

Vibration and noise reduction

To reduce the impact of noise and vibration emission, limit the time of operation, use low-vibration and low-noise operating modes as well as wear personal protective equipment.

Take the following points into account to minimise the vibration and noise exposure risks:

- a) Only use the product as intended by its design and these instructions.
- b) Ensure that the product is in good condition and well maintained.

- c) Use correct attachments for the product and ensure they are in good condition.
- d) Keep tight grip on the handles/grip surface.
- e) Maintain this product in accordance with these instructions and keep it well lubricated (where appropriate).
- f) Plan your work schedule to spread any high vibration tool use across a longer period of time.
- g) Prolonged use of the product exposes the user to vibrations that can cause a range of conditions collectively known as hand-arm vibration syndrome (HAVS) e.g. fingers going white; as well as specific diseases such as carpal tunnel syndrome. To reduce this risk when using the product, always wear protective gloves and keep your hands warm.

Emergency

Familiarise yourself with the use of this product by means of this instruction manual. Memorise the safety directions and follow them to the letter. This will help to prevent risks and hazards.

- a) **Always be alert when using this product, so that you can recognise and handle risks early.** *Fast intervention can prevent serious injury and damage to property.*
- b) **Switch off and disconnect from the power supply if there are malfunctions.** *Have the product checked by a qualified professional and repaired, if necessary, before you operate it again.*

Residual risks

Even if you are operating this product in accordance with all the safety requirements, potential risks of injury and damage remain. The following dangers can arise in connection with the structure and design of this product:

- a) Health defects resulting from vibration emission if the product is being used over long periods of time or not adequately managed and properly maintained.



- b) Injuries and damage to property due to broken attachments or the sudden impact of hidden objects during use.
- c) Danger of injury and property damage caused by flying objects or poor power tool accessories.



Product description

Part index

The index below refers to Fig. 1 on page 4.

1. Keyless chuck
 - a. Chuck sleeve
 - b. Chuck jaws
2. Air vents
3. Main handle
4. Forward / reverse rotation control
5. Battery pack holder
6. Screw
7. Belt clip
8. Battery pack (not included)
 - a. Release button
 - b. Battery capacity indicators*
 - c. Battery capacity button*
9. On/Off switch
10. LED work light



NOTE: Parts marked with * are not shown in this overview. Please refer to the respective section in the instruction manual.

Technical specifications

Drill

- | | |
|-----------------------------|--------------|
| > Rated voltage | : 12 V d.c. |
| > Rated no load speed n_0 | : 0-800 /min |
| > Max torque | : 25 N.m |

- > Drill chuck capacity : 1.0-10 mm
- > Max. screw diameter : 6 mm
- > Max. drilling capacity : Steel: 10 mm
Wood: 22 mm
- > Weight (without battery pack) : approx. 0.9 kg

For use with battery pack and charger as below:

- > Battery pack model : EHPB12-Li-3 EHPB12-Li-6
- > Charger model : EBC12-Li EBFC12-Li

Ambient temperature range for tool and battery use : 0 °C to 40 °C

Sound values

- > Sound pressure level L_{pA} : 71 dB(A)
- > Uncertainty K_{pA} : 5 dB(A)
- > Sound power level L_{WA} : 82 dB(A)
- > Uncertainty K_{WA} : 5 dB(A)

Hand arm vibration values

- > Drilling into metal : $a_{h,D} = 2.4 \text{ m/s}^2$
- > Uncertainty K : 1.5 m/s^2

The sound intensity level for the operator may exceed 80 dB(A) and ear protection measures are necessary.

The declared vibration total values and the declared noise emission values have been measured in accordance with a standard test method and may be used for comparing one tool with another; they may also be used in a preliminary assessment of exposure.



WARNING! The vibration and noise emissions during actual use of the power tool can differ from the declared values depending on the ways in which the tool is used especially what kind of workpiece is processed; and need to identify safety measures to protect the operator that are based on an estimation of exposure in the actual conditions of use (taking account of all parts of the operating cycle such as the times when the tool is switched off and when it is running idle in addition to the trigger time).

Rating label explanation



EAD12-Li = Model number
 E = Erbauer
 AD = Angle Drill
 12 = 12 V d.c.
 Li = LITHIUM ION



Assembly

01 Symbols

On the product, the rating label and within these instructions you will find among others the following symbols and abbreviations. Familiarise yourself with them to reduce hazards like personal injuries and damage to property.

V ~	Volt, (alternating voltage)	mm	Millimetre
Hz	Hertz	kg	Kilogram
A	Ampere	ml	Millilitre
°C	Degree Celsius	n_0	No-load speed
W	Watt	dB(A)	Decibel (A-rated)
/min or min ⁻¹	Per minute	m/s ²	Metres per seconds squared
	Lock / to tighten or secure.		Unlock / to loosen.



Read the instruction manual.



Always wear eye protection.



Always wear ear protection.



Wear a dust mask.



Wear protective gloves.



Wear protective, slip-resistant footwear.



Note / Remark.



Caution / Warning.

xxWyy

Manufacturing date code; year of manufacturing (20xx) and week of manufacturing (Wyy)



Switch the product off and remove battery pack before assembly, cleaning, adjustments, maintenance, storage and transportation.



Open flames in the work area, around the product and in the vicinity of flammable materials are prohibited!



Do not smoke in the work area, around the product and in the vicinity of flammable materials!



WEEE symbol. Waste electrical products should not be disposed of with household waste. Please recycle where facilities exist. Check with your Local Authority or local store for recycling advice.



Crossed out dust bin. Batteries and battery packs should not be disposed of with household waste. Please recycle where facilities exist. Check with your Local Authority or local store for recycling advice.

EN



Do not dispose of battery packs in rivers or immerse in water.



Do not dispose of battery packs in fire. They will explode and cause injury.



Do not expose battery packs to heat in excess of 45 °C. Do not charge or store the battery pack in temperatures below 0 °C (32 °F) and above 45 °C (113°F).



The product complies with the applicable European directives and an evaluation method of conformity for these directives was done.



UK Conformity Assessed.

02 Unpacking

1. Unpack all parts and lay them on a flat, stable surface.
2. Remove all packing materials and shipping devices, if applicable.
3. Make sure the delivery contents are complete and free of any damage. If you find that parts are missing or show damage, do not use the product but contact your dealer. Using an incomplete or damaged product represents a hazard to people and property.
4. Ensure all the accessories and tools needed for assembly and operation are at your disposal, including suitable personal protective equipment.



WARNING! The product and the packaging are not children's toys! Keep plastics bags, sheets and small parts away from children. There is a danger of choking and suffocation!



Do not insert the battery pack before the power tool is completely assembled!



NOTE: Take care of small parts that are removed during assembly or when making adjustments. Keep them secure to avoid loss.

03 Setup

BATTERY PACK (NOT INCLUDED)

Release / Attach

1. Lock the On/Off switch (8) to avoid accidental starting by moving the forward / reverse rotation control (4) into the middle position (See below section “Controls – Forward / reverse rotation control”).
2. To remove the battery pack, press down the release button (8a) and pull out the battery pack (8) from the battery pack holder (5) (Fig. A).
3. Align and slide the battery pack (8) to the battery pack holder (5). Ensure that it clicks in place (Fig. B).

Charging the battery pack

The battery has been shipped in a low charge condition. Charge it fully before first use. Refer to the charger instruction manual for the details.

Battery capacity indicators

The battery pack (8) is equipped with battery capacity indicators (8b) which are used to give an indication of the battery pack's remaining capacity. Press the battery capacity button (8c) to check battery capacity (Figs. C, D). The LEDs will stay lit for approximately 5 seconds.

BELT CLIP

The belt clip (7) can be assembled on the either side of the angle drill.

1. Set the forward / reverse rotation control (4) in the middle position (lock).
2. Attach the belt clip (7) properly to the slot and fix it with screw (6) in clockwise direction (Fig. E).
3. The belt clip (7) can be hooked on your belt or pocket, etc (Fig. F).

DRILL AND DRIVER BITS

Different drill and driver bits can be used with this product depending on the material being worked with.



WARNING! Always use drill bits according to the intended use! For example, never use drill bit intended for working on wood for working on metal or vice versa!



Observe the technical requirements of this product (see section Technical specifications) when purchasing and using drill bits and driver bits! Some drill bits are very sharp and become hot during use! Handle them carefully! Wear protective gloves when handling drill bits in order to avoid injuries like burns and cuts!

Inserting

1. Turn the chuck sleeve (1a) anticlockwise until the chuck jaws (1b) are opened wide enough to insert the bit (Fig. G).



EN

2. Insert the bit all the way to the stop of the keyless chuck (1) (Fig. H).



NOTE: If using a short driver bit of 25 mm, please insert it into the socket of an extension bit holder.

3. Turn the chuck sleeve (1a) clockwise until the drill or driver bit is properly fastened in the chuck jaws (1b) (Fig. I).



WARNING! After short operation, switch the product off and check once again that the bit is properly fastened!
Caution! The drill bit could be hot!



Replacing / Removing

1. Turn the chuck sleeve (1a) anticlockwise until the chuck jaws (1b) are opened wide enough to remove the bit.
2. Remove the bit and insert a new one as described above if desired.



Use

Intended use

This product is intended for drilling in wood and similar materials e.g. MDF, plywood, plastic, metal, as well as for screw driving, especially where space is restricted. It should not be used for working on materials that are dangerous to health.

For safety reasons it is essential to read the entire instruction manual before first operation and to observe all the instructions therein.

This product must not be used for any purposes other than those described.

Before you start

01 Protection



Controls

01 Switching On/Off

Ensure the forward / reverse rotation control (4) is not on centre lock position.

1. Switch the product on by pressing the On/Off switch (9) (Fig. J).
2. Switch the product off by releasing the On/Off switch (9).

The On/Off switch (9) is fitted with a brake function which stops your chuck immediately when you quickly release the switch.

The ON/OFF switch (9) is fitted with a built-in speed control. The speed is controlled by how far the trigger switch is pressed.

02 Switch lock

The switch trigger can be locked at the OFF position. This helps to reduce the possibility of accidental starting when not in use.

Move the forward / reverse rotation control (4) to the centre position to lock the On/Off switch (9) and avoid accidental starting (Fig. K).

03 Forward / reverse rotation controls

Change the rotational direction from forward to reverse by pressing the forward / reverse rotation control (4).



WARNING! Only change the rotational direction when the product is switched off and has come to a complete stop! Always ensure that the forward / reverse rotation control (4) is adjusted to the correct position depending on the intended operation!

Always push the forward / reverse rotation control (4) as far as it will go!
Do not use the product with the control switch in any other position!



EN

1. Move the forward / reverse rotation control (4) to the left (as seen from the operator's position) in order to use the product in a clockwise rotational mode (Fig. L).
2. Move the forward / reverse rotation control (4) to the right (as seen from the operator's position) in order to use the product in anticlockwise rotational mode (Fig. M).

04 Automatic spindle lock

The automatic spindle lock allows you to use it as a regular screwdriver. You can give an extra twist to firmly tighten a screw, loosen a very tight screw or continue working when the battery energy has expired. For manual screwdriver purposes, the chuck is automatically locked when the tool is off.

05 Automatic work light

The LED work light (10) will illuminate when the trigger of On/Off switch (9) is depressed slightly, and will automatically turn off a short while after the trigger of On/Off switch (9) is released (Fig. N). This provides additional light on the surface of the workpiece for operation in lower light situations.



WARNING! Do not look directly into the light.

Operation

1. Check the product, as well as accessories for damage before each use. Do not use the product if it is damaged or shows wear.
2. Double check that the accessories and attachments are properly fixed.
3. Always hold the product on its handles. Keep the handles dry to ensure safe support.
4. Ensure that the air vents are always unobstructed and clear. Clean them if necessary with a soft brush. Blocked air vents may lead to overheating and damage the product.
5. Switch the product off immediately if you are disturbed while working by other people entering the working area. Always let the product come to complete stop before putting it down.
6. Do not overwork yourself. Take regular breaks to ensure you can concentrate on the work and have full control over the product.



WARNING! Keep in mind that there are buried objects hidden in every household! Ensure that there are no gas, water or power lines hidden in the working area that may be hit before operation – danger of electrical shock and serious damage to people and property! Use a suitable detector to trace such objects in advance!

01 Drilling

1. Ensure that correct drill bit is applied and all controls are set in correction position.
2. Always hold the product perpendicular to the point to be drilled. Holding it at an angle may cause slipping or jamming of the drill bit. Loss of control can cause personal injury.
3. Always place the drill tip directly on the point to be drilled first and then switch the product on.
4. Pre-drill larger holes with a small diameter drill bit first. Doing so makes drilling with a larger diameter drill bit easier.
5. Apply proper feeding force and rotation speed depending on drill bit characteristics and material to be drilled. Too big feeding force will overload the power tool, damage the drill bit due to overheating, decrease drilling effectivity and increase the risk of loss of control. Ask a drill bit specialist for advice if necessary.
6. If the drill bit gets stuck in the workpiece, switch the power tool off and try to draw it perpendicularly out of the workpiece with slight force in order that the drill bit and the workpiece surface will not be damaged. If this does not work, switch to reverse rotation mode and press the On/Off switch in inching mode, then draw the drill bit perpendicularly out of the workpiece with slight force.
7. Check the drill bit and its clamping status regularly during work, refit or replace it if necessary.



NOTE: When operating the product at a lower speed for a longer period the motor may overheat. Therefore take breaks of approx. 5 minutes on a regular basis to let the motor cool down.

Additional tips for drilling into metal

1. Punch the drilling point before operation in order to avoid slipping of the drill bit.
2. Start with low speed and feeding force before the drill bit tip is well seated in workpiece.
3. Where necessary use a cooling lubricant that is available at power tool dealer, especially when drilling iron-metal.

02 Screw driving

1. Pre-drill the holes with a smaller diameter than the screw to be driven.
2. Hold the product perpendicular to the screw to be driven in/out. Holding it at an angle may cause slipping or jamming of the driver bit.
3. Place the tip of the driver bit directly on the screw first and then switch the product on.
4. Only apply as much pressure as necessary to keep the screw in place and the driver bit in contact with the screw head. Too much pressure will cause damage to the screw head and driver bit, too little pressure will cause the driver bit to slide away.
5. Remove blocked and stuck screws by changing the rotational direction.

After use

1. Switch the product off, remove the battery back and let it cool down.
2. Check, clean and store the product as described below.



Care & maintenance



WARNING! Always switch the product off, remove the battery back and let the product cool down before performing inspection, maintenance and cleaning work!



Only perform care and maintenance work according to these instructions!
All further works must be performed by a qualified specialist!

Clean

1. Clean the product with a dry cloth. Use a brush for areas that are hard to reach.
2. In particular clean the switches and air vents after every use with a cloth and brush.
3. Remove stubborn dust with high pressure air (max. 3 bar).
4. Check for worn or damaged parts. Replace worn parts as necessary or contact an authorised service centre for repair before using the product again.



Do not use chemical, alkaline, abrasive or other aggressive detergents or disinfectants to clean this product as they might be harmful to its surfaces.

Maintenance

Your tool requires no additional lubrication or maintenance. There are no user serviceable parts in your tool.

Transportation

1. Switch the product off and remove the battery pack.
2. Protect the product from any heavy impact or strong vibrations which may occur during transportation in vehicles.
3. Secure the product to prevent it from slipping or falling over.

Storage

1. Switch the product off and remove the battery pack.
2. Clean the product as described above.
3. Store the product and its accessories in a dark, dry, frost-free, well-ventilated place.
4. Always store the product in a place that is inaccessible to children. The ideal storage temperature is between 10 °C and 30 °C.
5. We recommend using the original package for storage or covering the product with a suitable cloth or enclosure to protect it against dust.

Troubleshooting

Suspected malfunctions are often due to causes that the users can fix themselves. Therefore check the product using this section. In most cases the problem can be solved quickly.



WARNING! Only perform the steps described within these instructions! All further inspection, maintenance and repair work must be performed by an authorised service centre or a similarly s specialist if you cannot solve the problem yourself!

Problem	Possible cause	Solution
1. Product does not start	1.1. Forward / reverse rotation control switch at centre lock position 1.2. Battery pack not properly attached 1.3. Battery pack discharged 1.4. Battery pack damaged 1.5. Other electrical defect to the product	1.1. Push forward / reverse rotation control switch to left / right 1.2. Attach properly 1.3. Remove and charge battery pack 1.4. Check by a specialist electrician 1.5. Check by a specialist electrician
2. Product does not reach full power	2.1. Battery pack capacity too low 2.2. Air vents are blocked	2.1. Charge battery pack 2.2. Clean the air vents
3. Unsatisfactory result	3.1. Drill / driver bit is worn 3.2. Drill / driver bit not suitable for intended operation	3.1. Replace with a new one 3.2. Use suitable drill / driver bit
4. Product suddenly stops	4.1. Product overloaded 4.2. Battery pack discharged 4.3. Battery too hot	4.1. Remove the product from the workpiece and switch it on again 4.2. Remove and charge battery pack 4.3. Remove battery pack and let it cool down
5. Excessive vibration or noise	5.1. Drill bit is dull / damaged	5.1. Replace with a new one



Recycling and disposal



Waste electrical products should not be disposed of with household waste. Please recycle where facilities exist.

Check with your local authority or local store for recycling advice.

For further information visit www.recycle-more.co.uk.

Disposal of an exhausted battery pack



The battery is Li-Ion type. To preserve natural resources, please recycle or dispose of the battery pack properly. Consult your local waste authority for information regarding available recycling and / or disposal options.

Discharge your battery pack by operating your tool, then remove the battery pack from the tool and cover the battery pack connections with heavy duty adhesive tape to prevent short circuit and energy discharge.

Do not attempt to open or remove any of the components.



EN



Guarantee

We take special care to select high quality materials and use manufacturing techniques that allow us to create products incorporating design and durability. This product (**Erbauer** Angle Drill) has a manufacturer's guarantee of 3 years against manufacturing defects, from the date of purchase (if bought in store) or date of delivery (if bought online), at no additional cost.

To make a claim under this guarantee, you must present your proof of purchase (such as a sales receipt, purchase invoice or other evidence admissible under applicable law), please keep your proof of purchase in a safe place. For this guarantee to apply, the product you purchased must be new, it will not apply to second hand or display products. Unless stated otherwise by applicable law, any replacement product issued under this guarantee will only be guaranteed until expiry of the original guarantee period.

This guarantee covers product failures and malfunctions provided the product was used for the purpose for which it is intended and subject to installation, cleaning, care and maintenance in accordance with the information contained in these terms and conditions, in the user manual and standard practice, provided that standard practice does not conflict with the user manual.

This guarantee does not cover defects and damage caused by normal wear and tear or damage that could be the result of improper use, faulty installation or assembly, neglect, accident, misuse, or modification of the product. Unless stated otherwise by applicable law, this guarantee will not cover, in any case, ancillary costs (shipping, movement, costs of uninstalling and reinstalling, labour etc), or direct and indirect damage.

This guarantee does not cover defects and damage caused by or resulting from:

- Normal wear and tear
- Overload, misuse or neglect
- Repairs attempted by anyone other than an authorised agent
- Cosmetic damage
- Damage caused by foreign objects, substances or accidents
- Accidental damage or modification
- Failure to follow manufacturer's guidelines
- Loss of use of the goods



Batteries and battery chargers are not covered under the Erbauer 3 Year Warranty and will have a guarantee period of 2 years from the date of purchase.

If the product is defective, we will, within a reasonable time, repair or replace it.

Rights under this guarantee are enforceable in the country in which you purchased this product. Guarantee related queries should be addressed to the store you purchased this product from.

The guarantee is in addition to and does not affect your statutory rights.



Declaration of conformity



(EN) EU DECLARATION OF CONFORMITY
 (FR) DÉCLARATION UE DE CONFORMITÉ
 (PL) DEKLARACJA ZGODNOŚCI UE
 (RO) DECLARAȚIA DE CONFORMITATE UE
 (ES) DECLARACIÓN UE DE CONFORMIDAD
 (PT) DECLARAÇÃO DE CONFORMIDADE UE

Product/ Produit/ Produkt/Produsul/Producto/Produto

- CORDLESS ANGLE DRILL/PERCEUSE D'ANGLE SANS FIL/AKUMULATOROWA WIERTARKA KAŹTOWA/MAȘINĂ DE GĂURIT UNGHILARĂ/TALADRO ANGULAR INALĂMBRICO/BERBEQUIM ANGULAR SEM FIO/KABLOSUZ AÇILI MATKAP
- EAD12-Li
- SN: 000001-999999

Name and address of the manufacturer or his authorised representative:

Nom et adresse du fabricant ou de son mandataire:

Nazwa i adres producenta lub jego upoważnionego przedstawiciela:

Denumirea și adresa producătorului sau a reprezentantului său autorizat:

Nombre y dirección del fabricante o de su representante autorizado:

Nome e endereço do fabricante ou do respetivo mandatário:

Kingfisher International Products B.V.,
 Rapenburgerstraat 175E,
 1011 VM Amsterdam,
 The Netherlands

This declaration of conformity is issued under the sole responsibility of the manufacturer.

La présente déclaration de conformité est établie sous la seule responsabilité du fabricant.

Niniejsza deklaracja zgodności wydana zostaje na wyłączną odpowiedzialność producenta.

Prezenta declarație de conformitate este emisă pe răspunderea exclusivă a producătorului.

La presente declaración de conformidad se expide bajo la exclusiva responsabilidad del fabricante.

A presente declaração de conformidade é emitida sob a exclusiva responsabilidade do fabricante.

Object of the declaration/Objet de la déclaration/Przedmiot deklaracji/Obiectul declarației/Objeto de la declaración/Objeto da declaração

Product/Produit/Produkt/Produsul/Producto/ Produto	Model/Modèle/Model/Modelul/Modelo/Modelo	EAN
CORDLESS ANGLE DRILL	EAD12-Li	5059340010670
PERCEUSE D'ANGLE SANS FIL		5059340043074
AKUMULATOROWA WIERTARKA KAŹTOWA		5059340043074
MAȘINĂ DE GĂURIT UNGHILARĂ		5059340043074
TALADRO ANGULAR INALĂMBRICO		5059340043074
BERBEQUIM ANGULAR SEM FIO		5059340043074

The object of the declaration described above is in conformity with the relevant Union harmonisation legislation:

L'objet de la déclaration décrit ci-dessus est conforme à la législation d'harmonisation de l'Union applicable:

Wymieniony powyżej przedmiot niniejszej deklaracji jest zgodny z odpowiednimi wymaganiami unijnego prawodawstwa harmonizacyjnego:

Obiectul declarației descris mai sus este în conformitate cu legislația relevantă de armonizare a Uniunii:

El objeto de la declaración descrita anteriormente es conforme con la legislación de armonización pertinente de la Unión:

O objeto da declaração acima descrito está em conformidade com a legislação de harmonização da União aplicável:

2006/42/EC as amended Machinery Directive
 2014/30/EU as amended Directive Electromagnetic compatibility
 2011/65/EU as amended Directive Restriction of the use of certain hazardous substances in electrical and electronic equipment

Directive 2006/42/CE relative aux machines

2014/30 / UE telle que modifiée Directive Compatibilité électromagnétique

Directive 2011/65/UE relative à la limitation de l'utilisation de certaines substances dangereuses dans les équipements électriques et électroniques

2006/42/WE w zmiennej dyrektywie maszynowej

2014/30 / UE ze zmianami Dyrektywa Kompatybilność elektromagnetyczna

2011/65 / UE ze zmianami Dyrektywa Ograniczenie stosowania niektórych niebezpiecznych substancji w sprzęcie elektrycznym i elektronicznym

2006/42/CE, astfel a fost modificată Directiva privind echipamentele

2014/30/UE, astfel a fost modificată Directiva privind compatibilitatea electromagnetica

2011/65/UE, astfel a fost modificată Directiva privind limitarea utilizării anumitor substanțe periculoase în echipamentele electrice și electronice

Directiva sobre maquinaria modificada 2006/42/CE
 2014/30/UE modificada Directiva Compatibilidad electromagnética
 2011/65/UE modificada Directiva Restricción del uso de determinadas sustancias peligrosas en equipos eléctricos y electrónicos

2006/42/CE como diretiva de máquinas alteradas
 2014/30/UE como alteração da compatibilidade eletromagnética
 2011/65/UE como restrição diretiva alterada da utilização de certas substâncias perigosas em equipamentos elétricos e eletrônicos

References to the relevant harmonised standards used or references to the other technical specifications in relation to which conformity is declared:

Références des normes harmonisées pertinentes appliquées, y compris la date de celles-ci, ou des autres spécifications techniques, y compris la date de celles-ci, par rapport auxquelles la conformité est déclarée:

Odwołania do odnośnych norm zharmonizowanych, które zastosowano, wraz z datą normy, lub do innych specyfikacji technicznych, wraz z datą specyfikacji, w odniesieniu do których deklarowana jest zgodność:

Trimeri la standardele armonizate relevante folosite, inclusiv data standardului, sau trimeri la celelalte specificații tehnice, inclusiv data specificațiilor, în legătură cu care se declară conformitatea:

Referencias a las normas armonizadas pertinentes utilizadas, incluidas las fechas de las normas, o referencias a las otras especificaciones técnicas, incluidas las fechas de las especificaciones, respecto a las cuales se declara la conformidad:

Referências às normas harmonizadas aplicáveis utilizadas, incluindo a data da norma, ou às outras especificações técnicas, incluindo a data da especificação, em relação às quais é declarada a conformidade:

EN 62841-1:2015
 EN 62841-2-1:2018+A11:2019
 EN 55014-1: 2017+A11: 2020
 EN IEC 55014-1:2021
 EN 55014-2: 2015
 EN IEC 55014-2:2021

Authorised signatory and technical file holder/Signataire et responsable de la documentation technique autorisé/ Podmiot uprawniony do wystawienia i adres przechowywania dokumentacji technicznej/Semnatar autorizat și deținător al dosarului tehnic/Firmante autorizado y titular del expediente técnico/ signatário autorizado e detentor da ficha técnica

Kingfisher International Products B.V.,
 Rapenburgerstraat 175E,
 1011 VM Amsterdam,
 The Netherlands

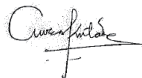

David Awe
 Group Quality Director

30/11/2021

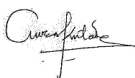

(UK) DECLARATION OF CONFORMITY

Product		
<ul style="list-style-type: none"> • CORDLESS ANGLE DRILL • EAD12-Li • Serial number: 000001-999999 		
Name and address of the manufacturer or his authorised representative:		
<p style="text-align: center;">Kingfisher International Products Limited 3 Sheldon Square London W2 6PX United Kingdom</p>		
This declaration of conformity is issued under the sole responsibility of the manufacturer.		
Object of the declaration		
Product	Model	EAN
CORDLESS ANGLE DRILL	EAD12-Li	5059340010670
The object of the declaration described above is in conformity with the relevant legislation:		
<p>Supply of Machinery (Safety) Regulations 2008 as amended Electromagnetic Compatibility Regulations 2016 as amended The Restriction of the use of Certain Hazardous Substances in Electrical and Electronic Equipment Regulations 2012 as amended</p>		
References to the relevant designated standards used or references to the other technical specifications in relation to which conformity is declared:		
<p>BS EN 62841-1:2015 BS EN 62841-2-1:2018+A11:2019 EN 62841-1:2015 EN 62841-2-1:2018+A11:2019 EN 55014-1:2017+A11:2020 EN IEC 55014-1:2021 EN 55014-2:2015 EN IEC 55014-2:2021 BS EN 55014-1: 2017+A11: 2020 BS EN IEC 55014-1:2021 BS EN 55014-2: 2015 BS EN IEC 55014-2:2021</p>		
Authorised signatory and technical file holder:		
<p>Kingfisher International Products Limited 3 Sheldon Square London W2 6PX United Kingdom</p>		
		
David Awe Group Quality Director		On:30/11/2021



Manufacturer • Fabricant • Producent • Producător • Fabricante:

UK manufacturer:

Kingfisher International Products Limited
3 Sheldon Square London W2 6PX
United Kingdom
www.kingfisher.com/products

EU manufacturer:

Kingfisher International Products B.V.
Rapenburgerstraat 175E
1011 VM Amsterdam
The Netherlands

www.diy.com | www.screwfix.com | www.screwfix.ie

To view instruction manuals online,
visit www.kingfisher.com/products

Customer Helpline:

UK 03301248111 erbauer@powertoolservicing.co.uk

Eire 0035312479977 erbauer@powertoolservicing.co.uk