

evolution®

evolutionpowertools.com

S210

CCS

058-0001, 058-0002, 058-0003, 058-0004

Original Instructions

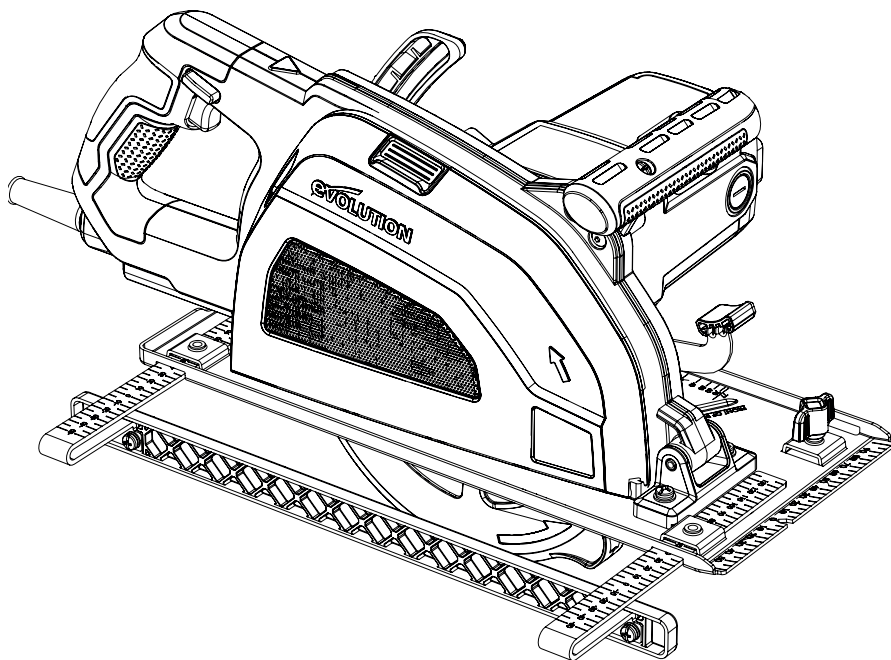

This Instruction Manual was originally written in English.

IMPORTANT

Please read these operating and safety instructions carefully and completely. For your own safety, if you are uncertain about any aspect of using this equipment please access the relevant Technical Helpline, the number of which can be found on the Evolution Power Tools website. We operate several Helplines throughout our worldwide organization, but Technical help is also available from your supplier.

**WEB: www.evolutionpowertools.com
UK/EU/AUS: customer.services@evolutionpowertools.com
USA: evolutioninfo@evolutionpowertools.com**

Congratulations on your purchase of an Evolution Power Tools Machine. Please complete your product registration 'online' as explained in the A4 online guarantee registration leaflet included with this machine. You can also scan the QR code found on the A4 leaflet with a Smart Phone. This will enable you to validate your machine's guarantee period via Evolutions website by entering your details and thus ensure prompt service if ever needed. We sincerely thank you for selecting a product from Evolution Power Tools.

EVOLUTION LIMITED GUARANTEE. Evolution Power Tools reserves the right to make improvements and modifications to the product design without prior notice.

Please refer to the guarantee registration leaflet and/or the packaging for details of the terms and conditions of the guarantee.

Evolution Power Tools will, within the guarantee period, and from the original date of purchase, repair or replace any goods found to be defective in materials or workmanship. This guarantee is void if the tool being returned has been used beyond the recommendations in the Instruction Manual or if the machine has been damaged by accident, neglect, or improper service. This guarantee does not apply to machines and / or components which have been altered, changed, or modified in any way, or subjected to use beyond recommended capacities and specifications. Electrical components are subject to respective manufacturers' warranties. All goods returned defective shall be returned prepaid freight to Evolution Power Tools. Evolution Power Tools reserves the right to optionally repair or replace it with the same or equivalent item. There is no warranty – written or verbal – for consumable accessories such as (following list not exhaustive) blades, cutters, drills, chisels or paddles etc. In no event shall Evolution Power Tools be liable for loss or damage resulting directly or indirectly from the use of our merchandise or from any other cause. Evolution Power Tools is not liable for any costs incurred on such goods or consequential damages. No officer, employee or agent of Evolution Power Tools is authorized to make oral representations of fitness or to waive any of the foregoing terms of sale and none shall be binding on Evolution Power Tools.

Questions relating to this limited guarantee should be directed to the company's head office, or call the appropriate Helpline number.

SPECIFICATIONS

MACHINE SPECIFICATIONS	UK/EU	USA
Motor UK/EU (220-240V ~ 50 Hz)	1800W	-
Motor UK (110V ~ 50 Hz)	1600W	-
Motor USA (120V ~ 60 Hz)	-	15A
No Load Speed (min ⁻¹ /rpm)	2800	
Gross weight	11.2kg	24.7lbs
Net weight	8.9kg	19.6lbs
Power cable length	3M	10ft

CUTTING CAPACITIES	UK/EU	USA
Max steel box section/pipe 90°	76.2mm	3"
Max Thickness (Plate)	13mm	0-1/2"
Max Wall Thickness	6mm	0-7/32"
Track cutting capacity	72mm	2-26/32"

BLADE SPECIFICATIONS	UK/EU	USA
Blade Diameter	210mm	8-1/4"
Max. Speed (min ⁻¹ /rpm)	3750	3750
Bore Diameter	25.4mm	1"
Kerf	2mm	5/64"
Teeth	50	

NOISE & VIBRATION DATA	
Sound pressure level L _{pA} (220-240V)	94.2dB
Sound power level L _{WA} (220-240V)	105.2dB
Vibration (220-240V)	a _h =2.84 (main handle) a _h =3.35(auxiliary handle)
Sound pressure level L _{pA} (110V)	92dB
Sound power level L _{WA} (110V)	103dB
Vibration (110V)	a _h =3.03(main handle) a _h =3.57(auxiliary handle)

WARNING: Due to the power input of this product on start up, voltage drops may occur and this can influence other equipment (e.g. dimming lights). So for technical reasons we advise, if the mains-impedance is $Z_{\text{sysmax}} < 0.2626 \Omega$, these disturbances are not expected. If you require further clarification, you may contact your local power supply authority.

VIBRATION

Note: The vibration measurement was made under standard conditions in accordance with: EN 62841-1: 2015, EN 62841-2-5: 2014

WARNING: WEAR HEARING PROTECTION!

The declared vibration total value has been measured in accordance with a standard test method and may be used for comparing one tool with another.

The declared vibration total value may also be used in a preliminary assessment of exposure.

 **WARNING:** When using this machine the operator can be exposed to high levels of vibration transmitted to the hand and arm.

It is possible that the operator could develop "Vibration white finger disease" (Raynaud syndrome). This condition can reduce the sensitivity of the hand to temperature as well as producing general numbness.

Prolonged or regular users of this machine should monitor the condition of their hands and fingers closely. If any of the symptoms become evident, seek immediate medical advice.

- The measurement and assessment of human exposure to hand-transmitted vibration in the workplace is given in: EN 62841-1 and EN 62841-2-5
- Many factors can influence the actual vibration level during operation e.g. the work surfaces condition and orientation and the type and condition of the machine being used. Before each use, such factors should be assessed, and where possible appropriate working practices adopted. Managing these factors can help reduce the effects of vibration:

Handling

- Handle the machine with care, allowing the machine to do the work.
- Avoid using excessive physical effort on any of the machines controls.
- Consider your security and stability, and the orientation of the machine during use.

Work Surface

- Consider the work surface material; its condition, density, strength, rigidity and orientation.





 **WARNING:** The vibration emission during actual use of the power tool can differ from the declared total value depending on the ways in which the tool is used.

The need to identify safety measures and to protect the operator are based on an estimation of exposure in the actual conditions of use (taking account of all parts of the operating cycle, such as the times the tool is switched off, when it is running idle, in addition to trigger time).

LABELS & SYMBOLS

WARNING: Do not operate this machine if warning and/or instruction labels are missing or damaged. Contact Evolution Power Tools for replacement labels.

Note: All or some of the following symbols may appear in the manual or on the product.

Symbol	Description
V	Volts
W	Watts
A	Amperes
Hz	Hertz
Min ⁻¹ /rpm	Speed
~	Alternating Current
n ₀	No Load Speed
Db	Decibel
awh	Time averaged weighted acceleration
ahm	Analytic Harmonic method
	Wear Safety Goggles
	Wear Ear Protection
	Wear Dust Protection
	Read Instructions
	Double Insulated
	CE Certification
	UKCA Certification
	TUV SUD GS Certification
	Waste Electrical & Electronic Equipment
	Triman - Waste Collection & Recycling
	Warning

INTENDED USE OF THIS POWER TOOL

 **WARNING:** This product is a Hand Operated Circular Saw and has been designed to be used with special Evolution blades. Only use accessories designed for use in this machine and/or those recommended specifically by Evolution Power Tools Ltd.

When fitted with an appropriate blade this machine can be used to cut:

Mild Steel
Thin Steel
Aluminium
Stainless Steel

Note: This product is not suitable for cutting wood.

Note: Cutting galvanised steel may reduce blade life.

PROHIBITED USE OF THIS POWER TOOL

WARNING: This product is a Hand Operated Circular Saw and must only be used as such. It must not be modified in any way, or used to power any other equipment or drive any other accessories other than those mentioned in this Instruction Manual.

 **WARNING:** This machine is not intended for use by persons (including children) with reduced physical, sensory or mental capabilities, or lack of experience and knowledge, unless they have been given supervision or instruction concerning the safe use of the machine by a person responsible for their safety and who is competent in its safe use.

Children should be supervised to ensure that they do not have access to, and are not allowed to play with, this machine.

ELECTRICAL SAFETY

This machine is fitted with the correct moulded plug and mains lead for the designated market. If the supply cord is damaged, it must be replaced by a special cord or assembly available from the manufacturers or its service agent.

(1.13) OUTDOOR USE

⚠ WARNING: For your protection if this tool is to be used outdoors it should not be exposed to rain, or used in damp locations. Do not place the tool on damp surfaces. Use a clean, dry workbench if available. For added protection use a residual current device (R.C.D.) that will interrupt the supply if the leakage current to earth exceeds 30mA for 30ms. Always check the operation of the residual current device (R.C.D.) before using the machine.

If an extension cable is required it must be a suitable type for use outdoors and so labelled. The manufacturers instructions should be followed when using an extension cable.

(2.1) GENERAL SAFETY INSTRUCTIONS

(These General Power Tool Safety Instructions are as specified in EN 62841-1: 2015, UL Std. 62841-1 and CSA Std. C22.2 No. 62841-1).

WARNING: Read all safety warnings and instructions. Failure to follow the warnings and instructions may result in electric shock, fire and/ or serious injury.

Save all warnings and instructions for future reference. The term “power tool” in the warnings refers to your mains-operated (corded) power tool or battery-operated (cordless) power tool.

(2.2) 1) General Power Tool Safety Warnings [Work area safety]

- a) Keep work area clean and well lit.** Cluttered or dark areas invite accidents.
- b) Do not operate power tools in explosive atmospheres, such as in the presence of flammable liquids, gases or dust.** Power tools create sparks which may ignite the dust or fumes.
- c) Keep children and bystanders away while operating power tool.** Distractions can cause you to lose control.

(2.3) 2) General Power Tool Safety Warnings [Electrical Safety]

- a) Power tool plugs must match the outlet. Never modify the plug in any way. Do not use any adapter plugs with earthed (grounded) power tools.** Unmodified plugs and matching outlets will reduce risk of

electric shock.

- b) Avoid body contact with earthed or grounded surfaces, such as pipes, radiators, ranges and refrigerators.** There is an increased risk of electric shock if your body is earthed or grounded.
- c) Do not expose power tools to rain or wet conditions.** Water entering a power tool will increase the risk of electric shock.
- d) Do not abuse the cord. Never use the cord for carrying, pulling or unplugging the power tool. Keep cord away from heat, oil, sharp edges or moving parts.** Damaged or entangled cords increase the risk of electric shock.
- e) When operating a power tool outdoors, use an extension cord suitable for outdoor use.** Use of a cord suitable for outdoor use reduces the risk of electric shock.
- f) If operating a power tool in a damp location is unavoidable, use a residual current device (RCD) protected supply.** Use of an RCD reduces the risk of electric shock.

(2.4) 3) General Power Tool Safety Warnings [Personal Safety].

- a) Stay alert, watch what you are doing and use common sense when operating a power tool.** Do not use a power tool while you are tired or under the influence of drugs, alcohol or medication. A moment of inattention while operating power tools may result in serious personal injury.
- b) Use personal protective equipment.** Always wear eye protection. Protective equipment such as dust masks, non-skid safety shoes, hard hat or hearing protection used for appropriate conditions will reduce personal injuries.
- c) Prevent unintentional starting.** Ensure the switch is in the off-position before connecting to power source and or battery pack, picking up or carrying the tool. Carrying power tools with your finger on the switch or energising the power tools that have the switch on invites accidents.
- d) Remove any adjusting key or wrench from blade bolt before turning the power tool on.** A wrench or key left attached to a rotating part of a power tool may result in personal injury.
- e) Do not overreach. Keep proper footing and balance at all times.** This enables better control of the power tool in unexpected situations.

f) Dress properly. Do not wear loose clothing or jewellery. Keep your hair, clothing and gloves away from moving parts. Loose clothes, jewellery or long hair can be caught in moving parts.

g) If devices are provided for the connection of dust extraction and collection facilities, ensure that these are connected and properly used. Use of dust collection can reduce dust-related hazards.

h) Do not let familiarity gained from frequent use of tools allow you to become complacent and ignore tool safety principles. A careless action can cause severe injury within a fraction of a second.

(2.5) 4) General Power Tool Safety Warnings [Power tool use and care].

a) Do not force the power tool. Use the correct power tool for your application. The correct power tool will do the job better and safer at a rate for which it was designed.

b) Do not use the power tool if the switch does not turn it on or off. Any power tool that cannot be controlled with the switch is dangerous and must be repaired.

c) Disconnect the power tool from the power source from the power tool before making any adjustments, changing accessories, or storing power tools. Such preventative safety measures reduce the risk of starting the power tool accidentally.

d) Store idle power tools out of the reach of children and do not allow persons unfamiliar with the power tool or these instructions to operate the power tool. Power tools are dangerous in the hands of untrained users.

e) Maintain power tools. Check for misalignment or binding of moving parts, breakage of moving parts and any other condition that may affect the power tools operation. If damaged, have the power tool repaired before use. Many accidents are caused by poorly maintained power tools.

f) Keep cutting tools sharp and clean. Properly maintained cutting tools with sharp cutting edges are less likely to bind and are easier to control.

g) Use the power tool, accessories and tool bits etc. in accordance with these instructions, taking into account the working conditions and the work to be performed. Use of the power tool for operations different from those intended

could result in a hazardous situation.

h) Keep handles and grasping surfaces dry, clean and free from oil and grease. Slippery handles and grasping surfaces do not allow for safe handling and control of the tool in unexpected situations.

(2.6) 5) General Power Tool Safety Warnings [Service]

a) Have your power tool serviced by a qualified repair person using only identical replacement parts. This will ensure that the safety of the power tool is maintained.

HEALTH ADVICE

WARNING: When using this machine, dust particles may be produced. In some instances, depending on the materials you are working with, this dust can be particularly harmful. If you suspect that paint on the surface of material you wish to cut contains lead, seek professional advice. Lead based paints should only be removed by a professional and you should not attempt to remove it yourself.

Once the dust has been deposited on surfaces, hand to mouth contact can result in the ingestion of lead. Exposure to even low levels of lead can cause irreversible brain and nervous system damage. The young and unborn children are particularly vulnerable. You are advised to consider the risks associated with the materials you are working with and to reduce the risk of exposure.

As some materials can produce dust that may be hazardous to your health, we recommend the use of an approved face mask with replaceable filters when using this machine.

You should always:

- Work in a well-ventilated area.
- Work with approved safety equipment, such as dust masks that are specially designed to filter microscopic particles.

WARNING: the operation of any power tool can result in foreign objects being thrown towards your eyes, which could result in severe eye damage. Before beginning power tool operation, always wear safety goggles or safety glasses with side shield or a full face shield where necessary.

SAFETY INSTRUCTIONS FOR ALL SAWS

[Cutting procedures]

a) DANGER: Keep hands away from cutting area and the blade. Keep your second hand on auxiliary handle, or motor housing. If both hands are holding the saw, they cannot be cut by the blade.

b) Do not reach underneath the workpiece. The guard cannot protect you from the blade below the workpiece.

c) Adjust the cutting depth to the thickness of the workpiece. Less than a full tooth of the blade teeth should be visible below the workpiece.

d) Never hold the workpiece in your hands or across your leg while cutting. Secure the workpiece to a stable platform. It is important to support the work properly to minimise body exposure, blade binding, or loss of control.

e) Hold the power tool by insulated gripping surfaces, when performing an operation where the cutting tool may contact hidden wiring or its own cord. Contact with a "live" wire will also make exposed metal parts of the power tool "live" and could give the operator an electric shock.

f) When ripping, always use a rip fence or straight edge guide. This improves the accuracy of cut and reduces the chance of blade binding.

g) Always use blades with correct size and shape (diamond versus round) of arbour holes. Blades that do not match the mounting hardware of the saw will run off-centre, causing loss of control.

h) Never use damaged or incorrect blade washers or bolt. The blade washers and bolt were specially designed for your saw, for optimum performance and safety of operation.

(3.2) [Kickback causes and related warnings]

Kickback is a sudden reaction to a pinched, jammed or misaligned saw blade, causing an uncontrolled saw to lift up and out of the workpiece toward the operator; When the blade is pinched or jammed tightly by the kerf closing down, the blade stalls and the motor reaction drives the unit rapidly back toward the operator;

If the blade becomes twisted or misaligned in the cut, the teeth at the back edge of the blade can dig into the top surface of the workpiece causing the blade to climb out of the kerf and jump back toward the operator.

(3.3) Kickback is the result of saw misuse and/or incorrect operating procedures or conditions and can be avoided by taking proper precautions as given below.

a) Maintain a firm grip with both hands on the saw and position your arms to resist kickback forces. Position your body to either side of the blade, but not in line with the blade. Kickback could cause the saw to jump backwards, but kickback forces can be controlled by the operator, if proper precautions are taken.

b) When blade is binding, or when interrupting a cut for any reason, release the trigger and hold the saw motionless in the material until the blade comes to a complete stop. Never attempt to remove the saw from the work or pull the saw backward while the blade is in motion or kickback may occur. Investigate and take corrective actions to eliminate the cause of blade binding.

c) When restarting a saw in the workpiece, centre the saw blade in the kerf so that the saw teeth are not engaged into the material. If a saw blade binds, it may walk up or kickback from the workpiece as the saw is restarted.

d) Do not use dull or damaged blades. Unsharpened or improperly set blades produce narrow kerf causing excessive friction, blade binding and kickback.

e) Blade depth and bevel adjusting locking levers must be tight and secure before making a cut. If the blade adjustment shifts while cutting it may cause binding and kickback.

f) Blade depth and bevel adjusting locking levers must be tight and secure before making the cut. If blade adjustment shifts while cutting, it may cause binding and kickback.

g) Use extra caution when sawing into existing walls or other blind areas. The protruding blade may cut objects that can cause kickback.

LOWER GUARD FUNCTION

a) Check the lower guard for proper closing before each use. Do not operate the saw if the lower guard does not move freely and close instantly. Never clamp or tie the lower guard into the open position. If the saw is accidentally dropped, the lower guard may be bent. Raise the lower guard with the retracting handle and make sure it moves freely and does not touch the blade or any other part, in all

angles and depths of cut.

b) Check the operation of the lower guard spring. If the guard and the spring are not operating properly, they must be serviced before use. Lower guard may operate sluggishly due to damaged parts, gummy deposits, or a build-up of debris.

c) Always observe that the lower guard is covering the blade before placing the saw down on bench or floor. An unprotected, coasting blade will cause the saw to walk backwards, cutting whatever is in its path. Be aware of the time it takes for the blade to stop after switch is released.

ADDITIONAL SAFETY INSTRUCTIONS FOR CIRCULAR SAWS

a) Do not use High Speed Steel (HSS) saw blades.

b) Inspect the machine and the blade before each use. Do not use deformed, cracked, worn or otherwise damaged blades.

c) Never use the saw without the original guard protection system. Do not lock the moving guard in the open position. Ensure that the guard operates freely without jamming.

d) Only use blades that comply with the characteristics specified in this manual. Before using accessories, always compare the maximum allowed RPM of the accessory with the RPM of the machine.

e) Do not use any abrasive wheels.

f) Use only blade diameter(s) in accordance with the markings.



WARNING: If any parts are missing, do not operate your machine until the missing parts are replaced. Failure to follow this rule could result in serious personal injury.

(4.1) GETTING STARTED - UNPACKING

Caution: This packaging contains sharp objects. Take care when unpacking. Remove the machine, together with the accessories supplied from the packaging. Check carefully to ensure that the machine is in good condition and account for all the accessories listed in this manual. Also make sure that all the accessories are complete.

If any parts are found to be missing, the machine and its accessories should be returned together in their original packaging to the retailer.

Do not throw the packaging away; keep it safe throughout the warranty period. Dispose of the packaging in an environmentally responsible manner. Recycle if possible. Do not let children play with empty plastic bags due to the risk of suffocation.

(4.2) ITEMS SUPPLIED

Description	CCS
S210CCS	1
210mm Mild steel blade	1
Instruction Manual	1
Hex Key (Blade Change)	1
Full length parallel edge guide	1

Evolution Instruction Manuals

Evolution Power Tools provides each product with an Instruction Manual. Each dedicated manual is carefully constructed and designed to provide easily accessible and useful information regarding the safe use, care and maintenance of the product. Referencing the information contained within the manual will allow the operator to fully and safely exploit the potential of the machine. Evolutions policy of continual product development may mean that, very occasionally, the contents of a manual may not completely reflect the latest improvements or upgrades that have been incorporated into a particular product. Upgrades/improvements to the specification of a product could come about as a consequence of technological advances or changes to the legislative framework of the receiving country, etc. If you are at all unsure about any aspect of the use, care or maintenance of an Evolution product, contact the relevant Evolution helpline where up to date information and extra advice will be available.

MACHINE OVERVIEW

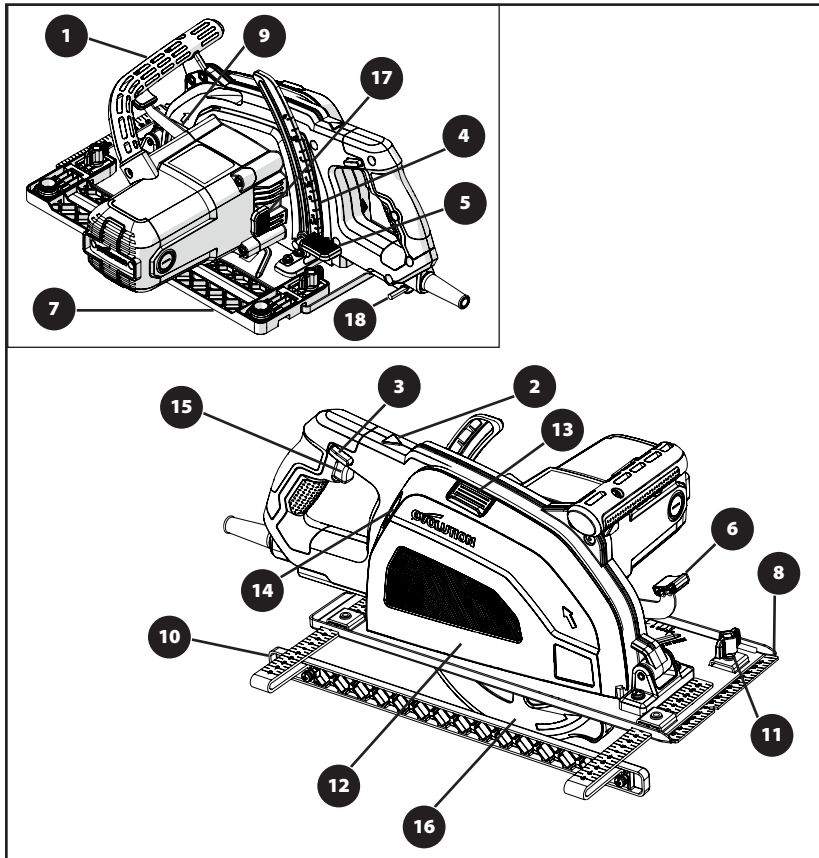

- | | |
|---|-----------------------------------|
| 1. Ambidextrous Bale Handle | 11. Parallel guide thumb screws |
| 2. Overload warning light | 12. Detachable chip collector |
| 3. Ambidextrous lock off | 13. Chip collector release button |
| 4. Depth gauge | 14. Chip collector viewing window |
| 5. Depth gauge lever | 15. Operating trigger |
| 6. Blade guard retraction lever | 16. Lower blade guard |
| 7. Track adapter (option supplied separately) | 17. Arbour lock button |
| 8. Base plate scale | 18. On board tool storage |
| 9. Blade viewing window | |
| 10. Parallel edge guide | |

*Numbers referred to throughout manual

PREPARATION

WARNING: Always disconnect the machine from the power source before making any adjustments.

Note: These machines are equipped with an approved power cord and plug for the intended country of use. Do not alter or modify the power cord.

INSTALLING/REMOVING A BLADE

WARNING: Use only genuine Evolution blades which are designed for use in these machines. Ensure that the maximum speed of the blade is compatible with the machine. Only perform this operation with the machine disconnected from the power supply.

Note: It is recommended that the operator considers wearing protective gloves when handling the blade during installation or when changing the machines blade. The recommended Evolution blades are shown in the table below.

Blade codes	Cutting blades
M210TCT-50CS	Mild Steel
T210TCT-68CS	Thin Steel
S210TCT-54CS	Stainless Steel
A210TCT-60CS	Aluminium

Refer to the website for more information on the capabilities and specification of Evolution blades.

- Locate the supplied Blade Change Hex Key, which is housed in the onboard storage facility **(18)** **(Fig.1)**
- Place saw securely on a level, secure surface.

Note: All machines can, with care, be rested on the flat end of the motor housing casing, **(Fig. 2)**, easing access to the blade and fixings.

- Remove the chip collector, **(12)**, by depressing the release button, **(13)** **(Fig.3)**, exposing the blade bolt, **(Fig.4)**.
- Engage the arbor lock button **(17)** and loosen the blade bolt using the supplied hex key. The blade bolt is equipped with a standard screw thread (turn the counter clockwise to loosen).
- Remove and safely store the blade bolt and outer flange. **(Fig.5)**
- Rotate the lower blade guard **(16)** then remove blade.

Note: The inner blade flange can be left in place if desired, but it should be checked and thoroughly cleaned. If it is removed from the machine it must be replaced back in the same orientation as it was before removal.

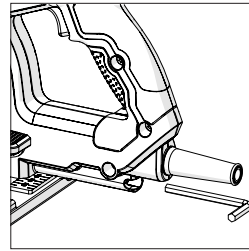

Fig. 1

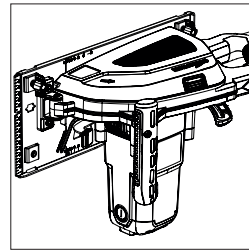

Fig. 2

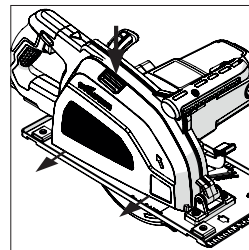

Fig. 3

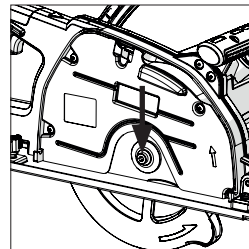

Fig. 4

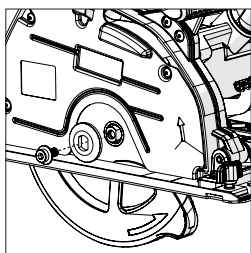

Fig. 5

- Thoroughly clean the blade around the bore area (both surfaces) where the blade flanges will touch and clamp the blade.
- Install the (new) blade. Ensure that the direction of rotation arrows printed on the blade, match the direction of rotation arrows found on the machines upper and lower blade guards. **(Fig.6).**
- Allow the lower blade guard to return to its closed position.
- Reinstall the outer flange and the blade bolt.

Note: The outer flange has a specially machined bore which incorporates two opposed 'flats,' **(Fig. 7)**, These 'flats' engage with two complimentary 'flats' machined on the arbor shaft.

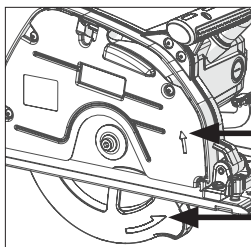

Fig. 6

- Re-engage the arbor lock button and tighten the blade bolt securely, using the Hex Key.
- Release the arbor lock button.
- Return the Hex Key to its dedicated on board storage position.
- Check that the arbor lock button has fully released by manually rotating the blade.
- Check the operation of the lower blade guard.
- Replace the chip collector.

Note: The inner flange is dual sided to suit 15.875mm (5/8") and 25.4mm (1") blade bore sizes.

Note: Ensure that the inner flange remains in place when removing outer flange for the first time.

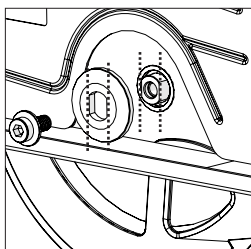

Fig. 7

PARALLEL EDGE GUIDE

A removable Parallel Edge Guide, **(10)** which can be particularly helpful for accuracy when rip cutting **(Fig.8)**, is supplied with this machine.

The guide arms should be inserted through the rectangular slots positioned at either side of the base plate, **(Fig.9)**, and slid under the forward and back adjustment locking thumb screws, **(11)**.

Adjust the edge guide so that it is at the required distance from the blade and tighten the adjusting screw. Check that the edge guide is parallel to the saw blade.

Note: The Parallel Edge Guide can be fitted on either side of the base plate.

WARNING: Only fit and adjust the Guide with the machine disconnected from the power supply.

Note: The arms of the Parallel Edge Guide must pass through all of the rectangular slots provided in the base plate.

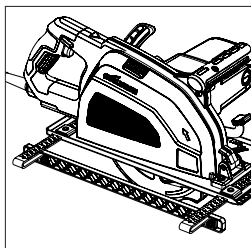

Fig. 8

⚠ WARNING: It is potentially dangerous to install, and try to use the Edge Guide with the arm passing through only one (1) of the machined rectangular base plate slots.

CUTTING DEPTH ADJUSTMENT

- Loosen the Depth Adjustment Locking Mechanism by pulling the operating lever, **(5)**(**Fig.10**), upwards.
- Adjust/re-position the base plate relative to the saw body by rotating about pivot, to give the required cutting depth (the amount by which the blade protrudes through the base plate).

Note: A depth gauge is attached to the base plate. Alignment of the operating lever, **(5)**, with the corresponding required depth, (**Fig.11**), can aid rapid setting.

Tighten the Depth Adjustment Locking Mechanism by pushing the operating lever, downwards to securely lock in the machine in the required position.

As the cutting depth is altered the position of the front of the blade relative to the base plate will vary. As an aid to cutting the base plate is fitted with a scale, **(8)** (**Fig.12**), on which the position of the front of the blade can be seen. This will be in line with the reading that corresponds to cutting depth shown on the depth gauge.

Note: Although this method is useful for rapid depth setting, it should always be regarded as a guide to the setting achieved. If a very precise depth of cut is required, then the blade setting should be checked with an engineer's precision ruler (not supplied) or similar and adjusted accordingly.

- In most cases the cutting depth should be set at the thickness of the material to be cut, plus approximately 3mm.
- Tighten the Depth Adjustment Locking Mechanism by pushing the operating lever, downwards to securely lock in the machine in the required position.

OPERATING ADVICE (PRE OPERATION CHECKS)

Note: As all operating environments will be unique and diverse, Evolution Power Tools offers the following general advice on safe operational procedures and practices for the consideration of the operator.

This advice cannot be exhaustive as Evolution has no influence on the type of workshops or working environments in which these machines may be used. We recommend that the operator seeks advice from a competent authority or the workshop supervisor if they are unsure of any aspect of using these machines. It is important that routine safety checks are

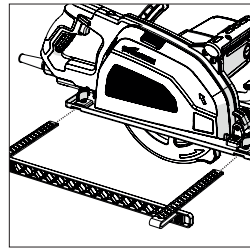

Fig. 9

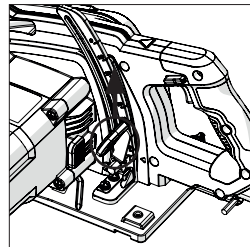

Fig. 10

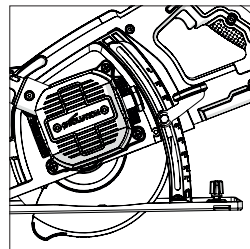

Fig. 11

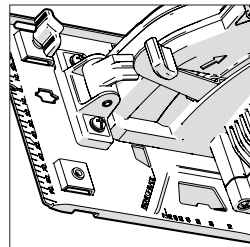

Fig. 12

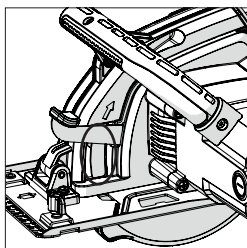

Fig. 13

carried out (at each time of usage) before the operator uses the machine.

⚠ WARNING: These pre-use safety checks should be carried out with the machine disconnected from the mains power supply.

- Check that all safety guards are operating correctly, and that all adjustment handles/screws are securely tightened.
- Check that the blade is secure and installed correctly. Also check that it is the correct blade for the material being cut.
- Check the integrity of the power cord.
- Whenever possible clamp the workpiece to a rigid support structure such as a workbench, saw horse or similar.
- The operator should always be aware of the position and routing of the power cable.

PERSONAL PROTECTIVE EQUIPMENT

The operator should wear all relevant PPE (Personal Protection Equipment) necessary for the task ahead. This could include safety glasses, full face mask, dust masks, safety shoes etc.

The Upper Blade Guard, is specially shaped to deflect most of the cut debris downwards and away from the operator into the detachable chip collector. Such debris may be hot and/or sharp. The operator should employ due care when clearing such material from the workpiece after a cut has been completed.

Note: Depending upon the material being cut some debris may also lodge inside the blade guard. Any such material should be removed during routine machine maintenance or during a blade change. Dispose of any collected debris in an environmentally responsible way.

THE BLADE VIEWING WINDOW

A toughened glass blade viewing window, (9), is located to the front left hand side of the upper blade guard near where the blade will emerge from a cut. (Fig.13), This allows the operator to monitor the progress of a cut, whilst providing protection from any ejected material.

Note: This glass window should be cleaned as required to ensure a clear and unobstructed view of the cut line.

⚠ WARNING: Any dust and debris created is potentially harmful to health. Some materials can be particularly harmful, and the operator should always wear a dust mask which is suitable for the material being worked with. Professional help and advice should be sought if the operator is at all unsure about the potential toxicity of the material to be cut.

⚠ WARNING: These machines must never be used to cut Asbestos or any material that contains, or is suspected to contain, Asbestos. Consult/inform the relevant authorities, and seek additional guidance if Asbestos contamination is suspected.

SWITCHING ON/OFF

This machine is equipped with a safety start trigger switch. To start the machine:

- Push in the safety lock button, **(3)**, on either side of the handle with your thumb.
- Depress the main trigger switch, **(15)**, to start the motor.

To stop the motor:

- Release the trigger switch.

⚠ WARNING: The motor should never be started with the saw blade in direct contact with any surface of the workpiece.

CHIP COLLECTOR

This machine is fitted with a detachable Chip Collector, **(12)** to capture metal chips. It is provided with a transparent 'window', **(14)**, so that the operator can see the contents and empty.

Note: When chips reach the arrow, this is an indication that the chip compartment is almost full.

To remove and empty the Chip Collector, depress the release button and pull away from the machine, **(13)**. Empty the contents of the chip collector by sliding the door up, **(Fig. 14a)**, and tipping the contents out over a suitable waste container and disposing in an environmentally responsible manner.

To replace the chip collector, the clips on the collector, **(Fig. 14b)**, must be inserted behind the hinges, prior to pressing the collector into place.

⚠ WARNING: The Chip Collector is very efficient and must be checked and emptied at regular intervals. When cutting steel the Chip Collector can become hot and care must be taken when handling.

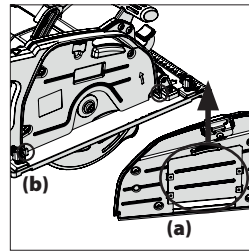

Fig. 14

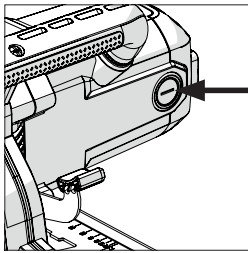

Fig. 15

LED BLADE GUIDE LINE

This machine is fitted with a LED light in the upper guard. This casts a shadow of the blade onto the workpiece. This provides the user with a clear cut line, and the LED illuminates the cutting area. This feature requires no user alignment.

ELECTRONIC BRAKE

This machine is fitted with an electronic brake integral to the motor housing. This slows the blade in a couple of seconds instead of allowing the blade to continue spinning until it comes to a natural stop.

ADVANCED OVERLOAD SYSTEM

There is an overload warning light, (2), on the top of the handle, which illuminates green when connected to the power supply and used under normal cutting conditions. The LED will illuminate red as a warning when the motor is at risk of overheating. If the overload warning lamp illuminates red, stop cutting and allow to cool down until the overload LED returns to green. Continuing to use the tool after the LED is illuminated red could cause irreparable damage.

CHECKING AND REPLACING THE CARBON BRUSHES



WARNING: Disconnect the machine from the power supply before attempting to check or replace the Carbon Brushes.

To remove the brushes:

Using a screw driver unscrew the plastic caps found at the back of the motor housing, (Fig.15). Be careful as the caps are spring-loaded. Withdraw the brushes with their springs.

Replace both carbon brushes if either has less than 6mm length of carbon remaining, or if the spring or wire is damaged or burned. Only replace with similar brushes and replace the caps. Run the machines motor without load for approximately 5 minutes. This will help the new brushes to 'bed-in' and ensure that the motor runs efficiently.

Note: Used but serviceable brushes can be replaced. These must be returned to their original service position. They must also be inserted the same way round as found prior to their removal from the machine.

TRACK ADAPTOR ASSEMBLY

An attachable track adaptor is available to purchase separately from Evolution. This device enables effortless straight line cutting when used in conjunction with a separately available track.

The track adaptor is fitted to the base plate under the motor. To fit the adaptor, hook the adaptor arms over the base plate edge ensuring the base plate return sits in the channels on the underside of the adaptor. Ensure the track adaptor arms are located over the base plate saddles. Secure the adaptor to the base plate using the provided wing nuts. **(Fig.16)**

The track adaptor should only be fitted and removed when the head is in the up position on the depth lock. It has two cams which project into the base plate channel (one at each end). 'Turn-buttons' allow the operator to rotate these cams. **(Fig. 17)**

The operator should adjust these cams so that when the machine is placed correctly on a track it can be moved forwards or backwards easily and smoothly but without any lateral movement (wobble) being detectable.

CUTTING ADVICE



WARNING: The operator must always be aware of the position and routing of the power cable. The cable must be routed in such a way that there is no possibility of the blade coming into contact with the mains cable.

- Do not force the machine. The overload warning (light will illuminate red).
- Allow the speed of the saw blade to do the work. Cutting performance will not be improved by applying excessive pressure to the machine and blade life will be reduced.
- Place front edge of base plate squarely on the workpiece. Before starting the motor ensure that the blade is not in contact with the workpiece.
- When starting a cut, align the cut-outs on the base plate to the required cut line on the workpiece or alternatively using the viewing window align the projected shadow of the blade to the required cut line on the workpiece, taking care to introduce the blade to the material slowly so as not to damage blade teeth.
- Use both hands to move the saw forwards through the workpiece.
- Apply smooth, constant pressure to move the saw forwards through the workpiece.

Note: All Evolution Steel Cutting machines have an automatic lower blade guard **(16)** which has a specially shaped leading front edge. This feature ensures that the blade guard retracts smoothly and effortlessly as the machines blade enters the workpiece. As the blade exits the workpiece the lower blade guard will automatically return to its normal position covering the blade completely.

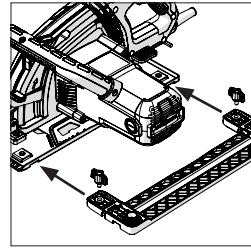

Fig. 16

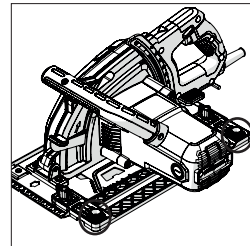

Fig. 17

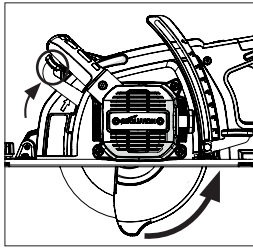

Fig. 18

Note: The lower blade guard is designed to be pushed (rotated) out of the way at the start of a cut by lifting the blade guard retraction lever (6) to start this rotation may help when cutting certain materials. **(Fig.18)**

When a cut has been completed:

- Release the ON/OFF Trigger switch.
- Allow the blade to come to a complete stop.
- Remove the machine from the workpiece allowing the lower blade guard to return to its normal position covering the blade.

GENERAL MAINTENANCE & CLEANING

Note: All maintenance must be carried out with the machine switched off and disconnected from the power supply.

- Check that all safety features and guards are operating correctly on a regular basis. Only use this machine if all guards/safety features are fully operational.
- All motor bearings in these machines are lubricated for life. No further lubrication is required.
- Use a clean, slightly damp cloth to clean the plastic parts of the machine. Do not use solvents or similar products which could damage the plastic parts.

WARNING: Do not attempt to clean by inserting pointed objects through openings in the machine's casings etc. The machines air vents should be cleaned using compressed dry air.

Note: The operator should employ all necessary PPE when using compressed dry air as a cleaning medium.

GLASS VIEWING WINDOW

Clean the viewing window as required using a damp cloth or a proprietary glass cleaning medium. Do not use any abrasive materials as these may damage or scratch the glass.

DEBRIS BUILD-UP (UPPER BLADE GUARD)

During a blade change the opportunity to check for any debris build up within the upper blade guard should be taken. Any such debris found should be removed using a suitable tool (possibly plastic or wooden) which will remove the debris without damaging the interior of the blade guard.

WARNING: Suitable PPE should be worn by the operator when carrying out this task. Any removed debris must be disposed of in a safe and environmentally responsible way.



ENVIRONMENTAL PROTECTION

Waste electrical products should not be disposed of with household waste. Please recycle where facilities exist. Check with your Local Authority or retailer for recycling advice.

EC DECLARATION OF CONFORMITY



The manufacturer of the product covered by this Declaration is:

UK: Evolution Power Tools Ltd. Venture One, Longacre Close, Holbrook Industrial Estate, Sheffield, S20 3FR.

FR: Evolution Power Tools SAS. 61 Avenue Lafontaine, 33560, Carbon-Blanc, Bordeaux, France.

The manufacturer hereby declares that the machine as detailed in this declaration fulfils all the relevant provisions of the Machinery Directive and other appropriate directives as detailed below. The manufacture further declares that the machine as detailed in this declaration, where applicable, fulfils the relevant provisions of the Essential Health and Safety requirements.

The Directives covered by this Declaration are as detailed below:

2006/42/EC.	Machinery Directive.
2014/30/EU.	Electromagnetic Compatibility Directive.
2011/65/EU. & 2015/863/EU.	The Restriction of the Use of certain Hazardous Substances in Electrical Equipment (RoHS) Directive.
2012/19/EU.	The Waste Electrical and Electronic Equipment (WEEE) Directive.

And is in conformity with the applicable requirements of the following documents:

EN 62841-1:2015 • EN 62841-2-5:2014 • EN 55014-1:2017+A11:2020 • EN 55014-2:2015 • EN IEC 61000-3-2:2019 • EN 61000-3-11:2000

Product Details

Description:	S210CCS STEEL CUTTING CIRCULAR SAW
Evolution Model No:	058-0001, 058-0002, 058-0003
Brand Name:	EVOLUTION
Voltage:	110V / 220-240V ~ 50Hz 220-240V ~ 50 Hz
Input:	220-240V - 1800w 110V - 1600w

The technical documentation required to demonstrate that the product meets the requirements of directive has been compiled and is available for inspection by the relevant enforcement authorities, and verifies that our technical file contains the documents listed above and that they are the correct standards for the product as detailed above.

Name and address of technical documentation holder.

Signed:  Print: Barry Bloomer - CEO
Date: 26/03/21

EC DECLARATION OF CONFORMITY**UK
CA****The manufacturer of the product covered by this Declaration is:****UK:** Evolution Power Tools Ltd. Venture One, Longacre Close, Holbrook Industrial Estate, Sheffield, S20 3FR.**FR:** Evolution Power Tools SAS. 61 Avenue Lafontaine, 33560, Carbon-Blanc, Bordeaux, France.

The manufacturer hereby declares that the machine as detailed in this declaration fulfils all the relevant provisions of the Machinery Directive and other appropriate directives as detailed below. The manufacture further declares that the machine as detailed in this declaration, where applicable, fulfils the relevant provisions of the Essential Health and Safety requirements.

The Directives covered by this Declaration are as detailed below:

UK legislation_ Supply of Machinery (Safety) Regulations 2008
UK legislation_ Electromagnetic Compatibility Regulations 2016
UK legislation_ The Restriction of the Use of Certain Hazardous Substances in Electrical and Electronic Equipment Regulations 2012
UK regulation_ The Waste Electrical and Electronic Equipment Regulations 2013

And is in conformity with the applicable requirements of the following documents:

BS EN 62841-1:2015 • BS EN 62841-2-5:2014 • BS EN 55014-1:2017+A11:2020 •
BS EN 55014-2:2015 • BS EN IEC 61000-3-2:2019 • BS EN 61000-3-11:2000 •
EN 55014-1:2017+A11:2020 • EN 55014-2:2015 • EN IEC 61000-3-2:2019 • EN 61000-3-11:2000

Product Details

Description: S210CCS STEEL CUTTING CIRCULAR SAW
Evolution Model No: 058-0001, 058-0002, 058-0003
Brand Name: EVOLUTION
Voltage: 110V / 220-240V ~ 50Hz
220-240V ~ 50 Hz
Input: 220-240V - 1800w
110V - 1600w

The technical documentation required to demonstrate that the product meets the requirements of directive has been compiled and is available for inspection by the relevant enforcement authorities, and verifies that our technical file contains the documents listed above and that they are the correct standards for the product as detailed above.

Name and address of technical documentation holder.

Signed:  Print: Barry Bloomer - CEO
Date: 09/06/21

evOLUTION®

www.evolutionpowertools.com

US

Evolution Power Tools LLC
8363 Research Drive
Davenport, IA
52806

T: 866-EVO-TOOL

EU

Evolution Power Tools SAS
61 Avenue Lafontaine
33560
Carbon-Blanc
Bordeaux

T: +33 (0)5 57 30 61 89

UK

Evolution Power Tools Ltd
Venture One, Longacre Close
Holbrook Industrial Estate
Sheffield
S20 3FR

T: 0114 251 1022

AUS

Total Tools (Importing) Pty Ltd
20 Thackray Road
Port Melbourne
Vic 3207

T: 03 9261 1900



EPT QR CODE