

Robert Bosch Power Tools GmbH
70538 Stuttgart
GERMANY

www.bosch-garden.de

F 016 L81 434 (2014.10) O / 12 XXX



Rotak

32-12



en Original instructions



2 | English

English

Safety Notes

Warning! Read these instructions carefully, be familiar with the controls and the proper use of the machine. Please keep the instructions safe for later use!

Explanation of symbols



General hazard safety alert.



Read instruction manual.



Pay attention that bystanders are not injured through foreign objects thrown from the machine.



Warning: Keep a safe distance from the machine when operating.



Caution: Do not touch rotating blades. Sharp blade(s). Beware of severing toes or fingers.



Switch off and remove plug from mains before adjusting, cleaning or if the cable is entangled and before leaving the garden product unattended for any period. Keep the supply flexible cord away from the cutting blades.



Not applicable.



Wait until all machine components have completely stopped before touching them. The blades continue to rotate after the machine is switched off, a rotating blade can cause injury.



Do not use the machine in the rain or leave it outdoors when it is raining.



Beware electric shock hazard.



Keep supply flexible cord away from cutting means.

Operation

- ▶ Never allow children or people unfamiliar with these instructions to use the machine. Local regulations may restrict the age of the operator. When not in use store the machine out of reach of children.
- ▶ This machine is not intended for use by persons (including children) with reduced physical, sensory or mental capabilities, or lack of experience and knowledge, unless they have been given supervision or instruction concerning use of the machine by a person responsible for their safety. Children should be supervised to ensure that they do not play with the machine.
- ▶ Never mow while people, especially children, or pets are nearby.
- ▶ The operator or user is responsible for accidents or hazards occurring to other people or their property.
- ▶ Do not operate the machine when barefoot or wearing open sandals, always wear substantial footwear and long trousers.
- ▶ Thoroughly inspect the area where the machine is to be used and remove all stones, sticks, wires, bones and other foreign objects.

- ▶ Before using, always visually inspect to see that the blades, blade bolts and cutter assembly are not worn or damaged. Replace worn or damaged blades and bolts in sets to preserve balance.
 - ▶ Mow only in daylight or in good artificial light.
 - ▶ Avoid mowing in bad weather conditions especially when there is a risk of lightning.
 - ▶ Avoid operating the machine in wet grass, where feasible.
 - ▶ Walk, never run.
 - ▶ Never operate the appliance with defective guards or shields, or without safety devices, for example deflectors and/or grass catchers in place.
 - ▶ Always wear ear protection.
 - ▶ Working on banks can be dangerous.
 - Do not mow on excessively steep slopes.
 - Always be sure of your footing on slopes or wet grass.
 - Mow across the face of slopes – never up and down.
 - Exercise extreme caution when changing direction on slopes.
 - ▶ Use extreme caution when stepping back or pulling the machine towards you.
 - ▶ Never mow by pulling the mower towards you.
 - ▶ Stop the blades if the machine has to be tilted for transportation when crossing surfaces other than grass and when transporting the machine to and from the area to be mowed.
 - ▶ Do not tilt the machine when starting or switching on the motor, except if the machine has to be tilted for starting in long grass. In this case, do not tilt it more than absolutely necessary and tilt only the part which is away from the operator. Always ensure that both hands are in the operating position before returning the machine to the ground.
 - ▶ Switch on the motor according to the instructions with feet well away from rotating parts.
 - ▶ Do not put hands or feet near or under rotating parts.
 - ▶ Always stand clear of the discharge zone when operating the machine.
 - ▶ Never pick up or carry the machine while the motor is running.
 - ▶ **Keep supply cables and extension cables away from the blade.** The blade can cause damage to the cables and lead to contact with live parts. Beware electric shock hazard.
 - ▶ **Do not modify this product.** Unauthorized modifications may impair the safety of your product and may result in increased noise and vibration.
 - ▶ Regularly inspect the supply cable and any extension cables. Do not connect damaged cables to the supply or touch a damaged cable before it is disconnected from the supply. A damaged cable can lead to contact with live parts. Beware electric shock hazard.
- Remove the plug from the socket:**
- Whenever you leave the machine.
 - Before clearing a blockage,
 - Before checking, cleaning or working on the machine,

4 | English

- After striking a foreign object. Inspect the machine for damage and make repairs as necessary,
- If the machine starts to vibrate abnormally (check immediately).

Power supply

- ▶ The voltage indicated on the rating plate must correspond to the voltage of the power source.
- ▶ We recommend that this equipment is only connected into a socket which is protected by a circuit-breaker that would be actuated by a 30 mA residual current.
- ▶ Only use or replace power supply cables for this unit which correspond to the types indicated by the manufacturer. See the operating instructions for the order no. and types.
- ▶ Never touch the mains plug with wet hands.
- ▶ Do not run over, crush or pull the power supply cable or extension lead, otherwise it may be damaged. Protect the cable from heat, oil and sharp edges.
- ▶ The extension lead must have a cross section in accordance with the operating instructions and be protected against splashed water. The connection must not be in water.

Electrical Safety

- ▶ **Warning! Switch off, remove plug from mains before adjusting, cleaning or if cable is cut, damaged or entangled.**
- ▶ **The blades continue to rotate for a few seconds after the machine is switched off.**

▶ Caution – do not touch the rotating blade.

Your machine is double insulated for safety and requires no earth connection. The operating voltage is 230 V AC, 50 Hz (for non-EU countries 220 V, 240 V as applicable). Only use approved extension cables. Contact your Bosch Service Centre for details.

Extension cords/leads should only be used if they comply with H05VV-F, H05RN-F types or IEC type design (60227 IEC 53, 60245 IEC 57).

If you want to use an extension cable when operating your product, only the following cable dimensions should be used:

- 1.0 mm²: max. length 40 m
- 1.5 mm²: max. length 60 m
- 2.5 mm²: max. length 100 m

Note: If an extension cable is used it must be earthed and connected through the plug to the earth cable of your supply network in accordance with prescribed safety regulations.

If in doubt contact a qualified electrician or the nearest Bosch Service Centre.

- ▶ **WARNING! Inadequate extension cables can be dangerous. Extension cable, plug and socket must be of watertight construction and intended for outdoor use.**

Cable connections should be kept dry and off the ground.

It is recommended for increased electrical safety to use a Residual Current Device (RCD) with a tripping current of not more than 30 mA. Always check your RCD every time you use it.

For products **not sold in GB:**

WARNING: For your safety, it is required that the plug attached to the machine is connected with the extension cord. The coupling of the extension cord must be protected against splash water, be made of rubber or coated with rubber. The extension cord must be used with a cable strain relief.

The connection lead must be inspected for signs of damage at regular intervals and may only be used if in perfect condition.

If the supply cord is damaged, it must be replaced by a Bosch Service Centre.

Products sold in GB only: Your product is fitted with a BS 1363/A approved electric plug with internal fuse (ASTA approved to BS 1362).

If the plug is not suitable for your socket outlets, it should be cut off and an appropriate plug fitted in its place by an authorised customer service agent.

The replacement plug should have the same fuse rating as the original plug. The severed plug must be disposed of to avoid a possible shock hazard and should never be inserted into a mains socket elsewhere.

Products sold in AUS and NZ only:

Use a residual current device (RCD) with a rated residual current of 30 mA or less.









Maintenance

- ▶ **Always wear gardening gloves when handling or working near the sharp blades.**
- ▶ Keep all nuts, bolts and screws tight to be sure that the machine is in safe working condition.

- ▶ Check the grass catcher frequently for wear or deterioration.
- ▶ Examine the machine and replace worn or damaged parts for safety.
- ▶ Ensure replacement cutting means of the right type are used.
- ▶ Ensure replacement parts fitted are Bosch approved.
- ▶ Before storage ensure machine is clean and free from debris, if necessary clean with a soft, dry brush.

Symbols

The following symbols are important for reading and understanding the operating instructions. Please take note of the symbols and their meaning. The correct interpretation of the symbols will help you to use the garden product in a better and safer manner.

Symbol	Meaning
	Movement direction
	Reaction direction
	Wear protective gloves
	Weight
	Switching On
	Switching Off
	Permitted action
	Prohibited action
	Accessories/Spare Parts

Intended Use

The garden product is intended for domestic lawnmowing.

6 | English

Technical Data

Lawnmower		Rotak 32 – 12
Article number		3 600 8A6 0..
Rated power input	W	1 200
Blade width	cm	32
Height of cut	mm	20 – 60
Grassbox, capacity	l	31
Weight according to EPTA-Procedure 01:2014	kg	8.0
Protection class		□/II

Serial number see type plate on the garden product

The values given are valid for a nominal voltage [U] of 230 V. For different voltages and models for specific countries, these values can vary.

Please observe the article number on the type plate of your garden product. The trade names of the individual garden products may vary.

Noise/Vibration Information

Sound emission values determined according to EN 60335-2-77.

Typically the A-weighted noise levels of the product are:
Sound pressure level 79 dB(A); sound power level 93 dB(A).
Uncertainty K = 2 dB.

Vibration total values a_{h1} (triax vector sum) and uncertainty K determined according to EN 60335:
 $a_{h1} < 2,5 \text{ m/s}^2$, K = 1,5 m/s^2 .

Declaration of Conformity

We declare under our sole responsibility that the product described under "Technical Data" is in conformity with all relevant provisions of the directives 2011/65/EU, 2014/30/EU, 2006/42/EC, 2000/14/EC including their amendments and complies with the following standards: EN 60335-1, EN 60335-2-77, EN 50581.

2000/14/EC: Guaranteed sound power level 95 dB(A).
Conformity assessment procedure according to Annex VI.

Equipment category: 32

Notified body:

SRL, Sudbury, England, Nr. 1088

Technical file (2006/42/EC, 2000/14/EC) at:
Bosch Lawn and Garden Ltd., PT-HG/ENS-PA2,
Stowmarket, Suffolk IP14 1EY, England

Henk Becker

Executive Vice President
Engineering

Helmut Heinzelmann

Head of Product Certification
PT/ETM9

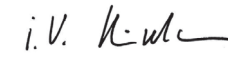
 i.V. 

Robert Bosch Power Tools GmbH
70538 Stuttgart, GERMANY
Stuttgart, 01.01.2017

Mounting and Operation

Action	Figure	Page
Delivery Scope	1	9
Handle Assembly	2	9
Snap together the Grassbox	3	10
Grassbox fitting/removing	3	10
Adjusting the Cutting Height	4	10
Connecting the Extension Lead	5	10
Starting	5	10
Stopping	5	10
Working Advice	5-6	10-11
Blade Maintenance	7	11
Selecting Accessories	7	11

Troubleshooting



Problem	Possible Cause	Corrective Action
Motor refuses to start	Power turned off	Turn power on
	Mains socket faulty	Use another socket
	Extension cable damaged	Inspect cable, replace if damaged
	Fuse faulty/blown	Replace fuse
	Possible clogging	Check underneath the garden product and clear out as necessary (always wear protective gloves)
	Motor protector has activated	Allow motor to cool and increase height of cut
Machine functions intermittently	Mowing too low for the conditions	Increase height of cut
	Extension cable damaged	Inspect cable, replace if damaged
	Internal wiring of machine damaged	Contact Service Agent
Machine leaves ragged finish and/or Motor labours	Motor protector has activated	Allow motor to cool and increase height of cut
	Height of cut too low	Increase height of cut
	Cutting blade blunt	Replace the blade
	Possible clogging	Check underneath the garden product and clear out as necessary (always wear protective gloves)
Blade not rotating while garden product switched on	Blade fitted upside down	Refit blade correctly
	Cutting blade obstructed	Switch off garden product Clear obstruction (always wear protective gloves)
	Blade nut/bolt loose	Tighten blade nut/bolt (17 Nm)
Excessive vibrations/noise	Blade nut/bolt loose	Tighten blade nut/bolt (17 Nm)
	Cutting blade damaged	Replace the blade

After-sales Service and Application Service

www.bosch-garden.com

In all correspondence and spare parts orders, please always include the 10-digit article number given on the type plate of the garden product.

Great Britain

Robert Bosch Ltd. (B.S.C.)
P.O. Box 98
Broadwater Park
North Orbital Road
Denham
Uxbridge
UB 9 5HJ

At www.bosch-pt.co.uk you can order spare parts or arrange the collection of a product in need of servicing or repair.

Tel. Service: (0344) 7360109

E-Mail: boschservicecentre@bosch.com

Ireland

Origo Ltd.
Unit 23 Magna Drive
Magna Business Park
City West
Dublin 24
Tel. Service: (01) 4666700
Fax: (01) 4666888

Australia, New Zealand and Pacific Islands

Robert Bosch Australia Pty. Ltd.
Power Tools
Locked Bag 66
Clayton South VIC 3169
Customer Contact Center
Inside Australia:
Phone: (01300) 307044
Fax: (01300) 307045

8 | English

Inside New Zealand:
Phone: (0800) 543353
Fax: (0800) 428570
Outside AU and NZ:
Phone: +61 3 95415555
www.bosch.com.au

Republic of South Africa

Customer service
Hotline: (011) 6519600

Gauteng – BSC Service Centre

35 Roper Street, New Centre
Johannesburg
Tel.: (011) 4939375
Fax: (011) 4930126
E-Mail: bsctools@icon.co.za

KZN – BSC Service Centre

Unit E, Almar Centre
143 Crompton Street
Pinetown
Tel.: (031) 7012120
Fax: (031) 7012446
E-Mail: bsc.dur@za.bosch.com

Western Cape – BSC Service Centre

Democracy Way, Prosperity Park
Milnerton
Tel.: (021) 5512577
Fax: (021) 5513223
E-Mail: bsc@zsd.co.za

Bosch Headquarters

Midrand, Gauteng
Tel.: (011) 6519600
Fax: (011) 6519880
E-Mail: rbsa-hq.pts@za.bosch.com

Disposal

Do not dispose of garden products into household waste!

Only for EC countries:



According to the European directive 2012/19/EU for Waste Electrical and Electronic Equipment and its implementation into national law, electrical and electronic equipment that are no longer usable must be collected separately and disposed of in an environmentally correct manner.

Subject to change without notice.

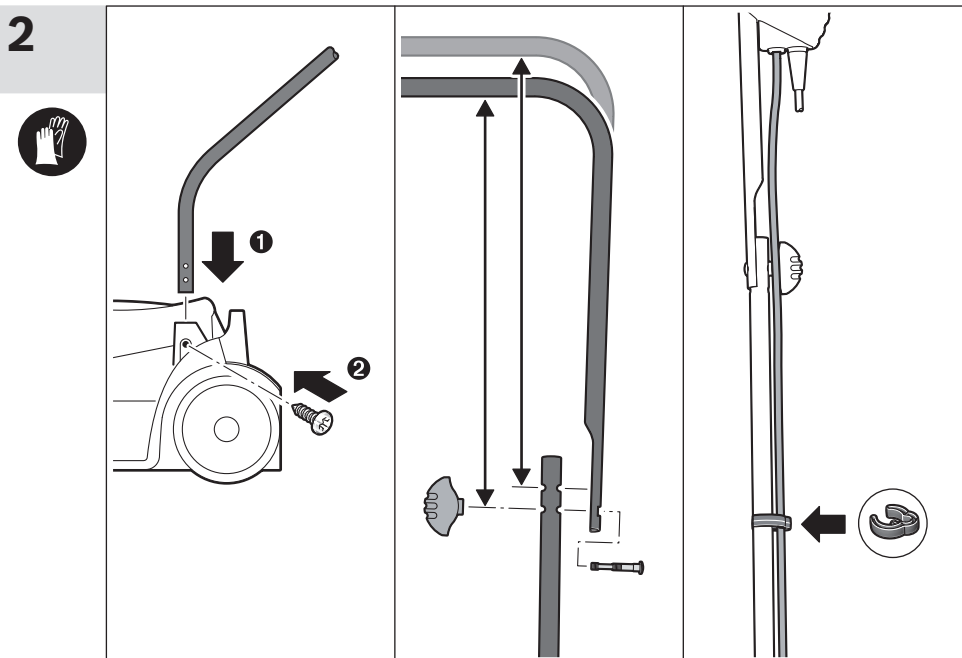
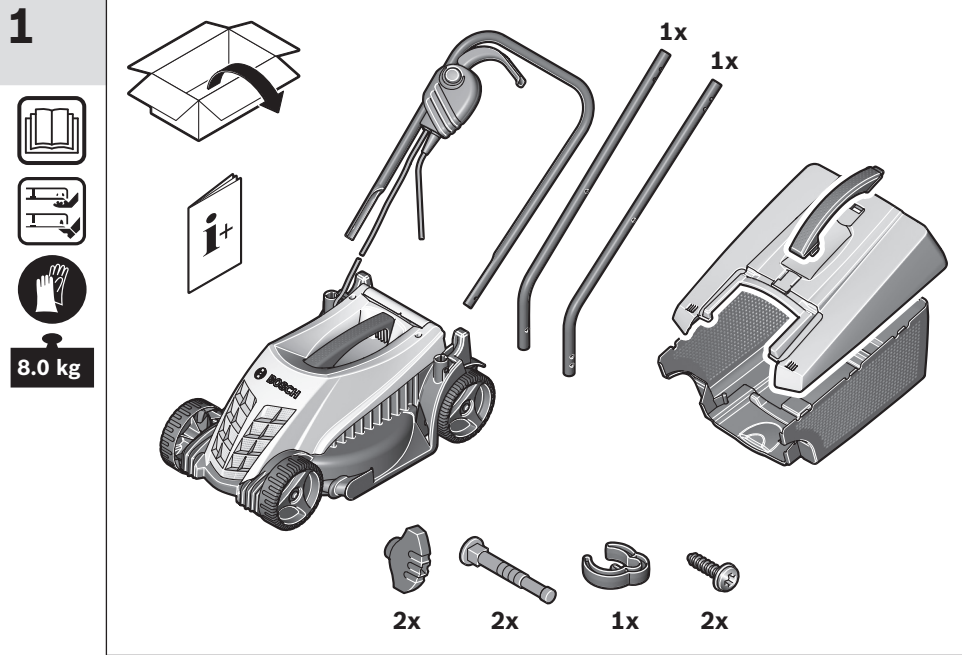

6

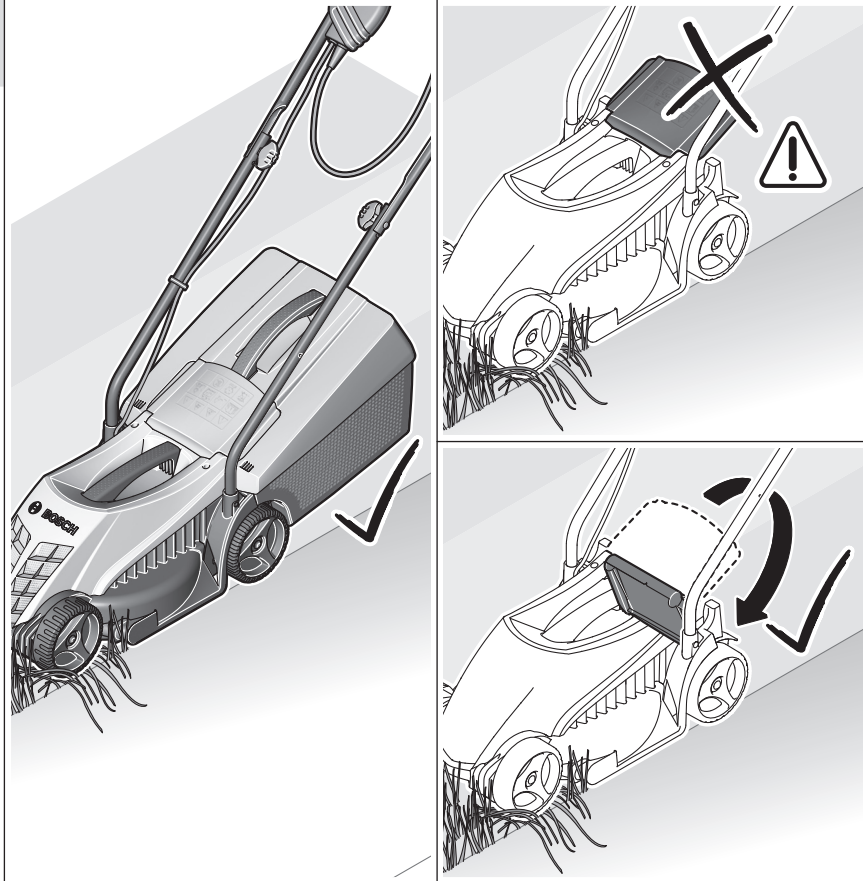

7

