

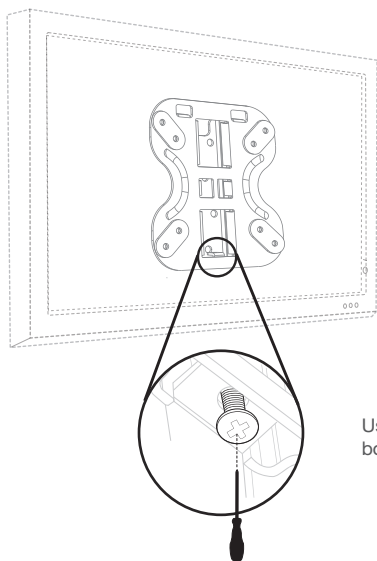

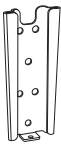







6



Using a screwdriver tighten the securing bolts onto the mount.

**SET INCLUDES**

- |  |  |  |  |
|--|--|--|--|
| <b>A x1</b><br>              | <b>B x4</b><br>              | <b>C x4</b><br>              |  |
| <b>D<sub>1</sub> x4</b><br> | <b>D<sub>2</sub> x4</b><br> | <b>E x4</b><br>             | <b>F x1</b><br>             |
| <b>G<sub>1</sub> x4</b><br> | <b>G<sub>2</sub> x4</b><br> | <b>G<sub>3</sub> x4</b><br> | <b>G<sub>4</sub> x4</b><br> |
| <b>M4</b>  | <b>M4</b>  | <b>M5</b>  | <b>M5</b>  |



**LN2F100**

**Flat to wall  
TV wall mount**

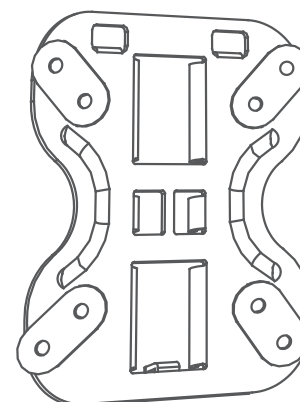

**Easy installation:**  
Scan for installation video  
For more information visit:  
[www.ross.co.uk](http://www.ross.co.uk)

Whilst every effort has been made to ensure that the provided screws are suitable for connecting the mount to the vast majority of TV brands and models, Ross cannot be held responsible on the rare occasion that the supplied screws are not sufficient. Contact us for more information at [help@ross.co.uk](mailto:help@ross.co.uk)

**1**

When selecting the position of the TV mount ensure that it is fixed onto a wooden joist or onto a solid wall. Mark the wall where the fixing locations are ensuring that the mount will be mounted on to a flat surface and is level.

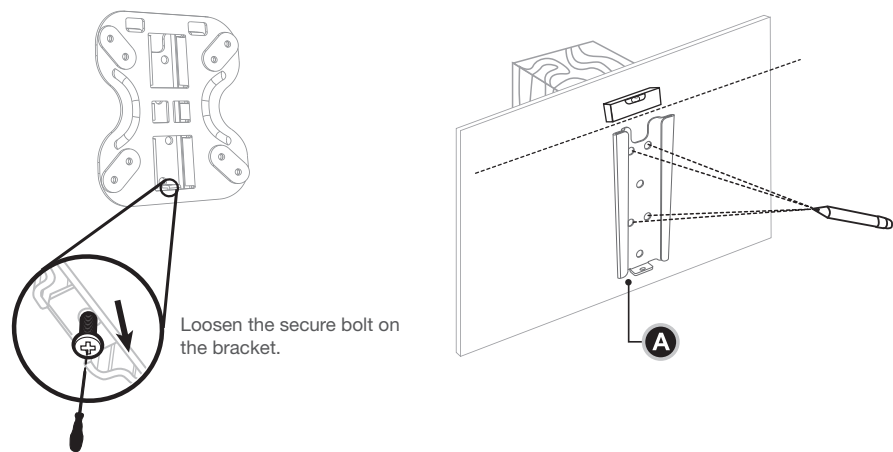
**3**

Taking note which end is the top of the TV, lie your TV onto the floor. Using the assortment of fixings provided select the appropriate ones to hold the mount (G) onto the TV, ensuring that the mount has the threaded hole in the center is at the bottom of the TV ensuring not to over-tighten.

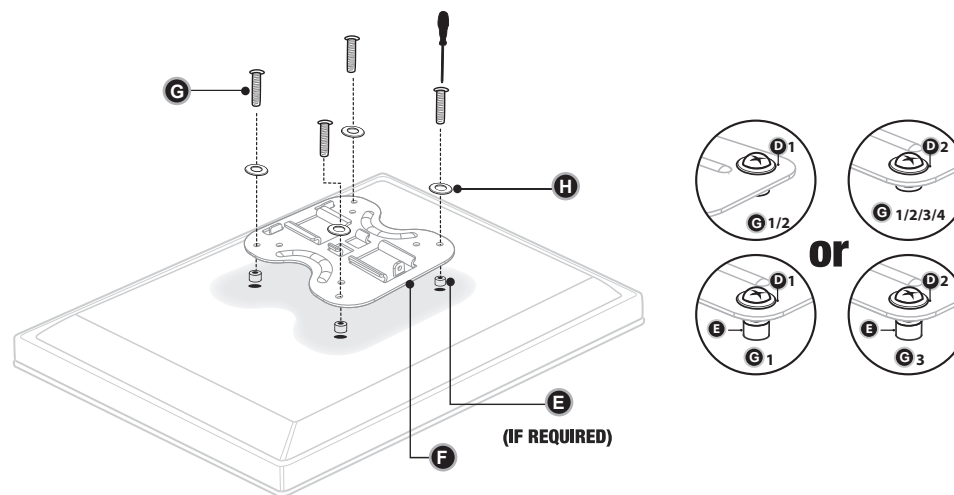
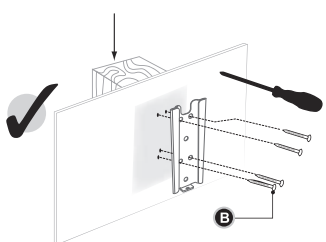
**2**

Using the provided self tapping screws (B) type. Holding the TV mount starting in the one corner, screw the provided screws (B) into a wooden joist fixing the opposite corners, until the mount is secure onto the wall. Ensure all are tight and secure.

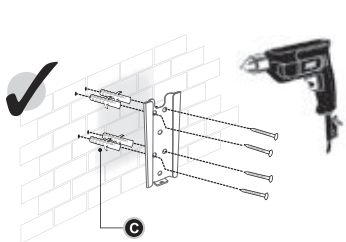

When selecting the position of the TV mount, ensuring that the mount will be mounted on to a flat surface and is level. Mark the wall where the fixing locations are. Drill the holes using a 10mm masonry bit. Using a hammer knock the the wall plugs (C) provided into the wall. Holding the TV mount start in the one corner screw the provided screws (B) into the wall fixing the opposite corners until the mount is secure onto the wall. Ensure all are tight and secure.

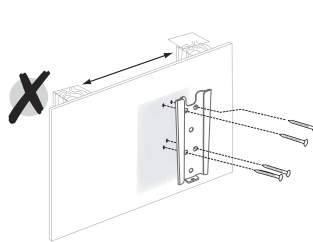

Ensure that the mount is fixed to a solid object and not into plasterboard on its own.

**4**

Hold each side of the TV with the mount facing away from you.

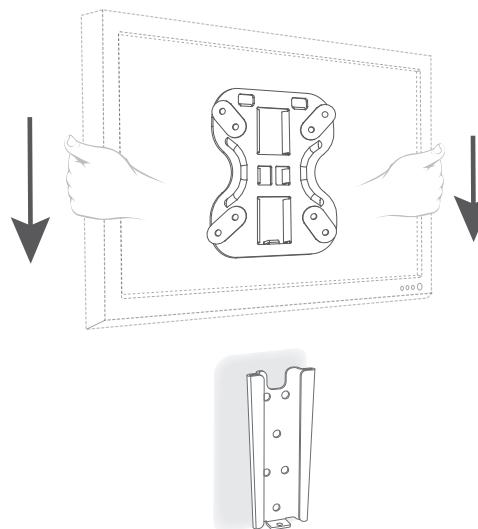
**5**

Slide the TV into grooves the mount ensuring that the TV the threaded hole in the center of the mount is on the bottom.

