

# Installation guide Alex ONE 760x500mm - E8

Please read the instructions in full before starting to fit your radiator.

- Please check that all parts listed are present before starting installation.
- Valves are not provided, please make sure that you have them before you start. This product requires standard 1/2" radiator valves.
- Before drilling holes for the brackets please check that there are no hidden wires or pipes.
- The plugs supplied are for hard walls masonry only. Please make sure you are using the correct plug for your wall.
- Terma radiators are designed for closed heating systems.
- The radiator should be fitted at least 100 mm from the floor to maximise heat efficiency.
- Noting the distances between bracket centres, mark out the position of the brackets on the wall.
- Drill holes to approximately 80 mm depth using a 10 mm drill bit and insert rawl plugs (1). Using connecting screw with a washer (2) attach mounting bracket-1 (3).
- Guide radiator brackets into mounting brackets - 1(3) and fix with connecting screws (4)
- Connect the water flow using appropriate 1/2" BSP valves. Follow valves manufacture guidelines for correct installation.
- Fill the radiator and purge any trapped air via the bleed valve at the top of the radiator.
- Wipe your radiator down using a clean damp cloth. Never use scourers or abrasives.

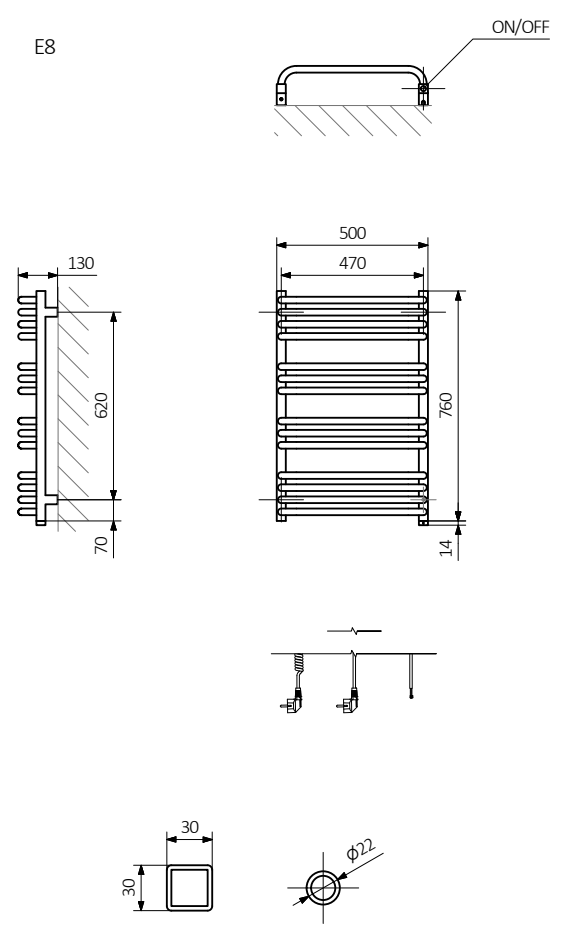

## Fixing kit content

rawl plug (1)

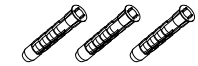

wall fixing (2)  
screw +  
washer

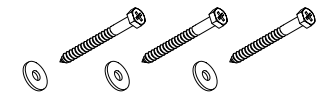

mounting (3)  
bracket-1

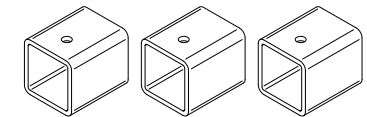

bracket to (4)  
collector  
fixing screw



air vent \*



allen key



\*Refers to water and dual fuel version

For all installation and warranty enquiries please contact Crimson Bear Customer Support on 01535 636256

# Mounting bracket TERMA P4, P/S, 40 mm, 3x

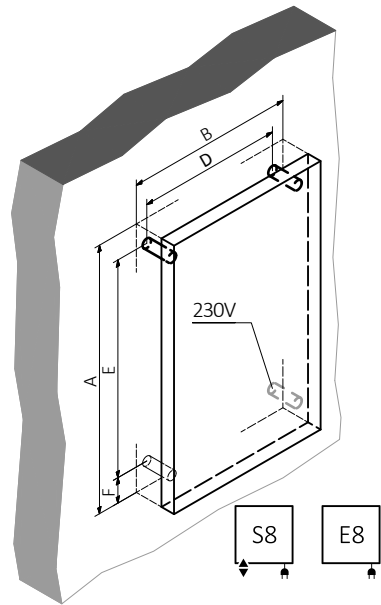
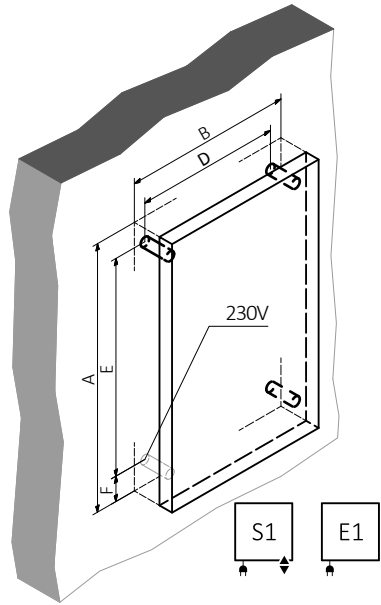

<p><b>1</b></p>	<p><b>2</b></p>	<p><b>3</b></p>	<p><b>4</b></p>
<p><b>5</b></p>	<p><b>6*</b></p>		<p><b>7*</b></p>

\*Refers to water and dual fuel version only