

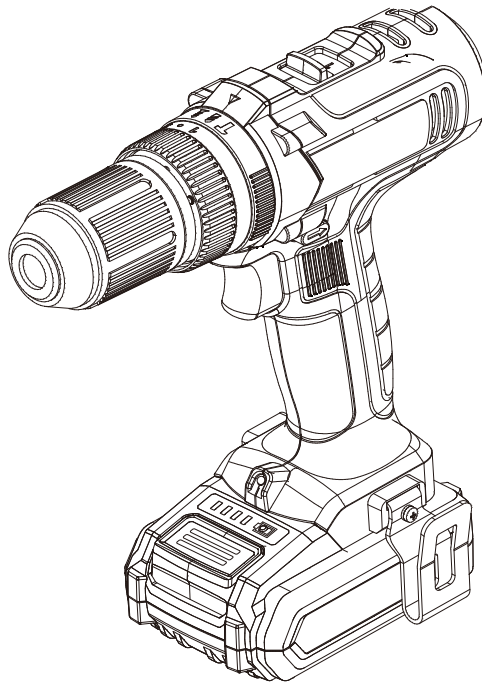

EN

# TITAN



## TTI884COM



WARNING: Read the instructions before using the product!

V11221 / BX220IM

# Let's get started...

These instructions are for your safety. Please read through them thoroughly before use and retain them for future reference.



## Getting **started...** 02

<b>Safety</b> information	03
<b>Your</b> product	17
<b>Before</b> you start	20



## **In more detail...** 24

<b>Product</b> functions	25
<b>Care</b> and <b>maintenance</b>	31
<b>Troubleshooting</b>	33
<b>Recycling</b> and <b>disposal</b>	34
<b>Guarantee</b>	35
<b>Declaration</b> of <b>conformity</b>	36

## Safety warnings

### General power tool safety warnings



**WARNING!** Read all safety warnings, instructions, illustrations and specifications provided with this power tool. *Failure to follow all instructions listed below may result in electric shock, fire and/or serious injury.*

**Save all warnings and instructions for future reference.**

*The term “power tool” in the warnings refers to your mains-operated (corded) power tool or battery-operated (cordless) power tool.*

#### 1) Work area safety

- a) **Keep work area clean and well lit.** *Cluttered or dark areas invite accidents.*
- b) **Do not operate power tools in explosive atmospheres, such as in the presence of flammable liquids, gases or dust.** *Power tools create sparks which may ignite the dust or fumes.*
- c) **Keep children and bystanders away while operating a power tool.** *Distractions can cause you to lose control.*

#### 2) Electrical safety

- a) **Power tool plugs must match the outlet. Never modify the plug in any way. Do not use any adapter plugs with earthed (grounded) power tools.** *Unmodified plugs and matching outlets will reduce risk of electric shock.*

Getting started...

## Safety warnings

- b) **Avoid body contact with earthed or grounded surfaces, as pipes, radiators, ranges and refrigerators.** *There is an increased risk of electric shock if your body is earthed or grounded.*
  - c) **Do not expose power tools to rain or wet conditions.** *Water entering a power tool will increase the risk of electric shock.*
  - d) **Do not abuse the cord. Never use the cord for carrying, pulling or unplugging the power tool. Keep cord away from heat, oil, sharp edges or moving parts.** *Damaged or entangled cords increase the risk of electric shock.*
  - e) **When operating a power tool outdoors, use an extension cord suitable for outdoor use.** *Use of a cord suitable for outdoor use reduces the risk of electric shock.*
  - f) **If operating a power tool in a damp location is unavoidable, use a residual current device (RCD) protected supply.** *Use of an RCD reduces the risk of electric shock.*
- 3) Personal safety**
- a) **Stay alert, watch what you are doing and use common sense when operating a power tool. Do not use a power tool while you are tired or under the influence of drugs, alcohol or medication.** *A moment of inattention while operating power tools may result in serious personal injury.*
  - b) **Use personal protective equipment. Always wear eye protection.** *Protective equipment such as a dust mask, non-skid safety shoes, hard hat, or hearing protection used for appropriate conditions will reduce personal injuries.*

- c) **Prevent unintentional starting. Ensure the switch is in the off-position before connecting to power source and/or battery pack, picking up or carrying the tool.** *Carrying power tools with your finger on the switch or energising power tools that have the switch on invites accidents.*
  - d) **Remove any adjusting key or wrench before turning the power tool on.** *A wrench or a key left attached to a rotating part of the power tool may result in personal injury.*
  - e) **Do not overreach. Keep proper footing and balance at all times.** *This enables better control of the power tool in unexpected situations.*
  - f) **Dress properly. Do not wear loose clothing or jewellery. Keep your hair, clothing and gloves away from moving parts.** *Loose clothes, jewellery or long hair can be caught in moving parts.*
  - g) **If devices are provided for the connection of dust extraction and collection facilities, ensure these are connected and properly used.** *Use of dust collection can reduce dust-related hazards.*
  - h) **Do not let familiarity gained from frequent use of tools allow you to become complacent and ignore tool safety principles.** *A careless action can cause severe injury within a fraction of a second.*
- 4) Power tool use and care**
- a) **Do not force the power tool. Use the correct power tool for your application.** *The correct power tool will do the job better and safer at the rate for which it was designed.*
  - b) **Do not use the power tool if the switch does not turn it on and off.** *Any power tool that cannot be controlled with the switch is dangerous and must be repaired.*

## Safety warnings

- c) **Disconnect the plug from the power source and/ or remove the battery pack, if detachable, from the power tool before making any adjustments, changing accessories, or storing power tools.** *Such preventive safety measures reduce the risk of starting the power tool accidentally.*
- d) **Store idle power tools out of the reach of children and do not allow persons unfamiliar with the power tool or these instructions to operate the power tool.** *Power tools are dangerous in the hands of untrained users.*
- e) **Maintain power tools and accessories. Check for misalignment or binding of moving parts, breakage of parts and any other condition that may affect the power tool's operation. If damaged, have the power tool repaired before use.** *Many accidents are caused by poorly maintained power tools.*
- f) **Keep cutting tools sharp and clean.** *Properly maintained cutting tools with sharp cutting edges are less likely to bind and are easier to control.*
- g) **Use the power tool, accessories and tool bits etc. in accordance with these instructions, taking into account the working conditions and the work to be performed.** *Use of the power tool for operations different from those intended could result in a hazardous situation.*
- h) **Keep handles and grasping surfaces dry, clean and free from oil and grease.** *Slippery handles and grasping surfaces do not allow for safe handling and control of the tool in unexpected situations.*

## 5) Battery tool use and care

- a) **Recharge only with the charger specified by the manufacturer.** *A charger that is suitable for one type of battery pack may create a risk of fire when used with another battery pack.*
- b) **Use power tools only with specifically designated battery packs.** *Use of any other battery packs may create a risk of injury and fire.*
- c) **When battery pack is not in use, keep it away from other metal objects, like paper clips, coins, keys, nails, screws or other small metal objects, that can make a connection from one terminal to another.** *Shorting the battery terminals together may cause burns or a fire.*
- d) **Under abusive conditions, liquid may be ejected from the battery; avoid contact. If contact accidentally occurs, flush with water. If liquid contacts eyes, additionally seek medical help.** *Liquid ejected from the battery may cause irritation or burns.*
- e) **Do not use a battery pack or tool that is damaged or modified.** *Damaged or modified batteries may exhibit unpredictable behaviour resulting in fire, explosion or risk of injury.*
- f) **Do not expose a battery pack or tool to fire or excessive temperature.** *Exposure to fire or temperature above 130 °C may cause explosion.*
- g) **Follow all charging instructions and do not charge the battery pack or tool outside the temperature range specified in the instructions.** *Charging improperly or at temperatures outside the specified range may damage the battery and increase the risk of fire.*

## Safety warnings

### 6) Service

- a) **Have your power tool serviced by a qualified repair person using only identical replacement parts.** *This will ensure that the safety of the power tool is maintained.*
- b) **Never service damaged battery packs.** *Service of battery packs should only be performed by the manufacturer or authorized service providers.*

### Drill / screwdriver safety warnings

#### Safety Instructions for all operations

1. **Wear ear protectors when impact drilling.** *Exposure to noise can cause hearing loss.*
2. **Hold power tool by insulated gripping surfaces, when performing an operation where the cutting accessory may contact hidden wiring.** *Cutting accessory contacting a "live" wire may make exposed metal parts of the power tool "live" and could give the operator an electric shock.*
3. **Safety instructions when using long drill bits**
  - a. Never operate at higher speed than the maximum speed rating of the drill bit. At higher speeds, the bit is likely to bend if allowed to rotate freely without contacting the workpiece, resulting in personal injury.
  - b. Always start drilling at low speed and with the bit tip in contact with the workpiece. At higher speeds, the bit is likely to bend if allowed to rotate freely without contacting the workpiece, resulting in personal injury.



- c. Apply pressure only in direct line with the bit and do not apply excessive pressure. Bits can bend causing breakage or loss of control, resulting in personal injury.

### **Additional safety warnings for battery pack**

- a) **Battery pack needs to be charged before use.** *Always refer to the charger's instruction and charge it properly.*
- b) **Remove the battery pack from the product when not in use.**
- c) **Don't maintain the battery pack on the charger when not in use.**
- d) **After extended periods of storage, it may be necessary to charge and discharge the battery pack several times to obtain the maximum performance.**
- e) **Longer life and better performance can be obtained if the battery is charged when the air temperature is between 18 °C and 24 °C. Do not charge the battery in air temperature below 5 °C or above 40 °C. This is important as it can prevent serious damage to the battery.**
- f) **Do not charge battery in a damp or wet location.** *Following this rule will reduce the risk of electric shock.*
- g) **Do not disassemble the battery and avoid mechanical damage to the battery. Risk of short circuit and fumes may be emitted. Ensure fresh air and seek medical assistance in the event of discomfort.**
- h) **When disposing of battery pack, keep the battery pack of different electrochemical systems separate from each other.**

## Safety warnings

**The following information applies to professional users only but is good practice for all users:**

### **ADDITIONAL SAFETY WARNING FOR CONSTRUCTION DUST**

The updated Control of Substances Hazardous to Health Regulations 1st October 2012 now also targets to reduce the risks associated with silica, wood and gypsum dusts. Construction workers are one of the at-risk groups within this because of the dust that they breathe: silica dust is not just a nuisance; it is a real risk to your lungs!

Silica is a natural mineral present in large amounts in things like sand, sandstone and granite. It is also commonly found in many construction materials such as concrete and mortar. The silica is broken into very fine dust (also known as Respirable Crystalline Silica or RCS) during many common tasks such as cutting, drilling and grinding. Breathing in very fine particles of crystalline silica can lead to the development of:

- Lung cancer
- Silicosis
- Chronic Obstructive Pulmonary Disorder / Chronic obstructive pulmonary disease (COPD)

And breathing in fine particles of wood dust can lead to the development of Asthma. The risk of lung disease is linked to people who regularly breathe construction dust over a period of time, not on the odd occasion.

To protect the lung, the COSHH Regulations sets a limit on the amount of these dusts that you can breathe (called a Workplace Exposure Limit or WEL) when averaged over a normal working day. These limits are not a large amount of dust: when compared to a penny it is tiny – like a small pinch of salt:

This limit is the legal maximum; the most you can breathe after the right controls have been used.

## HOW TO REDUCE THE AMOUNT OF DUST?

- a) Reduce the amount of cutting by using the best sizes of building products.
- b) Use a less powerful tool e.g. a block cutter instead of angle grinder.
- c) Using a different method of work altogether – e.g. using a nail gun to direct fasten cable trays instead of drilling holes first.

Please always work with approved safety equipment, such as those dust masks that specially designed to filter out microscopic particles and use the dust extraction facility at all time.

For more information please see the HSE website:  
<http://www.hse.gov.uk/construction> or <http://www.hse.gov.uk/pubns/cis69.pdf>



**WARNING!** Some dust particles created by power sanding, sawing, grinding, drilling and other construction jobs contain chemicals known to cause cancer, birth defects or other reproductive harm. Some examples of these chemicals are:

- Lead from lead-based paints.
- Crystalline silica from bricks and cement and other masonry products.
- Arsenic and chromium from chemically treated timber.

Your risk from these exposures varies, depending upon how often you do this type of work. To reduce your exposure to these chemicals:

- Work in a well-ventilated area.
- Work with approved safety equipment, such as those dust masks that are specially designed to filter microscopic particles.

## Safety warnings

### VIBRATION

The European Physical Agents (Vibration) Directive has been brought in to help reduce hand arm vibration syndrome injuries to power tool users. The directive requires power tool manufacturers and suppliers to provide indicative vibration test results to enable users to make informed decisions as to the period of time a power tool can be used safely on a daily basis and the choice of tool.

**SEE TECHNICAL SPECIFICATIONS IN THE INSTRUCTION MANUAL FOR THE VIBRATION LEVELS OF YOUR TOOL.**

The declared vibration emission value should be used as a minimum level and should be used with the current guidance on vibration.

Calculating the actual period of use can be difficult and the HSE website has further information.

The declared vibration emission value has been measured in accordance EN 62841-1 and EN 62841-2-1 and may be used to compare one tool with another.

The declared vibration emission value may also be used in a preliminary assessment of exposure.



**WARNING!** The vibration emission value during actual use of the power tool can differ from the declared value depending on the ways in which the tool is used:

- How the materials are grinded, cut or drilled.
- If the tool is in good condition and well maintained.
- Use correct accessory for the tool and ensure it is sharp and in good condition.
- The tightness of the gripping handles.
- The tool is being used as intended by its design and these instructions.

While working with this power tool, hand/arm vibrations occur. Adopt the correct working practices in order to reduce the exposure to vibration. This tool may cause hand-arm vibration syndrome if its use is not adequately managed.



**WARNING!** Identify safety measures to protect the operator that are based on an estimation of exposure in the actual conditions of use (taking account of all parts of the operating cycle such as the times when the tool is switched off and when it is running idle in addition to the trigger time).

**Note:**

- The use of other tools will reduce the users' total working period on this tool.
- Helping to minimise your vibration exposure risk. ALWAYS use sharp chisels, drills and blades.
- Maintain this tool in accordance with these instructions and keep well lubricated (where appropriate).
- Avoid using tools in temperatures of 10 °C or less. Plan your work schedule to spread any high vibration tool use across a number of days.

## Safety warnings

### Health surveillance

All employees should be part of an employer's health surveillance scheme to help identify any vibration related diseases at an early stage, prevent disease progression and help employees stay in work.

### Vibration and noise reduction

**To reduce the impact of noise and vibration emission, limit the time of operation, use low-vibration and low-noise operating modes as well as wear personal protective equipment.**

Take the following points into account to minimise the vibration and noise exposure risks:

- a) Only use the product as intended by its design and these instructions.
- b) Ensure that the product is in good condition and well maintained.
- c) Use correct attachments for the product and ensure they are in good condition.
- d) Keep tight grip on the handles/grip surface.
- e) Maintain this product in accordance with these instructions and keep it well lubricated (where appropriate).
- f) Plan your work schedule to spread any high vibration tool use across a longer period of time.
- g) Prolonged use of the product exposes the user to vibrations that can cause a range of conditions collectively known as hand-arm vibration syndrome (HAVS) e.g. fingers going white; as well as specific diseases such as carpal tunnel syndrome. To reduce this risk when using the product, always wear protective gloves and keep your hands warm.

## Emergency

Familiarise yourself with the use of this product by means of this instruction manual. Memorise the safety directions and follow them to the letter. This will help to prevent risks and hazards.

- a) **Always be alert when using this product, so that you can recognise and handle risks early.** *Fast intervention can prevent serious injury and damage to property.*
- b) **Switch off and disconnect from the power supply if there are malfunctions.** *Have the product checked by a qualified professional and repaired, if necessary, before you operate it again.*

## Residual risks

Even if you are operating this product in accordance with all the safety requirements, potential risks of injury and damage remain. The following dangers can arise in connection with the structure and design of this product:



- a) Health defects resulting from vibration emission if the product is being used over long periods of time or not adequately managed and properly maintained.
- b) Injuries and damage to property due to broken cutting attachments or the sudden impact of hidden objects during use.
- c) Danger of injury and property damage caused by flying objects or poor power tool accessories.



**WARNING!** This product produces an electromagnetic field during operation! This field may under some circumstances interfere with active or passive medical implants! To reduce the risk of serious or fatal injury, we recommend persons with medical implants to consult their doctor and the medical implant manufacturer before operating this product!

## Symbols

On the product, the rating label and within these instructions you will find among others the following symbols and abbreviations. Familiarise yourself with them to reduce hazards like personal injuries and damage to property.

$V \text{ ---}$	Volt, (direct current voltage)	mAh	Milliampere per hour
/min or min <sup>-1</sup>	Per minute	°C	Degree Celsius
g	Gram	kg	Kilogram
mm	Millimetre	m	Metre
cm	Centimeter	n0	No-load speed
dB(A)	Decibel (A-rated)	m/s <sup>2</sup>	Metres per second squared
	Lock / to tighten or secure.		Unlock / to loosen.



Read the instruction manual.



Note / Remark.



Caution / Warning.

xxWyy Manufacturing date code; year of manufacturing (20xx) and week of manufacturing (Wyy)



Wear hearing protection.



Wear eye protection.



Wear a dust mask.



Wear protective gloves.



Wear protective, slip-resistant footwear.



Switch the product off and remove battery pack before assembly, cleaning, adjustments, maintenance, storage and transportation.



WEEE symbol. Waste electrical products should not be disposed of with household waste. Please recycle where facilities exist. Check with your Local Authority or local store for recycling advice.



Crossed out dust bin. Batteries and battery packs should not be disposed of with household waste. Please recycle where facilities exist. Check with your Local Authority or local store for recycling advice.



Do not dispose of battery packs in rivers or immerse in water.



Do not dispose of battery packs in fire. They will explode and cause injury.





Do not expose battery packs to heat in excess of 45 °C. Do not charge or store the battery pack in temperatures below 0 °C (32 °F) and above 45 °C (113°F).



The product complies with the applicable European directives and an evaluation method of conformity for these directives was done. UK Conformity Assessed.

## Your product

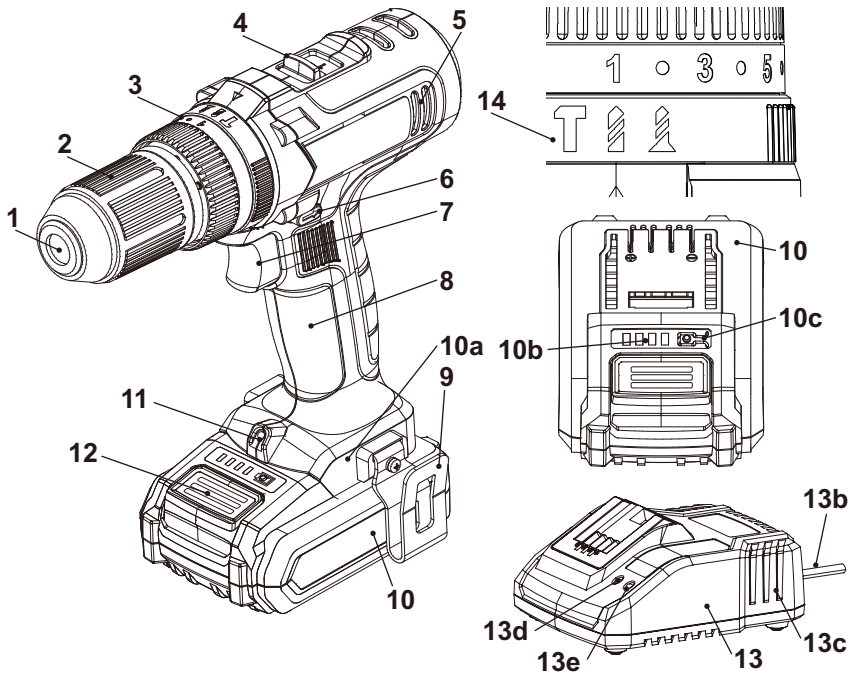

Getting started...

## Your product

- |                                       |                                |   |
|---------------------------------------|--------------------------------|---|
| 1. Chuck jaws                         | 10. Battery pack               | a) Sliding slots                            |
| 2. Keyless chuck                      | a) Battery docking port        | b) Power cord with plug                     |
| 3. Torque ring                        | b) Battery capacity indicators | c) Air vents                                |
| 4. Gearbox switch                     | c) Battery capacity button     | d) Charging status indicator ( <b>RED</b> ) |
| 5. Air vents                          | 11. Work light                 | e) Power indicator ( <b>GREEN</b> )         |
| 6. Forward / reverse rotation control | 12. Release button             | 14. Function selection ring                 |
| 7. On/off switch                      | 13. Charger                    |   |
| 8. Handle                             |                                |   |
| 9. Belt clip                          |                                |   |



**NOTE:** Parts marked with \* are not shown in this overview. Please refer to the respective part in the instruction manual.

## Technical specifications

### General

- > **Rated voltage** : 18 V
- > **Rated no load speed  $n_0$**  : 0 - 400 / 0 - 1500 min<sup>-1</sup>
- > **Drill chuck capacity** : max. Ø 13 mm
- > **Torque setting** : 16 + 1 + 1 positions
- > **Weight** : approx. 1.5 kg (including battery pack)
- > **Dimensions** : approx. 220 x 80 x 220 mm

### Drilling capacity

- > **in wood** : Ø 30 mm
- > **in metal** : Ø 10 mm
- > **in concrete** : Ø 13 mm

### Battery pack

- > **Model no.** : TTI801BAT
- > **Cell** : Li-Ion, 5 pcs
- > **Capacity** : 2000 mAh
- > **Voltage** : 18 V
- > **Weight** : approx. 0.4 kg

### Charger

- > **Model no.** : TTB804CHR
- > **Rated output** : 21.4V d.c., 2.4 A

**Usable battery pack (sold separately)**

> Model no.	: TTI802BAT	TTI803BAT
> Capacity	: 4000 mAh	5000 mAh

**Usable charger (sold separately)**

> Model no.	: TTB805CHR
> Rated output	: 21.4V d.c., 4 A
> Ambient temperature range for charger and battery use	: 5 °C to 40 °C

**Sound values**

> Sound pressure level $L_{pA}$	: 79.7 dB (A)
> Sound power level $L_{WA}$	: 90.7 dB (A)
> Uncertainty $K_{pA}$ , $K_{WA}$	: 5 dB (A)

**Hand arm vibration values**

> Drilling into metal $a_{h,D}$	: 1.111 m/s <sup>2</sup>
> Impact drilling into concrete $a_{h,ID}$	: 9.27 m/s <sup>2</sup>
> Uncertainty K	: 1.5 m/s <sup>2</sup>

The sound values have been determined according to noise test code given in EN 62841-1 and EN 62841-2-1, using the basic standards EN ISO 3744 and EN ISO 11203.

The sound intensity level for the operator may exceed 80 dB(A) and ear protection measures are necessary.

The declared vibration total values and the declared noise emission values have been measured in accordance with a standard test method (according to EN 62841-1 and EN 62841-2-1) and may be used for comparing one product with another; they may also be used in a preliminary assessment of exposure.



**WARNING!** The vibration and noise emissions during actual use of the power tool can differ from the declared values depending on the ways in which the tool is used especially what kind of workpiece is processed; and need to identify safety measures to protect the operator that are based on an estimation of exposure in the actual conditions of use (taking account of all parts of the operating cycle such as the times when the tool is switched off and when it is running idle in addition to the trigger time).

## Rating label explanation

TTI884COM = Model number

TT = TITAN

I = 18V Lithium-Ion

884 = Serial Number

COM = Cordless Combi Drill

## Unpacking

1. Unpack all parts and lay them on a flat, stable surface.
2. Remove all packing materials and shipping devices if applicable.
3. Make sure the delivery contents are complete and free of any damage. If you find that parts are missing or show damage do not use the product but contact your dealer. Using an incomplete or damaged product represents a hazard to people and property.
4. Ensure that you have all the accessories and tools needed for assembly and operation. This also includes suitable personal protective equipment.



**WARNING!** The product must be fully assembled before operation! Do not use a product that is only partly assembled or assembled with damaged parts!



Wear protective gloves for this assembly work and always lay the product on a flat and stable surface while assembling.

Follow the assembly instructions step-by-step and use the pictures provided as a visual guide to easily assemble the product!



Do not insert the battery pack before the power tool is completely assembled!



**WARNING!** The product and the packaging are not children's toys! Children must not play with plastic bags, sheets and small parts! There is a danger of choking and suffocation!

## You will need

### (items not supplied)

Suitable drill bits  
 Suitable driver bits  
 Bit holder  
 Cooling lubricant (for drilling into metal)

### (items supplied)

Battery pack (10)  
 Charger (13)



**NOTE:** The accessories required depend on the intended application. Ask your dealer for advice.

## Setup



**WARNING!** The product must be fully assembled before operation! Do not use a product that is only partly assembled or assembled with damaged parts!



Follow the assembly instructions step-by-step and use the pictures provided as a visual guide to easily assemble the product! Do not insert the battery before it is completely assembled!

## Inserting

1. Turn the chuck sleeve (2) anticlockwise until the chuck jaws (1) are opened wide enough to insert the drill bit (Fig. 1).
2. Insert the drill bit all the way to the stop (Fig. 2). For smaller drill bits ensure sufficient work length. If using a 25 mm driver bit, insert it into the socket of a bit holder.
3. Turn the chuck sleeve (2) clockwise until the drill bit is properly fastened in the chuck jaws (1) (Fig. 3).

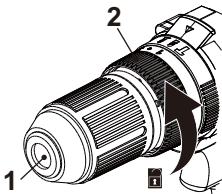

Fig. 1

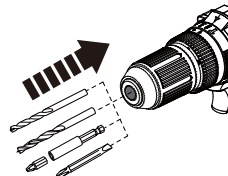

Fig. 2

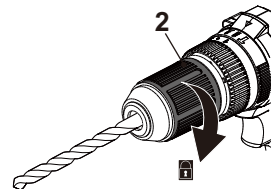

Fig. 3



**WARNING!** After short operation, switch the product off and check once again that the bit is properly fastened! Caution, the bit could be hot!



## Setup



**NOTE:** Use a suitable bit holder to access areas that are hard to reach. Insert the bit holder into the socket in the same way as the driver bits, then insert a driver bit into the bit holder.

### Removing / Replacing

1. Turn the chuck sleeve (2) anticlockwise until the chuck jaws (1) are opened wide enough to remove the bit.
2. Remove the bit and insert a new one as described above if desired.

## Battery pack

### Attach / Release

1. Lock the on/off switch (7) to avoid accidental starting by moving the forward / reverse rotation control (6) into the centre position (see below section “Product functions – Forward / reverse rotation control”).
2. Align the battery pack (10) with the sliding slots of the battery docking port (10a) and slide the battery pack in to attach it. Ensure it clicks in place (Fig. 4).
3. Press the release button (12) and slide the battery pack (10) from the battery docking port (12) (Fig. 5).

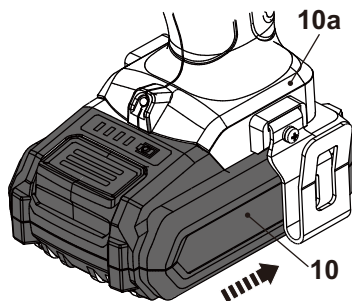

Fig. 4

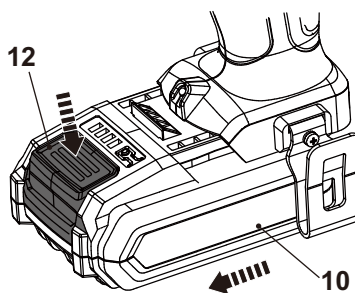

Fig. 5

## Charging

### Charging the battery pack

The battery pack (10) for this product has been shipped in a low charge condition. Charge it fully before first use.

1. Refer to the charger's instruction manual for the details.

The battery pack (10) is equipped with the battery capacity indicators (10b) which are used to give an indication of the battery pack's remaining capacity. Press the battery capacity button (10c) to check battery capacity (Fig. 6). The LEDs will stay lit for approximately 10 seconds.

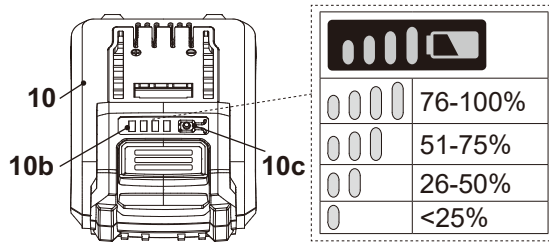
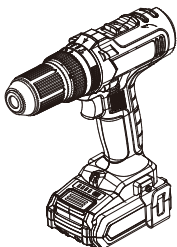

Fig. 6

# In more detail...



<b>Product functions</b>	25
<b>Care and maintenance</b>	31
<b>Troubleshooting</b>	33
<b>Recycling and disposal</b>	34
<b>Guarantee</b>	35
<b>Declaration of conformity</b>	36





## Intended use

This product is intended for drilling in wood and similar materials e.g. MDF, plywood etc., plastic, metal and impact drilling in brick, tile and concrete, as well as for screw driving. It should not be used for working on materials that are dangerous to health.

For safety reasons it is essential to read the entire instruction manual before first operation and to observe all the instructions therein.

This product is intended for private domestic use only, not for any commercial trade use. It must not be used for any purposes other than those described.

## General operation

1. Check the product, its battery pack and charger as well as accessories for damage before each use. Do not use the product if it is damaged or shows wear.
2. Double check that the accessories and attachments are properly fixed.
3. Always hold the product by its handle (8). Keep the handle dry to ensure safe support.
4. Ensure that the air vents are always unobstructed and clear. Clean them if necessary with a soft brush. Blocked air vents may lead to overheating and damage the product.
5. Switch the product off immediately if you are disturbed while working by other people entering the working area. Always let the product come to complete stop before putting it down.
6. Do not overwork yourself. Take regular breaks to ensure you can concentrate on the work and have full control over the product.

## Function selection ring

Three working modes are available on this tool: drilling, screw driving and impact drilling. To select any of the three modes, rotate the function selection ring (14), to align the arrow with icon of the drill/screw/ hammer on the housing. (Fig. 7).

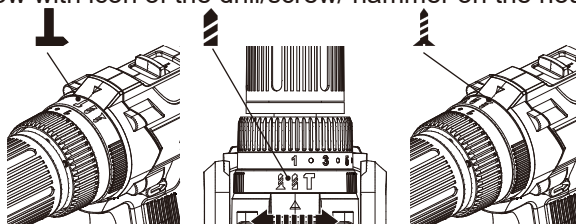

Fig. 7

In more detail...

## Function selection ring



Screw driving mode for driving screws



Drilling mode for drilling into wood, plastic and metal



Impact drilling mode for impact drilling into brick, tile and concrete

## Forward / reverse rotation control

Change the rotational direction from forward to reverse by pressing the forward / reverse rotation control (6).





**WARNING!** Only change the rotational direction when the product is switched off and has come to a complete stop! Always ensure that the forward / reverse rotation control is adjusted to the correct position depending on the intended operation!

Always push the forward / reverse rotation control as far as it will go! Do not use the product with the control switch in any other position!

1. Move the forward / reverse rotation control (6) to the left (as seen from the operators position) in order to use the product in a clockwise rotational mode (Fig. 8).
2. Move the forward / reverse rotation control (6) to the right (as seen from the operators position) in order to use the product in anticlockwise rotational mode (Fig. 9).
3. Move the forward / reverse rotation control (6) to the centre position to lock the on/off switch (7) and avoid accidental starting (Fig. 10).

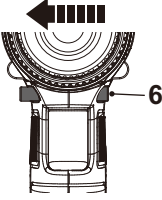
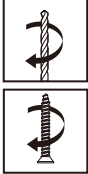
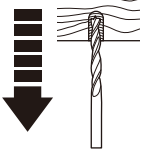
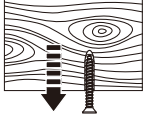
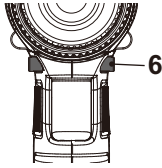
Position	Rotational direction	Application	
<p>Fig. 8</p>		<p>Drilling into material</p>	<p>Screw driving</p>

Position	Rotational direction	Application	
 <p>Fig. 9</p>		 <p>Loosen jammed drill bits</p>	 <p>Remove screw</p>
 <p>Fig. 10</p>		 <p>Lock the on/off switch and avoid accidental starting</p>	

**i** **NOTE:** If you are using the product for the first time after changing the rotational direction, a locking sound may be heard. This is normal and does not represent a defect.

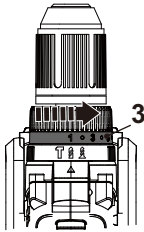

## Torque ring

Limit the maximum torque for screw driving operations using the torque ring (3). The range of torque settings allows better control when using the product as a screwdriver as it prevents over-tightening of screws. Turn the torque ring (3) until the desired number / symbol aligns with the arrow. Fig. 11 - 13

Torque ring	Torque / Clutch	Application
 <p>Fig. 11</p>	<p>Decreased max. torque</p>	<p>Screwing smaller diameter screws, screwing them into soft materials</p>

In more detail...

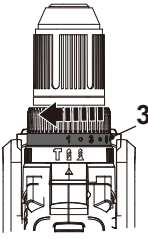
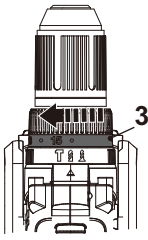
## Torque ring

Torque ring	Torque / Clutch	Application
 <p>Fig. 12</p>	Increased max. torque	Screwing larger diameter screws, screwing into hard materials
 <p>Fig. 13</p>	Clutch is locked 	Drilling operation into metal, wood, plastic



**WARNING!** The torque settings are only for screw driving and not for drilling operations! For other operations than screw driving the clutch must be locked; turn the torque ring to the respective symbol!

## Gearbox switch

Set the torque-speed combination to suit the intended application with gearbox switch (4).

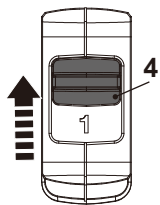
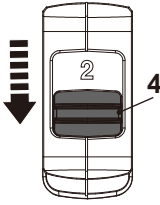

**WARNING!** Only change the gears when the product is switched off and has come to a complete stop! Always ensure that the gearbox switch as far as it will go. Do not use the product when the switch is in any other intermediate position!

Position	Speed / Torque	Application
 <p>Fig. 14</p>	Low speed / high torque	Large diameter drill bits working on hard materials
 <p>Fig. 15</p>	High speed / low torque	Small diameter drill bits working on soft materials



**NOTE:** If you have difficulties changing from one gear to another, turn the drill chuck by hand until the gears engage.

## Automatic work light

The work light (11) will automatically illuminate by pressing the on/off switch (7) (Fig. 16).

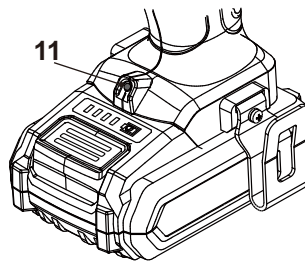

Fig. 16

In more detail...

## Switching on/off

1. Ensure the forward / reverse rotation control (6) is not on centre lock position.
2. Switch the product on by pressing the on/off switch (7) (Fig. 17).
3. Switch the product off by releasing the on/off switch (7) (Fig. 17).

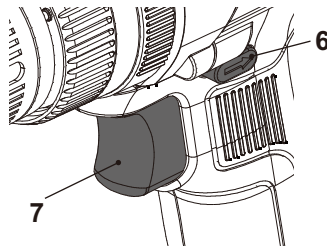

Fig. 17

## Speed control

Adjust the speed directly when operating with the built-in speed control. The on/off switch (7) of this product is combined with a speed control. The speed is controlled by how far the on/off switch is depressed.

## Belt Clip



**WARNING!** When the tool is attached to the belt, position yourself to avoid entanglement with surrounding objects.

The belt clip (9) can be assembled on the either side of the combi drill.

1. Set the forward / reverse rotation control (6) in the middle position (lock) (Fig. 10).
2. Attach the belt clip (9) to the slot and fix it with screw. (Fig. 18).
3. The belt clip (9) can be hooked on your belt or pocket, etc (Fig. 19).

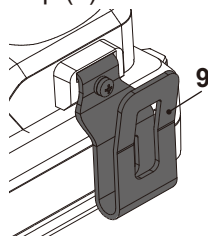

Fig. 18

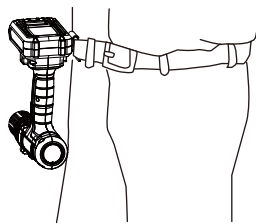

Fig. 19

## After use

1. Switch the product off, wait for complete stop, remove the battery pack and let it cool down.
2. Check, clean and store the product as described below.

## The golden rules for care



**WARNING!** Always switch the product off, remove the battery pack and let the product cool down before performing inspection, maintenance and cleaning work!



Only perform care and maintenance work according to these instructions! All further works must be performed by a qualified specialist!

1. Keep the product clean. Remove debris from it after each use and before storage.
2. Regular and proper cleaning will help ensure safe use and prolong the life of the product.
3. Inspect the product before each use for worn and damaged parts. Do not operate it if you find broken and worn parts.



**WARNING!** Only perform repairs and maintenance work according to these instructions! All further works must be performed by a qualified specialist!

## General Cleaning

1. Clean the product with a dry cloth. Use a brush for areas that are hard to reach.
2. In particular clean the air vents (5) after every use with a cloth and brush.
3. Remove stubborn dust with high pressure air (max. 3 bar).
4. Check for worn or damaged parts. Replace worn parts as necessary or contact an authorised service centre for repair before using the product again.



**NOTE:** If you have difficulties changing from one gear to another, turn the drill chuck by hand until the gears engage.

In more detail...

## Maintenance

---

Before and after each use, check the product and accessories (or attachments) for wear and damage. If required, exchange them for new ones as described in this instruction manual. Observe the technical requirements.

## Repair

---

This product does not contain any parts that can be repaired by the consumer. Contact an authorised service centre or a similarly qualified person to have it checked and repaired.

## Storage

---

1. Switch the product off and remove the battery pack (10).
2. Clean the product as described above.
3. Store the product and its accessories in a dark, dry, frost-free, well-ventilated place.
4. Always store the product in a place that is inaccessible to children. The ideal storage temperature is between 10 °C and 30 °C.
5. We recommend using the original package for storage or covering the product with a suitable cloth or enclosure to protect it against dust.

## Transportation

---

1. Switch the product off and remove the battery pack (10).
2. Attach transportation guards, if applicable.
3. Always carry the product by its handle (8).
4. Protect the product from any heavy impact or strong vibrations which may occur during transportation in vehicles.
5. Secure the product to prevent it from slipping or falling over.



## Troubleshooting

Suspected malfunctions are often due to causes that the users can fix themselves. Therefore check the product using this section. In most cases the problem can be solved quickly.



**WARNING!** Only perform the steps described within these instructions! All further inspection, maintenance and repair work must be performed by an authorised service centre or a similarly qualified specialist if you cannot solve the problem yourself!

Problem	Possible cause	Solution
1. Product does not start	1.1. Forward / reverse rotation control switch at centre lock position 1.2. Battery pack not properly attached 1.3. Battery pack discharged 1.4. Battery pack damaged 1.5. Other electrical defect to the product	1.1. Push forward / reverse rotation control switch to left / right 1.2. Attach properly 1.3. Remove and charge battery pack 1.4. Replace with a new one of the same type 1.5. Check by a specialist electrician
2. Product does not reach full power	2.1. Battery pack capacity too low 2.2. Air vents are blocked 2.3. Incorrect torque ring setting	2.1. Charge battery pack 2.2. Clean the air vents 2.3. Choose higher torque ring setting
3. Unsatisfactory result	3.1. Drill / driver bit is worn 3.2. Drill / driver bit not suitable for intended operation	3.1. Replace with a new one 3.2. Use suitable drill / driver bit
4. Product suddenly stops	4.1. Product overloaded 4.2. Battery pack discharged 4.3. Battery pack too hot	4.1. Remove the product from the workpiece and switch it on again 4.2. Remove and charge battery pack 4.3. Remove battery pack and let it cool down

In more detail...

## Recycling and disposal



Waste electrical products should not be disposed of with household waste. Please recycle where facilities exist.

Check with your Local Authority or local store for recycling advice.

**For further information visit [www.recycle-more.co.uk](http://www.recycle-more.co.uk).**

### Disposal of an exhausted battery pack



To preserve natural resources, please recycle or dispose of the battery pack properly. Consult your local waste authority for information regarding available recycling and/ or disposal options.

Discharge your battery pack by operating your tool, then remove the battery pack from the tool and cover the battery pack connections with heavy duty adhesive tape to prevent short circuit and energy discharge.

Do not attempt to open or remove any of the components.

The product comes in a package that protects it against damage during shipping. Keep the package until you are sure that all parts have been delivered and the product is working properly. Recycle the package afterwards.

## Guarantee

We take special care to select high quality materials and use manufacturing techniques that allow us to create products incorporating design and durability. This product (TITAN Cordless Combi Drill) has a manufacturer's guarantee of 2 years against manufacturing defects, from the date of purchase (if bought in store) or date of delivery (if bought online), at no additional cost.

To make a claim under this guarantee, you must present your proof of purchase (such as a sales receipt, purchase invoice or other evidence admissible under applicable law), please keep your proof of purchase in a safe place. For this guarantee to apply, the product you purchased must be new, it will not apply to second hand or display products. Unless stated otherwise by applicable law, any replacement product issued under this guarantee will only be guaranteed until expiry of the original guarantee period.

This guarantee covers product failures and malfunctions provided the product was used for the purpose for which it is intended and subject to installation, cleaning, care and maintenance in accordance with the information contained in these terms and conditions, in the user manual and standard practice, provided that standard practice does not conflict with the user manual.

This guarantee does not cover defects and damage caused by normal wear and tear or damage that could be the result of improper use, faulty installation or assembly, neglect, accident, misuse, or modification of the product. Unless stated otherwise by applicable law, this guarantee will not cover, in any case, ancillary costs (shipping, movement, costs of uninstalling and reinstalling, labour etc), or direct and indirect damage.

This guarantee does not cover defects and damage caused by or resulting from:

Normal wear and tear

Overload, misuse or neglect

Repairs attempted by anyone other than an authorised agent

Cosmetic damage

Damage caused by foreign objects, substances or accidents

Accidental damage or modification

Failure to follow manufacturer's guidelines

Loss of use of the goods



If the product is defective, we will, within a reasonable time, repair or replace it.

Rights under this guarantee are enforceable in the country in which you purchased this product. Guarantee related queries should be addressed to the store you purchased this product from.

The guarantee is in addition to and does not affect your statutory rights.

In more detail...

In more detail...

 <b>(UK) DECLARATION OF CONFORMITY</b>		
Product		
<ul style="list-style-type: none"> <li>• Cordless Combi Drill</li> <li>• TTI884COM</li> <li>• Serial number: from 000001 to 999999</li> </ul>		
Name and address of the manufacturer or his authorised representative:		
Kingfisher International Products Limited 3 Sheldon Square London W2 6PX United Kingdom		
This declaration of conformity is issued under the sole responsibility of the manufacturer.		
Object of the declaration		
Product	Model	EAN
Cordless Combi Drill	TTI884COM	
The object of the declaration described above is in conformity with the relevant legislation:		
Supply of Machinery (Safety) Regulations 2008 as amended Electromagnetic Compatibility Regulations 2016 as amended The Restriction of the use of Certain Hazardous Substances in Electrical and Electronic Equipment Regulations 2012 as amended		
References to the relevant designated standards used or references to the other technical specifications in relation to which conformity is declared:		
BS EN 62841-1:2015 BS EN 62841-2-1:2018+A11:2019 BS EN 55014-1:2017+A11 BS EN 55014-2:1997+A2 BS EN 55014-2:2015		
Authorised signatory and technical file holder: Kingfisher International Products Limited 3 Sheldon Square London W2 6PX United Kingdom		
		
David Awe Group Quality Director		On: 28/02/2022



(EN) EU DECLARATION OF CONFORMITY  
 (FR) DÉCLARATION UE DE CONFORMITÉ  
 (ES) DECLARACIÓN UE DE CONFORMIDAD  
 (PT) DECLARAÇÃO DE CONFORMIDADE UE

Product/ Produit/ Producto/Produto

- Cordless Combi Drill/Perceuse visseuse à percussion sans fil/Taladro combinado sin cable  
Berbequim combinado sem fios
- TTI884COM
- SN: 000001-999999

Name and address of the manufacturer or his authorised representative:

Nom et adresse du fabricant ou de son mandataire:

Nombre y dirección del fabricante o de su representante autorizado:

Nome e endereço do fabricante ou do respetivo mandatário:

Kingfisher International Products B.V.,  
 Rapenburgerstraat 175E,  
 1011 VM Amsterdam,  
 The Netherlands

This declaration of conformity is issued under the sole responsibility of the manufacturer.

La présente déclaration de conformité est établie sous la seule responsabilité du fabricant.

La presente declaración de conformidad se expide bajo la exclusiva responsabilidad del fabricante.

A presente declaração de conformidade é emitida sob a exclusiva responsabilidade do fabricante.

Object of the declaration/Objet de la declaration/Objeto de la declaración/Objeto da declaração

Product/Produit/Producto/ Produto

Model/Modèle/Modelo/Modelo

EAN

Cordless Combi Drill  
 Perceuse visseuse à percussion sans fil  
 Taladro combinado sin cable  
 Berbequim combinado sem fios

TTI884COM

The object of the declaration described above is in conformity with the relevant Union harmonisation legislation:

L'objet de la déclaration décrit ci-dessus est conforme à la législation d'harmonisation de l'Union applicable:

El objeto de la declaración descrita anteriormente es conforme con la legislación de armonización pertinente de la Unión:

O objeto da declaração acima descrito está em conformidade com a legislação de harmonização da União aplicável:

In more detail...

2006/42/EC as amended Machinery Directive  
 2014/30/EU as amended Directive Electromagnetic compatibility  
 2011/65/EU as amended Directive Restriction of the use of certain hazardous substances in electrical and electronic equipment

Directive 2006/42/CE relative aux machines  
 2014/30 / UE telle que modifiée Directive Compatibilité électromagnétique  
 Directive 2011/65/UE relative à la limitation de l'utilisation de certaines substances dangereuses dans les équipements électriques et électroniques

Directiva sobre maquinaria modificada 2006/42/CE  
 2014/30/UE modificada Directiva Compatibilidad electromagnética  
 2011/65/UE modificada Directiva Restricción del uso de determinadas sustancias peligrosas en equipos eléctricos y electrónicos

2006/42/CE como diretiva de máquinas alteradas  
 2014/30/UE como alteração da compatibilidade eletromagnética  
 2011/65/UE como restrição diretiva alterada da utilização de certas substâncias perigosas em equipamentos elétricos e eletrônicos

References to the relevant harmonised standards used or references to the other technical specifications in relation to which conformity is declared:

Références des normes harmonisées pertinentes appliquées, y compris la date de celles-ci, ou des autres spécifications techniques, y compris la date de celles-ci, par rapport auxquelles la conformité est déclarée:  
 Referencias a las normas armonizadas pertinentes utilizadas, incluidas las fechas de las especificaciones, respecto a las cuales se declara la conformidad:

Referências às normas harmonizadas aplicáveis utilizadas, incluindo a data da norma, ou às outras especificações técnicas, incluindo a data da especificação, em relação às quais é declarada a conformidade:

EN 62841-1:2015  
 EN 62841-2-1:2018+A11:2019  
 EN 55014-1:2017+A11  
 EN 55014-2:2015

Authorised signatory and technical file holder/signataire et responsable de la documentation technique autorisé/firmante autorizado y titular del expediente técnico/ signatário autorizado e detentor da ficha técnica

Kingfisher International Products B.V.,  
 Rapenburgerstraat 175E, 1011 VM Amsterdam, The Netherlands



David Awe  
 Group Quality Director

28/02/2022



# TITAN

**Manufacturer, Fabricant, Producent, Producător, Fabricante:**

**UK Manufacturer:**

Kingfisher International Products Limited  
3 Sheldon Square, London, W2 6PX  
United Kingdom  
[www.kingfisher.com/products](http://www.kingfisher.com/products)

**EU Manufacturer:**

Kingfisher International Products B.V.  
Rapenburgerstraat 175E  
1011 VM Amsterdam  
The Netherlands  
[www.kingfisher.com/products](http://www.kingfisher.com/products)

- EN** [www.screwfix.com](http://www.screwfix.com) [www.screwfix.ie](http://www.screwfix.ie) To view instruction manuals online, visit [www.kingfisher.com/products](http://www.kingfisher.com/products)
- FR** [www.bricodepot.fr](http://www.bricodepot.fr) Pour consulter les manuels d'instructions en ligne, rendez-vous sur le site [www.kingfisher.com/products](http://www.kingfisher.com/products)
- ES** [www.bricodepot.es](http://www.bricodepot.es) Para consultar los manuales de instrucciones en línea, visite [www.kingfisher.com/products](http://www.kingfisher.com/products)
- PT** [www.bricodepot.pt](http://www.bricodepot.pt) Para consultar manuais de instruções online, visite [www.kingfisher.com/products](http://www.kingfisher.com/products)



EN

# TITAN

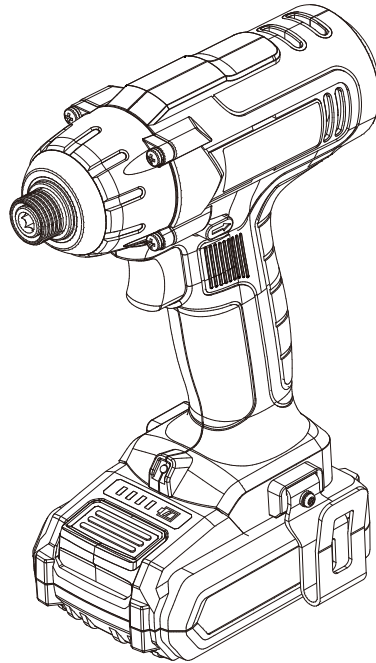

Original Instructions\_MNL\_TTI885IPD\_GB\_V01\_220308

## TTI885IPD



WARNING: Read the instructions before using the product!

V11221 / BX220IM



# Let's get started...

These instructions are for your safety. Please read through them thoroughly before use and retain them for future reference.



## Getting **started...** 02

<b>Safety</b> information	03
<b>Your</b> product	17
<b>Before</b> you <b>start</b>	19



## In more **detail...** 23

<b>Product</b> functions	24
<b>Operation</b>	27
<b>Care</b> and <b>maintenance</b>	28
<b>Troubleshooting</b>	30
<b>Recycling</b> and <b>disposal</b>	31
<b>Guarantee</b>	32
<b>Declaration of conformity</b>	33

## Safety warnings

### General power tool safety warnings



**WARNING!** Read all safety warnings, instructions, illustrations and specifications provided with this power tool. *Failure to follow all instructions listed below may result in electric shock, fire and/or serious injury.*

**Save all warnings and instructions for future reference.**

*The term “power tool” in the warnings refers to your mains-operated (corded) power tool or battery-operated (cordless) power tool.*

#### 1) Work area safety

- a) **Keep work area clean and well lit.** *Cluttered or dark areas invite accidents.*
- b) **Do not operate power tools in explosive atmospheres, such as in the presence of flammable liquids, gases or dust.** *Power tools create sparks which may ignite the dust or fumes.*
- c) **Keep children and bystanders away while operating a power tool.** *Distractions can cause you to lose control.*

#### 2) Electrical safety

- a) **Power tool plugs must match the outlet. Never modify the plug in any way. Do not use any adapter plugs with earthed (grounded) power tools.** *Unmodified plugs and matching outlets will reduce risk of electric shock.*

Getting started...

## Safety warnings

- b) **Avoid body contact with earthed or grounded surfaces, as pipes, radiators, ranges and refrigerators.** *There is an increased risk of electric shock if your body is earthed or grounded.*
  - c) **Do not expose power tools to rain or wet conditions.** *Water entering a power tool will increase the risk of electric shock.*
  - d) **Do not abuse the cord. Never use the cord for carrying, pulling or unplugging the power tool. Keep cord away from heat, oil, sharp edges or moving parts.** *Damaged or entangled cords increase the risk of electric shock.*
  - e) **When operating a power tool outdoors, use an extension cord suitable for outdoor use.** *Use of a cord suitable for outdoor use reduces the risk of electric shock.*
  - f) **If operating a power tool in a damp location is unavoidable, use a residual current device (RCD) protected supply.** *Use of an RCD reduces the risk of electric shock.*
- 3) Personal safety**
- a) **Stay alert, watch what you are doing and use common sense when operating a power tool. Do not use a power tool while you are tired or under the influence of drugs, alcohol or medication.** *A moment of inattention while operating power tools may result in serious personal injury.*
  - b) **Use personal protective equipment. Always wear eye protection.** *Protective equipment such as a dust mask, non-skid safety shoes, hard hat, or hearing protection used for appropriate conditions will reduce personal injuries.*

- c) **Prevent unintentional starting. Ensure the switch is in the off-position before connecting to power source and/or battery pack, picking up or carrying the tool.** *Carrying power tools with your finger on the switch or energising power tools that have the switch on invites accidents.*
  - d) **Remove any adjusting key or wrench before turning the power tool on.** *A wrench or a key left attached to a rotating part of the power tool may result in personal injury.*
  - e) **Do not overreach. Keep proper footing and balance at all times.** *This enables better control of the power tool in unexpected situations.*
  - f) **Dress properly. Do not wear loose clothing or jewellery. Keep your hair, clothing and gloves away from moving parts.** *Loose clothes, jewellery or long hair can be caught in moving parts.*
  - g) **If devices are provided for the connection of dust extraction and collection facilities, ensure these are connected and properly used.** *Use of dust collection can reduce dust-related hazards.*
  - h) **Do not let familiarity gained from frequent use of tools allow you to become complacent and ignore tool safety principles.** *A careless action can cause severe injury within a fraction of a second.*
- 4) Power tool use and care**
- a) **Do not force the power tool. Use the correct power tool for your application.** *The correct power tool will do the job better and safer at the rate for which it was designed.*
  - b) **Do not use the power tool if the switch does not turn it on and off.** *Any power tool that cannot be controlled with the switch is dangerous and must be repaired.*

## Safety warnings

- c) **Disconnect the plug from the power source and/ or remove the battery pack, if detachable, from the power tool before making any adjustments, changing accessories, or storing power tools.** *Such preventive safety measures reduce the risk of starting the power tool accidentally.*
- d) **Store idle power tools out of the reach of children and do not allow persons unfamiliar with the power tool or these instructions to operate the power tool.** *Power tools are dangerous in the hands of untrained users.*
- e) **Maintain power tools and accessories. Check for misalignment or binding of moving parts, breakage of parts and any other condition that may affect the power tool's operation. If damaged, have the power tool repaired before use.** *Many accidents are caused by poorly maintained power tools.*
- f) **Keep cutting tools sharp and clean.** *Properly maintained cutting tools with sharp cutting edges are less likely to bind and are easier to control.*
- g) **Use the power tool, accessories and tool bits etc. in accordance with these instructions, taking into account the working conditions and the work to be performed.** *Use of the power tool for operations different from those intended could result in a hazardous situation.*
- h) **Keep handles and grasping surfaces dry, clean and free from oil and grease.** *Slippery handles and grasping surfaces do not allow for safe handling and control of the tool in unexpected situations.*

## 5) Battery tool use and care

- a) **Recharge only with the charger specified by the manufacturer.** *A charger that is suitable for one type of battery pack may create a risk of fire when used with another battery pack.*
- b) **Use power tools only with specifically designated battery packs.** *Use of any other battery packs may create a risk of injury and fire.*
- c) **When battery pack is not in use, keep it away from other metal objects, like paper clips, coins, keys, nails, screws or other small metal objects, that can make a connection from one terminal to another.** *Shorting the battery terminals together may cause burns or a fire.*
- d) **Under abusive conditions, liquid may be ejected from the battery; avoid contact. If contact accidentally occurs, flush with water. If liquid contacts eyes, additionally seek medical help.** *Liquid ejected from the battery may cause irritation or burns.*
- e) **Do not use a battery pack or tool that is damaged or modified.** *Damaged or modified batteries may exhibit unpredictable behaviour resulting in fire, explosion or risk of injury.*
- f) **Do not expose a battery pack or tool to fire or excessive temperature.** *Exposure to fire or temperature above 130 °C may cause explosion.*
- g) **Follow all charging instructions and do not charge the battery pack or tool outside the temperature range specified in the instructions.** *Charging improperly or at temperatures outside the specified range may damage the battery and increase the risk of fire.*

## Safety warnings

### 6) Service

- a) **Have your power tool serviced by a qualified repair person using only identical replacement parts.** *This will ensure that the safety of the power tool is maintained.*
- b) **Never service damaged battery packs.** *Service of battery packs should only be performed by the manufacturer or authorized service providers.*

### Impact driver safety warnings

1. **Hold power tool by insulated gripping surfaces, when performing an operation where the fastener may contact hidden wiring.** Fastener contacting a “live” wire may make exposed metal parts of the power tool “live” and could give the operator an electric shock.

### Additional safety warnings for battery pack

- a) **Battery pack needs to be charged before use.** *Always refer to the charger’s instruction and charge it properly.*
- b) **Remove the battery pack from the product when not in use.**
- c) **Don’t maintain the battery pack on the charger when not in use.**
- d) **After extended periods of storage, it may be necessary to charge and discharge the battery pack several times to obtain the maximum performance.**
- e) **Longer life and better performance can be obtained if the battery is charged when the air temperature is between 18°C and 24°C.** *Do not charge the battery in air temperature below 5 °C or above 40 °C. This is important as it can prevent serious damage to the battery.*

- f) **Do not charge battery in a damp or wet location.** *Following this rule will reduce the risk of electric shock.*
- g) **Do not disassemble the battery and avoid mechanical damage to the battery. Risk of short circuit and fumes may be emitted.** *Ensure fresh air and seek medical assistance in the event of discomfort.*
- h) **When disposing of battery pack, keep the battery pack of different electrochemical systems separate from each other.**

**The following information applies to professional users only but is good practice for all users:**

### **ADDITIONAL SAFETY WARNING FOR CONSTRUCTION DUST**

The updated Control of Substances Hazardous to Health Regulations 1st October 2012 now also targets to reduce the risks associated with silica, wood and gypsum dusts.

Construction workers are one of the at-risk groups within this because of the dust that they breathe: silica dust is not just a nuisance; it is a real risk to your lungs!

Silica is a natural mineral present in large amounts in things like sand, sandstone and granite. It is also commonly found in many construction materials such as concrete and mortar. The silica is broken into very fine dust (also known as Respirable Crystalline Silica or RCS) during many common tasks such as cutting, drilling and grinding. Breathing in very fine particles of crystalline silica can lead to the development of:

- Lung cancer
- Silicosis
- Chronic Obstructive Pulmonary Disorder / Chronic obstructive pulmonary disease (COPD)



## Safety warnings

And breathing in fine particles of wood dust can lead to the development of Asthma. The risk of lung disease is linked to people who regularly breathe construction dust over a period of time, not on the odd occasion.

To protect the lung, the COSHH Regulations sets a limit on the amount of these dusts that you can breathe (called a Workplace Exposure Limit or WEL) when averaged over a normal working day. These limits are not a large amount of dust: when compared to a penny it is tiny – like a small pinch of salt:

This limit is the legal maximum; the most you can breathe after the right controls have been used.

### HOW TO REDUCE THE AMOUNT OF DUST?

- Reduce the amount of cutting by using the best sizes of building products.
- Use a less powerful tool e.g. a block cutter instead of angle grinder.
- Using a different method of work altogether – e.g. using a nail gun to direct fasten cable trays instead of drilling holes first.

Please always work with approved safety equipment, such as those dust masks that specially designed to filter out microscopic particles and use the dust extraction facility at all time.

For more information please see the HSE website:  
<http://www.hse.gov.uk/construction> or <http://www.hse.gov.uk/pubns/cis69.pdf>



**WARNING!** Some dust particles created by power sanding, sawing, grinding, drilling and other construction jobs contain chemicals known to cause cancer, birth defects or other reproductive harm. Some examples of these chemicals are:

- Lead from lead-based paints.
- Crystalline silica from bricks and cement and other masonry products.
- Arsenic and chromium from chemically treated timber.

Your risk from these exposures varies, depending upon how often you do this type of work. To reduce your exposure to these chemicals:

- Work in a well-ventilated area.
- Work with approved safety equipment, such as those dust masks that are specially designed to filter microscopic particles.

Getting started...

## VIBRATION

The European Physical Agents (Vibration) Directive has been brought in to help reduce hand arm vibration syndrome injuries to power tool users. The directive requires power tool manufacturers and suppliers to provide indicative vibration test results to enable users to make informed decisions as to the period of time a power tool can be used safely on a daily basis and the choice of tool.

**SEE TECHNICAL SPECIFICATIONS IN THE INSTRUCTION MANUAL FOR THE VIBRATION LEVELS OF YOUR TOOL.**

The declared vibration emission value should be used as a minimum level and should be used with the current guidance on vibration.

## Safety warnings

Calculating the actual period of use can be difficult and the HSE website has further information.

The declared vibration emission value has been measured in accordance with a standardised test and may be used to compare one tool with another.

The declared vibration emission value may also be used in a preliminary assessment of exposure.



**WARNING!** The vibration emission value during actual use of the power tool can differ from the declared value depending on the ways in which the tool is used:

- How the materials are grinded, cut or drilled.
- If the tool is in good condition and well maintained.
- Use correct accessory for the tool and ensure it is sharp and in good condition.
- The tightness of the gripping handles.
- The tool is being used as intended by its design and these instructions.

While working with this power tool, hand/arm vibrations occur. Adopt the correct working practices in order to reduce the exposure to vibration. This tool may cause hand-arm vibration syndrome if its use is not adequately managed.



**WARNING!** Identify safety measures to protect the operator that are based on an estimation of exposure in the actual conditions of use (taking account of all parts of the operating cycle such as the times when the tool is switched off and when it is running idle in addition to the trigger time).

**Note:**

- The use of other tools will reduce the users' total working period on this tool.
- Helping to minimise your vibration exposure risk. ALWAYS use sharp chisels, drills and blades.
- Maintain this tool in accordance with these instructions and keep well lubricated (where appropriate).
- Avoid using tools in temperatures of 10 °C or less. Plan your work schedule to spread any high vibration tool use across a number of days.

Getting started...

## Health surveillance

All employees should be part of an employer's health surveillance scheme to help identify any vibration related diseases at an early stage, prevent disease progression and help employees stay in work.

## Vibration and noise reduction

**To reduce the impact of noise and vibration emission, limit the time of operation, use low-vibration and low-noise operating modes as well as wear personal protective equipment.**

Take the following points into account to minimise the vibration and noise exposure risks:

- a) Only use the product as intended by its design and these instructions.
- b) Ensure that the product is in good condition and well maintained.

## Safety warnings

- c) Use correct attachments for the product and ensure they are in good condition.
- d) Keep tight grip on the handles/grip surface.
- e) Maintain this product in accordance with these instructions and keep it well lubricated (where appropriate).
- f) Plan your work schedule to spread any high vibration tool use across a longer period of time.
- g) Prolonged use of the product exposes the user to vibrations that can cause a range of conditions collectively known as hand-arm vibration syndrome (HAVS) e.g. fingers going white; as well as specific diseases such as carpal tunnel syndrome. To reduce this risk when using the product, always wear protective gloves and keep your hands warm.

### Emergency

**Familiarise yourself with the use of this product by means of this instruction manual. Memorise the safety directions and follow them to the letter. This will help to prevent risks and hazards.**

- a) **Always be alert when using this product, so that you can recognise and handle risks early.** *Fast intervention can prevent serious injury and damage to property.*
- b) **Switch the product off and remove the battery pack if there are malfunctions.** *Have the product checked by a qualified professional and repaired, if necessary, before you operate it again.*

## Residual risks

**Even if you are operating this product in accordance with all the safety requirements, potential risks of injury and damage remain. The following dangers can arise in connection with the structure and design of this product:**



- a) Health defects resulting from vibration emission if the product is being used over long periods of time or not adequately managed and properly maintained.
- b) Injuries and damage to property due to broken cutting attachments or the sudden impact of hidden objects during use.
- c) Danger of injury and property damage caused by flying objects or poor power tool accessories.



**WARNING!** This product produces an electromagnetic field during operation! This field may under some circumstances interfere with active or passive medical implants! To reduce the risk of serious or fatal injury, we recommend persons with medical implants to consult their doctor and the medical implant manufacturer before operating this product!

## Symbols

On the product, the rating label and within these instructions you will find among others the following symbols and abbreviations. Familiarise yourself with them to reduce hazards like personal injuries and damage to property.

$V \text{ ---}$	Volt, (direct current voltage)	mAh	Milliampere per hour
/min or min <sup>-1</sup>	Per minute	°C	Degree Celsius
g	Gram	kg	Kilogram
mm	Millimetre	m	Metre
cm	Centimeter	$n_0$	No-load speed
dB(A)	Decibel (A-rated)	m/s <sup>2</sup>	Metres per second squared
	Lock / to tighten or secure.		Unlock / to loosen.



Read the instruction manual.



Note / Remark.



Caution / Warning.

xxWyy Manufacturing date code; year of manufacturing (20xx) and week of manufacturing (Wyy)



Wear hearing protection.



Wear eye protection.



Wear a dust mask.



Wear protective gloves.



Wear protective, slip-resistant footwear.



Switch the product off and remove battery pack before assembly, cleaning, adjustments, maintenance, storage and transportation.



WEEE symbol. Waste electrical products should not be disposed of with household waste. Please recycle where facilities exist. Check with your Local Authority or local store for recycling advice.



Crossed out dust bin. Batteries and battery packs should not be disposed of with household waste. Please recycle where facilities exist. Check with your Local Authority or local store for recycling advice.



Do not dispose of battery packs in rivers or immerse in water.



Do not dispose of battery packs in fire. They will explode and cause injury.



Do not expose battery packs to heat in excess of 45 °C. Do not charge or store the battery pack in temperatures below 0 °C (32 °F) and above 45 °C (113°F).



The product complies with the applicable European directives and an evaluation method of conformity for these directives was done.  
UK Conformity Assessed.

## Your product

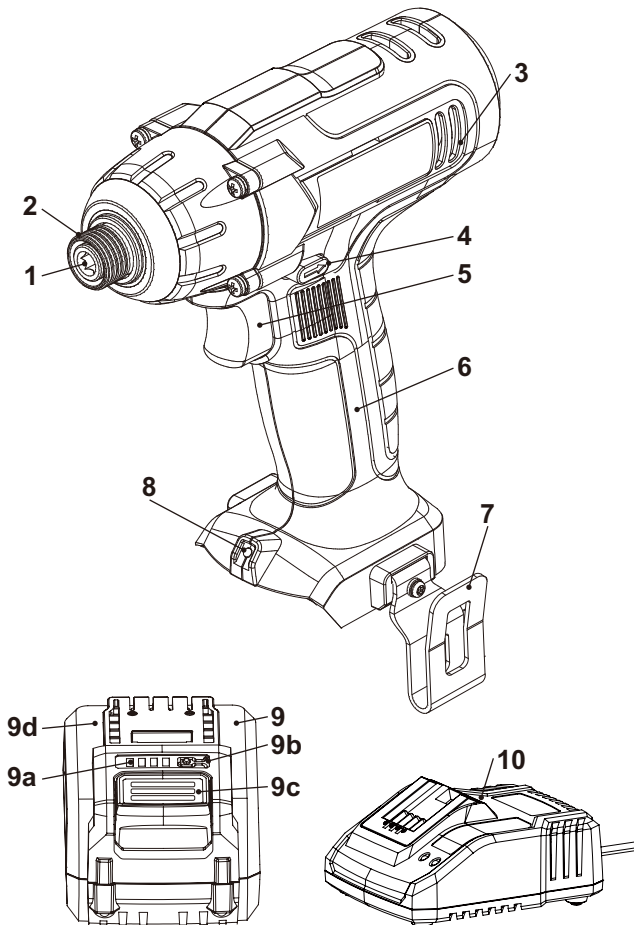

Getting started...



## Your product

- |  |                                   |                            |
|--|-----------------------------------|----------------------------|
| 1. Tool holder                           | 6. Handle                         | b) Battery capacity        |
| 2. Sleeve                                | 7. Belt clip                      | button                     |
| 3. Air vents                             | 8. Work light                     | c) Release button          |
| 4. Forward / reverse<br>rotation control | 9. Battery pack                   | d) Battery docking<br>port |
| 5. On/off switch                         | a) Battery capacity<br>indicators | 10. Charger                |



**NOTE:** Parts marked with \* are not shown in this overview. Please refer to the respective part in the instruction manual.

## Technical specifications

### General

- > **Rated voltage** : 18 V
- > **Rated no load speed  $n_0$**  : 0-2200 min<sup>-1</sup>
- > **Bit holder/ Tool socket** : Hex, 6.35mm
- > **Weight** : approx. 1.4kg  
(Including battery pack)

### Battery pack

- > **Model no.** : TTI801BAT
- > **Cell** : Li-Ion, 5 pcs
- > **Capacity** : 2000 mAh
- > **Voltage** : 18 V
- > **Weight** : approx. 0.4 kg

### Charger for battery pack

- > **Model no.** : TTB804CHR
- > **Rated output** : 21.4V d.c., 2.4 A

### Usable battery pack (sold separately)

- > **Model no.** : TTI802BAT      TTI803BAT
- > **Capacity** : 4000 mAh      5000 mAh

### Usable charger (sold separately)

- > **Model no.** : TTB805CHR
- > **Rated output** : 21.4V d.c., 4 A
- > **Ambient temperature range for charger  
and battery use** : 5 °C to 40 °C

### Sound values

- > **Sound pressure level  $L_{pA}$**  : 88.3 dB(A)
- > **Sound power level  $L_{WA}$**  : 99.3 dB(A)

- > **Uncertainty  $K_{pA}$ ,  $K_{WA}$**  : 3 dB(A)
- Hand arm vibration values**
- > **Impact tightening of fasteners of the maximum capacity of the tool  $a_h$**  : 9.06 m/s<sup>2</sup>
- > **Uncertainty K** : 1.5 m/s<sup>2</sup>

The sound intensity level for the operator may exceed 80 dB(A) and ear protection measures are necessary.

The declared vibration total values and the declared noise emission values have been measured in accordance with a standard test method (EN 62841-1 / EN 62841-2-2) and may be used for comparing one tool with another; they may also be used in a preliminary assessment of exposure.



**WARNING!** The vibration and noise emissions during actual use of the power tool can differ from the declared values depending on the ways in which the tool is used especially what kind of workpiece is processed; and need to identify safety measures to protect the operator that are based on an estimation of exposure in the actual conditions of use (taking account of all parts of the operating cycle such as the times when the tool is switched off and when it is running idle in addition to the trigger time).

Getting started...

## Rating label explanation

### TTI885IPD = Model number

TT = TITAN

I = 18V Lithium-Ion

885 = Serial Number

IPD = Cordless Impact Driver

## Unpacking

1. Unpack all parts and lay them on a flat, stable surface.
2. Remove all packing materials and shipping devices if applicable.
3. Make sure the delivery contents are complete and free of any damage. If you find that parts are missing or show damage do not use the product but contact your dealer. Using an incomplete or damaged product represents a hazard to people and property.
4. Ensure that you have all the accessories and tools needed for assembly and operation. This also includes suitable personal protective equipment.

## Unpacking



**WARNING!** The product and the packaging are not children's toys! Children must not play with plastic bags, sheets and small parts! There is a danger of choking and suffocation!

## You will need

(items not supplied)

Suitable personal protective equipment

(items supplied)

Battery pack (9)

Charger (10) and its manual



**NOTE:** The accessories required depend on the intended application. Ask your dealer for advice.

## Assembly



**WARNING!** The product must be fully assembled before operation! Do not use a product that is only partly assembled or assembled with damaged parts!



Follow the assembly instructions step-by-step and use the pictures provided as a visual guide to easily assemble the product! Do not connect the battery pack (9) to the product before it is completely assembled!

## Driver bits

Different driver bits can be used with this product depending on the screw/bolt head.



**WARNING!** Always use driver bits according to the intended use! For example, never use a slotted driver bit for crosshead screws!



Observe the technical requirements of this product (see section Technical specifications) when purchasing and using driver bits! Driver bits and screws/bolts become hot during use! Handle them carefully! Wear protective gloves when handling driver bits and screws/bolts in order to avoid injuries like burns!

### Inserting / removing / replacing

1. Pull the sleeve (2) and insert a suitable bit holder all the way to the stop into the tool holder (1). Release the sleeve (2) to lock the bit holder in place (Fig. 1).
2. Insert a suitable driver bit into the socket of the bit holder.
3. Remove the driver bit and insert a new one as described above if desired.
4. 50 mm long driver bits can be inserted directly into the tool holder (1).
5. Pull the sleeve to remove the bit holder after operation.

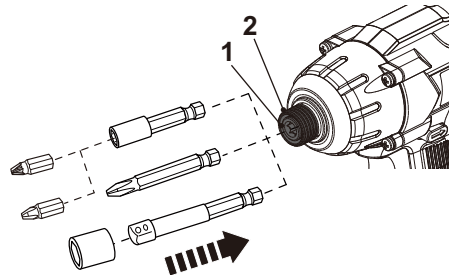

Fig. 1



**NOTE:** Always use the bit holder with 25 mm driver bits. Do not insert a 25 mm driver bit into the tool socket! If the bit holder is not inserted deep enough into the tool socket, the sleeve will not return to its initial position and the bit holder will not be secured.  
Driver bits with 50mm can be inserted directly into the tool socket.

## Battery pack

### Attaching / releasing the battery pack

1. Lock the on/off switch (5) to avoid accidental starting by moving the forward / reverse rotation control (4) into the centre position (see below section "Product functions – Forward / reverse rotation control").
2. Align the battery pack (9) with the sliding slots of the battery docking port (9d) and slide the battery pack in to attach it. Ensure it clicks in place (Fig. 2).
3. Press the release button (9c) and slide the battery pack (9) from the battery docking port (9a) (Fig. 3).

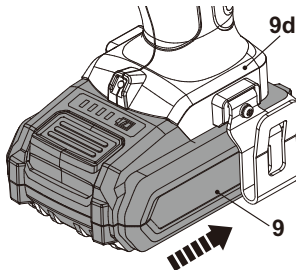

Fig. 2

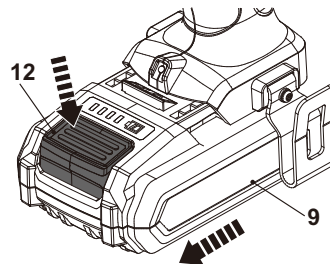

Fig. 3

Getting started...

## Charging

### Charging the battery pack

The battery pack (9) for this product has been shipped in a low charge condition. Charge it fully before first use.

Refer to the charger's instruction manual for details.

### Battery capacity indicators

The battery pack (9) is equipped with the battery capacity indicators (9a) which are used to give an indication of the battery pack's remaining capacity. Press the battery capacity button (9b) to check battery capacity (Fig. 4). The LEDs will stay lit for approximately 10 seconds.

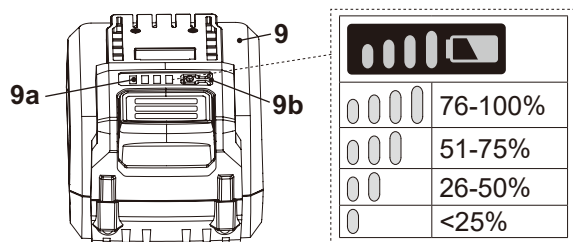

Fig. 4



## In more detail...

<b>Product functions</b>	24
<b>Operation</b>	27
<b>Care and maintenance</b>	28
<b>Troubleshooting</b>	30
<b>Recycling and disposal</b>	31
<b>Guarantee</b>	32
<b>Declaration of conformity</b>	33

In more detail....

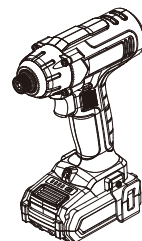

## Intended use

This product is intended for tightening and loosening screws, bolts, nuts with respective driver/hex nut driver bits. It must not be used for drilling and should not be used for working on materials that are dangerous to health. It must not be used for tightening or loosening car wheel nuts.

For safety reasons it is essential to read the entire instruction manual before first operation and to observe all the instructions therein.

It must not be used for any purposes other than those described.

## Forward / reverse rotation control

Change the rotation direction from forward to reverse by pressing the forward / reverse rotation control (4).





**WARNING!** Only change the rotational direction when the product is switched off and has come to a complete stop! Always ensure that the forward / reverse rotation control is adjusted to the correct position depending on the intended operation!

Always push the forward / reverse rotation control as far as it will go! Do not use the product with the control switch in any other position!

1. Move the forward / reverse rotation control switch (4) to the left (as seen from the operator's position) in order to use the product in a clockwise rotational mode (Fig. 5).
2. Move the forward / reverse rotation control switch (4) to the right (as seen from the operator's position) in order to use the product in anticlockwise rotational mode (Fig. 6).
3. Move the forward / reverse rotation control switch (4) to the centre position to lock the on/off switch (5) and avoid accidental starting (Fig. 7).

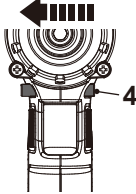
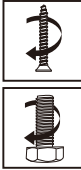
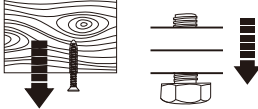
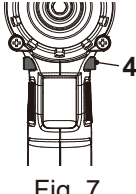
Position	Rotational direction	Application
<p>Fig. 5</p>		<p>Screw driving</p>

Position	Rotational direction	Application
 <p>Fig. 6</p>		 <p>Remove screw</p>
 <p>Fig. 7</p>		 <p>Lock the on/off switch and avoid accidental starting</p>



**NOTE:** If you are using the product for the first time after changing the rotational direction, a locking sound may be heard. This is normal and does not represent a defect.

## Automatic work light

The work light (9) automatically illuminates by pressing the on/off switch (Fig. 8).

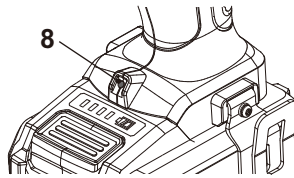

Fig. 8



**WARNING!** Do not look directly into the LED work light (8).

In more detail...



## Switching on/off

Ensure the forward / reverse rotation control (4) is not on centre lock position.

1. Switch the product on by pressing the on/off switch (5) (Fig. 9).
2. Switch the product off by releasing the on/off switch (5) (Fig. 9).

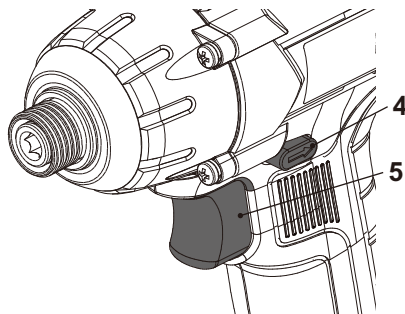

Fig. 9



**WARNING!** Never attempt to lock the on/off switch (5) in its ON position!

## Speed control

Adjust the speed directly when operating with the built-in speed control. The on/off switch (5) of this product is combined with a speed control. The speed is controlled by how far the on/off switch is depressed.

## Belt Clip



**WARNING!** When the tool is attached to the belt, position yourself to avoid entanglement with surrounding objects.

The belt clip (9) can be assembled on the either side of the combi drill.

1. Set the forward / reverse rotation control (4) in the middle position (lock) (Fig. 10).
2. Align the belt clip (9) with the slot and fix it with supplied screw. (Fig. 10).
3. The belt clip (9) can be hooked on your belt or pocket, etc (Fig. 11).

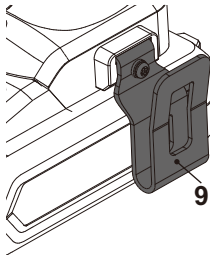

Fig. 10

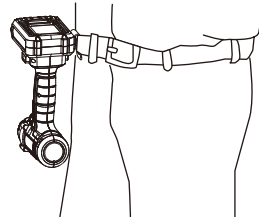

Fig. 11

## General operation

1. Check the product, its battery pack and charger as well as accessories for damage before each use. Do not use the product if it is damaged or shows wear.
2. Double check that accessories or attachments are properly fixed.
3. Always hold the product on its handle. Keep the handle dry to ensure safe support.
4. Ensure that the air vents are always unobstructed and clear. Clean them if necessary with a soft brush. Blocked air vents may lead to overheating and damage the product.
5. Switch the product off immediately if you are disturbed while working by other people entering the working area. Always let the product come to complete stop before putting it down.
6. Do not overwork yourself. Take regular breaks to ensure you can concentrate on the work and have full control over the product.



**WARNING!** Keep in mind that there are buried objects hidden in every household! Ensure that there are no gas, water or power lines hidden in the working area that may be hit before operation – danger of electrical shock and serious damage to people and property! Use a suitable detector to trace such objects in advance!

## After use

1. Switch the product off, remove the battery back and let it cool down.
2. Remove the drill bit / chisel.
3. Check, clean and store the product as described below.

In more detail...

## The golden rules for care



**WARNING!** Always switch the product off, remove the battery pack and let the product cool down before performing inspection, maintenance and cleaning work!



1. Keep the product clean. Remove debris from it after each use and before storage.
2. Regular and proper cleaning will help ensure safe use and prolong the life of the product.
3. Inspect the product before each use for worn and damaged parts. Do not operate it if you find broken and worn parts.



**WARNING!** Only perform repairs and maintenance work according to these instructions! All further works must be performed by a qualified specialist!

## General Cleaning

1. Clean the product with a dry cloth. Use a brush for areas that are hard to reach.
2. In particular clean the air vents (3) after every use with a cloth and brush.
3. Remove stubborn dust with high pressure air (max. 3 bar).

## General Cleaning



**NOTE:** Do not use chemical, alkaline, abrasive or other aggressive detergents or disinfectants to clean this product as they might be harmful to its surfaces.

4. Check for worn or damaged parts. Replace worn parts as necessary or contact an authorised service centre for repair before using the product again.

## Maintenance

Your tool requires no additional lubrication or maintenance. There are no user serviceable parts in your tool.



## Repair

---

This product does not contain any parts that can be repaired by the consumer. Contact an authorised service centre or a similarly qualified person to have it checked and repaired.

## Storage

---

1. Switch the product off and remove the battery pack.
2. Clean the product as described above.
3. Store the product and its accessories in a dark, dry, frost-free, well-ventilated place.
4. Always store the product in a place that is inaccessible to children. The ideal storage temperature is between 10 °C and 30 °C.
5. We recommend using the original package for storage or covering the product with a suitable cloth or enclosure to protect it against dust.

## Transportation

---

1. Switch the product off and remove the battery pack.
2. Attach transportation guards, if applicable.
3. Always carry the product by its handle (6).
4. Protect the product from any heavy impact or strong vibrations which may occur during transportation in vehicles.
5. Secure the product to prevent it from slipping or falling over.

## Troubleshooting

Suspected malfunctions are often due to causes that the users can fix themselves. Therefore check the product using this section. In most cases the problem can be solved quickly.



**WARNING!** Only perform the steps described within these instructions! All further inspection, maintenance and repair work must be performed by an authorised service centre or a similarly qualified specialist if you cannot solve the problem yourself!

Problem	Possible cause	Solution
1. Product does not start	1.1. Forward / reverse rotation control at centre lock position 1.2. Battery pack not properly attached 1.3. Battery pack discharged 1.4. Battery pack damaged 1.5. Other electrical defect to the product	1.1. Push forward / reverse rotation control to left or right 1.2. Attach properly 1.3. Remove and charge battery pack 1.4. Replace with a new one of the same type 1.5. Check by a specialist electrician
2. Product does not reach full power	2.1. Battery pack capacity too low 2.2. Air vents are blocked 2.3. Ambient temperature is cold	2.1. Charge battery pack 2.2. Clean the air vents 2.3. Run the product for a while to warm up.
3. Unsatisfactory result	3.1. Drill bit is worn 3.2. Drill bit not suitable for intended operation	3.1. Replace with a new one 3.2. Use suitable drill bit
4. Product suddenly stops	4.1. Product overloaded 4.2. Battery pack discharged 4.3. Battery too hot	4.1. Remove the product from the workpiece and switch it on again 4.2. Remove and charge battery pack 4.3. Remove battery pack and let it cool down
5. Excessive vibration or noise	5.1 Drill bit is dull / damaged	5.1 Replace with a new one

In more detail...

## Recycling and disposal



Waste electrical products should not be disposed of with household waste. Please recycle where facilities exist.

Check with your Local Authority or local store for recycling advice.



**For further information visit [www.recycle-more.co.uk](http://www.recycle-more.co.uk).**

The product comes in a package that protects it against damage during shipping. Keep the package until you are sure that all parts have been delivered and the product is working properly. Recycle the package afterwards.

### Disposal of an exhausted battery pack



The battery is Li-Ion type. To preserve natural resources, please recycle or dispose of the battery pack properly. Consult your local waste authority for information regarding available recycling and / or disposal options.

Discharge your battery pack by operating your tool, then remove the battery pack from the tool and cover the battery pack connections with heavy duty adhesive tape to prevent short circuit and energy discharge.

Do not attempt to open or remove any of the components.

In more detail...

## Guarantee

We take special care to select high quality materials and use manufacturing techniques that allow us to create products incorporating design and durability. This product (TITAN Cordless Impact Driver) has a manufacturer's guarantee of 2 years against manufacturing defects, from the date of purchase (if bought in store) or date of delivery (if bought online), at no additional cost.

To make a claim under this guarantee, you must present your proof of purchase (such as a sales receipt, purchase invoice or other evidence admissible under applicable law), please keep your proof of purchase in a safe place. For this guarantee to apply, the product you purchased must be new, it will not apply to second hand or display products. Unless stated otherwise by applicable law, any replacement product issued under this guarantee will only be guaranteed until expiry of the original guarantee period.

This guarantee covers product failures and malfunctions provided the product was used for the purpose for which it is intended and subject to installation, cleaning, care and maintenance in accordance with the information contained in these terms and conditions, in the user manual and standard practice, provided that standard practice does not conflict with the user manual.

This guarantee does not cover defects and damage caused by normal wear and tear or damage that could be the result of improper use, faulty installation or assembly, neglect, accident, misuse, or modification of the product. Unless stated otherwise by applicable law, this guarantee will not cover, in any case, ancillary costs (shipping, movement, costs of uninstalling and reinstalling, labour etc), or direct and indirect damage.



This guarantee does not cover defects and damage caused by or resulting from:

- Normal wear and tear
- Overload, misuse or neglect
- Repairs attempted by anyone other than an authorised agent
- Cosmetic damage
- Damage caused by foreign objects, substances or accidents
- Accidental damage or modification
- Failure to follow manufacturer's guidelines
- Loss of use of the goods

If the product is defective, we will, within a reasonable time, repair or replace it.

Rights under this guarantee are enforceable in the country in which you purchased this product. Guarantee related queries should be addressed to the store you purchased this product from.

The guarantee is in addition to and does not affect your statutory rights.

 <b>(UK) DECLARATION OF CONFORMITY</b>		
Product		
<ul style="list-style-type: none"> <li>• Cordless Impact Driver</li> <li>• TTI885IPD</li> <li>• Serial number: from 000001 to 999999</li> </ul>		
Name and address of the manufacturer or his authorised representative:		
Kingfisher International Products Limited 3 Sheldon Square London W2 6PX United Kingdom		
This declaration of conformity is issued under the sole responsibility of the manufacturer.		
Object of the declaration		
Product	Model	EAN
Cordless Impact Driver	TTI885IPD	
The object of the declaration described above is in conformity with the relevant legislation:		
Supply of Machinery (Safety) Regulations 2008 as amended Electromagnetic Compatibility Regulations 2016 as amended The Restriction of the use of Certain Hazardous Substances in Electrical and Electronic Equipment Regulations 2012 as amended		
References to the relevant designated standards used or references to the other technical specifications in relation to which conformity is declared:		
BS EN 62841-1:2015 BS EN 62841-2-2:2014 BS EN 55014-1:2017+A11 BS EN 55014-2:1997+A2 BS EN 55014-2:2015		
Authorised signatory and technical file holder: Kingfisher International Products Limited 3 Sheldon Square London W2 6PX United Kingdom		
		
David Awe Group Quality Director		On: 28/02/2022

In more detail...





(EN) EU DECLARATION OF CONFORMITY  
 (FR) DÉCLARATION UE DE CONFORMITÉ  
 (ES) DECLARACIÓN UE DE CONFORMIDAD  
 (PT) DECLARAÇÃO DE CONFORMIDADE UE

Product/ Produit/ Producto/Produto

- Cordless Impact Driver/Visseuse à choc sans fil/Atornillador de impacto inalámbrico  
Berbequim de impacto sem fios
- TTI885IPD
- SN: 000001-999999

Name and address of the manufacturer or his authorised representative:

Nom et adresse du fabricant ou de son mandataire:

Nombre y dirección del fabricante o de su representante autorizado:

Nome e endereço do fabricante ou do respetivo mandatário:

Kingfisher International Products B.V.,  
 Rapenburgerstraat 175E,  
 1011 VM Amsterdam,  
 The Netherlands

This declaration of conformity is issued under the sole responsibility of the manufacturer.

La présente déclaration de conformité est établie sous la seule responsabilité du fabricant.

La presente declaración de conformidad se expide bajo la exclusiva responsabilidad del fabricante.

A presente declaração de conformidade é emitida sob a exclusiva responsabilidade do fabricante.

Object of the declaration/Objet de la declaration/Objeto de la declaración/Objeto da declaração

Product/Produit/Producto/ Produto

Model/Modèle/Modelo/Modelo

EAN

Cordless Impact Driver  
 Visseuse à choc sans fil  
 Atornillador de impacto inalámbrico  
 Berbequim de impacto sem fios

TTI885IPD

The object of the declaration described above is in conformity with the relevant Union harmonisation legislation:

L'objet de la déclaration décrit ci-dessus est conforme à la législation d'harmonisation de l'Union applicable:

El objeto de la declaración descrita anteriormente es conforme con la legislación de armonización pertinente de la Unión:

O objeto da declaração acima descrito está em conformidade com a legislação de harmonização da União aplicável:



2006/42/EC as amended Machinery Directive  
 2014/30/EU as amended Directive Electromagnetic compatibility  
 2011/65/EU as amended Directive Restriction of the use of certain hazardous substances in electrical and electronic equipment

Directive 2006/42/CE relative aux machines  
 2014/30 / UE telle que modifiée Directive Compatibilité électromagnétique  
 Directive 2011/65/UE relative à la limitation de l'utilisation de certaines substances dangereuses dans les équipements électriques et électroniques

Directiva sobre maquinaria modificada 2006/42/CE  
 2014/30/UE modificada Directiva Compatibilidad electromagnética  
 2011/65/UE modificada Directiva Restricción del uso de determinadas sustancias peligrosas en equipos eléctricos y electrónicos

2006/42/CE como diretiva de máquinas alteradas  
 2014/30/UE como alteração da compatibilidade eletromagnética  
 2011/65/UE como restrição diretiva alterada da utilização de certas substâncias perigosas em equipamentos elétricos e eletrônicos

References to the relevant harmonised standards used or references to the other technical specifications in relation to which conformity is declared:  
 Références des normes harmonisées pertinentes appliquées, y compris la date de celles-ci, ou des autres spécifications techniques, y compris la date de celles-ci, par rapport auxquelles la conformité est déclarée:  
 Referencias a las normas armonizadas pertinentes utilizadas, incluidas las fechas de las normas, o referencias a las otras especificaciones técnicas, incluidas las fechas de las especificaciones, respecto a las cuales se declara la conformidad:  
 Referências às normas harmonizadas aplicáveis utilizadas, incluindo a data da norma, ou às outras especificações técnicas, incluindo a data da especificação, em relação às quais é declarada a conformidade:

EN 62841-1:2015  
 EN 62841-2-2:2014  
 EN 55014-1:2017+A11  
 EN 55014-2:2015

Authorised signatory and technical file holder/signataire et responsable de la documentation technique  
 autorisé/firmante autorizado y titular del expediente técnico/ signatário autorizado e detentor da ficha técnica

Kingfisher International Products B.V.,  
 Rapenburgerstraat 175E, 1011 VM Amsterdam, The Netherlands

David Awe  
 Group Quality Director

28/02/2022

In more detail...



# TITAN

Manufacturer, Fabricant, Producător, Producător, Fabricante:

**UK Manufacturer:**

Kingfisher International Products Limited  
3 Sheldon Square, London, W2 6PX  
United Kingdom  
[www.kingfisher.com/products](http://www.kingfisher.com/products)

**EU Manufacturer:**

Kingfisher International Products B.V.  
Rapenburgerstraat 175E  
1011 VM Amsterdam  
The Netherlands  
[www.kingfisher.com/products](http://www.kingfisher.com/products)

- |    |  |   |
|----|--|---|
| EN | <a href="http://www.screwfix.com">www.screwfix.com</a><br><a href="http://www.screwfix.ie">www.screwfix.ie</a> | To view instruction manuals online, visit<br><a href="http://www.kingfisher.com/products">www.kingfisher.com/products</a>                                   |
| FR | <a href="http://www.bricodepot.fr">www.bricodepot.fr</a>   | Pour consulter les manuels d'instructions en ligne,<br>rendez-vous sur le site <a href="http://www.kingfisher.com/products">www.kingfisher.com/products</a> |
| ES | <a href="http://www.bricodepot.es">www.bricodepot.es</a>   | Para consultar los manuales de instrucciones en línea,<br>visite <a href="http://www.kingfisher.com/products">www.kingfisher.com/products</a>               |
| PT | <a href="http://www.bricodepot.pt">www.bricodepot.pt</a>   | Para consultar manuais de instruções online, visite<br><a href="http://www.kingfisher.com/products">www.kingfisher.com/products</a>                         |

# **TITAN**

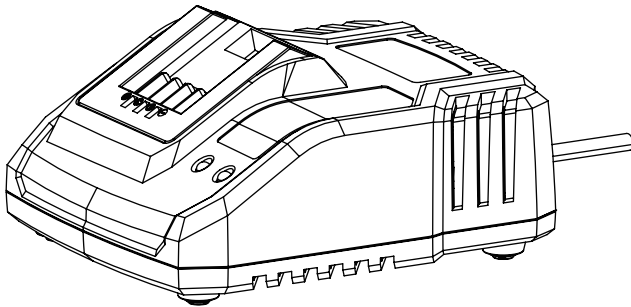



## **TTB804CHR**

**WARNING:** Read the instructions before using the product!

# Let's get started...

These instructions are for your safety. Please read through them thoroughly before use and retain them for future reference.

	<b>Getting Started...</b>	03
	Safety information	03
	Symbols	05
	Your product	06
	Technical specifications	07
	Before you start	08
	<b>In more detail...</b>	09
	Intended use	10
	Maintenance	11
	Troubleshooting	12
	Recycling and disposal	12
	Guarantee	13
	Declarations of conformity	14

## Safety warnings



**WARNING** Read all safety warnings and all instructions. Failure to follow the warnings and instructions may result in electric shock, fire and/or serious injury. Save all warnings and instructions for future reference.

This appliance can be used by children aged from 8 years and above and persons with reduced physical, sensory or mental capabilities or lack of experience and knowledge if they have been given supervision or instruction concerning use of the charger in a safe way and understand the hazards involved. Children shall not play with the appliance. Cleaning and user maintenance shall not be made by children without supervision. Charge only the battery pack specifically stated on this instruction manual.

Do not charge non-rechargeable batteries.

Disconnect the charger from the power supply and allow it to cool down before cleaning, maintenance, storage and transportation. Before using the charger, read all the instructions and cautionary markings on the charger and battery pack.

Charge the battery pack indoors only as the charger is designed for indoor use only.

Protect the charger against moisture and wet conditions. There is a danger of electric shock.

Do not place any object on top of the charger as it could cause overheating. Do not place the charger near any heat source.

When the charger is in use it **MUST** be supervised, if there is any evidence of overheating then **IMMEDIATELY** disconnect the charger from the power supply.

If gas or smoke is emitted from the battery during charging switch off the power supply and move to a well ventilated area.

Always disconnect battery charger and remove battery from charger when the charging is complete.

Do not charge a damaged battery pack.

Do not use an extension cord unless it is absolutely necessary.

The use of an improper extension cord could cause the risk of fire, electric shock or electrocution.

Do not use the charger if it has been subjected to a heavy knock, dropped or otherwise damaged in any way. Have the charger checked and repaired by an authorised service centre.

Charge the battery pack in an ambient temperature of 18 - 24°C (65 - 75°F) to ensure the longest battery life and best performance. Do not charge the battery pack in temperatures below 0°C (32°F) and above 45°C (113°F).

If the supply cord is damaged, it must be replaced by the manufacturer, its service agent or similarly qualified persons in order to avoid a hazard.

During charging, the battery must be placed in a well-ventilated area.

### **IMPORTANT NOTE**

Be sure the supply is the same as the voltage given on the rating plate for the charger. Remove the mains plug from socket before carrying out any adjustment or servicing.

## Symbols



Before charging, read the instructions



Warning



For indoor use only



This is a product of class II. This means it is equipped with an insulation reinforced or double insulation.

T 3.15A



Time lag fuse with rated current of 3.15A



WEEE symbol. Waste electrical products should not be disposed of with household waste. Please recycle where facilities exist. Check with your local authority or local store for recycling advice.

yyWxx Manufacturing date code; year of manufacturing (20yy) and week of manufacturing (Wxx)



The product complies with the applicable European directives and an evaluation method of conformity for these directives was done.



UK Conformity Assessed.



---

## Your product

---

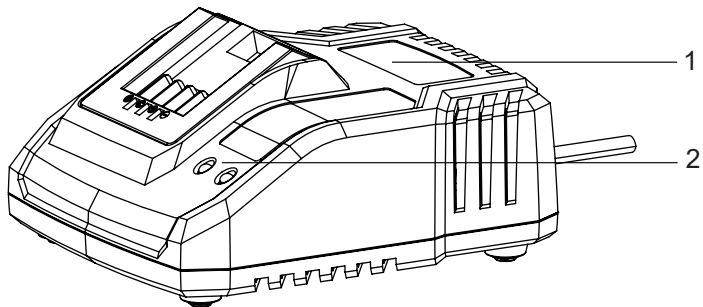

1. Charger
2. Power / charging status indicator lights

## Technical specifications

- > **Rated input** : 220 - 240 V~, 50Hz, 60 W
- > **Rated output** : 21.4V  2.4 A
- > **Protection class** : /II
- > **Weight** : Approx. 0.5 kg

For charging 18V Li-Ion battery pack as below:

Battery pack models	TTI800BAT	TTI801BAT
Rated capacity	1.5Ah	2.0Ah
Battery cells	Li-Ion,5pcs	Li-Ion,5pcs
Charging time(approx.)	50min	60min

## Before you start

### Unpacking

1. Unpack all parts and lay them on a flat, stable surface.
2. Remove all packing materials and shipping devices if applicable.
3. Make sure the delivery contents are complete and free of any damage. If you find that parts are missing or show damage do not use the product but contact your dealer. Using an incomplete or damaged product represents a hazard to people and property.



**WARNING!** The product and the packaging are not children's toys! Children must not play with plastic bags, sheets and small parts! There is a danger of choking and suffocation!

## Setup

### WALL-MOUNT HOLES

The charger has hanging holes for convenient storage. Install screws in the wall 2 inches (51 mm) apart (Fig. A). Use screws sufficiently strong to hold the combined weight of the charger and battery pack.

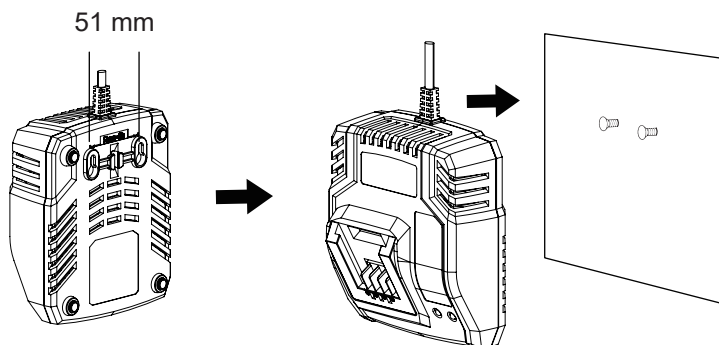
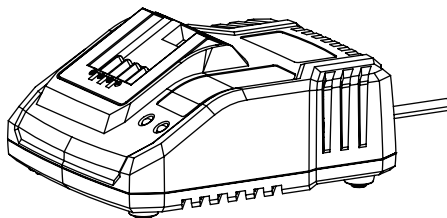

Fig. A

# In more detail...



Intended use	10
Maintenance	11
Troubleshooting	12
Recycling and disposal	12
Guarantee	13
Declarations of conformity	14



## Intended use

This charger is solely for the charging of batteries listed in the TECHNICAL SPECIFICATION section.

## Charging the battery pack



**WARNING!** The charger and battery pack are specifically designed to work together so do not attempt to use any other devices. Never insert or allow metallic objects into your charger or battery pack connections because an electrical failure and hazard will occur.



**NOTES:** If the battery pack is very hot you must remove your battery pack from the charger and allow time for the battery to cool down before recharging.

1) Insert the battery pack fully in the charger (1) (Fig. 1). Connect the charger to the power supply. The indicator lights(2) on the charger show the battery status as described in below table.

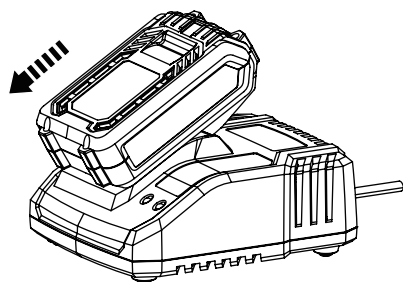

Fig. 1

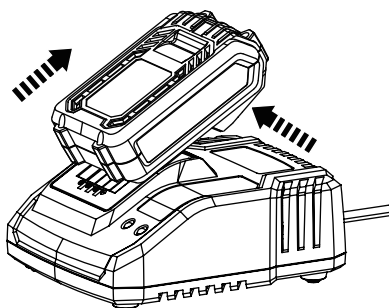

Fig. 2

Green light	RED light	Status
FLASHING	OFF	Charging
ON	OFF	Fully charged
OFF	ON	Battery temperature is too high (Charging will start automatically after cooling down).
OFF	FLASHING	Battery not in position/Defective battery

2) After charging has finished, disconnect the charger from power supply. To remove the battery pack from the charger, press the release button on the battery and pull the battery pack out of the charger (Fig.2).

**NOTE:** It is normal for the battery pack and charger to become warm (but not hot) during the charging process. Depending on temperature and existing charge level, the actual charging time may change.

The battery in your new tool is not charged when it leaves the manufacturer. Therefore, it must be fully charged before first use.

## Maintenance

**Remove the plug from the socket before carrying out any adjustment, servicing or maintenance.**

Your battery charger requires no additional lubrication or maintenance. Never use water or chemical cleaners to clean your charger. Wipe clean with a dry cloth. Always store your charger in a dry place.

If the supply cord is damaged, it must be replaced by the manufacturer, its service agent or similarly qualified persons in order to avoid a hazard.

## UK plug (only for UK market)

If you need to replace the fitted plug, then follow the instructions below.

**IMPORTANT:** The wires in the mains lead are coloured in accordance with the following code:

Blue – Neutral

Brown – Live

As the colours of the wire in the mains lead of this product may not correspond with the coloured marking identifying the terminals in your plug, proceed as follows. The wire, which is coloured blue, must be connected to the terminal which is marked with N or coloured black. The wire, which is coloured brown, must be connected to the terminal which is marked L or coloured red.

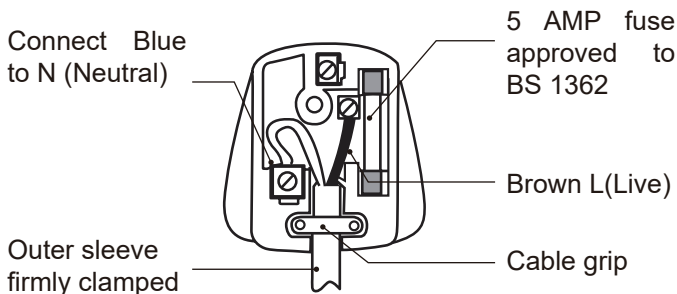

**WARNING!** Never connect live or neutral wires to the earth terminal of the plug which is marked with E.

Only fit an approved 13 Amp BS 1363 or BS 1363/A plug and the correctly rated fuse. If in doubt, consult a qualified electrician. If a moulded plug is fitted and has to be removed take great care in disposing of the plug and severed cable, it must be destroyed to prevent insertion into a socket.

## Troubleshooting

Problem	Possible cause	Solution
1. The indicator light is still off after connecting the charger to the power supply.	1.1 The charger is not well connected to the suitable power supply.	1.1 Make sure the power supply voltage is same as the charger rating label, and correctly connected.
	1.2 The charger or its cable is damaged.	1.2 Replace with new one.
2. The battery not charging.	2.1 The battery pack is hot or ambient temperature is very cold or hot.	2.1 Cool down the battery pack, and recharge at room temperature.
	2.2 The battery is not in position or damaged.	2.2 Recharge with a new charger firstly. Or insert battery fully in position, if still not charging, replace it.

## Recycling and disposal



Waste electrical products should not be disposed of with household waste. Please recycle where facilities exist. Check with your local Authority or local store for recycling advice.

## Guarantee

We take special care to select high quality materials and use manufacturing techniques that allow us to create products incorporating design and durability. This product ( TITAN Charger) has a manufacturer's guarantee of 2 years against manufacturing defects, from the date of purchase (if bought in store) or date of delivery (if bought online), at no additional cost.

To make a claim under this guarantee, you must present your proof of purchase (such as a sales receipt, purchase invoice or other evidence admissible under applicable law), please keep your proof of purchase in a safe place. For this guarantee to apply, the product you purchased must be new, it will not apply to second hand or display products. Unless stated otherwise by applicable law, any replacement product issued under this guarantee will only be guaranteed until expiry of the original guarantee period.

This guarantee covers product failures and malfunctions provided the product was used for the purpose for which it is intended and subject to installation, cleaning, care and maintenance in accordance with the information contained in these terms and conditions, in the user manual and standard practice, provided that standard practice does not conflict with the user manual.

This guarantee does not cover defects and damage caused by normal wear and tear or damage that could be the result of improper use, faulty installation or assembly, neglect, accident, misuse, or modification of the product. Unless stated otherwise by applicable law, this guarantee will not cover, in any case, ancillary costs (shipping, movement, costs of uninstalling and reinstalling, labour etc), or direct and indirect damage.

This guarantee does not cover defects and damage caused by or resulting from:

Normal wear and tear

Overload, misuse or neglect

Repairs attempted by anyone other than an authorised agent

Cosmetic damage

Damage caused by foreign objects, substances or accidents

Accidental damage or modification

Failure to follow manufacturer's guidelines

Loss of use of the goods

If the product is defective, we will, within a reasonable time, repair or replace it.

Rights under this guarantee are enforceable in the country in which you purchased this product. Guarantee related queries should be addressed to the store you purchased this product from.

The guarantee is in addition to and does not affect your statutory rights.



**(UK) DECLARATION OF CONFORMITY****Product**

- Product name – Charger
- Product model - TTB804CHR
- Type / batch or serial number range 00001 to 99999

**Name and address of the manufacturer or his authorised representative:**

Kingfisher International Products Limited  
 3 Sheldon Square  
 London W2 6PX  
 United Kingdom

This declaration of conformity is issued under the sole responsibility of the manufacturer.

**Object of the declaration**

Product	Model	EAN
Charger	TTB804CHR	

The object of the declaration described above is in conformity with the relevant legislation:

Electrical Equipment (Safety) Regulation 2016 as amended  
 Electromagnetic Compatibility Regulations 2016 as amended  
 The Restriction of the use of Certain Hazardous Substances in Electrical and Electronic Equipment Regulations 2012 as amended

References to the relevant designated standards used or references to the other technical specifications in relation to which conformity is declared:

BS EN 60335-1:2012+A2  
 BS EN 60335-2-29:2004+A11  
 BS EN 62233:2008  
 BS EN 55014-1:2017+A11  
 BS EN 55014-2:1997+A1+A2  
 BS EN 55014-2:2015  
 BS EN 61000-3-2:2014  
 BS EN IEC 61000-3-2:2019  
 BS EN 61000-3-3:2013  
 BS EN 61000-3-3:2013+A1

Signed for and on behalf of:

Kingfisher International Products Limited  
3 Sheldon Square  
London W2 6PX  
United Kingdom



David Awe  
Group Quality Director

On: 20/08/2021



(EN) EU DECLARATION OF CONFORMITY  
 (FR) DÉCLARATION UE DE CONFORMITÉ  
 (PL) DEKLARACJA ZGODNOŚCI UE  
 (RO) DECLARAȚIA DE CONFORMITATE UE  
 (ES) DECLARACIÓN UE DE CONFORMIDAD  
 (PT) DECLARAÇÃO DE CONFORMIDADE UE

Product/ Produit/ Produkt/Produsul/Producto/Produto

- Charger/Chargeur/Ładowarka/Încărcător/Cargador/Carregador
- TTB804CHR
- SN: 000001-999999

Name and address of the manufacturer or his authorised representative:

Nom et adresse du fabricant ou de son mandataire:

Nazwa i adres producenta lub jego upoważnionego przedstawiciela:

Denumirea și adresa producătorului sau a reprezentantului său autorizat:

Nombre y dirección del fabricante o de su representante autorizado:

Nome e endereço do fabricante ou do respetivo mandatário:

Kingfisher International Products B.V.,  
 Rapenburgerstraat 175E,  
 1011 VM Amsterdam,  
 The Netherlands

This declaration of conformity is issued under the sole responsibility of the manufacturer:

La présente déclaration de conformité est établie sous la seule responsabilité du fabricant:

Niniejsza deklaracja zgodności wydana zostaje na wyłączną odpowiedzialność producenta:

Declarația de conformitate este emisă pe răspunderea exclusivă a producătorului:

La presente declaración de conformidad se expide bajo la exclusiva responsabilidad del fabricante:

A presente declaração de conformidade é emitida sob a exclusiva responsabilidade do fabricante:

Object of the declaration/Objet de la déclaration/Przedmiot deklaracji/Obiectul declarației/Objeto de la declaración/Objeto da declaração

Product/Produit/Produkt/  
Produsul/Producto/ Produto

Model/Modèle/Model/  
Modelul/Modelo/Modelo

EAN

Charger  
 Chargeur  
 Ładowarka  
 Încărcător  
 Cargador  
 Carregador

TTB804CHR

The object of the declaration described above is in conformity with the relevant Union harmonisation legislation:

L'objet de la déclaration décrit ci-dessus est conforme à la législation d'harmonisation de l'Union applicable:

Wymieniony powyżej przedmiot niniejszej deklaracji jest zgodny z odpowiednimi wymaganiami unijnego prawodawstwa harmonizacyjnego:

Obiectul declarației descris mai sus este în conformitate cu legislația relevantă de armonizare a Uniunii:

El objeto de la declaración descrita anteriormente es conforme con la legislación de armonización pertinente de la Unión:

O objeto da declaração acima descrito está em conformidade com a legislação de harmonização da União aplicável:

2014/30/EU as amended Directive Electromagnetic compatibility  
 2014/35/EU Directive Electrical Safety: Low-voltage electrical equipment  
 2011/65/EU as amended Directive Restriction of the use of certain hazardous substances in electrical and electronic equipment  
 2014/30 / UE telle que modifiée Directive Compatibilit   electromagn  tique  
 2014/35/EU Directive S  curit     lectrique: mat  riel   lectrique    basse tension  
 Directive 2011/65/UE relative    la limitation de l'utilisation de certaines substances dangereuses dans les   quipements   lectriques et   lectroniques  
 2014/30 / UE ze zmianami Dyrektywa Kompatybilno  c elektromagnetyczna  
 2014/35/EU Dyrektywa bezpiecze  stwo elektryczne: sprz  t elektryczny niskiego napi  cia  
 2011/65 / UE ze zmianami Dyrektywa Ograniczenie stosowania niekt  rych niebezpiecznych substancji w sprz  cie elektrycznym i elektronicznym  
 2014/30/UE, astfel a fost modificat   Directiva privind compatibilitatea electromagnetice  
 Directiva 2014/35/UE siguran  a electric  : echipamente electrice de joas   tensiune  
 2011/65/UE, astfel a fost modificat   Directiva privind limitarea utilizarii anumitor substan  e periculoase   n echipamentele electrice   i electronice  
 2014/30/UE modificada Directiva Compatibilitad electromagn  tica  
 2014/35/EU Directiva Seguridad El  ctrica: Equipos el  ctricos de baja tensi  n  
 2011/65/UE modificada Directiva Restricci  n del uso de determinadas sustancias peligrosas en equipos el  ctricos y electr  nicos  
 2014/30/UE como altera  o da compatibilidade eletromagn  tic  
 2014/35/Diretiva UE Seguran  a El  trica: Equipamento el  trico de baixa tens  o  
 2011/65/UE como restri  o diretiva alterada da utiliza  o de certas subst  ncias perigosas em equipamentos el  tricos e eletr  nicos

References to the relevant harmonised standards used or references to the other technical specifications in relation to which conformity is declared:

R  f  rences des normes harmonis  es pertinentes appliqu  es, y compris la date de celles-ci, ou des autres specifications techniques, y compris la date de celles-ci, par rapport auxquelles la conformit   est d  clar  e:

Odwołania do odno  nych norm zharmonizowanych, kt  re zastosowano, wraz z dat   normy, lub do innych specyfikacji technicznych, wraz z dat   specyfikacji, w odniesieniu do kt  rych deklarowana jest zgodno  c:

Trimiteri la standardele armonizate relevante folosite, inclusiv data standardului, sau trimiteri la celelalte specifica  ii tehnice, inclusiv data specifica  iilor,   n leg  tur   cu care se declar   conformitatea:

Referencias a las normas armonizadas pertinentes utilizadas, incluidas las fechas de las normas, o referencias a las otras especificaciones t  cnicas, incluidas las fechas de las especificaciones, respecto a las cuales se declara la conformidad:

Refer  ncias   s normas harmonizadas aplic  veis utilizadas, incluindo a data da norma, ou   s outras especifica  es t  cnicas, incluindo a data da especifica  o, em rela  o   s quais    declarada a conformidade:

EN 60335-1:2012+A11+A13+A1+A14+A2

EN 60335-2-29: 2004+A2+A11

EN 62233: 2008

EN 55014-1:2017+A11

EN 55014-2:2015

EN IEC 61000-3-2:2019

EN 61000-3-3:2013+A1

Signed for and on behalf of/Sign   par et au nom de/Podpisano w imieniu/Semnat pentru   i   n numele/Firmado en nombre de/Assinado por e em nome de:

Kingfisher International Products B.V.,  
 Rapenburgerstraat 175E,  
 1011 VM Amsterdam,  
 The Netherlands

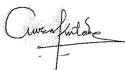

David Awe  
 Group Quality Director

20/08/2021

# TITAN

**Manufacturer, Fabricant, Producent, Producător, Fabricante:**

**UK Manufacturer:**

Kingfisher International Products Limited  
3 Sheldon Square, London, W2 6PX  
United Kingdom  
[www.kingfisher.com/products](http://www.kingfisher.com/products)

**EU Manufacturer:**

Kingfisher International Products B.V.  
Rapenburgerstraat 175E  
1011 VM Amsterdam  
The Netherlands  
[www.kingfisher.com/products](http://www.kingfisher.com/products)

- |           |  |   |
|-----------|--|---|
| <b>EN</b> | <a href="http://www.screwfix.com">www.screwfix.com</a><br><a href="http://www.screwfix.ie">www.screwfix.ie</a> | To view instruction manuals online, visit<br><a href="http://www.kingfisher.com/products">www.kingfisher.com/products</a>                                   |
| <b>FR</b> | <a href="http://www.bricodepot.fr">www.bricodepot.fr</a>   | Pour consulter les manuels d'instructions en ligne,<br>rendez-vous sur le site <a href="http://www.kingfisher.com/products">www.kingfisher.com/products</a> |
| <b>ES</b> | <a href="http://www.bricodepot.es">www.bricodepot.es</a>   | Para consultar los manuales de instrucciones en línea,<br>visite <a href="http://www.kingfisher.com/products">www.kingfisher.com/products</a>               |
| <b>PT</b> | <a href="http://www.bricodepot.pt">www.bricodepot.pt</a>   | Para consultar manuais de instruções online, visite<br><a href="http://www.kingfisher.com/products">www.kingfisher.com/products</a>                         |