



Nothing but **HEAVY DUTY.**<sup>®</sup>



# M12 FDGS

---

Original instructions



2

ø 6 mm



ø 8 mm



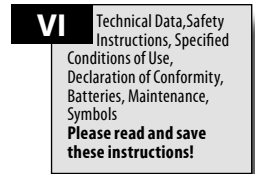
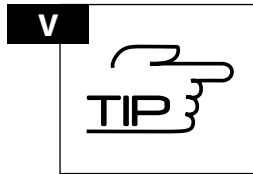
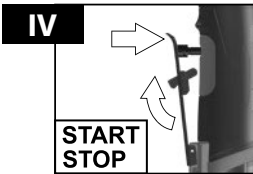
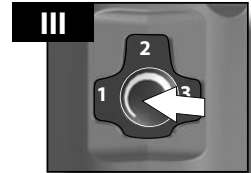
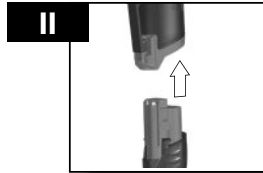
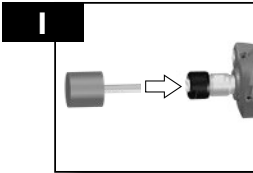

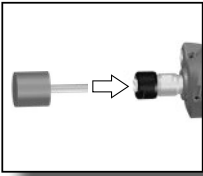

1.

$$S_{d1} = S_{d2}$$

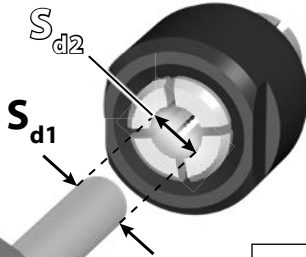
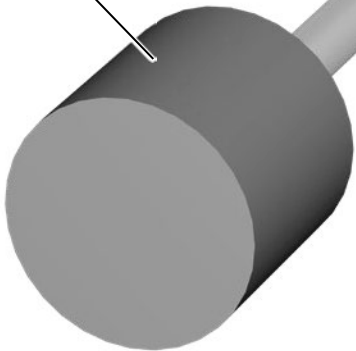
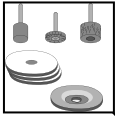

$L_3 = \text{min. } 10 \text{ mm}$

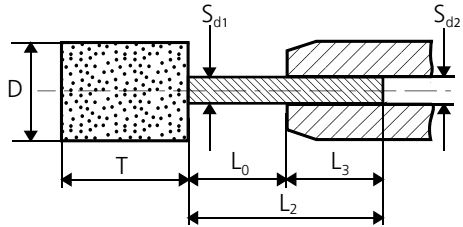

2.



3.

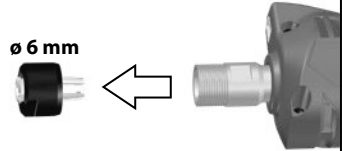

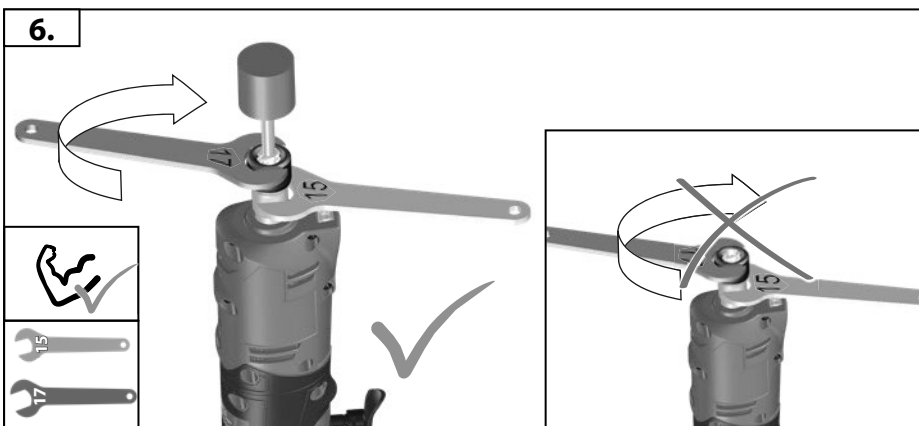
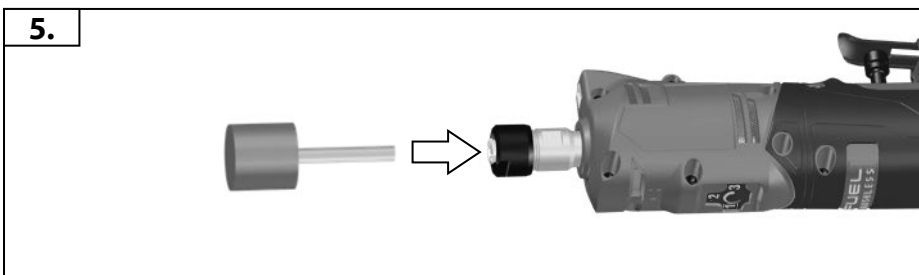
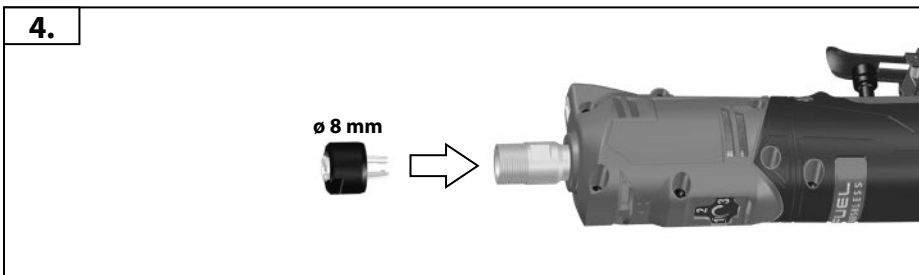
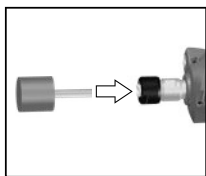

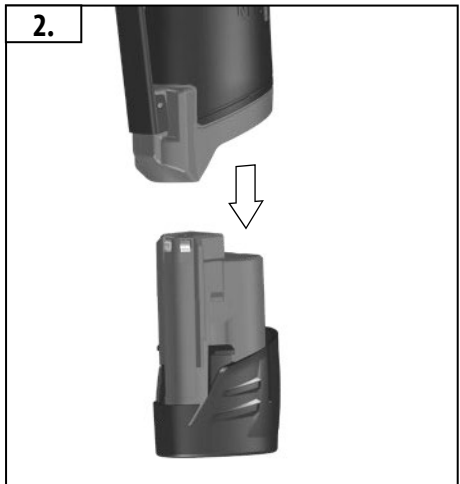
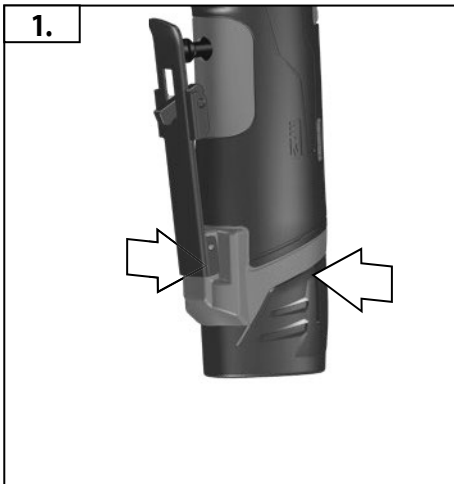
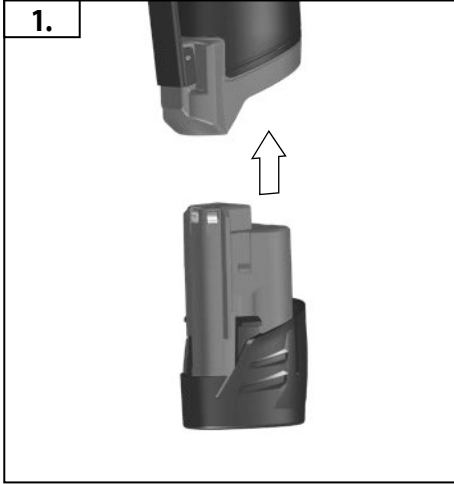
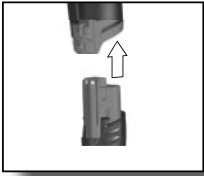

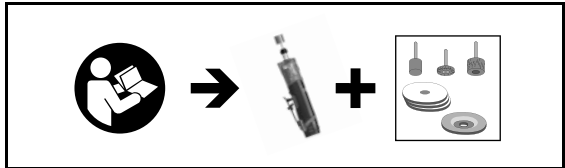

$n \leq n_{max}$ .

MODE	1	2	3
n (min <sup>-1</sup> )	0-10 000	0-15 000	0-21 000

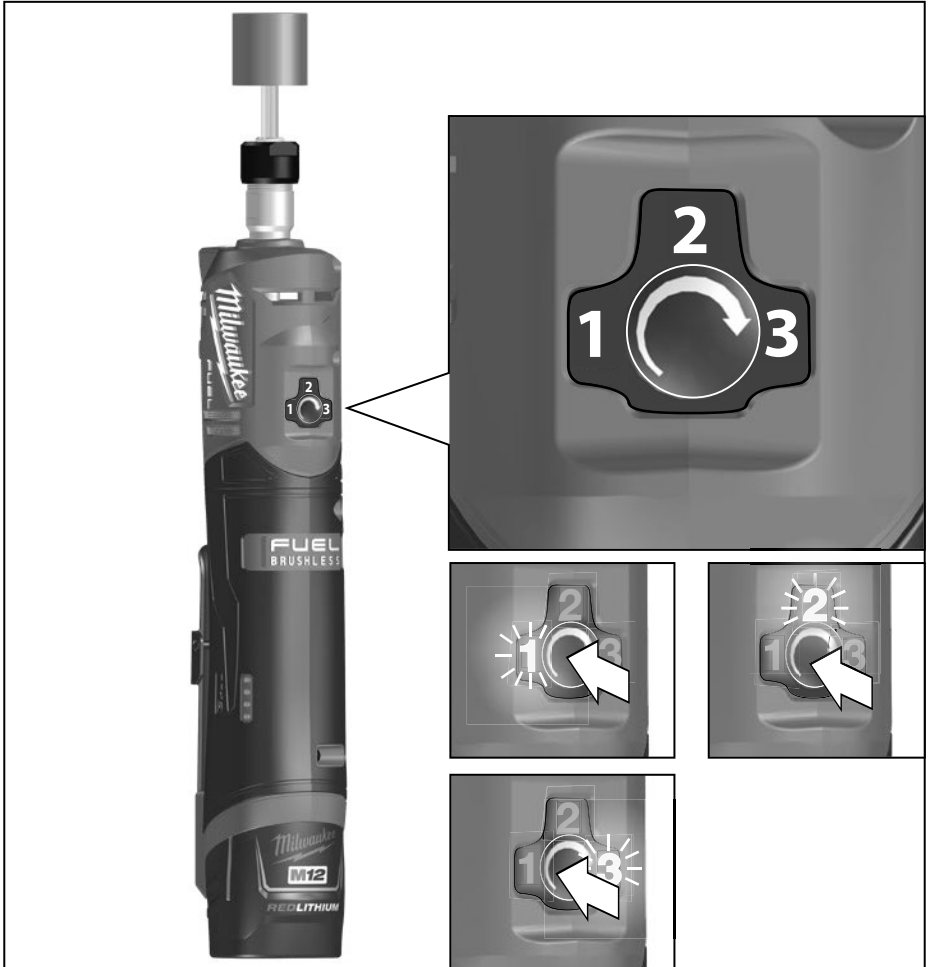

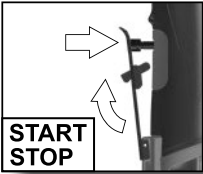



START  
STOP

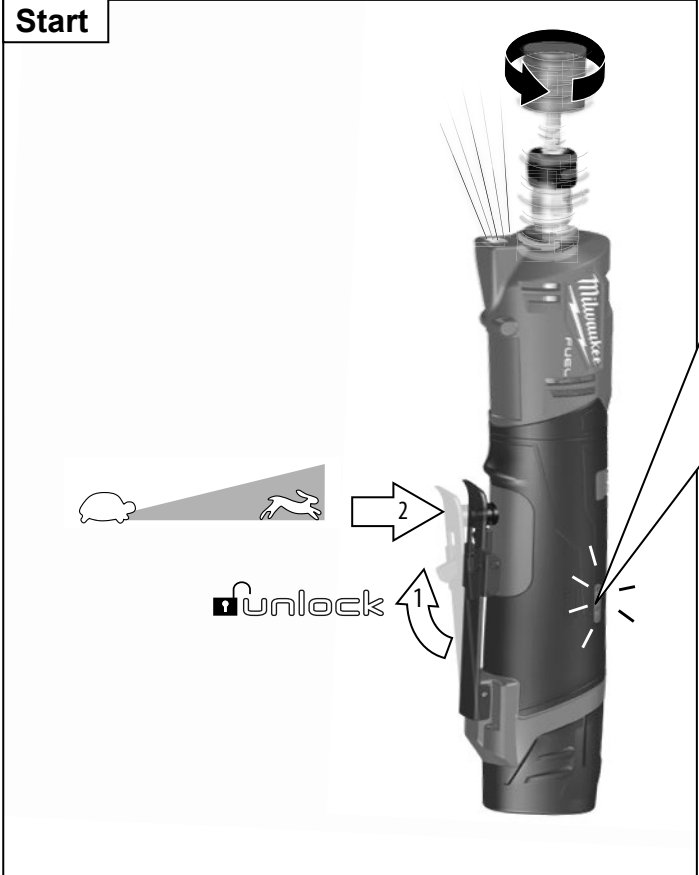

START  
STOP

Start

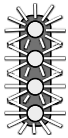
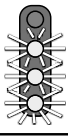
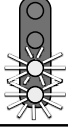
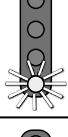
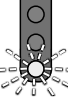

	2 sec
	100 %
	75 %
	50 %
	25 %
	<10 %

4x 





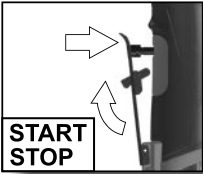

**Load-dependent motor protection:**

If the motor is overloaded, the overload protection will trip. To continue working, switch the machine off and then on again.

If the battery becomes too hot, the fuel gauge lights will flash in an alternating pattern and the tool will not run. Allow the battery to cool down.



Stop



START  
STOP

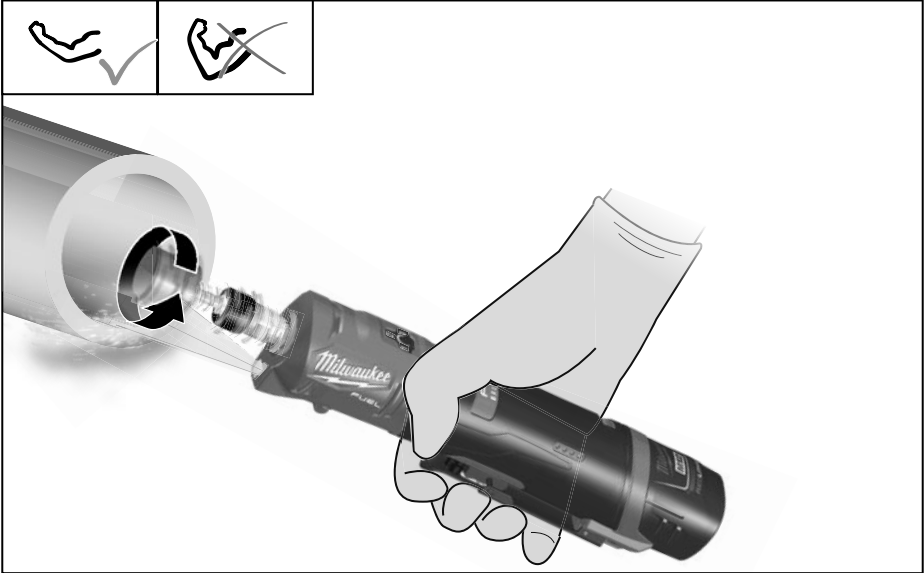
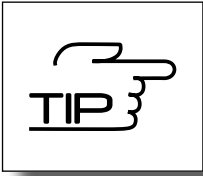

TECHNICAL DATA Fuel Straight Die Grinder	M12 FDGS
Production code	4748 00 02... ...000001-999999
Battery voltage	12 V
Rated speed 1 / 2 / 3	0-10000 / 0-15000 / 0-21000 min <sup>-1</sup>
Collet diameter	6,0 mm
Collet diameter	8,0 mm
Abrasive grinding body diameter max.	50 mm
Weight according EPTA-Procedure 01/2014 (Li-Ion 2,0 Ah...6,0 Ah)	0,7... 1,0 kg
Recommended Ambient Operating Temperature	-18°C... +50°C
Recommended battery types	M12B...
Recommended charger	C12C; M12C4; M12-18...
<b>Noise information</b>	
Measured values determined according to EN 60745. Typically, the A-weighted noise levels of the tool are	
Sound pressure level (Uncertainty K=3dB(A))	68,10 dB(A)
Sound power level (Uncertainty K=3dB(A))	79,10 dB(A)
<b>Wear ear protectors!</b>	
<b>Vibration information</b>	
Vibration total values (triaxial vector sum) determined according to EN 60745	
Vibration emission value a <sub>h</sub>	17,15 m/s <sup>2</sup>
Uncertainty K=	1,50 m/s <sup>2</sup>

For other applications, e.g. Abrasive Cutting-Off Operations or Wire Brushing other vibration values could occur.

#### WARNING!

The vibration and noise emission level given in this information sheet has been measured in accordance with a standardized test given in EN 60745 and may be used to compare one tool with another. It may be used for a preliminary assessment of exposure.

The declared vibration and noise emission level represents the main applications of the tool. However if the tool is used for different applications, with different accessories or poorly maintained, the vibration and noise emission may differ. This may significantly increase the exposure level over the total working period.

An estimation of the level of exposure to vibration and noise should also take into account the times when the tool is switched off or when it is running but not actually doing the job. This may significantly reduce the exposure level over the total working period.

Identify additional safety measures to protect the operator from the effects of vibration and/or noise such as maintain the tool and the accessories, keep the hands warm, organization of work patterns.

#### WARNING!

**Read all safety warnings and all instructions.** Failure to follow the warnings and instructions may result in electric shock, fire and/or serious injury.

**Save all warnings and instructions for future reference.**



MODE	1	2	3
n (min <sup>-1</sup> )	0-10 000	0-15 000	0-21 000



VI

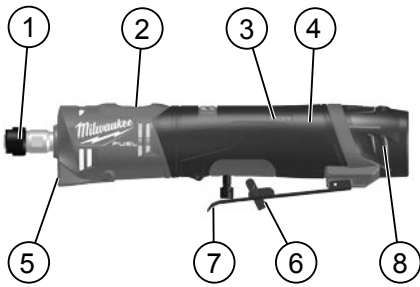

### Device description

- |                                     |                   |
|-------------------------------------|-------------------|
| ① Collet / Nut                      | ⑤ LED light       |
| ② Mode selector                     | ⑥ Switch lock-off |
| ③ Fuel gauge                        | ⑦ Paddle switch   |
| ④ Handle Insulated gripping surface | ⑧ Battery         |

### ⚠ DIE GRINDER SAFETY WARNINGS

#### Safety Warnings Common for Grinding, Sanding, Wire Brushing or Abrasive Cutting-Off Operations

- a) This power tool is intended to function as a grinder, sander, wire brush, polisher, carving or cut-off tool. Read all safety warnings, instructions, illustrations and specifications provided with this power tool.** Failure to follow all instructions listed below may result in electric shock, fire and/or serious injury.
- b) Do not use accessories which are not specifically designed and recommended by the tool manufacturer.** Just because the accessory can be attached to your power tool, it does not assure safe operation.
- c) The rated speed of the accessory must be at least equal to the maximum speed marked on the power tool.** Accessories running faster than their rated speed can break and fly apart.
- d) The outside diameter and the thickness of your accessory must be within the capacity rating of your power tool.** Incorrectly sized accessories cannot be adequately guarded or controlled.
- e) The arbour size of wheels, sanding drums or any other accessory must properly fit the spindle or collet of the power tool.** Accessories that do not match the mounting hardware of the power tool will run out of balance, vibrate excessively and may cause loss of control.
- f) Mandrel mounted wheels, sanding drums, cutters or other accessories must be fully inserted into the collet or chuck.** If the mandrel is insufficiently held and/or the overhang of the wheel is too long, the mounted wheel may become loose and be ejected at high velocity.
- g) Do not use a damaged accessory. Before each use inspect the accessory such as abrasive wheels for chips and cracks, backing pad for cracks, tear or excess wear, wire brush for loose or cracked wires. If power tool or accessory is dropped, inspect for damage or install an undamaged accessory. After inspecting and installing an accessory, position yourself and**

**bystanders away from the plane of the rotating accessory and run the power tool at maximum no-load speed for one minute.** Damaged accessories will normally break apart during this test time.

**h) Wear personal protective equipment. Depending on application, use face shield, safety goggles or safety glasses. As appropriate, wear dust mask, hearing protectors, gloves and workshop apron capable of stopping small abrasive or workpiece fragments.** The eye protection must be capable of stopping flying debris generated by various operations. The dust mask or respirator must be capable of filtering particles generated by your operation. Prolonged exposure to high intensity noise may cause hearing loss.

**i) Keep bystanders a safe distance away from work area. Anyone entering the work area must wear personal protective equipment.** Fragments of workpiece or of a broken accessory may fly away and cause injury beyond immediate area of operation.

**j) Hold the power tool by insulated gripping surfaces only, when performing an operation where the cutting accessory may contact hidden wiring.** Cutting accessory contacting a "live" wire may make exposed metal parts of the power tool "live" and could give the operator an electric shock.

**k) Always hold the tool firmly in your hand(s) during the start-up.** The reaction torque of the motor, as it accelerates to full speed, can cause the tool to twist.

**l) Use clamps to support workpiece whenever practical. Never hold a small workpiece in one hand and the tool in the other hand while in use.** Clamping a small workpiece allows you to use your hand(s) to control the tool. Round material such as dowel rods, pipes or tubing have a tendency to roll while being cut, and may cause the bit to bind or jump toward you.

**m) Never lay the power tool down until the accessory has come to a complete stop.** The spinning accessory may grab the surface and pull the power tool out of your control.

**n) After changing the bits or making any adjustments, make sure the collet nut, chuck or any other adjustment devices are securely tightened.** Loose adjustment devices can unexpectedly shift, causing loss of control, loose rotating components will be violently thrown.

**o) Do not run the power tool while carrying it at your side.** Accidental contact with the spinning accessory could snag your clothing, pulling the accessory into your body.

**p) Regularly clean the power tool's air vents.** The motor's fan will draw the dust inside the housing and excessive accumulation of powdered metal may cause electrical hazards.

**q) Do not operate the power tool near flammable materials.** Sparks could ignite these materials.

**r) Do not use accessories that require liquid coolants.** Using water or other liquid coolants may result in electrocution or shock.

#### Kickback and Related Warnings

Kickback is a sudden reaction to a pinched or snagged rotating wheel, backing pad, brush or any other accessory. Pinching or snagging causes rapid stalling of the rotating accessory which in turn causes the uncontrolled power tool to be forced in the direction opposite of the accessory's rotation at the point of the binding.

For example, if an abrasive wheel is snagged or pinched by the workpiece, the edge of the wheel that is entering into the pinch point can dig into the surface of the material causing the wheel to climb out or kick out. The wheel may either jump toward or

away from the operator, depending on direction of the wheel's movement at the point of pinching. Abrasive wheels may also break under these conditions.

Kickback is the result of power tool misuse and/or incorrect operating procedures or conditions and can be avoided by taking proper precautions as given below.

**a) Maintain a firm grip on the power tool and position your body and arm to allow you to resist kickback forces. Always use auxiliary handle, if provided, for maximum control over kickback or torque reaction during start-up.** The operator can control torque reactions or kickback forces, if proper precautions are taken.

**b) Use special care when working corners, sharp edges etc. Avoid bouncing and snagging the accessory.** Corners, sharp edges or bouncing have a tendency to snag the rotating accessory and cause loss of control or kickback.

**c) Do not attach a toothed saw blade.** Such blades create frequent kickback and loss of control.

**d) Always feed the bit into the material in the same direction as the cutting edge is exiting from the material (which is the same direction as the chips are thrown).** Feeding the tool in the wrong direction causes the cutting edge of the bit to climb out of the work and pull the tool in the direction of this feed.

**e) When using rotary files, cut-off wheels, high-speed cutters or tungsten carbide cutters, always have the work securely clamped.** These wheels will grab if they become slightly canted in the groove, and can kickback. When a cut-off wheel grabs, the wheel itself usually breaks. When a rotary file, high-speed cutter or tungsten carbide cutter grabs, it may jump from the groove and you could lose control of the tool.

#### **Safety Warnings Specific for Grinding and Abrasive Cutting-Off Operations**

**a) Use only wheel types that are recommended for your power tool and only for recommended applications. For example do not grind with the side of a cut-off wheel.** Abrasive cut-off wheels are intended for peripheral grinding, side forces applied to these wheels may cause them to shatter.

**b) For threaded abrasive cones and plugs use only undamaged wheel mandrels with an unrelieved shoulder flange that are of correct size and length.** Proper mandrels will reduce the possibility of breakage.

**c) Do not "jam" the cut-off wheel or apply excessive pressure. Do not attempt to make an excessive depth of cut.** Overstressing the wheel increases the loading and susceptibility to twisting or binding of the wheel in the cut and the possibility of kickback or wheel breakage.

**d) Do not position your hand in line with and behind the rotating wheel.** When the wheel, at the point of operation, is moving away from your hand, the possible kickback may propel the spinning wheel and the power tool directly at you.

**e) When wheel is binding or when interrupting a cut for any reason, switch off the power tool and hold the power tool motionless until the wheel comes to a complete stop. Never attempt to remove the cut-off wheel from the cut while the wheel is in motion otherwise kickback may occur.** Investigate and take corrective action to eliminate the cause of wheel binding.

**f) Do not restart the cutting operation in the workpiece. Let the wheel reach full speed and carefully re-enter the cut.** The wheel may bind, walk up or kickback if the power tool is restarted in the workpiece.

**g) Support panels or any oversized workpiece to minimize the risk of wheel pinching and kickback.** Large workpieces tend to sag under their own weight. Supports must be placed under the workpiece near the line of cut and near the edge of the workpiece on both sides of the wheel.

**h) Use extra caution when sawing into existing walls or other blind areas.** The protruding wheel may cut gas or water pipes, electrical wiring or objects that can cause kickback.

#### **Safety Warnings Specific for Sanding Operations**

**a) Do not use excessively oversized sanding disc paper. Follow manufacturers recommendations, when selecting sanding paper.** Larger sanding paper extending beyond the sanding pad presents a laceration hazard and may cause snagging, tearing of the disc or kickback.

#### **Safety Warnings Specific for Wire Brushing Operations**

**a) Be aware that wire bristles are thrown by the brush even during ordinary operation. Do not overstress the wires by applying excessive load to the brush.** The wire bristles can easily penetrate light clothing and/or skin.

**b) Allow brushes to run at operating speed for at least one minute before using them. During this time no one is to stand in front or in line with the brush.** Loose bristles or wires will be discharged during the run-in time.

**c) Direct the discharge of the spinning wire brush away from you.** Small particles and tiny wire fragments may be discharged at high velocity during the use of these brushes and may become imbedded in your skin.

#### **ADDITIONAL SAFETY AND WORKING INSTRUCTIONS**

When grinding metal, flying sparks are produced. Take care that no persons are endangered. Because of the danger of fire, no combustible materials should be located in the vicinity (spark flight zone). Do not use dust extraction.

Avoid flying sparks and sanding dust hit your body.

Only use properly fitting and undamaged open-end spanners.

The insertion tools must run completely concentric. Do not continue to use out-of-round insertion tools, instead, replace before continuing to work.

Never reach into the danger area of the machine when it is running. Chips and splinters must not be removed while the machine is running.

Immediately switch off the machine in case of considerable vibrations or if other malfunctions occur. Check the machine in order to find out the cause.

Make sure that the insertion tool comes to a complete stop before laying it down.

Under extreme conditions (e.g. smooth-grinding metals with the arbour and vulcanized fibre grinding wheel), significant contamination can build up on the inside of the die grinder.

Do not let any metal parts enter the airing slots - danger of short circuit!

Always use and store accessories according to the manufacturer's instructions.

**WARNING! Danger of burns!** The wheel and workpiece will become hot during use. Wear gloves when changing discs or touching workpiece. Keep hands away from the grinding area at all times.



**WARNING!** To reduce the risk of fire, personal injury, and product damage due to a short circuit, never immerse your tool, battery pack or charger in fluid or allow a fluid to flow inside them. Corrosive or conductive fluids, such as seawater, certain industrial chemicals, and bleach or bleach containing products, etc., can cause a short circuit.

Do not use this tool to work on asbestos-containing products. Determine the composition of the workpiece before beginning work. Asbestos should only be removed by a qualified professional.

The insertion tool must be clamped at least 10 mm. The inner shank dimension  $L_0$  can be used to calculate the maximum permitted speed of the insertion tool from the specifications provided by manufacturer of the insertion tool. It must not be less than the maximum speed of the power tool.

The workpiece must be fixed if it is not heavy enough to be steady. Never move the workpiece towards the rotating insertion tool by hand.

Remove dust and debris from the collet body and clean the insertion tool mandrel before inserting it.

Insertion tools should be protected from:

- wetness and extreme humidity
- any type of solvent
- extreme changes in temperature
- dropping and bumping

Insertion tools should be stored

- in an organized way so the insertion tools can be removed without disturbing or damaging other insertion tools
- with their safety information

Insertion tools should NOT be dropped, rolled or bumped.

Discard insertion tools that have been dropped, rolled, bumped, subjected to extreme changes in temperature, or come into contact with solvents or wetness.

Never break open battery packs and chargers and store only in dry rooms. Keep dry at all times.

Use only System M12 chargers for charging System M12 battery packs. Do not use battery packs from other systems.

#### SPECIFIED CONDITIONS OF USE

The die grinder is intended for grinding, cutting, polishing and wire brushing of wood, plastic and metal. It is ideally suited for working on hard to reach areas.

Please refer to the instructions supplied by the accessory manufacturer.

The machine is suitable only for working without water.

Do not use the product in any way other than those stated for intended use.

#### BATTERIES

Temperatures in excess of 50°C (122°F) reduce the performance of the battery pack. Avoid extended exposure to heat or sunshine (risk of overheating).

The contacts of chargers and battery packs must be kept clean.

For an optimum life-time, the battery packs have to be fully charged, after use. Battery packs which have not been used for some time should be recharged before use.

To obtain the longest possible battery life remove the battery pack from the charger once it is fully charged.

For battery pack storage longer than 30 days Store the battery pack where the temperature is below 27°C and away from moisture Store the battery packs in a 30% - 50% charged condition Every six months of storage, charge the pack as normal.

Do not dispose of used battery packs in the household refuse or by burning them. Milwaukee Distributors offer to retrieve old batteries to protect our environment.

Do not store the battery pack together with metal objects (short circuit risk).

#### BATTERY PACK PROTECTION

In extremely high torque, binding, stalling and short circuit situations that cause high current draw, the tool will stop for about 2 seconds and then the tool will turn OFF. To reset, remove the battery pack from the tool and replace it.

Under extreme circumstances, the internal temperature of the battery pack could raise too much. If this happens, the fuel gauge will flash until the battery pack cooled down. After the lights go off, the work may continue. Place the battery on the charger to charge and reset it.

#### TRANSPORTING LITHIUM BATTERIES

Lithium-ion batteries are subject to the Dangerous Goods Legislation requirements.

Transportation of those batteries has to be done in accordance with local, national and international provisions and regulations.

The user can transport the batteries by road without further requirements.

Commercial transport of Lithium-Ion batteries by third parties is subject to Dangerous Goods regulations. Transport preparation and transport are exclusively to be carried out by appropriately trained persons and the process has to be accompanied by corresponding experts.

When transporting batteries

Ensure that battery contact terminals are protected and insulated to prevent short circuit. Ensure that battery pack is secured against movement within packaging. Do not transport batteries that are cracked or leak. Check with forwarding company for further advice

#### LOAD-DEPENDENT MOTOR PROTECTION

If the battery becomes too hot, the fuel gauge lights will flash in an alternating pattern and the tool will not run. Allow the battery to cool down.

#### MAINTENANCE

Remove the battery pack before starting any work on the appliance.

The ventilation slots of the machine must be kept clear at all times.

Use only Milwaukee accessories and Milwaukee spare parts. Should components need to be replaced which have not been described, please contact one of our Milwaukee service agents (see our list of guarantee/service addresses).

If needed, an exploded view of the tool can be ordered. Please state the Article No. as well as the machine type printed on the label and order the drawing at your local service agents or directly at Techtronic Industries GmbH, Max-Eyth-Straße 10, 71364 Winnenden, Germany.



## EC-DECLARATION OF CONFORMITY

We declare under our sole responsibility that the product described under "Technical Data" fulfills all the relevant provisions of the directives

2011/65/EU (RoHS)

2006/42/EC

2014/30/EU

and the following harmonized standards have been used.

EN 60745-1:2009+A11:2010

EN 60745-2-23:2013

EN 55014-1:2017+A11:2020

EN 55014-2:2015

EN IEC 63000:2018



Winnenden, 2020-11-11

Alexander Krug / Managing Director

Authorized to compile the technical file

Techtronic Industries GmbH

Max-Eyth-Straße 10, 71364 Winnenden, Germany

## GB-DECLARATION OF CONFORMITY

We declare as the manufacturer under our sole responsibility that the product described under „Technical Data“ fulfills all the relevant provisions of the following Regulations

S.I. 2012/3032 (as amended), S.I. 2008/1597 (as amended),

S.I. 2016/1091 (as amended) and that the following designated

standards have been used:

BS EN 60745-1:2009+A11:2010

BS EN 60745-2-23:2013

BS EN 55014-1:2017+A11:2020

BS EN 55014-2:2015

BS EN IEC 63000:2018

Winnenden, 2020-11-11

Alexander Krug / Managing Director

Authorized to compile the technical file

Techtronic Industries GmbH

Max-Eyth-Straße 10, 71364 Winnenden, Germany

## SYMBOLS



CAUTION! WARNING! DANGER!



Please read the instructions carefully before starting the machine.



Always wear goggles when using the machine.



Wear gloves!



Wear a suitable dust protection mask.



Remove the battery pack before starting any work on the appliance.



Accessory - Not included in standard equipment, available as an accessory.



Rotation direction



Do not dispose electric tools, batteries/rechargeable batteries together with household waste material. Electric tools and batteries that have reached the end of their life must be collected separately and returned to an environmentally compatible recycling facility. Check with your local authority or retailer for recycling advice and collection point.

n

Rated speed

v

Voltage



Direct Current



European Conformity Mark



British Conformity Mark



Ukraine Conformity Mark



EurAsian Conformity Mark



Copyright 2020  
Techtronic Industries GmbH  
Max-Eyth-Straße 10  
71364 Winnenden  
Germany  
+49 (0) 7195-12-0  
[www.milwaukeeetool.eu](http://www.milwaukeeetool.eu)

Techtronic Industries (UK) Ltd  
Fieldhouse Lane  
Marlow Bucks SL7 1HZ  
UK



**EAC UK  
CA**

(11.20)

**4100 4255 02**