

*Please Read These Instructions
Before Using Your Mower*

Mountfield

Operating Instructions

*for models
HP185 & SP185 Lawnmowers
with B&S 300 Series engine*



Product Codes:
2L0481023/MC
2L0482023/MC

**Do not return this product to store, please call
the Service Link Helpline**

**Products with petrol in cannot be accepted
back in store**

Supported by



For all your Warranty,
Parts and Service needs

0800 121 6585

1800 806 149 ROI

www.servicelink.org.uk

Visit www.servicelink.org.uk for a quick start video

EN ENGLISH (Original instructions)	
- Safety precautions	3-4
- Know your mower	4-5
- Safety regulations	5-7
- How to get mowing	8-13
- Maintenance	13-14
- Fault Finding	14-15
GUARANTEE	16

Thank you for purchasing a Mountfield lawnmower. This machine will give you many years of safe and reliable service if operated in accordance with these instructions. **Please read and understand these Operating Instructions before using your mower. Failure to do so could result in personal injury or damage to the equipment.**



NEVER TIP THE MOWER ON ITS SIDE AS THIS WILL FLOOD THE AIR FILTER WITH OIL.
To access the underside, lift the front wheels by lowering the handle until it rests on the ground.

SAFETY PRECAUTIONS

Your lawnmower should be used with due care and attention. Symbols have therefore been placed on various parts of the machine to remind you of the main precautions to be taken. Their meaning is explained below. You are also asked to carefully read the safety regulations in the applicable chapter of this handbook



1. Warning: Read the instruction manual before operating the machine.



2. Warning! Do not put hands or feet inside the compartment of the cutting blade. Remove the spark plug cap and read the instructions before carrying out any maintenance or repair work.



3. Danger! Risk of thrown objects. Keep all persons away from the work area whilst working.

DESCRIPTION OF SYMBOLS ON CONTROLS (where foreseen)

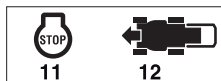

11. Engine stop 12. Drive on

IMPORTANT Any damaged or illegible decals must be replaced. Order replacement decals from a Mountfield Authorised Service Dealer.

Maximum noise and vibration levels

Operator's ear noise pressure level.....	db(A) 83
- Measurement uncertainty	db(A) 1,46
<hr/>	
Measured acoustic output level.....	db(A) 96
- Measurement uncertainty	db(A) 0,61
<hr/>	
Guaranteed acoustic output level.....	db(A) 96
<hr/>	
Vibration level	m/s 5,9
- Measurement uncertainty	m/s 1,82

IDENTIFICATION LABEL

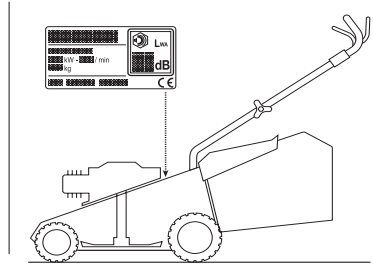
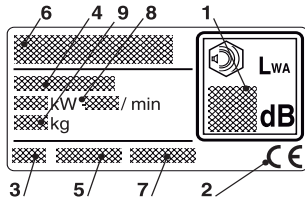

1. Sound power level
2. CE conformity marking
3. Year of manufacture
4. Type of machine
5. Serial number
6. Name and address of Manufacturer
7. Article code
8. Nominal power and maximum operating engine speed
9. Weight in kilograms

As soon as you have purchased the machine, do not forget to write the identification numbers (3-4-5-7) in the spaces on the last page of the manual.

IMPORTANT Quote the information on the product identification label whenever you contact a Mountfield Authorised Service Dealer.

IMPORTANT The example of the Declaration of Conformity is provided on the last pages of the manual.

KNOW YOUR MOWER



DESCRIPTION OF THE MACHINE AND PLANNED USE

This machine is pedestrian walk behind lawnmower.

The machine is essentially composed of a motor which drives a cutting blade enclosed in a casing, equipped with wheels and a handle.

The operator is able to operate the machine and use the main controls, always staying behind the handle at a safe distance from the rotating cutting blade.

If the operator leaves the machine, the motor and cutting blade will stop within a few seconds.

Intended use - This machine is designed and built to cut (and collect) grass in gardens and grassy areas, with a height according to its cutting capacity, driven by an operator walking behind it.

Generally speaking this machine can:

1. Mow the grass and collect it in the grass catcher.
2. Mow the grass and discharge it on the ground through the rear chute.
3. Mow the grass, cut it and discharge it on the ground (mulching plug).

Improper use

Any other usage, different to that already mentioned may be hazardous and harm persons and/or damage objects.

Examples of improper use may include, but are not limited to:

- Allowing children, animals or other passengers on the machine as they could fall off and injure themselves or compromise safe driving by the operator;
- Letting oneself be transported by the machine;
- Using the machine to tow or push loads;
- Using the cutting blade on surfaces other than grass;
- Using the machine for leaf or debris collection;
- Using the machine to trim hedges, or for cutting vegetation other than grass;
- Using of the machine by more than one person.

IMPORTANT *Improper use of the machine will invalidate the warranty, relieve the Manufacturer from all liabilities, and the user will consequently be liable for all and any damage or injury to himself or others.*

User types

This machine is intended for use by consumers, i.e. non-professional operators.

It is intended for "DIY" use only.

IMPORTANT *The machine must be used by one operator.*

SAFETY REGULATIONS

TRAINING



Become acquainted with the controls and the proper use of the machine. Learn how to stop the motor quickly. Failure to follow the warnings and instructions may result in fire and/or serious injury.

- Never allow children or persons unfamiliar with these instructions to use the machine. Local laws may establish a minimum age for users.
- Never use the machine if the user is tired or unwell, or has taken medicine, drugs, alcohol or any substances which may slow their reflexes and compromise their judgement.
- Do not allow children or other passengers to ride on the machine.
- Bear in mind that the operator or user is responsible for accidents or unexpected events occurring to other people or their property. It is the user's responsibility to assess the potential risk of the area where work is to be carried out and to take all the necessary precautions to ensure his own safety and that of others, particularly on slopes or rough, slippery and unstable ground. If the machine is sold or lent to others, make sure that the operator reads the user instructions contained in this manual.

PRELIMINARY PROCEDURES

Personal Protective Equipment (PPE)

- Always wear suitable work attire, hard-wearing safety footwear with non-slip soles and long trousers. Do not operate the machine barefoot or wearing open sandals. Wear hearing protection devices.
- Use of hearing protections can reduce the ability to hear any warnings (shouting or alarms). Be careful of what occurs around you in the work area.
- Wear protective gloves whenever your hands are at risk.
- Never wear scarves, shirts, necklaces, bracelets, loose flowing clothing, laces, ties, any hanging or flapping accessory that could catch in the machine or in any objects or materials in the work area.
- Tie your hair back if it is long.

Work area/Machine

- Thoroughly inspect the entire work area and remove anything that could be thrown by the machine or damage the cutting blade (stones, branches, iron wire, bones, etc.).

Internal combustion engine: fuel

 **DANGER!** The fuel is highly flammable.

- Keep the fuel in approved containers, in a safe place, away from any naked lights or heat sources.
- Keep the containers free of residues of grass, leaves or excessive grease.
- Keep the containers out of the reach of children.
- Do not smoke when filling up with fuel or when handling the fuel.
- Use a funnel to top up with fuel only in the open air.
- Do not inhale fuel fumes.
- Never remove the tank cap or add fuel while the engine is running or when the engine is hot.
- Open the fuel tank slowly to allow the pressure inside to decrease gradually.
- Do not approach the tank opening with a naked flame to check its contents.
- In case of fuel leakages, do not attempt to start the engine but move the machine away from the area of spillage and avoid creating any source of ignition until the fuel has evaporated and fuel vapours have dissipated.
- Immediately clean up all traces of fuel spilt on the machine or on the ground.
- Replace caps of all fuel tanks and containers securely.
- Never start the machine in the same place in which you refilled it with fuel; the engine must be started in an area at least 3 metres from where you refuelled.
- Avoid getting any fuel or your clothing and, if this should happen, change your clothes before starting the engine.

DURING OPERATION

Work Area

- Do not operate the engine in confined spaces where dangerous carbon monoxide fumes can collect. The start-up operations must be carried out outdoors or in a well-ventilated area. Always remember that the exhaust gases are toxic.
- When starting up the machine, do not direct the silencer and therefore the exhaust fumes towards flammable materials.
- Do not use the machine in environments at risk of explosion, in the presence of flammable liquids, gas or powder. Power tools create sparks which may ignite the dust or fumes.
- Work only in daylight or with good artificial light in good visibility conditions.
- Keep persons, children and animals away from the working area. Children must be supervised by another adult.
- Avoid working with wet grass, in the rain and when there is a risk of a thunderstorm, especially lightning.
- Pay careful attention to uneven ground (hills, dips), slopes, hidden hazards and obstacles that could limit visibility.
- Be very careful near ravines, ditches or embankments. The machine could overturn if a wheel slides over the edge or if the earth gives way.
- Always mow across a slope and never up and down it, being very careful when changing direction, making sure you have firm footage and that the wheels do not hit any obstacles (such as stones, branches, roots, etc.) that may cause the machine to slide sideways or make you lose control of it.
- Look out for traffic when using the machine near the road.
- To avoid the risk of fire, do not leave the machine with the engine hot on leaves or dry grass or other flammable material.

Behaviour

- Exercise caution whilst moving backwards. Look behind to ensure there are no obstacles before and during operations in reverse gear.
- Never run, always walk.
- Do not allow the lawnmower to pull you along.
- Always keep hands and feet away from the cutting blade, when starting and when using the machine.
- Attention: the cutting blade will continue to rotate for a few seconds after disengagement or after you have switched off the motor.
- Keep away from the discharge opening.
- Do not touch the parts of the engine that heat up during operation. Risk of burns.

 **If something breaks or an accident occurs during mowing, turn off the motor immediately and move the machine away to prevent further damage; if an accident occurs with injuries or third parties are injured, carry out the first aid measures most suitable for the situation immediately and contact the medical authorities for any necessary health care. Carefully remove any debris which could cause damage or injury to persons or animals if ignored.**

Use limitations

- Never operate the machine with damaged, missing or incorrectly assembled guards (grass catcher, rear discharge guards).
- Don't use the machine if the attachments/tools are not correctly fitted.
- Never disengage, deactivate, remove or tamper with the safety systems/micro switches installed.
- Do not change the engine adjustments, or exceed the maximum rpm. If the engine is forced to run at an excessive speed, the risk of personal injury increases.
- Do not strain the machine and do not use a small machine for heavy-duty work; if you use the right machine, you will reduce the risk of hazards and improve the quality of your work.

MAINTENANCE, STORAGE AND TRANSPORT

Ensure regular maintenance and correct storage to maintain machine safety and high performance levels.

Maintenance

- Never use the machine with worn or damaged parts. Faulty or worn-out parts must always be replaced and never repaired.
- To reduce the risk of fire, check for oil and/or fuel leaks on a regular basis.
- Be careful whilst adjusting the machine to prevent entrapment of the fingers between moving parts of the cutting blade and fixed parts of the machine.

The noise and vibration levels shown in these instructions are the maximum levels for use of the machine. The use of an unbalanced cutting blade, the excessive speed of movement, or the absence of maintenance have a significant influence on noise emissions and vibrations.

 **Consequently, it is necessary to take preventive steps to eliminate possible damage due to high levels of noise and stress from vibration; Maintain the machine well, wear ear protection devices, and take breaks whilst working.**

Storage

- Do not store the machine with fuel in the tank in an area where fuel vapours could reach a naked light, a spark or a strong heat source.
- To reduce fire risks, do not leave containers with debris inside a room.

ENVIRONMENTAL PROTECTION

Safeguarding the environment must be a relevant and priority aspect of machine use, of benefit to the community and the environment we live in.

- Avoid being a disturbance to the neighbourhood. Use this machine at reasonable times of the day only (not early morning or late evening when the noise could cause disturbance).
- Comply with local regulations for the disposal of packaging, deteriorated parts or any elements with a strong environmental impact; this waste must not be disposed of with regular waste, but must be separated and taken to collection centres, who will recycle the materials.
- Comply with local regulations for the disposal of waste materials.
- When the machine is withdrawn from service, do not dispose of it in the environment, but take it to a waste disposal facility in accordance with the local regulations in force.

HOW TO GET MOWING

Your Mountfield lawnmower does not contain petrol or oil and these must be added before use.

Running the mower with insufficient oil can cause serious damage to the engine and will invalidate your warranty.



NEVER TIP THE MOWER ONTO ITS SIDE AS THIS WILL FLOOD THE AIR FILTER WITH OIL.

To access the underside of the machine lift the front wheels by lowering the handle to the ground.

Carefully remove the mower from the box and read these Operating Instructions. An Owner's Manual for the engine is also included. Please read this before starting the engine.

Dispose of the box and packaging in compliance with local regulations.



WARNING - Unpacking and completing the assembly should be done on a flat and stable surface, with enough space for machine handling and its packaging, always making use of suitable equipment. Disposal of the packaging should be done in accordance with the local regulations in force

HANDLE ASSEMBLY (Figure 1)

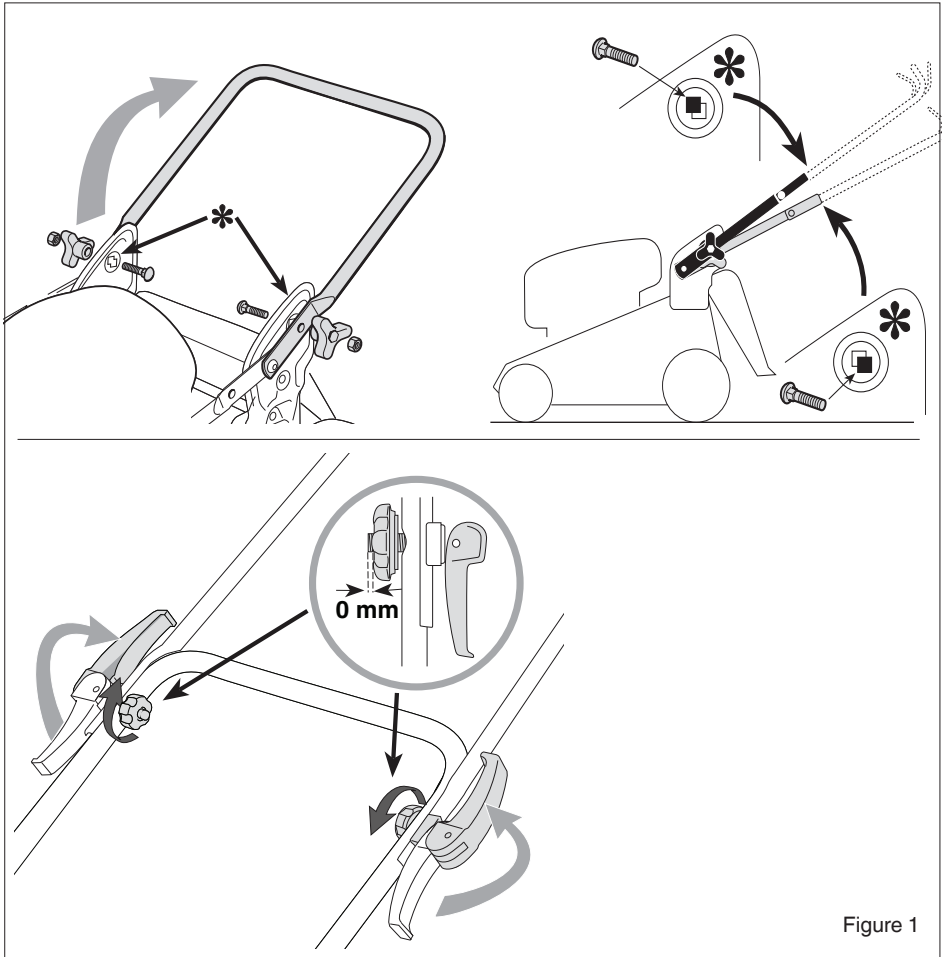
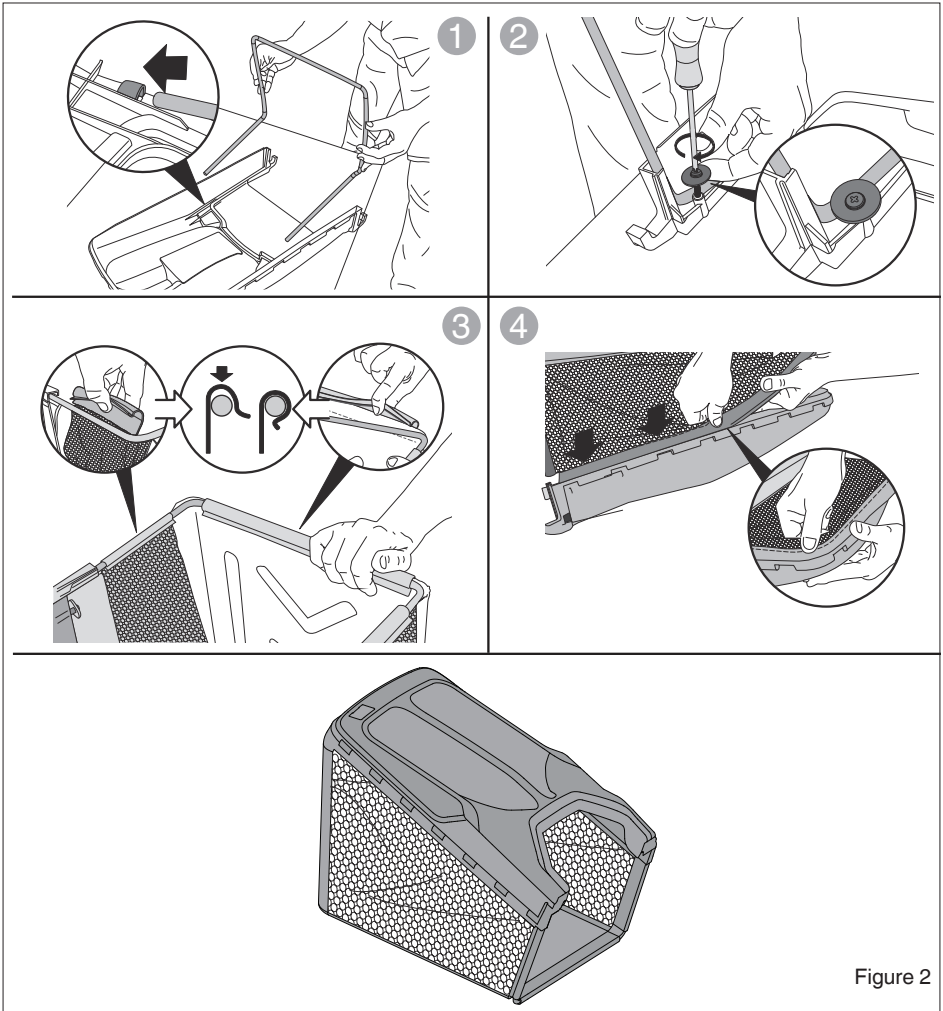

Figure 1

GRASS COLLECTOR (Figure 2)



CONTROLS

Manual start handgrip (Figure 6.A). Enables manual starting of the engine.

Figure 6

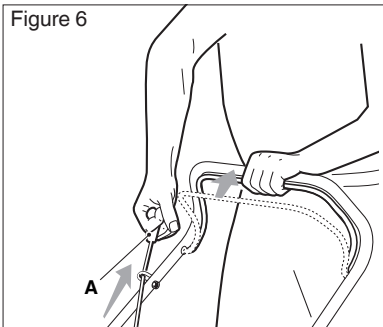

Engine brake lever / cutting blade (Figure 7.A). The lever that allows you to switch the engine on and off whilst simultaneously engaging and disengaging the cutting blade.

Drive ON lever (Figure 7.B). The lever engages the wheel drive and allows the machine to move forward. The lawnmower stops moving forward when the lever is released.

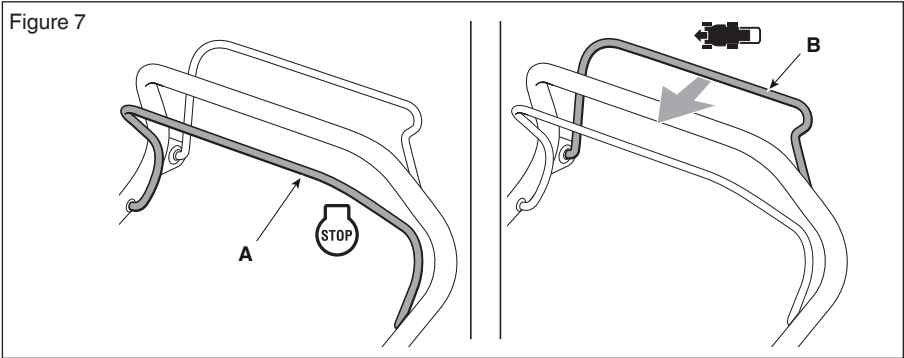

IMPORTANT The engine must always be running with the drive disengaged..

IMPORTANT To prevent damage to the transmission, do not pull the machine backwards with the drive engaged.

PRELIMINARY PROCEDURES

This machine cuts lawns in various modes; before starting work, prepare the machine based on how the lawn is to be mowed.

MAKE THIS ADJUSTMENT WHEN THE ENGINE IS OFF

Place the machine in a stable horizontal position on the ground.

a. Preparation for grass cutting and collection in the grass catcher (Figure 8.C)

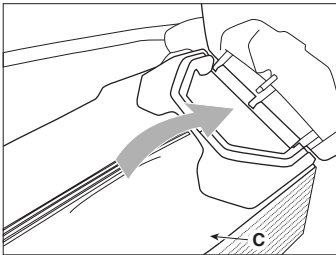

Figure 8

b. Preparation for mowing and grass rear discharge onto the ground (Figure 9)

Lift the rear discharge guard (Fig.9.A) and fit the pin (Fig.9.B).

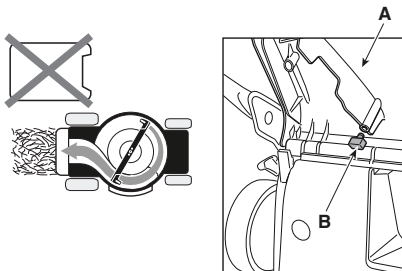

Figure 9

c. Preparation for grass mowing and mulching (Figure 10)

Lift the rear discharge guard (Fig.10.A) and fit the chute cap (Fig.10.B) in the discharge opening, keeping it slightly tilted to the right. Fasten it by fitting the two pins (Fig.10.B.1) into the holes provided until clicks into place.

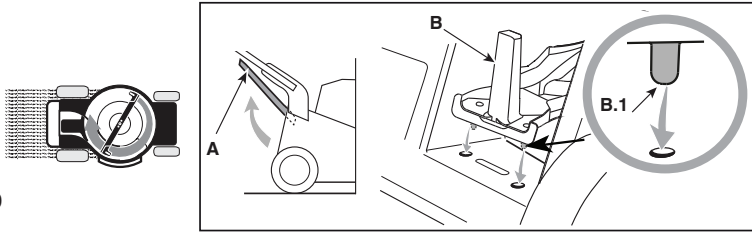

Figure 10

ADJUSTING THE HEIGHT OF CUT



Do this when the cutting blade is stationary.

The height of cut adjustment not only determines the length of the cut grass, it also controls the airflow which carries the clippings into the collector. If the discharge chute becomes blocked, increase the airflow by raising the height of cut. To prevent blockages when cutting long, thick grass, set the adjustment to the highest setting and cut the grass; then cut it again on a lower setting.

To adjust the height of cut:

- Stop the engine and disconnect the spark plug
- Put the mower on a level surface
- Adjust the cutting height by using the designated lever (Fig.11.A) that lifts or lowers the chassis to the required position.

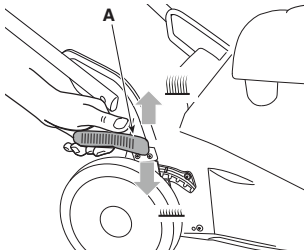

Figure 11

STARTING YOUR MOWER

Read and understand the Safety Precautions before using your mower.

- Put Mountfield 4-stroke oil, part number MX855, available from any Mountfield stockist or B&Q store, SAE 30 or 10W-30 oil, in the oil filler (Figure 12). Do not overfill. Oil tank capacity is 0,44 litre.
- Fill the fuel tank with UNLEADED petrol. Use only clean, fresh petrol - stale fuel may contain deposits that will clog the carburettor. Unleaded fuel can start to go stale after just 28 days. We recommend the use of Mountfield universal fuel stabiliser. Do not overfill, the petrol level should be below the bottom of the fuel tank neck. Do not over tighten the fuel cap. The fuel cap breathes through the threads of the cap and over tightening can cause the engine to cut out.
- Ensure that the spark plug lead is securely connected to the spark plug.
- Press the "PRIMER" device button 3 times to prime the carburettor

Figure 12

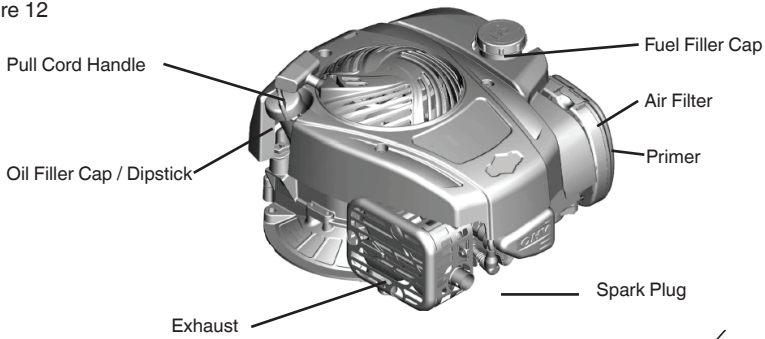

- Pull and hold the Operator Presence Control (OPC) lever against the handle to disengage the engine brake (Figure 13.A). **THE ENGINE WILL NOT START, OR CONTINUE TO RUN, UNLESS THE OPC LEVER IS HELD AGAINST THE HANDLE**
- Pull the starter cord with a strong smooth pull (Figure 13.B). Do not remove the pull cord from the guide.

NOTE Start the machine on a flat surface without obstacles or high grass.

- To engage the drive to the rear wheels on Self Propelled models, pull and hold the clutch lever against the handle.
- To stop the drive, release the clutch lever.

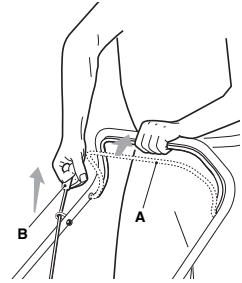

Figure 13

STOPPING YOUR MOWER

- Release the Operator Presence Control (OPC) lever; this will engage the engine brake and operate the ignition safety cut out device.



After having stopped the machine, it will take a few seconds for the cutting blade to stop.



Do not touch the engine after stopping it. Risk of burns.

IMPORTANT Always stop the machine.

- When moving between work areas.
- When driving on grass free surfaces.
- Close to an obstacle.
- Before adjusting the cutting height.
- Any time the grass catcher is removed or refitted.

IMPORTANT Any time the machine is inactive or unattended remove the spark plug cap.

BEFORE EACH USE

- Always ensure that the mower is in a safe working condition. Inspect the cutter blade for damage; check safety devices and guards; check that all nuts, bolts and screws are secure.
- Check the oil level as follows:
 - a) Remove the oil filler cap and wipe the dipstick clean (Figure 14.A).
 - b) Refit the dipstick into the filler neck, screw it down. Remove the dipstick and check the oil level; oil should be at the top of the full indicator on the dipstick (Figure 14.B). The oil tank capacity is 0,44 litre.
 - c) If the oil level is low add Mounfield oil part number MX855 or a SAE 30 or 10W-30 oil, to the top of the full indicator on the dipstick. Slowly add oil into the engine oil fill (Figure 14.C). Do not overfill.
 - d) Reinstall and tighten the dipstick.
- Fill the fuel tank with unleaded petrol. Do not overfill, there is no need to fill tank to the top. The fuel tank need only contain enough fuel to complete the days mowing. If you run out of fuel, refilling must only be carried out once the engine has cooled. Fuel stored within the machine for 28 days or more can go stale and should be drained before further use.

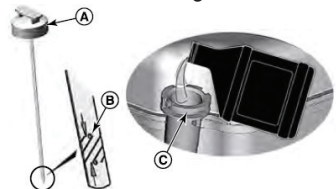

Figure 14

GRASS CUTTING

IMPORTANT When working, always keep a safe distance from the cutting means, given by the length of the handle.

For mulching or rear grass discharge: always avoid removing a large quantity of grass. Never cut more than one third of the total grass height per single pass.

Emptying the grass catcher

While working with the cutting means running, the indicator remains raised for as long as the grass catcher is able to hold cut grass; when it lowers, it means that the grass catcher is full and must be emptied.



Up = empty



Down = full

To remove and empty the grass catcher:

1. Release the engine / cutting means brake lever (Figure 15.A).
2. Wait until the cutting blade stops.
3. Lift the rear discharge guard (Figure 15.B).
4. Grasp the handle (Figure 15.C) and remove the grass catcher keeping it in an erect position (Figure 15.D).

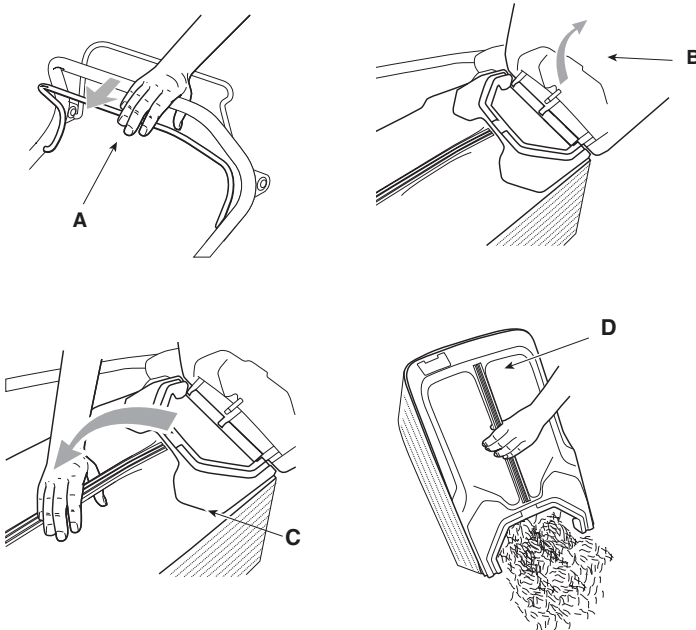

Figure 15

MAINTENANCE



Stop the engine and disconnect the spark plug lead before working on the machine.

DO NOT TIP THE MOWER ONTO ITS SIDE AS THIS WILL FLOOD THE AIR FILTER WITH OIL.

To access the underside of the machine, lift the front wheels by lowering the handle until it rests on the ground.

CUTTER BLADE

Examine the cutter blade regularly for wear or damage.

- A slightly worn blade can be re-sharpened by your local authorised Mountfield dealer
- If the blade is damaged it should be replaced. Replacement blade kits are available from your Mountfield stockist.

If in doubt refer to your authorised Mountfield dealer, or telephone 0800 121 6585 or 1800 806 149 ROI.

Blade must always be marked with part number 81004346/3.

ENGINE

An engine Manufacturer's Owner's Manual is supplied with your mower.

Please read this, it provides detailed information on engine operation, maintenance and battery care. Repair work other than routine maintenance, should be carried out by an authorised dealer.

STORAGE

A little time spent on your mower after use will ensure many years of reliable mowing.

To access the underside of the cutter deck, ensure that the spark plug lead is disconnected. Then lift the front wheels by lowering the handle until it rests on the ground. Do not tip the mower onto its side, as this will flood the air filter with oil. Failure to maintain and care for your engine may invalidate the machine guarantee. Please see the guarantee statement for full terms and conditions.

AFTER EACH USE

- Remove any grass pulp from the underside of the cutter deck using a non-metallic instrument such as a piece of wood. Take care not to damage the paintwork.
- Examine the cutter blade for any damage. A damaged blade may upset the balance of your mower and cause excessive vibration. If in doubt refer to your dealer.
- Inspect the grass collector and clean it if necessary. If the mesh becomes clogged airflow will be reduced and impair grass collection.
- The handle can be folded down to reduce the amount of storage space required. Take care not to trap any of the operating cables when folding or unfolding the handle.
- Store the mower in a clean, dry area well away from children's reach, any naked flames, sparks or heat source. Make sure that keys or tools used for maintenance are removed

LONG TERM - (if you are not using your mower for more than 28 days)

- Give the machine a thorough clean, paying particular attention to the underside
- Lubricate all moving parts
- Empty the fuel tank by running the mower out of fuel

HANDLING AND TRANSPORTATION

Whenever the machine is to be handled, raised, transported or tilted you must:

- Stop the machine until the moving parts come to a complete halt.
- Remove the spark plug cap.
- Wear heavy work gloves.
- Hold the machine in the points offering a safe grip, taking into account the weight and its division.
- Use an appropriate number of people for the weight of the machine and the characteristics of the vehicle or the place where it must be placed or collected.
- Make sure that machine movements do not cause damage or injuries.

When transporting the machine on a vehicle or trailer, always:

- Use an access ramp of suitable strength, width and length.
- Load the machine with the motor switched off and pushed by an adequate number of people.
- Lower the cutting blade assembly.
- Position it so that it cannot cause a hazard for anybody.
- Fasten firmly to the device of transport using ropes or chains to prevent it from tipping over causing damage and fuel leaks.

FAULT FINDING

PROBLEM	SOLUTION
Engine will not start	Check there is ample clean, fresh fuel in the tank. Any stale fuel needs to be drained from the machine.
	Check the cutter blade is not fouling the ground preventing free rotation.
	Check the petrol filler cap isn't on too tightly - it should only be finger tight.
Engine will not stop	Check the Operator Presence Control (OPC) lever is fully released.
	Remove spark plug lead to stop the engine using insulated gloves and refer to dealer.
Engine smokes	Engine may be overfilled with oil or may have been tipped.
Engine running unevenly	Check the petrol filler cap isn't too tight - it should only be finger tight. If fuel is over 28 days old it has gone stale and will need replacing.
Failure to cut grass properly	Stop the engine and disconnect the spark plug lead using heat resistant gloves.
	Check blade attachment bolt is tight.
	Check condition of blade. If seriously worn or damaged replace with a new one.

Failure to collect grass properly	Stop the engine and disconnect the spark plug lead using heat resistant gloves.
	Check and make sure there is no build up of grass inside the casing.
	Check grass collector is allowing air to flow through the fabric. If it is clogged it should be washed carefully.
	If the grass collector is not clogged raise the height of cut to increase airflow.
	Check to ensure the engine is running at the correct speed (approximately 3,000rpm)
Machine vibrates excessively	If conditions are too severe to use the grass collector, remove it and work with the deflector in position.
	This will certainly indicate that the blade has become badly damaged. Stop the engine, disconnect the spark plug lead and examine the blade assembly. Refer to your local dealer.



SERVICE LINK
HELPLINE
0800 121 6585
1800 806 149 801
or visit
www.servicelink.org.uk

This product is supported by Service Link. If you have been unable to find the information you require above please call the Service Link helpline. Here you will find 1-2-1 help and advice from garden machinery repair specialists.



Service link

- > **What is Service Link?** Service Link is an aftersales help and advice helpline with a national network of garden machinery repair specialists.
- > **How can we help you?** Here at Service Link we can help with all your trouble shooting, warranty, parts and service needs. Call us and speak to one of our advisors and if required, visit one of our 450 centres across the UK and Ireland.
- > **How can you contact us?** If in the unlikely event that this product does require our help, please visit the Service Link website at www.servicelink.org.uk or alternatively contact the helpline on 0800 121 6585 in the UK or 1800806149 in ROI.

CERTIFICATE OF CONFORMITY

A certificate of conformity is enclosed with the documentation as separate document. **AN EXAMPLE is here on the bottom.**

DICHIARAZIONE CE DI CONFORMITÀ (Istruzioni Originali)
(Diretiva Macchine 2006/42/CE, Allegato II, parte A)

1. La Società: **ST S.p.A.** – Via del Lavoro, 6 – 31033 Castelfranco Veneto (TV) – Italy

Dichiaro sotto la propria responsabilità, che la macchina: **Tosarba con conduttore a piedi / taglio erba**

a) Tipo / Modello Base: **ST S34**

b) Meccanismo di costruzione

c) Matricola

d) Motore: a scoppio

3. E' conforme alle specifiche delle direttive:

- MD: 2006/42/CE
- e) Etichetta Certificatore: /
- f) Esame CE del tipo: /
- OND: 2009/142/CE, ANNESSI VI - 2005/88/CE
- g) Etichetta CE di tipo: /
- h) Etichetta Certificatore: /
- EMC: 2014/53/UE
- RoHS II: 2011/65/UE - 2015/863/UE

4. Riferimento alle Norme armonizzate:

EN ISO 5395-1:2013+A1:2019
EN ISO 5395-2:2013+A1:2016+A2:2017
EN ISO 8541:2012

g) Livello di potenza sonora
h) Livello di potenza acustica
i) Ampiezza di taglio

Personia autorizzata a compilare il Documento CE di Conformità: **ST S.p.A.**
Via del Lavoro, 6
31033 Castelfranco Veneto (TV) - Italia

g) Castelfranco Veneto, il 09.09.2019

CEO Rigpa Group
Sean Robinson

Sean Robinson

FR (Traduzione de la notice originale)	EN (Translation of the original document)	DE (Übersetzung der Originaldokumentation)
<p>EC Declaration of Conformity Dichiarazione di Conformità, Annesso II, parte A</p> <p>1. La Società 1.1. La Società che è propria responsabilità quella di dichiarare "Tosarba a piedi a conduttore a piedi" con motore a scoppio</p> <p>1.2. Modelli di base 1.3. Modelli di base di costruzione 1.4. Motori 1.5. Motori con autorizzazione CE 1.6. Caratteristiche tecniche 1.7. Organismo di certificazione 1.8. Norme CE di tipo 1.9. Norme armonizzate 1.10. Norme di armonizzazione armonizzate 1.11. Livello di potenza sonora 1.12. Livello di potenza acustica 1.13. Ampiezza di taglio</p> <p>2. Dichiaro sotto la propria responsabilità che la macchina "Tosarba a piedi a conduttore a piedi" con motore a scoppio è conforme alle specifiche delle direttive:</p> <ul style="list-style-type: none"> - MD: 2006/42/CE e) Etichetta Certificatore: / f) Esame CE del tipo: / - OND: 2009/142/CE, ANNESSI VI - 2005/88/CE g) Etichetta CE di tipo: / h) Etichetta Certificatore: / - EMC: 2014/53/UE - RoHS II: 2011/65/UE - 2015/863/UE <p>3. Riferimento alle Norme armonizzate:</p> <p>EN ISO 5395-1:2013+A1:2019 EN ISO 5395-2:2013+A1:2016+A2:2017 EN ISO 8541:2012</p> <p>g) Livello di potenza sonora h) Livello di potenza acustica i) Ampiezza di taglio</p> <p>Personia autorizzata a compilare il Documento CE di Conformità: ST S.p.A. Via del Lavoro, 6 31033 Castelfranco Veneto (TV) - Italia</p> <p>g) Castelfranco Veneto, il 09.09.2019</p> <p>CEO Rigpa Group Sean Robinson</p>	<p>EC Declaration of Conformity Dichiarazione di Conformità, Annesso II, parte A</p> <p>1. The Company 1.1. The Company which is its own responsibility to declare "Tosarba a piedi a conduttore a piedi" with spark engine</p> <p>1.2. Base Model 1.3. Base Model of construction 1.4. Motor 1.5. Motor with CE authorization 1.6. Technical specifications 1.7. CE certification body 1.8. CE type standards 1.9. Harmonized standards 1.10. CE type standards 1.11. Sound power level 1.12. Sound power level 1.13. Cutting width</p> <p>2. I declare under my responsibility that the Technical Document "Tosarba a piedi a conduttore a piedi" with spark engine complies with the Technical Document</p> <p>3. This product complies with the requirements of the following Directives:</p> <ul style="list-style-type: none"> - MD: 2006/42/EC e) CE Certificate Label: / f) CE type examination: / - OND: 2009/142/EC, ANNEXES VI - 2005/88/EC g) CE type label: / h) CE Certificate Label: / - EMC: 2014/53/EU - RoHS II: 2011/65/EU - 2015/863/EU <p>4. Reference to the Harmonized Standards:</p> <p>EN ISO 5395-1:2013+A1:2019 EN ISO 5395-2:2013+A1:2016+A2:2017 EN ISO 8541:2012</p> <p>g) Sound power level h) Sound power level i) Cutting width</p> <p>Person authorized to complete the Technical Document: ST S.p.A. Via del Lavoro, 6 31033 Castelfranco Veneto (TV) - Italy</p> <p>g) Castelfranco Veneto, 09.09.2019</p> <p>CEO Rigpa Group Sean Robinson</p>	<p>CE (Dichiarazione di Conformità) Dichiarazione di Conformità, Annesso II, parte A</p> <p>1. Die Firma 1.1. Die Firma, die für ihre eigene Verantwortung die Maschine "Tosarba a piedi a conduttore a piedi" mit Benzinmotor</p> <p>1.2. Die Basis-Modell 1.3. Die Basis-Modell der Konstruktion 1.4. Motor 1.5. Motor mit CE-Zulassung 1.6. Technische Spezifikationen 1.7. CE-Zertifizierung 1.8. CE-Typenstandards 1.9. Harmonisierte Standards 1.10. CE-Typenstandards 1.11. Schallleistung 1.12. Schallleistung 1.13. Schnittbreite</p> <p>2. Ich erkläre unter meiner Verantwortung, dass die Technische Dokumentation "Tosarba a piedi a conduttore a piedi" mit Benzinmotor den Anforderungen der folgenden Richtlinien entspricht:</p> <ul style="list-style-type: none"> - MD: 2006/42/EG e) CE-Zertifikat-Etikette: / f) CE-Typenprüfung: / - OND: 2009/142/EG, ANHANG VI - 2005/88/EG g) CE-Typen-Etikette: / h) CE-Zertifikat-Etikette: / - EMC: 2014/53/EU - RoHS II: 2011/65/EU - 2015/863/EU <p>4. Bezugnahme auf die Harmonisierten Standards:</p> <p>EN ISO 5395-1:2013+A1:2019 EN ISO 5395-2:2013+A1:2016+A2:2017 EN ISO 8541:2012</p> <p>g) Schallleistung h) Schallleistung i) Schnittbreite</p> <p>Person, die die Technische Dokumentation ausfüllt: ST S.p.A. Via del Lavoro, 6 31033 Castelfranco Veneto (TV) - Italien</p> <p>g) Castelfranco Veneto, 09.09.2019</p> <p>CEO Rigpa Group Sean Robinson</p>

Guarantee

Congratulations on the purchase of your Mountfield lawnmower. This product has been manufactured to the highest quality standards and is guaranteed for domestic use against faulty parts or manufacture for a period of 2 years from the date of purchase. Please note that if the machine is used commercially the guarantee period is 90 days from the date of purchase. If you experience any problem with your Mountfield lawnmower please call our technical helpline on 0800 121 6585 or 1800 806 149 ROI and our operators will endeavour to solve your problem. In the event your problem cannot be resolved over the phone the operator will refer you to one of our local authorised service centres.

This guarantee is subject to the following terms;

- This guarantee is not transferable. An original proof of purchase will be required in the event of a claim.
- The product must be serviced at the recommended intervals by an authorised service centre. A service schedule should be kept including invoicing and receipts. Please phone 0800 121 6585 or 1800 806 149 ROI to locate your nearest Mountfield service centre or visit www.servicelink.org.uk. Service procedures (for example carb cleaning, draining engine oil, blade sharpening, belt and cable adjustment) and consumable parts that require periodic replacement (for example the spark plug, air filter and oil) are not covered under this guarantee. This also applies to parts subject to fair wear and tear (for example wheels, bearings, starter cord, cables, belts and blade).
- Delivery and collection of the machine is your responsibility and not covered under this guarantee.
- The guarantee does not cover any breakages or damage that are a result of the following; misuse, alteration, improper assembly or adjustment, neglect or accident.
- Expenses and costs incurred from loss of utility will not be compensated.
- The guarantee does not cover machines that are transported outside of the UK & Eire.
- Where a mower is fitted with an engine not manufactured by Mountfield, the engine manufacturer guarantees the engine.

This guarantee is in addition to and does not detract from your contractual rights under statute or common law.

On delivery of your new Mountfield mower, we suggest that you complete the box to the right.

The information for your machine is on the serial number label, which is fixed on the cutter deck at the base of the handles. You will be asked for these details if you have any problems or require spare parts.

Please keep your receipt, proof of purchase will be required in the event of a claim.



Type:	
Art.N	
..... -s/n	

Service Record	
<p><u>1st Service</u></p> <p>Date of service</p> <p>Next service due</p> <p>Dealer's Signature</p> <p>Dealer's Stamp:</p>	<p><u>2nd Service</u></p> <p>Date of service</p> <p>Next service due</p> <p>Dealer's Signature</p> <p>Dealer's Stamp:</p>

STIGA LTD
 Unit 8, Bluewater Estate, Bell Close, Plympton, Plymouth, Devon, PL7 4JH, England.
manufactured by ST. SpA Via del Lavoro, 6 I-31033 Castelfranco Veneto (TV) Italy

Part Number 171506305/1