

INSTRUCTION MANUAL



# Cordless Hammer Driver Drill

DHP448

DHP458

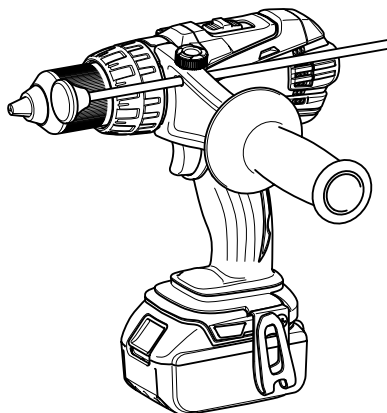

012710

**IMPORTANT:** Read Before Using.

## ENGLISH (Original instructions)

# SPECIFICATIONS

Model		DHP448	DHP458
Capacities	Drilling into concrete	14 mm	16 mm
	Drilling into steel	13 mm	13 mm
	Drilling into wood	65 mm	76 mm
	Fastening wood screw	8 mm x 75 mm	10 mm x 90 mm
	Fastening machine screw	6 mm	
No load speed	High (2)	0 - 1,800 min <sup>-1</sup>	0 - 2,000 min <sup>-1</sup>
	Low (1)	0 - 350 min <sup>-1</sup>	0 - 400 min <sup>-1</sup>
Blows per minute	High (2)	0 - 27,000 min <sup>-1</sup>	0 - 30,000 min <sup>-1</sup>
	Low (1)	0 - 5,200 min <sup>-1</sup>	0 - 6,000 min <sup>-1</sup>
Overall length		225 mm	
Net weight		2.2 kg	2.3 kg
Rated voltage		D.C. 14.4 V	D.C. 18 V

- Due to our continuing program of research and development, the specifications herein are subject to change without notice.
- Specifications and battery cartridge may differ from country to country.
- Weight, with battery cartridge, according to EPTA-Procedure 01/2003

END004-4

## Symbols

The following show the symbols used for the equipment. Be sure that you understand their meaning before use.



• Read instruction manual.



• Only for EU countries

Do not dispose of electric equipment or battery pack together with household waste material!

In observance of European Directive 2002/96/EC on waste electric and electronic equipment, 2006/66/EC on batteries and accumulators and waste batteries and accumulators and their implementation in accordance with national laws, electric equipment and battery pack that have reached the end of their life must be collected separately and returned to an environmentally compatible recycling facility.

ENE079-1

## Intended use

The tool is intended for impact drilling in brick, concrete and stone. It is also suitable for screw driving and drilling without impact in wood, metal, ceramic and plastic.

ENG905-1

## Noise

The typical A-weighted noise level determined according to EN60745:

## Model DHP448

Sound pressure level ( $L_{pA}$ ): 82 dB (A)

Sound power level ( $L_{WA}$ ): 93 dB (A)

Uncertainty (K): 3 dB (A)

## Model DHP458

Sound pressure level ( $L_{pA}$ ): 84 dB (A)

Sound power level ( $L_{WA}$ ): 95 dB (A)

Uncertainty (K): 3 dB (A)

## Wear ear protection

ENG900-1

## Vibration

The vibration total value (tri-axial vector sum) determined according to EN60745:

## Model DHP448

Work mode: impact drilling into concrete

Vibration emission ( $a_{h,1D}$ ): 8.5 m/s<sup>2</sup>

Uncertainty (K): 1.5 m/s<sup>2</sup>

Work mode: drilling into metal

Vibration emission ( $a_{h,1D}$ ): 2.5 m/s<sup>2</sup> or less

Uncertainty (K): 1.5 m/s<sup>2</sup>

## Model DHP458

Work mode: impact drilling into concrete

Vibration emission ( $a_{h,1D}$ ): 9.5 m/s<sup>2</sup>

Uncertainty (K): 1.5 m/s<sup>2</sup>

Work mode: drilling into metal  
 Vibration emission ( $a_{h,D}$ ): 2.5 m/s<sup>2</sup> or less  
 Uncertainty (K): 1.5 m/s<sup>2</sup>

ENG901-1

- The declared vibration emission value has been measured in accordance with the standard test method and may be used for comparing one tool with another.
- The declared vibration emission value may also be used in a preliminary assessment of exposure.

#### **⚠️WARNING:**

- The vibration emission during actual use of the power tool can differ from the declared emission value depending on the ways in which the tool is used.
- Be sure to identify safety measures to protect the operator that are based on an estimation of exposure in the actual conditions of use (taking account of all parts of the operating cycle such as the times when the tool is switched off and when it is running idle in addition to the trigger time).

ENH101-17

#### **For European countries only**

#### **EC Declaration of Conformity**

**Makita declares that the following Machine(s):**

Designation of Machine:

Cordless Hammer Driver Drill

Model No./ Type: DHP448,DHP458

**Conforms to the following European Directives:**

2006/42/EC

They are manufactured in accordance with the following standard or standardized documents:

EN60745

The technical file in accordance with 2006/42/EC is available from:

Makita, Jan-Baptist Vinkstraat 2, 3070, Belgium

31.12.2013



Yasushi Fukaya  
 Director

Makita, Jan-Baptist Vinkstraat 2, 3070, Belgium

000331

## **General Power Tool Safety Warnings**

**⚠️ WARNING** Read all safety warnings and all instructions. Failure to follow the warnings and instructions may result in electric shock, fire and/or serious injury.

### **Save all warnings and instructions for future reference.**

The term "power tool" in the warnings refers to your mains-operated (corded) power tool or battery-operated (cordless) power tool.

#### **Work area safety**

1. **Keep work area clean and well lit.** Cluttered or dark areas invite accidents.
2. **Do not operate power tools in explosive atmospheres, such as in the presence of flammable liquids, gases or dust.** Power tools create sparks which may ignite the dust or fumes.
3. **Keep children and bystanders away while operating a power tool.** Distractions can cause you to lose control.

#### **Electrical safety**

4. **Power tool plugs must match the outlet. Never modify the plug in any way. Do not use any adapter plugs with earthed (grounded) power tools.** Unmodified plugs and matching outlets will reduce risk of electric shock.
5. **Avoid body contact with earthed or grounded surfaces such as pipes, radiators, ranges and refrigerators.** There is an increased risk of electric shock if your body is earthed or grounded.
6. **Do not expose power tools to rain or wet conditions.** Water entering a power tool will increase the risk of electric shock.
7. **Do not abuse the cord. Never use the cord for carrying, pulling or unplugging the power tool. Keep cord away from heat, oil, sharp edges or moving parts.** Damaged or entangled cords increase the risk of electric shock.
8. **When operating a power tool outdoors, use an extension cord suitable for outdoor use.** Use of a cord suitable for outdoor use reduces the risk of electric shock.
9. **If operating a power tool in a damp location is unavoidable, use a ground fault circuit interrupter (GFCI) protected supply.** Use of an GFCI reduces the risk of electric shock.

#### **Personal safety**

10. **Stay alert, watch what you are doing and use common sense when operating a power tool. Do not use a power tool while you are tired or under the influence of drugs, alcohol or**

**medication.** A moment of inattention while operating power tools may result in serious personal injury.

11. **Use personal protective equipment. Always wear eye protection.** Protective equipment such as dust mask, non-skid safety shoes, hard hat, or hearing protection used for appropriate conditions will reduce personal injuries.
12. **Prevent unintentional starting. Ensure the switch is in the off-position before connecting to power source and/or battery pack, picking up or carrying the tool.** Carrying power tools with your finger on the switch or energising power tools that have the switch on invites accidents.
13. **Remove any adjusting key or wrench before turning the power tool on.** A wrench or a key left attached to a rotating part of the power tool may result in personal injury.
14. **Do not overreach. Keep proper footing and balance at all times.** This enables better control of the power tool in unexpected situations.
15. **Dress properly. Do not wear loose clothing or jewellery. Keep your hair, clothing, and gloves away from moving parts.** Loose clothes, jewellery or long hair can be caught in moving parts.
16. **If devices are provided for the connection of dust extraction and collection facilities, ensure these are connected and properly used.** Use of dust collection can reduce dust-related hazards.

#### **Power tool use and care**

17. **Do not force the power tool. Use the correct power tool for your application.** The correct power tool will do the job better and safer at the rate for which it was designed.
18. **Do not use the power tool if the switch does not turn it on and off.** Any power tool that cannot be controlled with the switch is dangerous and must be repaired.
19. **Disconnect the plug from the power source and/or the battery pack from the power tool before making any adjustments, changing accessories, or storing power tools.** Such preventive safety measures reduce the risk of starting the power tool accidentally.
20. **Store idle power tools out of the reach of children and do not allow persons unfamiliar with the power tool or these instructions to operate the power tool.** Power tools are dangerous in the hands of untrained users.
21. **Maintain power tools. Check for misalignment or binding of moving parts, breakage of parts and any other condition that may affect the power tool's operation. If damaged, have the power tool repaired before use.** Many accidents

are caused by poorly maintained power tools.

22. **Keep cutting tools sharp and clean.** Properly maintained cutting tools with sharp cutting edges are less likely to bind and are easier to control.
23. **Use the power tool, accessories and tool bits etc. in accordance with these instructions, taking into account the working conditions and the work to be performed.** Use of the power tool for operations different from those intended could result in a hazardous situation.

#### **Battery tool use and care**

24. **Recharge only with the charger specified by the manufacturer.** A charger that is suitable for one type of battery pack may create a risk of fire when used with another battery pack.
25. **Use power tools only with specifically designated battery packs.** Use of any other battery packs may create a risk of injury and fire.
26. **When battery pack is not in use, keep it away from other metal objects, like paper clips, coins, keys, nails, screws or other small metal objects, that can make a connection from one terminal to another.** Shorting the battery terminals together may cause burns or a fire.
27. **Under abusive conditions, liquid may be ejected from the battery; avoid contact. If contact accidentally occurs, flush with water. If liquid contacts eyes, additionally seek medical help.** Liquid ejected from the battery may cause irritation or burns.

#### **Service**

28. **Have your power tool serviced by a qualified repair person using only identical replacement parts.** This will ensure that the safety of the power tool is maintained.
29. **Follow instruction for lubricating and changing accessories.**
30. **Keep handles dry, clean and free from oil and grease.**

GEB056-4

## **CORDLESS HAMMER DRIVER DRILL SAFETY WARNINGS**

1. **Wear ear protectors with impact drilling.** Exposure to noise can cause hearing loss.
2. **Use auxiliary handle(s), if supplied with the tool.** Loss of control can cause personal injury.
3. **Hold power tool by insulated gripping surfaces, when performing an operation where the cutting accessory may contact hidden wiring.** Cutting accessory contacting a "live" wire may make exposed metal parts of the power tool "live" and could give the operator an electric shock.

4. **Hold power tool by insulated gripping surfaces, when performing an operation where the fastener may contact hidden wiring.** Fasteners contacting a "live" wire may make exposed metal parts of the power tool "live" and could give the operator an electric shock.
5. **Always be sure you have a firm footing.** Be sure no one is below when using the tool in high locations.
6. **Hold the tool firmly.**
7. **Keep hands away from rotating parts.**
8. **Do not leave the tool running. Operate the tool only when hand-held.**
9. **Do not touch the bit or the workpiece immediately after operation; they may be extremely hot and could burn your skin.**
10. **Some material contains chemicals which may be toxic. Take caution to prevent dust inhalation and skin contact. Follow material supplier safety data.**

## SAVE THESE INSTRUCTIONS.

### **⚠WARNING:**

DO NOT let comfort or familiarity with product (gained from repeated use) replace strict adherence to safety rules for the subject product. MISUSE or failure to follow the safety rules stated in this instruction manual may cause serious personal injury.

ENC007-7

## IMPORTANT SAFETY INSTRUCTIONS

### FOR BATTERY CARTRIDGE

1. Before using battery cartridge, read all instructions and cautionary markings on (1) battery charger, (2) battery, and (3) product using battery.
2. Do not disassemble battery cartridge.
3. If operating time has become excessively shorter, stop operating immediately. It may result in a risk of overheating, possible burns and even an explosion.
4. If electrolyte gets into your eyes, rinse them out with clear water and seek medical attention right away. It may result in loss of your eyesight.
5. Do not short the battery cartridge:
  - (1) Do not touch the terminals with any conductive material.
  - (2) Avoid storing battery cartridge in a container with other metal objects such as nails, coins, etc.
- (3) Do not expose battery cartridge to water or rain.
 

A battery short can cause a large current flow, overheating, possible burns and even a breakdown.
6. Do not store the tool and battery cartridge in locations where the temperature may reach or exceed 50 ° C (122 ° F).
7. Do not incinerate the battery cartridge even if it is severely damaged or is completely worn out. The battery cartridge can explode in a fire.
8. Be careful not to drop or strike battery.
9. Do not use a damaged battery.

## SAVE THESE INSTRUCTIONS.

### Tips for maintaining maximum battery life

1. Charge the battery cartridge before completely discharged. Always stop tool operation and charge the battery cartridge when you notice less tool power.
2. Never recharge a fully charged battery cartridge. Overcharging shortens the battery service life.
3. Charge the battery cartridge with room temperature at 10 ° C - 40 ° C (50 ° F - 104 ° F). Let a hot battery cartridge cool down before charging it.
4. Charge the battery cartridge once in every six months if you do not use it for a long period of time.

## FUNCTIONAL DESCRIPTION

### ⚠CAUTION:

- Always be sure that the tool is switched off and the battery cartridge is removed before adjusting or checking function on the tool.

### Installing or removing battery cartridge

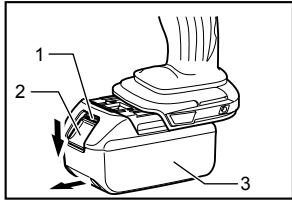

012695

1. Red indicator
2. Button
3. Battery cartridge

### ⚠CAUTION:

- Always switch off the tool before installing or removing the battery cartridge.

To remove the battery cartridge, slide it from the tool while sliding the button on the front of the cartridge.

To install the battery cartridge, align the tongue on the battery cartridge with the groove in the housing and slip it into place. Insert it all the way until it locks in place with a little click. If you can see the red indicator on the upper side of the button, it is not locked completely.

### ⚠CAUTION:

- Always install the battery cartridge fully until the red indicator cannot be seen. If not, it may accidentally fall out of the tool, causing injury to you or someone around you.
- Do not use force when installing the battery cartridge. If the cartridge does not slide in easily, it is not being inserted correctly.

### Battery protection system (Lithium-ion battery with star marking)

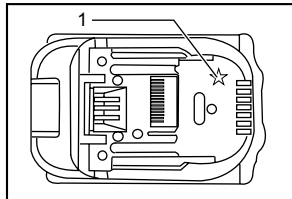

012128

1. Star marking

Lithium-ion batteries with a star marking are equipped with a protection system. This system automatically cuts off power to the tool to extend battery life.

The tool will automatically stop during operation if the tool and/or battery are placed under one of the following conditions:

- **Overloaded:**  
The tool is operated in a manner that causes it to draw an abnormally high current. In this situation, release the switch trigger on the tool and stop the application that caused the tool to become overloaded. Then pull the switch trigger again to restart. If the tool does not start, the battery is overheated. In this situation, let the battery cool before pulling the switch trigger again.
- **Low battery voltage:**  
The remaining battery capacity is too low and the tool will not operate. In this situation, remove and recharge the battery.

### Switch action

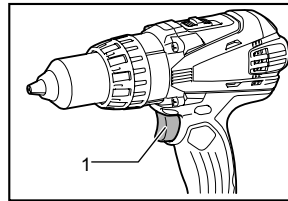

012699

1. Switch trigger

### ⚠CAUTION:

- Before inserting the battery cartridge into the tool, always check to see that the switch trigger actuates properly and returns to the "OFF" position when released.

To start the tool, simply pull the switch trigger. Tool speed is increased by increasing pressure on the switch trigger. Release the switch trigger to stop.

### Lighting up the front lamp

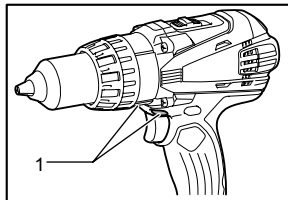

012700

1. Lamp

### ⚠CAUTION:

- Do not look in the light or see the source of light directly.

Pull the switch trigger to light up the lamp. The lamp keeps on lighting while the switch trigger is being pulled. The lamp goes out 10 -15 seconds after releasing the trigger.

**NOTE:**

- Use a dry cloth to wipe the dirt off the lens of lamp. Be careful not to scratch the lens of lamp, or it may lower the illumination.

**Reversing switch action**

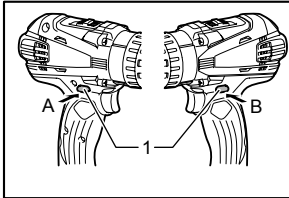

1. Reversing switch lever

012701

This tool has a reversing switch to change the direction of rotation. Depress the reversing switch lever from the A side for clockwise rotation or from the B side for counterclockwise rotation.

When the reversing switch lever is in the neutral position, the switch trigger cannot be pulled.

**CAUTION:**

- Always check the direction of rotation before operation.
- Use the reversing switch only after the tool comes to a complete stop. Changing the direction of rotation before the tool stops may damage the tool.
- When not operating the tool, always set the reversing switch lever to the neutral position.

**Speed change**

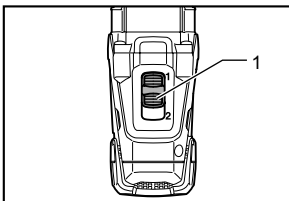

1. Speed change lever

012702

To change the speed, first switch off the tool and then slide the speed change lever to the "2" side for high speed or, "1" side for low speed. Be sure that the speed change lever is set to the correct position before operation. Use the right speed for your job.

**CAUTION:**

- Always set the speed change lever fully to the correct position. If you operate the tool with the speed change lever positioned halfway between the "1" side and "2" side, the tool may be damaged.
- Do not use the speed change lever while the tool is running. The tool may be damaged.

**Selecting the action mode**

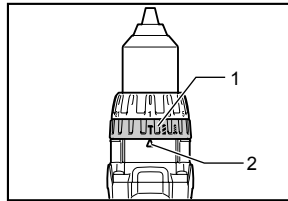

1. Action mode changing ring  
2. Arrow

012736

This tool employs an action mode changing ring. Select one of the three modes suitable for your work needs by using this ring.

For rotation only, turn the ring so that the arrow on the tool body points toward the ⚙ mark on the ring.

For rotation with hammering, turn the ring so that the arrow points toward the ⚡ mark on the ring.

For rotation with clutch, turn the ring so that the arrow points toward the ⚙ mark on the ring.

**CAUTION:**

- Always set the ring correctly to your desired mode mark. If you operate the tool with the ring positioned halfway between the mode marks, the tool may be damaged.

**Adjusting the fastening torque (screwdriver mode "⚙")**

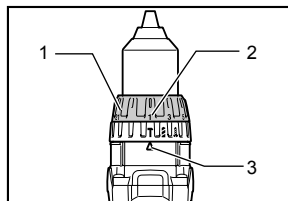

1. Adjusting ring  
2. Graduation  
3. Arrow

012735

The fastening torque can be adjusted in 21 steps by turning the adjusting ring so that its graduations are aligned with the pointer on the tool body.

First, slide the action mode change lever to the position of ⚙ symbol.

The fastening torque is minimum when the number 1 is aligned with the pointer, and maximum when the marking is aligned with the pointer. The clutch will slip at various torque levels when set at the number 1 to 21. Before actual operation, drive a trial screw into your material or a piece of duplicate material to determine which torque level is required for a particular application.

**NOTE:**

- The adjusting ring does not lock when the pointer is positioned only halfway between the graduations.

## Empty signal for remaining battery capacity

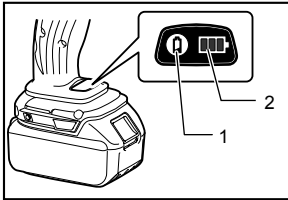

1. Button
2. LED indicator

012714

Stop the tool and with the tool stopped press the button on the switch panel and the remaining battery capacity will be signaled on the panel.

The status displayed on the switch panel and the remaining battery capacity is shown in the following table.

LED indicator status	Remaining battery capacity
	About 50% or more
	About 20% - 50%
	About less than 20%

012023

### NOTE:

- Before checking the remaining battery capacity, be sure to stop the tool.

## ASSEMBLY

### ⚠CAUTION:

- Always be sure that the tool is switched off and the battery cartridge is removed before carrying out any work on the tool.

### Installing side grip (auxiliary handle)

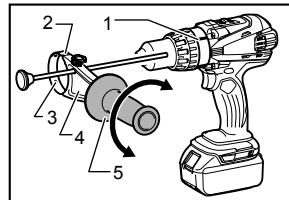

1. Groove
2. Protrusion
3. Steel band
4. Grip base
5. Side grip

012711

Always use the side grip to ensure operating safety. Insert the side grip so that the protrusions on the grip base and steel band fit in between the grooves on the tool barrel. Then tighten the grip by turning clockwise. When you turn the side grip, loosen and remove the grip, then turn the grip and insert it again.

### Installing or removing driver bit or drill bit

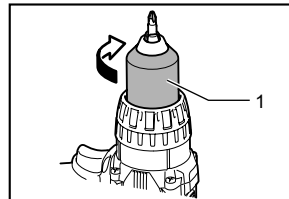

1. Sleeve

012697

Turn the sleeve counterclockwise to open the chuck jaws. Place the bit in the chuck as far as it will go. Turn the sleeve clockwise to tighten the chuck. To remove the bit, turn the sleeve counterclockwise.

### Installing bit holder

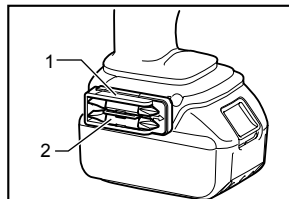

1. Bit holder
2. Bit

012708

Fit the bit holder into the protrusion at the tool foot on either right or left side and secure it with a screw. When not using the driver bit, keep it in the bit holders. Bits 45 mm long can be kept there.



## Adjustable depth rod

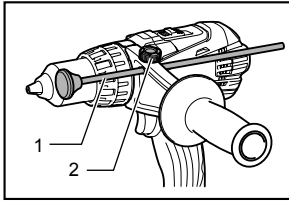

1. Depth rod
2. Clamp screw

012712

The adjustable depth rod is used to drill holes of uniform depth. Loosen the clamp screw, set to desired position, then tighten the clamp screw.

## Hook

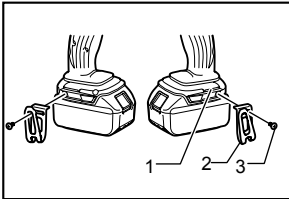

1. Groove
2. Hook
3. Screw

012698

The hook is convenient for temporarily hanging the tool. This can be installed on either side of the tool.

To install the hook, insert it into a groove in the tool housing on either side and then secure it with a screw. To remove, loosen the screw and then take it out.

## OPERATION

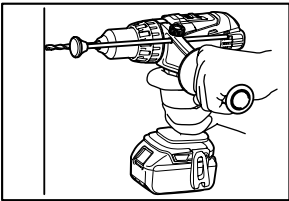

012737

## Hammer drilling operation

### ⚠CAUTION:

- There is a tremendous and sudden twisting force exerted on the tool/bit at the time of hole break-through, when the hole becomes clogged with chips and particles, or when striking reinforcing rods embedded in the concrete. Always use the side grip (auxiliary handle) and firmly hold the tool by both side grip and switch handle during operations. Failure to do so may result in the loss of control of the tool and potentially severe injury.

First, slide the action mode change lever so that it points to the  $\nabla$  marking. The adjusting ring can be aligned in any torque levels for this operation.

Be sure to use a tungsten-carbide tipped bit.

Position the bit at the desired location for the hole, then pull the switch trigger. Do not force the tool. Light pressure gives best results. Keep the tool in position and prevent it from slipping away from the hole.

Do not apply more pressure when the hole becomes clogged with chips or particles. Instead, run the tool at an idle, then remove the bit partially from the hole. By repeating this several times, the hole will be cleaned out and normal drilling may be resumed.

## Blow-out bulb (optional accessory)

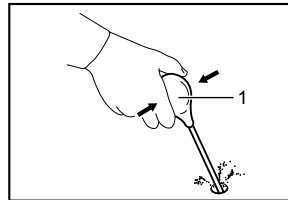

1. Blow-out bulb

002449

After drilling the hole, use the blow-out bulb to clean the dust out of the hole.

## Screwdriving operation

First, slide the action mode change lever so that it points to the  $\blacktriangle$  marking. Adjust the adjusting ring to the proper torque level for your work. Then proceed as follows.

Place the point of the driver bit in the screw head and apply pressure to the tool. Start the tool slowly and then increase the speed gradually. Release the switch trigger as soon as the clutch cuts in.

### NOTE:

- Make sure that the driver bit is inserted straight in the screw head, or the screw and/or bit may be damaged.
- When driving wood screw, predrill a pilot hole 2/3 the diameter of the screw. It makes driving easier and prevents splitting of the workpiece.
- If the tool is operated continuously until the battery cartridge has discharged, allow the tool to rest for 15 minutes before proceeding with a fresh battery.

## Drilling operation

### ⚠CAUTION:

- Pressing excessively on the tool will not speed up the drilling. In fact, this excessive pressure will only serve to damage the tip of your bit, decrease the tool performance and shorten the service life of the tool.

- There is a tremendous force exerted on the tool/bit at the time of hole break through. Hold the tool firmly and exert care when the bit begins to break through the workpiece.
- A stuck bit can be removed simply by setting the reversing switch to reverse rotation in order to back out. However, the tool may back out abruptly if you do not hold it firmly.
- Always secure small workpieces in a vise or similar hold-down device.
- If the tool is operated continuously until the battery cartridge has discharged, allow the tool to rest for 15 minutes before proceeding with a fresh battery.

First, slide the action mode change lever so that it points to the  marking. The adjusting ring can be aligned in any torque levels for this operation. Then proceed as follows.

### Drilling in wood

When drilling in wood, the best results are obtained with wood drills equipped with a guide screw. The guide screw makes drilling easier by pulling the bit into the workpiece.

### Drilling in metal

To prevent the bit from slipping when starting a hole, make an indentation with a center-punch and hammer at the point to be drilled. Place the point of the bit in the indentation and start drilling.

Use a cutting lubricant when drilling metals. The exceptions are iron and brass which should be drilled dry.

## MAINTENANCE

### ⚠ CAUTION:

- Always be sure that the tool is switched off and the battery cartridge is removed before attempting to perform inspection or maintenance.
- Never use gasoline, benzene, thinner, alcohol or the like. Discoloration, deformation or cracks may result.

### Replacing carbon brushes

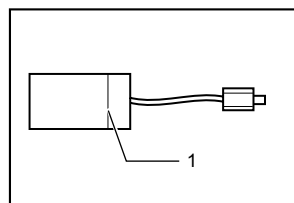

1. Limit mark

006258

Replace when they wear down to the limit mark. Keep the carbon brushes clean and free to slip in the holders. Both carbon brushes should be replaced at the same time. Use only identical carbon brushes.

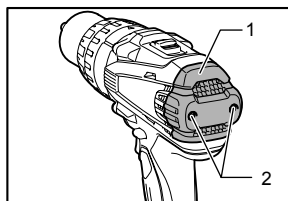

1. Rear cover  
2. Screws

012705

Use a screwdriver to remove two screws then remove the rear cover.

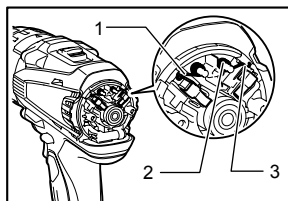

1. Arm  
2. Spring  
3. Recessed part

012706

Raise the arm part of the spring and then place it in the recessed part of the housing with a slotted bit screwdriver of slender shaft or the like.

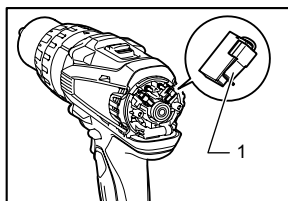

1. Carbon brush cap

012707

Use pliers to remove the carbon brush caps of the carbon brushes. Take out the worn carbon brushes, insert the new ones and replace the carbon brush caps in reverse.

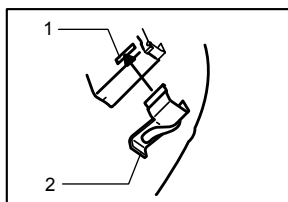

1. Hole  
2. Carbon brush cap

006304

Make sure that the carbon brush caps have fit into the holes in brush holders securely.

Reinstall the rear cover and tighten two screws securely. To maintain product SAFETY and RELIABILITY, repairs, any other maintenance or adjustment should be performed by Makita Authorized Service Centers, always using Makita replacement parts.

---

## OPTIONAL ACCESSORIES

### CAUTION:

- These accessories or attachments are recommended for use with your Makita tool specified in this manual. The use of any other accessories or attachments might present a risk of injury to persons. Only use accessory or attachment for its stated purpose.

If you need any assistance for more details regarding these accessories, ask your local Makita Service Center.

- Drill bits
- Hammer drill bits
- Screw bits
- Blow-out bulb
- Safety goggles
- Makita genuine battery and charger
- Grip assembly
- Depth rod
- Hook
- Rubber pad assembly
- Wool bonnet
- Foam polishing pad
- Battery protector

### NOTE:

- Some items in the list may be included in the tool package as standard accessories. They may differ from country to country.

**Makita** Jan-Baptist Vinkstraat 2, 3070, Belgium  
**Makita Corporation** Anjo, Aichi, Japan

INSTRUCTION MANUAL



# Cordless Impact Driver

## DTD156

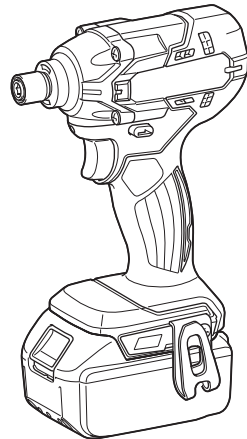

Read before use.

# SPECIFICATIONS

<b>Model:</b>		<b>DTD156</b>
Fastening capacities	Machine screw	M4 - M8
	Standard bolt	M5 - M14
	High tensile bolt	M5 - M12
No load speed		0 - 2,500 min <sup>-1</sup>
Impacts per minute		0 - 3,000 min <sup>-1</sup>
Overall length		143 mm
Rated voltage		D.C. 18 V
Net weight		1.3-1.6 kg

- Due to our continuing program of research and development, the specifications herein are subject to change without notice.
- Specifications may differ from country to country.
- The weight may differ depending on the attachment(s), including the battery cartridge. The lightest and heaviest combination, according to EPTA-Procedure 01/2014, are shown in the table.

## Applicable battery cartridge and charger

Battery cartridge	BL1815N / BL1820 / BL1820B / BL1830 / BL1830B / BL1840 / BL1840B / BL1850 / BL1850B / BL1860B
Charger	DC18RC / DC18RD / DC18RE / DC18SD / DC18SE / DC18SF / DC18SH

- Some of the battery cartridges and chargers listed above may not be available depending on your region of residence.

**⚠ WARNING:** Only use the battery cartridges and chargers listed above. Use of any other battery cartridges and chargers may cause injury and/or fire.

## Symbols

The followings show the symbols used for the equipment. Be sure that you understand their meaning before use.



Read instruction manual.



Only for EU countries  
Do not dispose of electric equipment or battery pack together with household waste material! In observance of the European Directives, on Waste Electric and Electronic Equipment and Batteries and Accumulators and Waste Batteries and Accumulators and their implementation in accordance with national laws, electric equipment and batteries and battery pack(s) that have reached the end of their life must be collected separately and returned to an environmentally compatible recycling facility.

## Intended use

The tool is intended for screw driving in wood, metal and plastic.

## Noise

The typical A-weighted noise level determined according to EN62841-2-2:

Sound pressure level ( $L_{pA}$ ): 92 dB(A)

Sound power level ( $L_{WA}$ ): 103 dB(A)

Uncertainty (K): 3 dB(A)

**NOTE:** The declared noise emission value(s) has been measured in accordance with a standard test method and may be used for comparing one tool with another.

**NOTE:** The declared noise emission value(s) may also be used in a preliminary assessment of exposure.

**⚠ WARNING:** Wear ear protection.

**⚠ WARNING:** The noise emission during actual use of the power tool can differ from the declared value(s) depending on the ways in which the tool is used especially what kind of workpiece is processed.

**⚠ WARNING:** Be sure to identify safety measures to protect the operator that are based on an estimation of exposure in the actual conditions of use (taking account of all parts of the operating cycle such as the times when the tool is switched off and when it is running idle in addition to the trigger time).

## Vibration

The vibration total value (tri-axial vector sum) determined according to EN62841-2-2:

Work mode: impact tightening of fasteners of the maximum capacity of the tool

Vibration emission ( $a_{hv}$ ): 10,0 m/s<sup>2</sup>

Uncertainty (K): 1.5 m/s<sup>2</sup>

**NOTE:** The declared vibration total value(s) has been measured in accordance with a standard test method and may be used for comparing one tool with another.

**NOTE:** The declared vibration total value(s) may also be used in a preliminary assessment of exposure.

**⚠WARNING:** The vibration emission during actual use of the power tool can differ from the declared value(s) depending on the ways in which the tool is used especially what kind of workpiece is processed.

**⚠WARNING:** Be sure to identify safety measures to protect the operator that are based on an estimation of exposure in the actual conditions of use (taking account of all parts of the operating cycle such as the times when the tool is switched off and when it is running idle in addition to the trigger time).

## EC Declaration of Conformity

### For European countries only

The EC declaration of conformity is included as Annex A to this instruction manual.

# SAFETY WARNINGS

## General power tool safety warnings

**⚠WARNING:** Read all safety warnings, instructions, illustrations and specifications provided with this power tool. Failure to follow all instructions listed below may result in electric shock, fire and/or serious injury.

## Save all warnings and instructions for future reference.

The term "power tool" in the warnings refers to your mains-operated (corded) power tool or battery-operated (cordless) power tool.

### Work area safety

1. **Keep work area clean and well lit.** Cluttered or dark areas invite accidents.
2. **Do not operate power tools in explosive atmospheres, such as in the presence of flammable liquids, gases or dust.** Power tools create sparks which may ignite the dust or fumes.
3. **Keep children and bystanders away while operating a power tool.** Distractions can cause you to lose control.

### Electrical safety

1. **Power tool plugs must match the outlet. Never modify the plug in any way. Do not use any adapter plugs with earthed (grounded) power tools.** Unmodified plugs and matching outlets will reduce risk of electric shock.

2. **Avoid body contact with earthed or grounded surfaces, such as pipes, radiators, ranges and refrigerators.** There is an increased risk of electric shock if your body is earthed or grounded.
3. **Do not expose power tools to rain or wet conditions.** Water entering a power tool will increase the risk of electric shock.
4. **Do not abuse the cord. Never use the cord for carrying, pulling or unplugging the power tool. Keep cord away from heat, oil, sharp edges or moving parts.** Damaged or entangled cords increase the risk of electric shock.
5. **When operating a power tool outdoors, use an extension cord suitable for outdoor use.** Use of a cord suitable for outdoor use reduces the risk of electric shock.
6. **If operating a power tool in a damp location is unavoidable, use a residual current device (RCD) protected supply.** Use of an RCD reduces the risk of electric shock.
7. **Power tools can produce electromagnetic fields (EMF) that are not harmful to the user.** However, users of pacemakers and other similar medical devices should contact the maker of their device and/or doctor for advice before operating this power tool.

### Personal safety

1. **Stay alert, watch what you are doing and use common sense when operating a power tool. Do not use a power tool while you are tired or under the influence of drugs, alcohol or medication.** A moment of inattention while operating power tools may result in serious personal injury.
2. **Use personal protective equipment. Always wear eye protection.** Protective equipment such as a dust mask, non-skid safety shoes, hard hat or hearing protection used for appropriate conditions will reduce personal injuries.
3. **Prevent unintentional starting. Ensure the switch is in the off-position before connecting to power source and/or battery pack, picking up or carrying the tool.** Carrying power tools with your finger on the switch or energising power tools that have the switch on invites accidents.
4. **Remove any adjusting key or wrench before turning the power tool on.** A wrench or a key left attached to a rotating part of the power tool may result in personal injury.
5. **Do not overreach. Keep proper footing and balance at all times.** This enables better control of the power tool in unexpected situations.
6. **Dress properly. Do not wear loose clothing or jewellery. Keep your hair and clothing away from moving parts.** Loose clothes, jewellery or long hair can be caught in moving parts.
7. **If devices are provided for the connection of dust extraction and collection facilities, ensure these are connected and properly used.** Use of dust collection can reduce dust-related hazards.
8. **Do not let familiarity gained from frequent use of tools allow you to become complacent and ignore tool safety principles.** A careless action can cause severe injury within a fraction of a second.

9. **Always wear protective goggles to protect your eyes from injury when using power tools. The goggles must comply with ANSI Z87.1 in the USA, EN 166 in Europe, or AS/NZS 1336 in Australia/New Zealand. In Australia/New Zealand, it is legally required to wear a face shield to protect your face, too.**

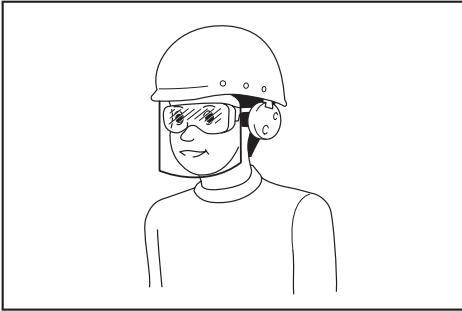

**It is an employer's responsibility to enforce the use of appropriate safety protective equipments by the tool operators and by other persons in the immediate working area.**

#### **Power tool use and care**

1. **Do not force the power tool. Use the correct power tool for your application.** The correct power tool will do the job better and safer at the rate for which it was designed.
2. **Do not use the power tool if the switch does not turn it on and off.** Any power tool that cannot be controlled with the switch is dangerous and must be repaired.
3. **Disconnect the plug from the power source and/or remove the battery pack, if detachable, from the power tool before making any adjustments, changing accessories, or storing power tools.** Such preventive safety measures reduce the risk of starting the power tool accidentally.
4. **Store idle power tools out of the reach of children and do not allow persons unfamiliar with the power tool or these instructions to operate the power tool.** Power tools are dangerous in the hands of untrained users.
5. **Maintain power tools and accessories. Check for misalignment or binding of moving parts, breakage of parts and any other condition that may affect the power tool's operation. If damaged, have the power tool repaired before use.** Many accidents are caused by poorly maintained power tools.
6. **Keep cutting tools sharp and clean.** Properly maintained cutting tools with sharp cutting edges are less likely to bind and are easier to control.
7. **Use the power tool, accessories and tool bits etc. in accordance with these instructions, taking into account the working conditions and the work to be performed.** Use of the power tool for operations different from those intended could result in a hazardous situation.
8. **Keep handles and grasping surfaces dry, clean and free from oil and grease.** Slippery handles and grasping surfaces do not allow for safe handling and control of the tool in unexpected situations.

9. **When using the tool, do not wear cloth work gloves which may be entangled.** The entanglement of cloth work gloves in the moving parts may result in personal injury.

#### **Battery tool use and care**

1. **Recharge only with the charger specified by the manufacturer.** A charger that is suitable for one type of battery pack may create a risk of fire when used with another battery pack.
2. **Use power tools only with specifically designed battery packs.** Use of any other battery packs may create a risk of injury and fire.
3. **When battery pack is not in use, keep it away from other metal objects, like paper clips, coins, keys, nails, screws or other small metal objects, that can make a connection from one terminal to another.** Shorting the battery terminals together may cause burns or a fire.
4. **Under abusive conditions, liquid may be ejected from the battery; avoid contact. If contact accidentally occurs, flush with water. If liquid contacts eyes, additionally seek medical help.** Liquid ejected from the battery may cause irritation or burns.
5. **Do not use a battery pack or tool that is damaged or modified.** Damaged or modified batteries may exhibit unpredictable behaviour resulting in fire, explosion or risk of injury.
6. **Do not expose a battery pack or tool to fire or excessive temperature.** Exposure to fire or temperature above 130 °C may cause explosion.
7. **Follow all charging instructions and do not charge the battery pack or tool outside the temperature range specified in the instructions.** Charging improperly or at temperatures outside the specified range may damage the battery and increase the risk of fire.

#### **Service**

1. **Have your power tool serviced by a qualified repair person using only identical replacement parts.** This will ensure that the safety of the power tool is maintained.
2. **Never service damaged battery packs.** Service of battery packs should only be performed by the manufacturer or authorized service providers.
3. **Follow instruction for lubricating and changing accessories.**

### **Cordless impact driver safety warnings**

1. **Hold the power tool by insulated gripping surfaces, when performing an operation where the fastener may contact hidden wiring.** Fasteners contacting a "live" wire may make exposed metal parts of the power tool "live" and could give the operator an electric shock.
2. **Always be sure you have a firm footing. Be sure no one is below when using the tool in high locations.**
3. **Hold the tool firmly.**
4. **Wear ear protectors.**



5. Do not touch the bit or the workpiece immediately after operation. They may be extremely hot and could burn your skin.
6. Keep hands away from rotating parts.
7. Use auxiliary handle(s), if supplied with the tool. Loss of control can cause personal injury.
8. Hold the power tool by insulated gripping surfaces, when performing an operation where the cutting accessory may contact hidden wiring. Cutting accessory contacting a "live" wire may make exposed metal parts of the power tool "live" and could give the operator an electric shock.
10. The contained lithium-ion batteries are subject to the Dangerous Goods Legislation requirements.  
For commercial transports e.g. by third parties, forwarding agents, special requirement on packaging and labeling must be observed. For preparation of the item being shipped, consulting an expert for hazardous material is required. Please also observe possibly more detailed national regulations.  
Tape or mask off open contacts and pack up the battery in such a manner that it cannot move around in the packaging.

## SAVE THESE INSTRUCTIONS.

**⚠WARNING:** DO NOT let comfort or familiarity with product (gained from repeated use) replace strict adherence to safety rules for the subject product.

MISUSE or failure to follow the safety rules stated in this instruction manual may cause serious personal injury.

### Important safety instructions for battery cartridge

1. Before using battery cartridge, read all instructions and cautionary markings on (1) battery charger, (2) battery, and (3) product using battery.
2. Do not disassemble battery cartridge.
3. If operating time has become excessively shorter, stop operating immediately. It may result in a risk of overheating, possible burns and even an explosion.
4. If electrolyte gets into your eyes, rinse them out with clear water and seek medical attention right away. It may result in loss of your eyesight.
5. Do not short the battery cartridge:
  - (1) Do not touch the terminals with any conductive material.
  - (2) Avoid storing battery cartridge in a container with other metal objects such as nails, coins, etc.
  - (3) Do not expose battery cartridge to water or rain.

A battery short can cause a large current flow, overheating, possible burns and even a breakdown.

6. Do not store the tool and battery cartridge in locations where the temperature may reach or exceed 50 °C (122 °F).
7. Do not incinerate the battery cartridge even if it is severely damaged or is completely worn out. The battery cartridge can explode in a fire.
8. Be careful not to drop or strike battery.
9. Do not use a damaged battery.

11. When disposing the battery cartridge, remove it from the tool and dispose of it in a safe place. Follow your local regulations relating to disposal of battery.
12. Use the batteries only with the products specified by Makita. Installing the batteries to non-compliant products may result in a fire, excessive heat, explosion, or leak of electrolyte.
13. If the tool is not used for a long period of time, the battery must be removed from the tool.

## SAVE THESE INSTRUCTIONS.

**⚠CAUTION:** Only use genuine Makita batteries. Use of non-genuine Makita batteries, or batteries that have been altered, may result in the battery bursting causing fires, personal injury and damage. It will also void the Makita warranty for the Makita tool and charger.

### Tips for maintaining maximum battery life

1. Charge the battery cartridge before completely discharged. Always stop tool operation and charge the battery cartridge when you notice less tool power.
2. Never recharge a fully charged battery cartridge. Overcharging shortens the battery service life.
3. Charge the battery cartridge with room temperature at 10 °C - 40 °C (50 °F - 104 °F). Let a hot battery cartridge cool down before charging it.
4. Charge the battery cartridge if you do not use it for a long period (more than six months).

# FUNCTIONAL DESCRIPTION

**CAUTION:** Always be sure that the tool is switched off and the battery cartridge is removed before adjusting or checking function on the tool.

## Installing or removing battery cartridge

**CAUTION:** Always switch off the tool before installing or removing of the battery cartridge.

**CAUTION:** Hold the tool and the battery cartridge firmly when installing or removing battery cartridge. Failure to hold the tool and the battery cartridge firmly may cause them to slip off your hands and result in damage to the tool and battery cartridge and a personal injury.

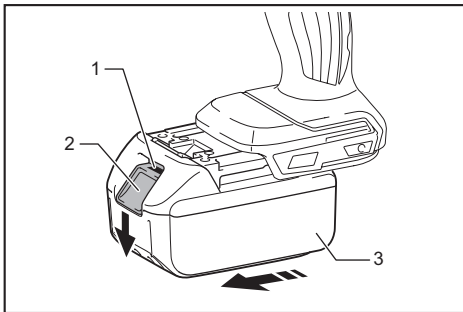

► 1. Red indicator 2. Button 3. Battery cartridge

To remove the battery cartridge, slide it from the tool while sliding the button on the front of the cartridge.

To install the battery cartridge, align the tongue on the battery cartridge with the groove in the housing and slip it into place. Insert it all the way until it locks in place with a little click. If you can see the red indicator on the upper side of the button, it is not locked completely.

**CAUTION:** Always install the battery cartridge fully until the red indicator cannot be seen. If not, it may accidentally fall out of the tool, causing injury to you or someone around you.

**CAUTION:** Do not install the battery cartridge forcibly. If the cartridge does not slide in easily, it is not being inserted correctly.

## Battery protection system

The tool is equipped with a battery protection system. This system automatically cuts off power to the motor to extend battery life.

The tool will automatically stop during operation if the tool and/or battery are placed under one of the following conditions:

### Overloaded:

The tool is operated in a manner that causes it to draw an abnormally high current. In this situation, turn the tool off and stop the application that caused the tool to become overloaded. Then turn the tool on to restart.

If the tool does not start, the battery is overheated. In this situation, let the battery cool before turning the tool on again.

### Low battery voltage:

The remaining battery capacity is too low and the tool will not operate. In this situation, remove and recharge the battery.

## Indicating the remaining battery capacity

Only for battery cartridges with the indicator

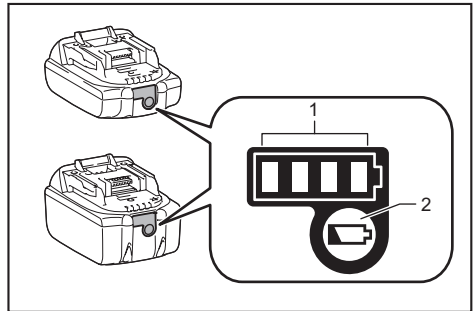

► 1. Indicator lamps 2. Check button

Press the check button on the battery cartridge to indicate the remaining battery capacity. The indicator lamps light up for a few seconds.

Indicator lamps			Remaining capacity
Lighted	Off	Blinking	
■ ■ ■ ■			75% to 100%
■ ■ ■ □			50% to 75%
■ ■ □ □			25% to 50%
■ □ □ □			0% to 25%
▣ □ □ □			Charge the battery.
■ ■ □ □			The battery may have malfunctioned.
□ □ ■ ■			

**NOTE:** Depending on the conditions of use and the ambient temperature, the indication may differ slightly from the actual capacity.

## Switch action

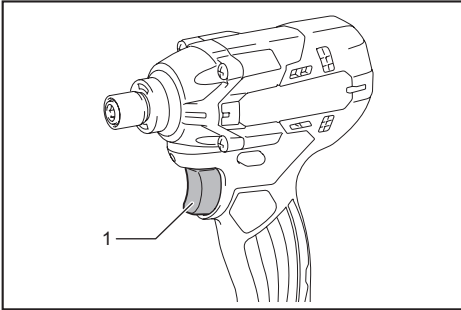

► 1. Switch trigger

**CAUTION:** Before installing the battery cartridge into the tool, always check to see that the switch trigger actuates properly and returns to the "OFF" position when released.

To start the tool, simply pull the switch trigger. Tool speed is increased by increasing pressure on the switch trigger. Release the switch trigger to stop.

## Lighting up the front lamp

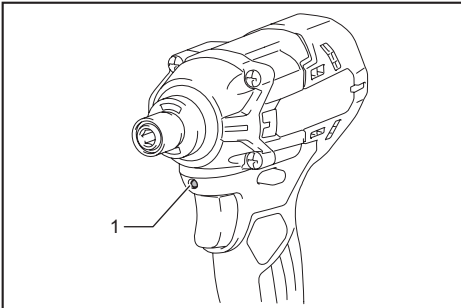

► 1. Lamp

**CAUTION:** Do not look in the light or see the source of light directly.

Pull the switch trigger to light up the lamp. The lamp keeps on lighting while the switch trigger is being pulled. The lamp goes out approximately 10 seconds after releasing the switch trigger.

**NOTE:** Use a dry cloth to wipe the dirt off the lens of the lamp. Be careful not to scratch the lens of lamp, or it may lower the illumination.

## Reversing switch action

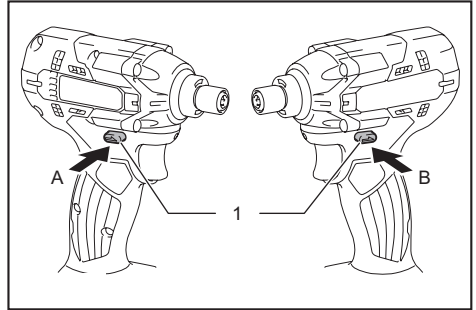

► 1. Reversing switch lever

**CAUTION:** Always check the direction of rotation before operation.

**CAUTION:** Use the reversing switch only after the tool comes to a complete stop. Changing the direction of rotation before the tool stops may damage the tool.

**CAUTION:** When not operating the tool, always set the reversing switch lever to the neutral position.

This tool has a reversing switch to change the direction of rotation. Depress the reversing switch lever from the A side for clockwise rotation or from the B side for counterclockwise rotation.

When the reversing switch lever is in the neutral position, the switch trigger cannot be pulled.

## ASSEMBLY

**CAUTION:** Always be sure that the tool is switched off and the battery cartridge is removed before carrying out any work on the tool.

## Installing or removing driver bit/ socket bit

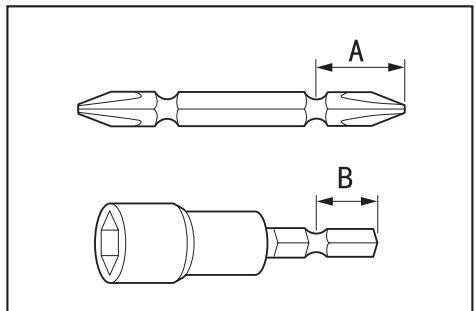

Use only driver bit/socket bit that has inserting portion shown in the figure. Do not use any other driver bit/socket bit.

### For tool with shallow driver bit hole

A=12mm B=9mm	Use only these type of driver bit. Follow the procedure 1. (Note) Bit-piece is not necessary.
-----------------	---

### For tool with deep driver bit hole

A=17mm B=14mm	To install these types of driver bits, follow the procedure 1.
A=12mm B=9mm	To install these types of driver bits, follow the procedure 2. (Note) Bit-piece is necessary for installing the bit.

## Procedure 1

### For tool without one-touch type sleeve

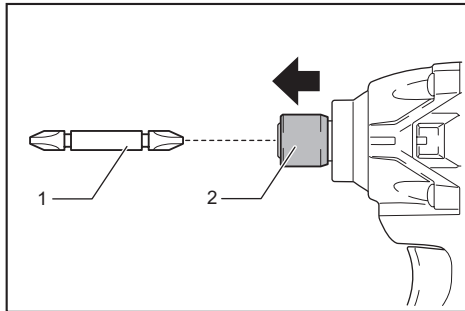

► 1. Driver bit 2. Sleeve

To install the driver bit, pull the sleeve in the direction of the arrow and insert the driver bit into the sleeve as far as it will go. Then release the sleeve to secure the driver bit.

### For tool with one-touch type sleeve

To install the driver bit, insert the driver bit into the sleeve as far as it will go.

## Procedure 2

### Optional accessory

In addition to **Procedure 1**, insert the bit-piece into the sleeve with its pointed end facing in.

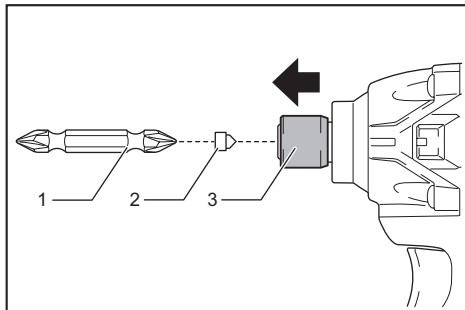

► 1. Driver bit 2. Bit-piece 3. Sleeve

To remove the driver bit, pull the sleeve in the direction of the arrow and pull the driver bit out.

**NOTE:** If the driver bit is not inserted deep enough into the sleeve, the sleeve will not return to its original position and the driver bit will not be secured. In this case, try re-inserting the bit according to the instructions above.

**NOTE:** When it is difficult to insert the driver bit, pull the sleeve and insert it into the sleeve as far as it will go.

**NOTE:** After inserting the driver bit, make sure that it is firmly secured. If it comes out, do not use it.

## Installing hook

**CAUTION:** When installing the hook, always secure it with the screw firmly. If not, the hook may come off from the tool and result in the personal injury.

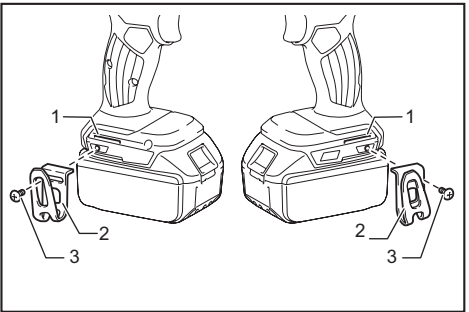

► 1. Groove 2. Hook 3. Screw

The hook is convenient for temporarily hanging the tool. This can be installed on either side of the tool. To install the hook, insert it into a groove in the tool housing on either side and then secure it with a screw. To remove, loosen the screw and then take it out.

## OPERATION

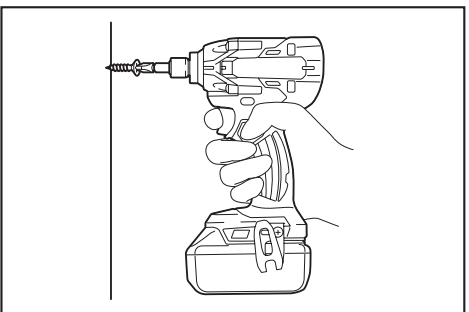

The proper fastening torque may differ depending upon the kind or size of the screw/bolt, the material of the workpiece to be fastened, etc. The relation between fastening torque and fastening time is shown in the figures.

### Proper fastening torque for standard bolt

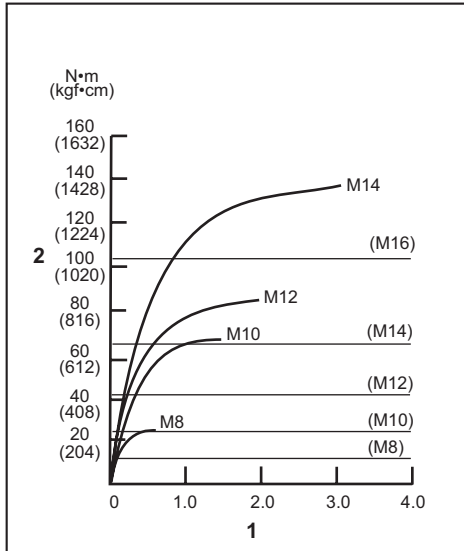

1. Fastening time (second) 2. Fastening torque

### Proper fastening torque for high tensile bolt

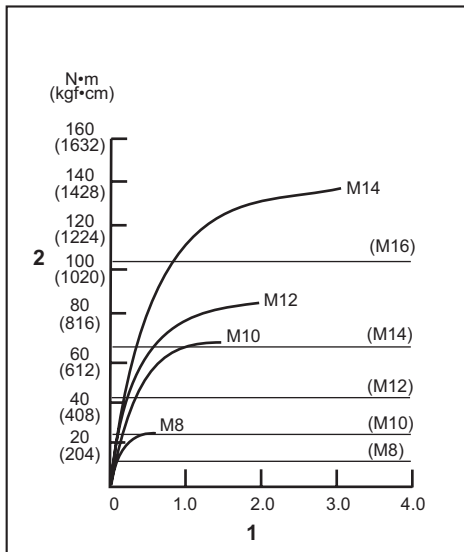

1. Fastening time (second) 2. Fastening torque

Hold the tool firmly and place the point of the driver bit in the screw head. Apply forward pressure to the tool to the extent that the bit will not slip off the screw and turn the tool on to start operation.

**NOTICE:** If you use a spare battery to continue the operation, rest the tool at least 15 min.

**NOTE:** Use the proper bit for the head of the screw/bolt that you wish to use.

**NOTE:** When fastening M8 or smaller screw, carefully adjust pressure on the switch trigger so that the screw is not damaged.

**NOTE:** Hold the tool pointed straight at the screw.

**NOTE:** If the impact force is too strong or you tighten the screw for a time longer than shown in the figures, the screw or the point of the driver bit may be overstressed, stripped, damaged, etc. Before starting your job, always perform a test operation to determine the proper fastening time for your screw.

The fastening torque is affected by a wide variety of factors including the following. After fastening, always check the torque with a torque wrench.

1. When the battery cartridge is discharged almost completely, voltage will drop and the fastening torque will be reduced.
2. Driver bit or socket bit  
Failure to use the correct size driver bit or socket bit will cause a reduction in the fastening torque.
3. Bolt
  - Even though the torque coefficient and the class of bolt are the same, the proper fastening torque will differ according to the diameter of bolt.
  - Even though the diameters of bolts are the same, the proper fastening torque will differ according to the torque coefficient, the class of bolt and the bolt length.
4. The manner of holding the tool or the material of driving position to be fastened will affect the torque.
5. Operating the tool at low speed will cause a reduction in the fastening torque.

## MAINTENANCE

**CAUTION:** Always be sure that the tool is switched off and the battery cartridge is removed before attempting to perform inspection or maintenance.

**NOTICE:** Never use gasoline, benzine, thinner, alcohol or the like. Discoloration, deformation or cracks may result.

To maintain product SAFETY and RELIABILITY, repairs, carbon brush inspection and replacement, any other maintenance or adjustment should be performed by Makita Authorized or Factory Service Centers, always using Makita replacement parts.

# OPTIONAL ACCESSORIES

**⚠ CAUTION:** These accessories or attachments are recommended for use with your Makita tool specified in this manual. The use of any other accessories or attachments might present a risk of injury to persons. Only use accessory or attachment for its stated purpose.

If you need any assistance for more details regarding these accessories, ask your local Makita Service Center.

- Driver bits
- Bit piece
- Hook
- Plastic carrying case
- Makita genuine battery and charger
- Battery protector

**NOTE:** Some items in the list may be included in the tool package as standard accessories. They may differ from country to country.



**Makita Europe N.V.** Jan-Baptist Vinkstraat 2,  
3070 Kortenberg, Belgium

**Makita Corporation** 3-11-8, Sumiyoshi-cho,  
Anjo, Aichi 446-8502 Japan

[www.makita.com](http://www.makita.com)

885747-221 EN 20190801
------------------------------



INSTRUCTION MANUAL



# Cordless Angle Grinder

DGA402  
DGA450  
DGA452

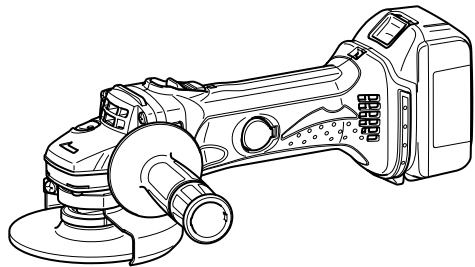

007214

**IMPORTANT:** Read Before Using.

## ENGLISH (Original instructions)

# SPECIFICATIONS

Model	DGA402	DGA450	DGA452
Wheel diameter	100 mm	115 mm	
Max. wheel thickness	6.4 mm	6.4 mm	6.4 mm
Spindle thread	M10	M14 or 5/8" (country specific)	
Rated speed (n) / No load speed (n <sub>0</sub> )	11,000 (min <sup>-1</sup> )		
Overall length	317 mm		
Net weight	2.2 kg	2.2 kg	2.3 kg
Rated voltage	D.C. 18 V	D.C. 14.4 V	D.C. 18 V

- Due to our continuing program of research and development, the specifications herein are subject to change without notice.
- Specifications and battery cartridge may differ from country to country.
- Weight, with battery cartridge, according to EPTA-Procedure 01/2003

END221-4

ENG905-1

## Symbols

The following show the symbols used for the equipment. Be sure that you understand their meaning before use.



- Read instruction manual.



- Wear safety glasses.



- Only for EU countries  
Do not dispose of electric equipment or battery pack together with household waste material!

In observance of the European Directives, on Waste Electric and Electronic Equipment and Batteries and Accumulators and Waste Batteries and Accumulators and their implementation in accordance with national laws, electric equipment and batteries and battery pack(s) that have reached the end of their life must be collected separately and returned to an environmentally compatible recycling facility.

ENE048-1

## Intended use

The tool is intended for grinding, sanding and cutting of metal and stone materials without the use of water.

## Noise

The typical A-weighted noise level determined according to EN60745:

### Model DGA450

Sound pressure level (L<sub>pA</sub>) : 74 dB (A)

Uncertainty (K) : 3 dB (A)

The noise level under working may exceed 80 dB (A).

### Model DGA452

Sound pressure level (L<sub>pA</sub>) : 76 dB (A)

Uncertainty (K) : 3 dB (A)

The noise level under working may exceed 80 dB (A).

## Wear ear protection

ENG900-1

## Vibration

The vibration total value (tri-axial vector sum) determined according to EN60745:

### Model DGA450

Work mode : surface grinding

Vibration emission (a<sub>h,AG</sub>) : 8.5 m/s<sup>2</sup>

Uncertainty (K) : 1.5 m/s<sup>2</sup>

Work mode: disc sanding

Vibration emission (a<sub>h,DS</sub>) : 2.5 m/s<sup>2</sup> or less

Uncertainty (K) : 1.5 m/s<sup>2</sup>

### Model DGA452

Work mode : surface grinding

Vibration emission (a<sub>h,AG</sub>) : 10.0 m/s<sup>2</sup>

Uncertainty (K) : 1.5 m/s<sup>2</sup>

Work mode: disc sanding

Vibration emission (a<sub>h,DS</sub>) : 2.5 m/s<sup>2</sup> or less

Uncertainty (K) : 1.5 m/s<sup>2</sup>

- The declared vibration emission value has been measured in accordance with the standard test method and may be used for comparing one tool with another.
- The declared vibration emission value may also be used in a preliminary assessment of exposure.
- The declared vibration emission value is used for main applications of the power tool. However if the power tool is used for other applications, the vibration emission value may be different.

**⚠ WARNING:**

- The vibration emission during actual use of the power tool can differ from the declared emission value depending on the ways in which the tool is used.
- Be sure to identify safety measures to protect the operator that are based on an estimation of exposure in the actual conditions of use (taking account of all parts of the operating cycle such as the times when the tool is switched off and when it is running idle in addition to the trigger time).

ENH101-16

**For European countries only**

**EC Declaration of Conformity**

**We Makita Corporation as the responsible manufacturer declare that the following Makita machine(s):**

Designation of Machine:

Cordless Angle Grinder

Model No./ Type: DGA450,DGA452

are of series production and

**Conforms to the following European Directives:**  
2006/42/EC

And are manufactured in accordance with the following standards or standardised documents:

EN60745

The technical documentation is kept by:

Makita International Europe Ltd.

Technical Department,

Michigan Drive, Tongwell,

Milton Keynes, Bucks MK15 8JD, England

30.1.2009



Tomoyasu Kato

Director

Makita Corporation

3-11-8, Sumiyoshi-cho,

Anjo, Aichi, 446-8502, JAPAN

000230

## General Power Tool Safety Warnings

**⚠ WARNING** Read all safety warnings and all instructions. Failure to follow the warnings and instructions may result in electric shock, fire and/or serious injury.

### Save all warnings and instructions for future reference.

The term "power tool" in the warnings refers to your mains-operated (corded) power tool or battery-operated (cordless) power tool.

#### Work area safety

1. **Keep work area clean and well lit.** Cluttered or dark areas invite accidents.
2. **Do not operate power tools in explosive atmospheres, such as in the presence of flammable liquids, gases or dust.** Power tools create sparks which may ignite the dust or fumes.
3. **Keep children and bystanders away while operating a power tool.** Distractions can cause you to lose control.

#### Electrical safety

4. **Power tool plugs must match the outlet. Never modify the plug in any way. Do not use any adapter plugs with earthed (grounded) power tools.** Unmodified plugs and matching outlets will reduce risk of electric shock.
5. **Avoid body contact with earthed or grounded surfaces such as pipes, radiators, ranges and refrigerators.** There is an increased risk of electric shock if your body is earthed or grounded.
6. **Do not expose power tools to rain or wet conditions.** Water entering a power tool will increase the risk of electric shock.
7. **Do not abuse the cord. Never use the cord for carrying, pulling or unplugging the power tool. Keep cord away from heat, oil, sharp edges or moving parts.** Damaged or entangled cords increase the risk of electric shock.
8. **When operating a power tool outdoors, use an extension cord suitable for outdoor use.** Use of a cord suitable for outdoor use reduces the risk of electric shock.
9. **If operating a power tool in a damp location is unavoidable, use a ground fault circuit interrupter (GFCI) protected supply.** Use of an GFCI reduces the risk of electric shock.

#### Personal safety

10. **Stay alert, watch what you are doing and use common sense when operating a power tool. Do not use a power tool while you are tired or under**

the influence of drugs, alcohol or medication. A moment of inattention while operating power tools may result in serious personal injury.

11. **Use personal protective equipment. Always wear eye protection.** Protective equipment such as dust mask, non-skid safety shoes, hard hat, or hearing protection used for appropriate conditions will reduce personal injuries.
12. **Prevent unintentional starting. Ensure the switch is in the off-position before connecting to power source and/or battery pack, picking up or carrying the tool.** Carrying power tools with your finger on the switch or energising power tools that have the switch on invites accidents.
13. **Remove any adjusting key or wrench before turning the power tool on.** A wrench or a key left attached to a rotating part of the power tool may result in personal injury.
14. **Do not overreach. Keep proper footing and balance at all times.** This enables better control of the power tool in unexpected situations.
15. **Dress properly. Do not wear loose clothing or jewellery. Keep your hair, clothing, and gloves away from moving parts.** Loose clothes, jewellery or long hair can be caught in moving parts.
16. **If devices are provided for the connection of dust extraction and collection facilities, ensure these are connected and properly used.** Use of dust collection can reduce dust-related hazards.

#### **Power tool use and care**

17. **Do not force the power tool. Use the correct power tool for your application.** The correct power tool will do the job better and safer at the rate for which it was designed.
18. **Do not use the power tool if the switch does not turn it on and off.** Any power tool that cannot be controlled with the switch is dangerous and must be repaired.
19. **Disconnect the plug from the power source and/or the battery pack from the power tool before making any adjustments, changing accessories, or storing power tools.** Such preventive safety measures reduce the risk of starting the power tool accidentally.
20. **Store idle power tools out of the reach of children and do not allow persons unfamiliar with the power tool or these instructions to operate the power tool.** Power tools are dangerous in the hands of untrained users.
21. **Maintain power tools. Check for misalignment or binding of moving parts, breakage of parts and any other condition that may affect the power tool's operation. If damaged, have the power tool repaired before use.** Many accidents are caused by poorly maintained power tools.

22. **Keep cutting tools sharp and clean.** Properly maintained cutting tools with sharp cutting edges are less likely to bind and are easier to control.
23. **Use the power tool, accessories and tool bits etc. in accordance with these instructions, taking into account the working conditions and the work to be performed.** Use of the power tool for operations different from those intended could result in a hazardous situation.

#### **Battery tool use and care**

24. **Recharge only with the charger specified by the manufacturer.** A charger that is suitable for one type of battery pack may create a risk of fire when used with another battery pack.
25. **Use power tools only with specifically designated battery packs.** Use of any other battery packs may create a risk of injury and fire.
26. **When battery pack is not in use, keep it away from other metal objects, like paper clips, coins, keys, nails, screws or other small metal objects, that can make a connection from one terminal to another.** Shorting the battery terminals together may cause burns or a fire.
27. **Under abusive conditions, liquid may be ejected from the battery; avoid contact. If contact accidentally occurs, flush with water. If liquid contacts eyes, additionally seek medical help.** Liquid ejected from the battery may cause irritation or burns.

#### **Service**

28. **Have your power tool serviced by a qualified repair person using only identical replacement parts.** This will ensure that the safety of the power tool is maintained.
29. **Follow instruction for lubricating and changing accessories.**
30. **Keep handles dry, clean and free from oil and grease.**

GEB059-3

## **CORDLESS GRINDER SAFETY WARNINGS**

**Safety Warnings Common for Grinding, Sanding, Wire Brushing, or Abrasive Cutting-Off Operations:**

1. This power tool is intended to function as a grinder, sander, wire brush or cut-off tool. Read all safety warnings, instructions, illustrations and specifications provided with this power tool. Failure to follow all instructions listed below may result in electric shock, fire and/or serious injury.
2. Operations such as polishing are not recommended to be performed with this power tool. Operations for which the power tool was not designed may create a hazard and cause

- personal injury.
3. **Do not use accessories which are not specifically designed and recommended by the tool manufacturer.** Just because the accessory can be attached to your power tool, it does not assure safe operation.
  4. **The rated speed of the accessory must be at least equal to the maximum speed marked on the power tool.** Accessories running faster than their rated speed can break and fly apart.
  5. **The outside diameter and the thickness of your accessory must be within the capacity rating of your power tool.** Incorrectly sized accessories cannot be adequately guarded or controlled.
  6. **Threaded mounting of accessories must match the grinder spindle thread. For accessories mounted by flanges, the arbour hole of the accessory must fit the locating diameter of the flange.** Accessories that do not match the mounting hardware of the power tool will run out of balance, vibrate excessively and may cause loss of control.
  7. **Do not use a damaged accessory. Before each use inspect the accessory such as abrasive wheels for chips and cracks, backing pad for cracks, tear or excess wear, wire brush for loose or cracked wires. If power tool or accessory is dropped, inspect for damage or install an undamaged accessory. After inspecting and installing an accessory, position yourself and bystanders away from the plane of the rotating accessory and run the power tool at maximum no-load speed for one minute. Damaged accessories will normally break apart during this test time.**
  8. **Wear personal protective equipment. Depending on application, use face shield, safety goggles or safety glasses. As appropriate, wear dust mask, hearing protectors, gloves and workshop apron capable of stopping small abrasive or workpiece fragments.** The eye protection must be capable of stopping flying debris generated by various operations. The dust mask or respirator must be capable of filtering particles generated by your operation. Prolonged exposure to high intensity noise may cause hearing loss.
  9. **Keep bystanders a safe distance away from work area. Anyone entering the work area must wear personal protective equipment.** Fragments of workpiece or of a broken accessory may fly away and cause injury beyond immediate area of operation.
  10. **Hold the power tool by insulated gripping surfaces only, when performing an operation where the cutting tool may contact hidden wiring.** Contact with a "live" wire will also make exposed metal parts of the power tool "live" and could give the operator an electric shock.
  11. **Never lay the power tool down until the accessory has come to a complete stop.** The spinning accessory may grab the surface and pull the power tool out of your control.
  12. **Do not run the power tool while carrying it at your side.** Accidental contact with the spinning accessory could snag your clothing, pulling the accessory into your body.
  13. **Regularly clean the power tool's air vents.** The motor's fan will draw the dust inside the housing and excessive accumulation of powdered metal may cause electrical hazards.
  14. **Do not operate the power tool near flammable materials.** Sparks could ignite these materials.
  15. **Do not use accessories that require liquid coolants.** Using water or other liquid coolants may result in electrocution or shock.
- Kickback and Related Warnings**
- Kickback is a sudden reaction to a pinched or snagged rotating wheel, backing pad, brush or any other accessory. Pinching or snagging causes rapid stalling of the rotating accessory which in turn causes the uncontrolled power tool to be forced in the direction opposite of the accessory's rotation at the point of the binding. For example, if an abrasive wheel is snagged or pinched by the workpiece, the edge of the wheel that is entering into the pinch point can dig into the surface of the material causing the wheel to climb out or kick out. The wheel may either jump toward or away from the operator, depending on direction of the wheel's movement at the point of pinching. Abrasive wheels may also break under these conditions.
- Kickback is the result of power tool misuse and/or incorrect operating procedures or conditions and can be avoided by taking proper precautions as given below.
- a) **Maintain a firm grip on the power tool and position your body and arm to allow you to resist kickback forces. Always use auxiliary handle, if provided, for maximum control over kickback or torque reaction during start-up.** The operator can control torque reactions or kickback forces, if proper precautions are taken.
  - b) **Never place your hand near the rotating accessory.** Accessory may kickback over your hand.
  - c) **Do not position your body in the area where power tool will move if kickback occurs.** Kickback will propel the tool in direction opposite to the wheel's movement at the point of snagging.
  - d) **Use special care when working corners, sharp edges etc. Avoid bouncing and snagging the accessory.** Corners, sharp edges or bouncing

have a tendency to snag the rotating accessory and cause loss of control or kickback.

e) **Do not attach a saw chain woodcarving blade or toothed saw blade.** Such blades create frequent kickback and loss of control.

#### **Safety Warnings Specific for Grinding and Abrasive Cutting-Off Operations:**

a) **Use only wheel types that are recommended for your power tool and the specific guard designed for the selected wheel.** Wheels for which the power tool was not designed cannot be adequately guarded and are unsafe.

b) **The grinding surface of centre depressed wheels must be mounted below the plane of the guard lip.** An improperly mounted wheel that projects through the plane of the guard lip cannot be adequately protected.

c) **The guard must be securely attached to the power tool and positioned for maximum safety, so the least amount of wheel is exposed towards the operator.** The guard helps to protect the operator from broken wheel fragments, accidental contact with wheel and sparks that could ignite clothing.

d) **Wheels must be used only for recommended applications. For example: do not grind with the side of cut-off wheel.** Abrasive cut-off wheels are intended for peripheral grinding, side forces applied to these wheels may cause them to shatter.

e) **Always use undamaged wheel flanges that are of correct size and shape for your selected wheel.** Proper wheel flanges support the wheel thus reducing the possibility of wheel breakage. Flanges for cut-off wheels may be different from grinding wheel flanges.

f) **Do not use worn down wheels from larger power tools.** Wheel intended for larger power tool is not suitable for the higher speed of a smaller tool and may burst.

#### **Additional Safety Warnings Specific for Abrasive Cutting-Off Operations:**

a) **Do not “jam” the cut-off wheel or apply excessive pressure. Do not attempt to make an excessive depth of cut.** Overstressing the wheel increases the loading and susceptibility to twisting or binding of the wheel in the cut and the possibility of kickback or wheel breakage.

b) **Do not position your body in line with and behind the rotating wheel.** When the wheel, at the point of operation, is moving away from your body, the possible kickback may propel the spinning wheel and the power tool directly at you.

c) **When wheel is binding or when interrupting a cut for any reason, switch off the power tool and hold the power tool motionless until the**

**wheel comes to a complete stop. Never attempt to remove the cut-off wheel from the cut while the wheel is in motion otherwise kickback may occur.** Investigate and take corrective action to eliminate the cause of wheel binding.

d) **Do not restart the cutting operation in the workpiece. Let the wheel reach full speed and carefully re-enter the cut.** The wheel may bind, walk up or kickback if the power tool is restarted in the workpiece.

e) **Support panels or any oversized workpiece to minimize the risk of wheel pinching and kickback.** Large workpieces tend to sag under their own weight. Supports must be placed under the workpiece near the line of cut and near the edge of the workpiece on both sides of the wheel.

f) **Use extra caution when making a “pocket cut” into existing walls or other blind areas.** The protruding wheel may cut gas or water pipes, electrical wiring or objects that can cause kickback.

#### **Safety Warnings Specific for Sanding Operations:**

a) **Do not use excessively oversized sanding disc paper. Follow manufacturers recommendations, when selecting sanding paper.** Larger sanding paper extending beyond the sanding pad presents a laceration hazard and may cause snagging, tearing of the disc or kickback.

#### **Safety Warnings Specific for Wire Brushing Operations:**

a) **Be aware that wire bristles are thrown by the brush even during ordinary operation. Do not overstress the wires by applying excessive load to the brush.** The wire bristles can easily penetrate light clothing and/or skin.

b) **If the use of a guard is recommended for wire brushing, do not allow interference of the wire wheel or brush with the guard.** Wire wheel or brush may expand in diameter due to work load and centrifugal forces.

#### **Additional Safety Warnings:**

16. **When using depressed centre grinding wheels, be sure to use only fiberglass-reinforced wheels.**
17. **NEVER USE Stone Cup type wheels with this grinder.** This grinder is not designed for these types of wheels and the use of such a product may result in serious personal injury.
18. **Be careful not to damage the spindle, the flange (especially the installing surface) or the lock nut. Damage to these parts could result in wheel breakage.**
19. **Make sure the wheel is not contacting the workpiece before the switch is turned on.**
20. **Before using the tool on an actual workpiece, let it run for a while. Watch for vibration or**

- wobbling that could indicate poor installation or a poorly balanced wheel.
21. Use the specified surface of the wheel to perform the grinding.
  22. Do not leave the tool running. Operate the tool only when hand-held.
  23. Do not touch the workpiece immediately after operation; it may be extremely hot and could burn your skin.
  24. Observe the instructions of the manufacturer for correct mounting and use of wheels. Handle and store wheels with care.
  25. Do not use separate reducing bushings or adaptors to adapt large hole abrasive wheels.
  26. Use only flanges specified for this tool.
  27. For tools intended to be fitted with threaded hole wheel, ensure that the thread in the wheel is long enough to accept the spindle length.
  28. Check that the workpiece is properly supported.
  29. Pay attention that the wheel continues to rotate after the tool is switched off.
  30. If working place is extremely hot and humid, or badly polluted by conductive dust, use a short-circuit breaker (30 mA) to assure operator safety.
  31. Do not use the tool on any materials containing asbestos.
  32. When use cut-off wheel, always work with the dust collecting wheel guard required by domestic regulation.
  33. Cutting discs must not be subjected to any lateral pressure.

## SAVE THESE INSTRUCTIONS.

### WARNING:

DO NOT let comfort or familiarity with product (gained from repeated use) replace strict adherence to safety rules for the subject product. MISUSE or failure to follow the safety rules stated in this instruction manual may cause serious personal injury.

ENC007-8

## IMPORTANT SAFETY INSTRUCTIONS

### FOR BATTERY CARTRIDGE

1. Before using battery cartridge, read all instructions and cautionary markings on (1) battery charger, (2) battery, and (3) product using battery.
2. Do not disassemble battery cartridge.
3. If operating time has become excessively shorter, stop operating immediately. It may result in a risk of overheating, possible burns and even an explosion.
4. If electrolyte gets into your eyes, rinse them out with clear water and seek medical attention right away. It may result in loss of your eyesight.
5. Do not short the battery cartridge:
  - (1) Do not touch the terminals with any conductive material.
  - (2) Avoid storing battery cartridge in a container with other metal objects such as nails, coins, etc.
  - (3) Do not expose battery cartridge to water or rain.

A battery short can cause a large current flow, overheating, possible burns and even a breakdown.
6. Do not store the tool and battery cartridge in locations where the temperature may reach or exceed 50 ° C (122 ° F).
7. Do not incinerate the battery cartridge even if it is severely damaged or is completely worn out. The battery cartridge can explode in a fire.
8. Be careful not to drop or strike battery.
9. Do not use a damaged battery.
10. Follow your local regulations relating to disposal of battery.

## SAVE THESE INSTRUCTIONS.

### Tips for maintaining maximum battery life

1. Charge the battery cartridge before completely discharged. Always stop tool operation and charge the battery cartridge when you notice less tool power.
2. Never recharge a fully charged battery cartridge. Overcharging shortens the battery service life.
3. Charge the battery cartridge with room temperature at 10 ° C - 40 ° C (50 ° F - 104 ° F). Let a hot battery cartridge cool down before charging it.
4. Charge the battery cartridge once in every six months if you do not use it for a long period of time.

## FUNCTIONAL DESCRIPTION

### ⚠CAUTION:

- Always be sure that the tool is switched off and the battery cartridge is removed before adjusting or checking function on the tool.

### Installing or removing battery cartridge

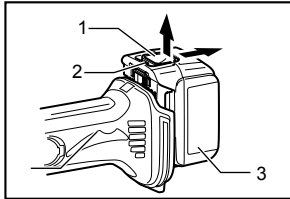

1. Button
2. Red indicator
3. Battery cartridge

013993

### ⚠CAUTION:

- Always switch off the tool before installing or removing of the battery cartridge.
- **Hold the tool and the battery cartridge firmly when installing or removing battery cartridge.** Failure to hold the tool and the battery cartridge firmly may cause them to slip off your hands and result in damage to the tool and battery cartridge and a personal injury.

To remove the battery cartridge, slide it from the tool while sliding the button on the front of the cartridge.

To install the battery cartridge, align the tongue on the battery cartridge with the groove in the housing and slip it into place. Insert it all the way until it locks in place with a little click. If you can see the red indicator on the upper side of the button, it is not locked completely.

### ⚠CAUTION:

- Always install the battery cartridge fully until the red indicator cannot be seen. If not, it may accidentally fall out of the tool, causing injury to you or someone around you.
- Do not install the battery cartridge forcibly. If the cartridge does not slide in easily, it is not being inserted correctly.

### Battery protection system

The tool is equipped with a battery protection system. This system automatically cuts off power to the motor to extend battery life.

The tool will automatically stop during operation if the tool and/or battery are placed under one of the following conditions:

- **Overloaded:**  
The tool is operated in a manner that causes it to draw an abnormally high current.

In this situation, turn the tool off and stop the application that caused the tool to become overloaded. Then turn the tool on to restart.

If the tool does not start, the battery is overheated. In this situation, let the battery cool before turning the tool on again.

- **Low battery voltage:**  
The remaining battery capacity is too low and the tool will not operate. In this situation, remove and recharge the battery.

### NOTE:

The overheat protection works only with a battery cartridge with a star mark.

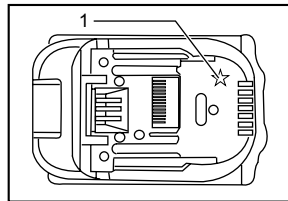

1. Star marking

012126

### Indication lamp with multi function

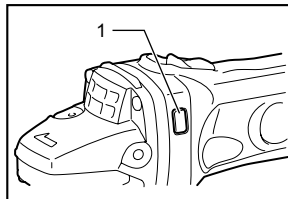

1. Indication lamp

007224

Indication lamps are located in two positions.

When the battery cartridge is inserted on the tool with the slide switch positioned in the "O (OFF)", the indication lamp flickers quickly for approximately one second. If it does not flicker so, the battery cartridge or indication lamp may be broken.

#### - **Overload protection**

- When the tool becomes overloaded, the indication lamp lights up. When the load on the tool is reduced, the lamp goes out.
- If the tool continues to be overloaded and the indication lamp continues to light up for approximately two seconds, the tool stops. This prevents the motor and its related parts from being damaged.
- In this situation, move the slide switch to the "O (OFF)" position once. And then move it to the "I (ON)" position again to restart.



- **Battery cartridge replacing signal**
  - When the remaining battery capacity is low, the indicator lamp lights up during operation earlier than that of high battery capacity.
- **Accidental re-start preventive function**
  - Even if the battery cartridge is inserted on the tool with the slide switch in the "I (ON)" position, the tool does not start. In this situation, the lamp flickers slowly. It indicates that the accidental re-start preventive function is at work.
  - To start the tool, first slide the slide switch toward the "O (OFF)" position and then slide it toward the "I (ON)" position.

### Shaft lock

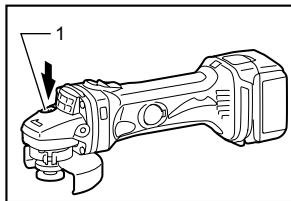

007216

1. Shaft lock

#### ⚠CAUTION:

- Never actuate the shaft lock when the spindle is moving. The tool may be damaged.

Press the shaft lock to prevent spindle rotation when installing or removing accessories.

### Switch action

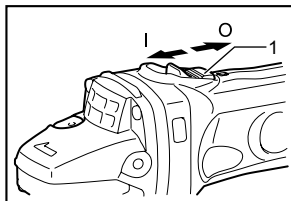

007217

1. Slide switch

#### ⚠CAUTION:

- Before inserting the battery cartridge into the tool, always check to see that the slide switch actuates properly and returns to the "OFF" position when the rear of the slide switch is depressed.

To start the tool, slide the slide switch toward the "I (ON)" position. For continuous operation, press the front of the slide switch to lock it.

To stop the tool, press the rear of the slide switch, then slide it toward the "O (OFF)" position.

## ASSEMBLY

#### ⚠CAUTION:

- Always be sure that the tool is switched off and the battery cartridge is removed before carrying out any work on the tool.

### Installing side grip (handle)

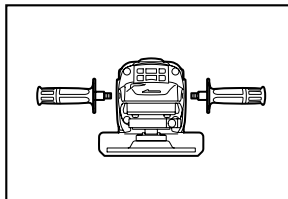

007225

#### ⚠CAUTION:

- Always be sure that the side grip is installed securely before operation.

Screw the side grip securely on the position of the tool as shown in the figure.

### Installing or removing wheel guard (For depressed center wheel, multi disc / abrasive cut-off wheel, diamond wheel) For tool with locking screw type wheel guard

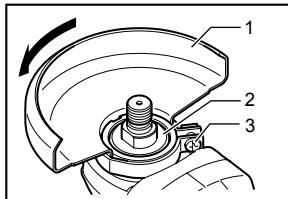

007218

1. Wheel guard  
2. Bearing box  
3. Screw

#### ⚠WARNING:

- When using a depressed center grinding wheel/Multi-disc, flex wheel, wire wheel brush, cut-off wheel or diamond wheel, the wheel guard must be fitted on the tool so that the closed side of the guard always points toward the operator.
- When using an abrasive cut-off / diamond wheel, be sure to use only the special wheel guard designed for use with cut-off wheels. (In European countries, when using a diamond wheel, the ordinary guard can be used.)

Mount the wheel guard with the protrusion on the wheel guard band aligned with the notch on the bearing box. Then rotate the wheel guard to such an angle that it can protect the operator according to work. Be sure to tighten the screw securely.

To remove wheel guard, follow the installation procedure in reverse.

### Installing or removing depressed center grinding wheel/Multi-disc

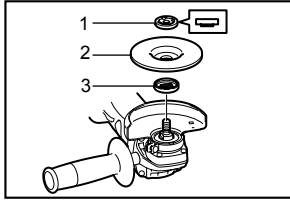

007219

1. Lock nut
2. Depressed center grinding wheel/Multi-disc
3. Inner flange

#### ⚠WARNING:

- Always use supplied guard when depressed center grinding wheel/Multi-disc is on tool. Wheel can shatter during use and guard helps to reduce chances of personal injury.

Mount the inner flange onto the spindle. Fit the wheel/disc on the inner flange and screw the lock nut onto the spindle.

To tighten the lock nut, press the shaft lock firmly so that the spindle cannot revolve, then use the lock nut wrench and securely tighten clockwise.

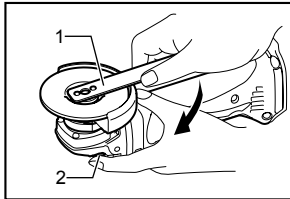

007220

1. Lock nut wrench
2. Shaft lock

To remove the wheel, follow the installation procedure in reverse.

#### ⚠WARNING:

Only actuate the shaft lock when the spindle is not moving.

## OPERATION

#### ⚠WARNING:

- It should never be necessary to force the tool. The weight of the tool applies adequate pressure. Forcing and excessive pressure could cause dangerous wheel breakage.
- ALWAYS replace wheel if tool is dropped while grinding.
- NEVER bang or hit grinding disc or wheel onto work.
- Avoid bouncing and snagging the wheel, especially when working corners, sharp edges etc. This can cause loss of control and kickback.
- NEVER use tool with wood cutting blades and other sawblades. Such blades when used on a grinder frequently kick and cause loss of control leading to personal injury.

#### ⚠CAUTION:

- Make the depth of a single cut up to 5 mm. Adjust pressure on the tool so that the tool does not slow down during the operation.
- After operation, always switch off the tool and wait until the wheel has come to a complete stop before putting the tool down.
- If the tool is operated continuously until the battery cartridge has discharged, allow the tool to rest for 15 minutes before proceeding with a fresh battery.

### Grinding and sanding operation

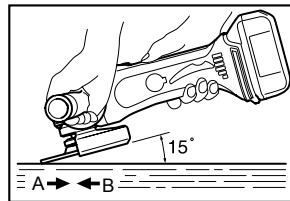

007221

ALWAYS hold the tool firmly with one hand on housing and the other on the side handle. Turn the tool on and then apply the wheel or disc to the workpiece.

In general, keep the edge of the wheel or disc at an angle of about 15 degrees to the workpiece surface.

During the break-in period with a new wheel, do not work the grinder in the B direction or it will cut into the workpiece. Once the edge of the wheel has been rounded off by use, the wheel may be worked in both A and B direction.

**Operation with abrasive cut-off / diamond wheel (optional accessory)**

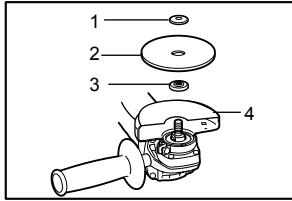

- 1. Lock nut
- 2. Abrasive cut-off wheel/diamond wheel
- 3. Inner flange
- 4. Wheel guard for abrasive cut-off wheel/diamond wheel

010855

The direction for mounting the lock nut and the inner flange varies by wheel thickness. Refer to the table below.

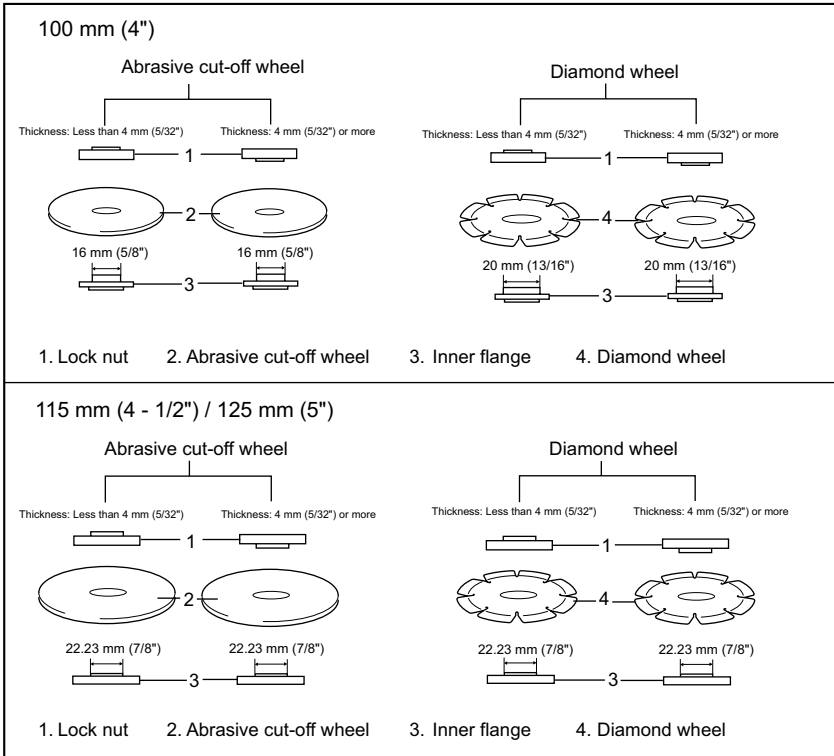

010848

**⚠WARNING:**

- When using an abrasive cut-off / diamond wheel, be sure to use only the special wheel guard designed for use with cut-off wheels. (In European countries, when using a diamond wheel, the ordinary guard can be used.)
- NEVER use cut-off wheel for side grinding.
- Do not "jam" the wheel or apply excessive pressure. Do not attempt to make an excessive depth of cut. Overstressing the wheel increases the loading and susceptibility to twisting or binding of the wheel in the cut and the possibility of kickback, wheel breakage and overheating of the motor may occur.
- Do not start the cutting operation in the workpiece. Let the wheel reach full speed and carefully enter into the cut moving the tool forward over the workpiece surface. The wheel may bind, walk up or kickback if the power tool is started in the workpiece.
- During cutting operations, never change the angle of the wheel. Placing side pressure on the cut-off wheel (as in grinding) will cause the wheel to crack and break, causing serious personal injury.
- A diamond wheel shall be operated perpendicular to the material being cut.

## MAINTENANCE

**⚠CAUTION:**

- Always be sure that the tool is switched off and the battery cartridge is removed before attempting to perform inspection or maintenance.
- Never use gasoline, benzine, thinner, alcohol or the like. Discoloration, deformation or cracks may result.

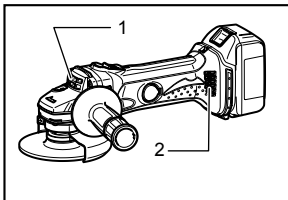

1. Exhaust vent
2. Inhalation vent

007222

The tool and its air vents have to be kept clean. Regularly clean the tool's air vents or whenever the vents start to become obstructed.

## Replacing carbon brushes

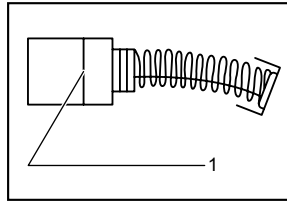

1. Limit mark

001145

Remove and check the carbon brushes regularly. Replace when they wear down to the limit mark. Keep the carbon brushes clean and free to slip in the holders. Both carbon brushes should be replaced at the same time. Use only identical carbon brushes. Insert the top end of slotted bit screwdriver into the notch in the tool and remove the holder cap cover by lifting it up.

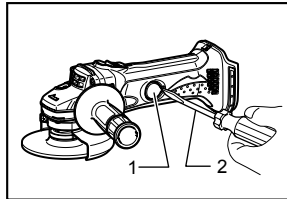

1. Holder cap cover
2. Screwdriver

007226

Use a screwdriver to remove the brush holder caps. Take out the worn carbon brushes, insert the new ones and secure the brush holder caps.

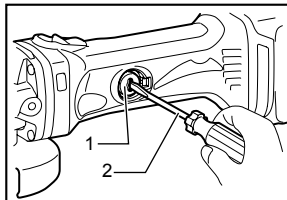

1. Brush holder cap
2. Screwdriver

007223

Reinstall the holder cap cover on the tool. To maintain product SAFETY and RELIABILITY, repairs, any other maintenance or adjustment should be performed by Makita Authorized Service Centers, always using Makita replacement parts.

---

## OPTIONAL ACCESSORIES

### CAUTION:

- These accessories or attachments are recommended for use with your Makita tool specified in this manual. The use of any other accessories or attachments might present a risk of injury to persons. Only use accessory or attachment for its stated purpose.

If you need any assistance for more details regarding these accessories, ask your local Makita Service Center.

- Wheel guard (wheel cover) For depressed center wheel / multi disc
- Wheel guard (wheel cover) For abrasive cut-off wheel / diamond wheel
- Depressed center wheels
- Abrasive cut-off wheels
- Multi discs
- Diamond wheels
- Wire cup brushes
- Wire bevel brush 85
- Abrasive discs
- Inner flange
- Lock nut for depressed center wheel / abrasive cut-off wheel / multi disc / diamond wheel
- Lock nut for abrasive disc
- Lock nut wrench
- Side grip
- Makita genuine battery and charger

### NOTE:

- Some items in the list may be included in the tool package as standard accessories. They may differ from country to country.





**Makita Corporation**  
Anjo, Aichi, Japan

885268A223

[www.makita.com](http://www.makita.com)



INSTRUCTION MANUAL



# Cordless Recipro Saw

## DJR186

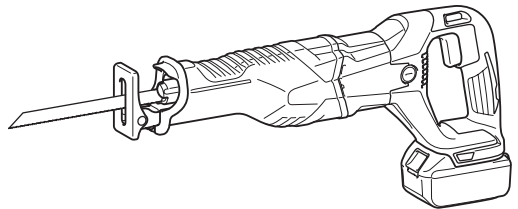

Read before use.

Created with



**nitro**<sup>PDF</sup> professional

download the free trial online at [nitropdf.com/professional](https://www.nitropdf.com/professional)

# SPECIFICATIONS

<b>Model:</b>		<b>DJR186</b>	
Length of stroke		32 mm	
Strokes per minute		0 - 2,800 min <sup>-1</sup>	
Max. cutting capacities	Pipe	130 mm	
	Wood	255 mm	
Rated voltage		D.C. 18 V	
Battery cartridge		BL1815N, BL1820, BL1820B	BL1830, BL1830B, BL1840, BL1840B, BL1850, BL1850B, BL1860B
Overall length		486 mm	
Net weight		3.5 kg	3.8 kg

- Due to our continuing program of research and development, the specifications herein are subject to change without notice.
- Specifications and battery cartridge may differ from country to country.
- Weight, with battery cartridge, according to EPTA-Procedure 01/2003

## Symbols

The following show the symbols used for the equipment. Be sure that you understand their meaning before use.



Read instruction manual.



Cd  
Ni-MH  
Li-ion

Only for EU countries  
Do not dispose of electric equipment or battery pack together with household waste material!  
In observance of the European Directives, on Waste Electric and Electronic Equipment and Batteries and Accumulators and their implementation in accordance with national laws, electric equipment and batteries and battery pack(s) that have reached the end of their life must be collected separately and returned to an environmentally compatible recycling facility.

## Intended use

The tool is intended for sawing wood, plastic and ferrous materials.

## Noise

The typical A-weighted noise level determined according to EN60745:

Sound pressure level ( $L_{pA}$ ) : 84 dB(A)

Sound power level ( $L_{WA}$ ) : 95 dB (A)

Uncertainty (K) : 3 dB(A)

**WARNING: Wear ear protection.**

## Vibration

The vibration total value (tri-axial vector sum) determined according to EN60745:

Work mode: cutting boards

Vibration emission ( $a_{hWB}$ ) : 13.0 m/s<sup>2</sup>

Uncertainty (K) : 1.5 m/s<sup>2</sup>

Work mode: cutting wooden beams

Vibration emission ( $a_{hWB}$ ) 12.5 m/s<sup>2</sup>  
Uncertainty (K) : 1.5 m/s<sup>2</sup>

**NOTE:** The declared vibration emission value has been measured in accordance with the standard test method and may be used for comparing one tool with another.

**NOTE:** The declared vibration emission value may also be used in a preliminary assessment of exposure.

**WARNING:** The vibration emission during actual use of the power tool can differ from the declared emission value depending on the ways in which the tool is used.

**WARNING:** Be sure to identify safety measures to protect the operator that are based on an estimation of exposure in the actual conditions of use (taking account of all parts of the operating cycle such as the times when the tool is switched off and when it is running idle in addition to the trigger time).

## EC Declaration of Conformity

### For European countries only

Makita declares that the following Machine(s):  
Designation of Machine: Cordless Recipro Saw  
Model No./ Type: DJR186

Conforms to the following European Directives:  
2006/42/EC

They are manufactured in accordance with the following standard or standardized documents: EN60745

The technical file in accordance with 2006/42/EC is available from:

Makita, Jan-Baptist Vinkstraat 2, 3070, Belgium  
24.4.2015

*Yasushi Fukaya*

Yasushi Fukaya  
Director

Makita, Jan-Baptist Vinkstraat 2, 3070, Belgium



**nitro** PDF

**professional**

download the free trial online at [nitropdf.com/professional](http://nitropdf.com/professional)

## General power tool safety warnings

**⚠ WARNING:** Read all safety warnings and all instructions. Failure to follow the warnings and instructions may result in electric shock, fire and/or serious injury.

### Save all warnings and instructions for future reference.

The term "power tool" in the warnings refers to your mains-operated (corded) power tool or battery-operated (cordless) power tool.

#### Work area safety

1. **Keep work area clean and well lit.** Cluttered or dark areas invite accidents.
2. **Do not operate power tools in explosive atmospheres, such as in the presence of flammable liquids, gases or dust.** Power tools create sparks which may ignite the dust or fumes.
3. **Keep children and bystanders away while operating a power tool.** Distractions can cause you to lose control.

#### Electrical Safety

1. **Power tool plugs must match the outlet. Never modify the plug in any way. Do not use any adapter plugs with earthed (grounded) power tools.** Unmodified plugs and matching outlets will reduce risk of electric shock.
2. **Avoid body contact with earthed or grounded surfaces such as pipes, radiators, ranges and refrigerators.** There is an increased risk of electric shock if your body is earthed or grounded.
3. **Do not expose power tools to rain or wet conditions.** Water entering a power tool will increase the risk of electric shock.
4. **Do not abuse the cord. Never use the cord for carrying, pulling or unplugging the power tool. Keep cord away from heat, oil, sharp edges or moving parts.** Damaged or entangled cords increase the risk of electric shock.
5. **When operating a power tool outdoors, use an extension cord suitable for outdoor use.** Use of a cord suitable for outdoor use reduces the risk of electric shock.
6. **If operating a power tool in a damp location is unavoidable, use a residual current device (RCD) protected supply.** Use of an RCD reduces the risk of electric shock.

#### Personal Safety

1. **Stay alert, watch what you are doing and use common sense when operating a power tool. Do not use a power tool while you are tired or under the influence of drugs, alcohol or medication.** A moment of inattention while operating power tools may result in serious personal injury.
2. **Use personal protective equipment. Always wear eye protection.** Protective equipment such as dust mask, non-skid safety shoes, hard hat, or hearing protection used for appropriate conditions will reduce personal injuries.
3. **Prevent unintentional starting. Ensure the switch is in the off-position before connecting to power source and/or battery pack, before picking up or carrying the tool. Carrying power tools with your finger on the switch or energising power tools that have the switch on invites accidents.**

4. **Remove any adjusting key or wrench before turning the power tool on.** A wrench or a key left attached to a rotating part of the power tool may result in personal injury.
5. **Do not overreach. Keep proper footing and balance at all times.** This enables better control of the power tool in unexpected situations.
6. **Dress properly. Do not wear loose clothing or jewellery. Keep your hair, clothing, and gloves away from moving parts.** Loose clothes, jewellery or long hair can be caught in moving parts.
7. **If devices are provided for the connection of dust extraction and collection facilities, ensure these are connected and properly used.** Use of dust collection can reduce dust-related hazards.

#### Power tool use and care

1. **Do not force the power tool. Use the correct power tool for your application.** The correct power tool will do the job better and safer at the rate for which it was designed.
2. **Do not use the power tool if the switch does not turn it on and off.** Any power tool that cannot be controlled with the switch is dangerous and must be repaired.
3. **Disconnect the plug from the power source and/or the battery pack from the power tool before making any adjustments, changing accessories, or storing power tools.** Such preventive safety measures reduce the risk of starting the power tool accidentally.
4. **Store idle power tools out of the reach of children and do not allow persons unfamiliar with the power tool or these instructions to operate the power tool.** Power tools are dangerous in the hands of untrained users.
5. **Maintain power tools. Check for misalignment or binding of moving parts, breakage of parts and any other condition that may affect the power tool's operation. If damaged, have the power tool repaired before use.** Many accidents are caused by poorly maintained power tools.
6. **Keep cutting tools sharp and clean.** Properly maintained cutting tools with sharp cutting edges are less likely to bind and are easier to control.
7. **Use the power tool, accessories and tool bits etc. in accordance with these instructions, taking into account the working conditions and the work to be performed.** Use of the power tool for operations different from those intended could result in a hazardous situation.

#### Battery tool use and care

1. **Recharge only with the charger specified by the manufacturer.** A charger that is suitable for one type of battery pack may create a risk of fire when used with another battery pack.
2. **Use power tools only with specifically designated battery packs.** Use of any other battery packs may create a risk of injury and fire.
3. **When battery pack is not in use, keep it away from other metal objects, like paper clips, coins, keys, nails, screws or other small metal objects, that can make a connection from one terminal to another. Shorting the battery terminals together may cause burns or a fire.**

download the free trial online at [nitropdf.com/professional](http://nitropdf.com/professional)

- Under abusive conditions, liquid may be ejected from the battery; avoid contact. If contact accidentally occurs, flush with water. If liquid contacts eyes, additionally seek medical help. Liquid ejected from the battery may cause irritation or burns.

#### Service

- Have your power tool serviced by a qualified repair person using only identical replacement parts. This will ensure that the safety of the power tool is maintained.
- Follow instruction for lubricating and changing accessories.
- Keep handles dry, clean and free from oil and grease.

### Cordless reciprocating saw safety warnings

- Hold power tool by insulated gripping surfaces, when performing an operation where the cutting accessory may contact hidden wiring. Cutting accessory contacting a "live" wire may make exposed metal parts of the power tool "live" and could give the operator an electric shock.
- Use clamps or another practical way to secure and support the workpiece to a stable platform. Holding the work by hand or against your body leaves it unstable and may lead to loss of control.
- Always use safety glasses or goggles. Ordinary eye or sun glasses are NOT safety glasses.
- Avoid cutting nails. Inspect workpiece for any nails and remove them before operation. Do not cut oversize workpiece.
- Check for the proper clearance beyond the workpiece before cutting so that the blade will not strike the floor, workbench, etc.
- Hold the tool firmly.
- Make sure the blade is not contacting the workpiece before the switch is turned on.
- Keep hands away from moving parts.
- Do not leave the tool running. Operate the tool only when hand-held.
- Always switch off and wait for the blade to come to a complete stop before removing the blade from the workpiece.
- Do not touch the blade or the workpiece immediately after operation; they may be extremely hot and could burn your skin.
- Do not operate the tool at no-load unnecessarily.
- Always use the correct dust mask/respirator for the material and application you are working with.
- Some material contains chemicals which may be toxic. Take caution to prevent dust inhalation and skin contact. Follow material supplier safety data.

## SAVE THESE INSTRUCTIONS.

**⚠ WARNING:** DO NOT let comfort or familiarity with product (gained from repeated use) replace strict adherence to safety rules for the subject product. MISUSE or failure to follow the safety rules stated in this instruction manual may cause serious personal injury.

### Important safety instructions for battery cartridge

- Before using battery cartridge, read all instructions and cautionary markings on (1) battery charger, (2) battery, and (3) product using battery.
- Do not disassemble battery cartridge.
- If operating time has become excessively shorter, stop operating immediately. It may result in a risk of overheating, possible burns and even an explosion.
- If electrolyte gets into your eyes, rinse them out with clear water and seek medical attention right away. It may result in loss of your eyesight.
- Do not short the battery cartridge:
  - Do not touch the terminals with any conductive material.
  - Avoid storing battery cartridge in a container with other metal objects such as nails, coins, etc.
  - Do not expose battery cartridge to water or rain.

A battery short can cause a large current flow, overheating, possible burns and even a breakdown.
- Do not store the tool and battery cartridge in locations where the temperature may reach or exceed 50 °C (122 °F).
- Do not incinerate the battery cartridge even if it is severely damaged or is completely worn out. The battery cartridge can explode in a fire.
- Be careful not to drop or strike battery.
- Do not use a damaged battery.
- The contained lithium-ion batteries are subject to the Dangerous Goods Legislation requirements.
 

For commercial transports e.g. by third parties, forwarding agents, special requirement on packaging and labeling must be observed. For preparation of the item being shipped, consulting an expert for hazardous material is required. Please also observe possibly more detailed national regulations.

Tape or mask off open contacts and pack up the battery in such a manner that it cannot move around in the packaging.
- Follow your local regulations relating to disposal of battery.



**nitro** PDF<sup>®</sup> professional

download the free trial online at [nitropdf.com/professional](http://nitropdf.com/professional)

## SAVE THESE INSTRUCTIONS.

**CAUTION:** Only use genuine Makita batteries. Use of non-genuine Makita batteries, or batteries that have been altered, may result in the battery bursting causing fires, personal injury and damage. It will also void the Makita warranty for the Makita tool and charger.

## Tips for maintaining maximum battery life

1. Charge the battery cartridge before completely discharged. Always stop tool operation and charge the battery cartridge when you notice less tool power.
2. Never recharge a fully charged battery cartridge. Overcharging shortens the battery service life.
3. Charge the battery cartridge with room temperature at 10 °C - 40 °C (50 °F - 104 °F). Let a hot battery cartridge cool down before charging it.
4. Charge the battery cartridge if you do not use it for a long period (more than six months).

## FUNCTIONAL DESCRIPTION

**CAUTION:** Always be sure that the tool is switched off and the battery cartridge is removed before adjusting or checking function on the tool.

## Installing or removing battery cartridge

**CAUTION:** Always switch off the tool before installing or removing of the battery cartridge.

**CAUTION:** Hold the tool and the battery cartridge firmly when installing or removing battery cartridge. Failure to hold the tool and the battery cartridge firmly may cause them to slip off your hands and result in damage to the tool and battery cartridge and a personal injury.

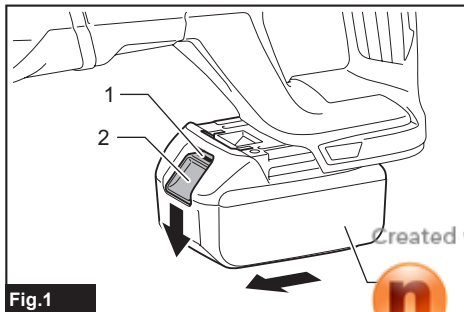

Fig.1

► 1. Red indicator 2. Button 3. Battery cartridge

To remove the battery cartridge, slide it from the tool while sliding the button on the front of the cartridge.

To install the battery cartridge, align the tongue on the battery cartridge with the groove in the housing and slip it into place. Insert it all the way until it locks in place with a little click. If you can see the red indicator on the upper side of the button, it is not locked completely.

**CAUTION:** Always install the battery cartridge fully until the red indicator cannot be seen. If not, it may accidentally fall out of the tool, causing injury to you or someone around you.

**CAUTION:** Do not install the battery cartridge forcibly. If the cartridge does not slide in easily, it is not being inserted correctly.

## Battery protection system

### Lithium-ion battery with star marking

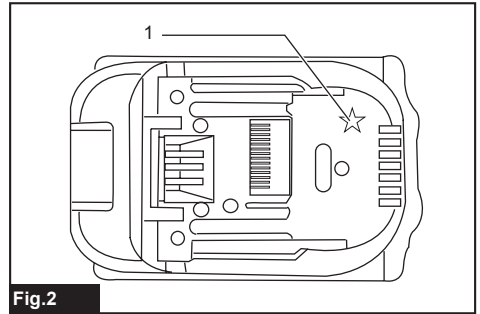

Fig.2

► 1. Star marking

Lithium-ion batteries with a star marking are equipped with a protection system. This system automatically cuts off power to the tool to extend battery life. The tool will automatically stop during operation if the tool and/or battery are placed under one of the following conditions:

### Overloaded:

The tool is operated in a manner that causes it to draw an abnormally high current. In this situation, turn the tool off and stop the application that caused the tool to become overloaded. Then turn the tool on to restart.

If the tool does not start, the battery is overheated. In this situation, let the battery cool before turning the tool on again.

### Low battery voltage:

The remaining battery capacity is too low and the tool will not operate. In this situation, remove and recharge the battery.

## Indicating the remaining battery capacity

Only for battery cartridges with "B" at the end of the model number

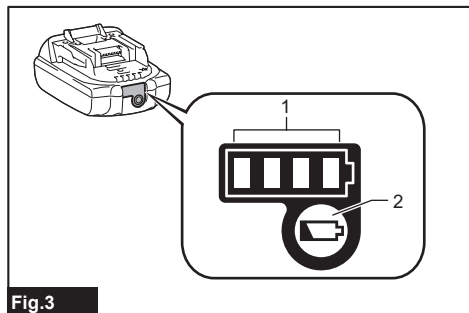

Fig.3

► 1. Indicator lamps 2. Check button

Press the check button on the battery cartridge to indicate the remaining battery capacity. The indicator lamps light up for few seconds.

Indicator lamps			Remaining capacity
Lighted	Off	Blinking	
■ ■ ■ ■			75% to 100%
■ ■ ■ □			50% to 75%
■ ■ □ □			25% to 50%
■ □ □ □			0% to 25%
◐ □ □ □			Charge the battery.
■ ■ □ □			The battery may have malfunctioned.
□ □ ■ ■	↑ ↓		

**NOTE:** Depending on the conditions of use and the ambient temperature, the indication may differ slightly from the actual capacity.

## Switch action

**CAUTION:** Before installing the battery cartridge into the tool, always check to see that the switch trigger actuates properly and returns to the "OFF" position when released.

**CAUTION:** When not operating the tool, depress the lock-off button from A side to lock the switch trigger in the OFF position.

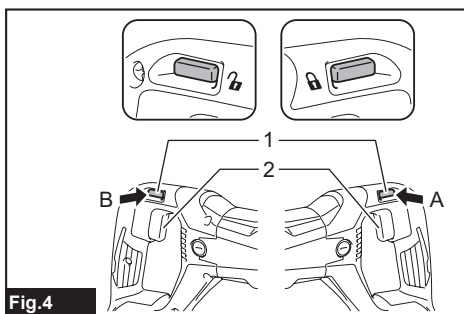

Fig.4

► 1. Lock-off button 2. Switch trigger

To prevent the switch trigger from accidentally pulled, the lock-off button is provided.

To start the tool, depress the lock-off button from B side and pull the switch trigger.



Tool speed is increased by increasing pressure on the switch trigger. Release the switch trigger to stop. After use, always press in the lock-off button from A side.

## ASSEMBLY

**CAUTION:** Always be sure that the tool is switched off and the battery cartridge is removed before carrying out any work on the tool.

### Installing or removing the reciprocating saw blade

**CAUTION:** Always clean out all chips or foreign matter adhering to the blade and around the blade clamp. Failure to do so may cause insufficient tightening of the blade, resulting in a serious injury.

To install the reciprocating saw blade, always make sure that the blade clamp lever (part of the blade clamp sleeve) is in released position  on the insulation cover before inserting the reciprocating saw blade. If the blade clamp lever is in fixed position, rotate the blade clamp lever in the direction of the arrow so that it can be locked at the released position .

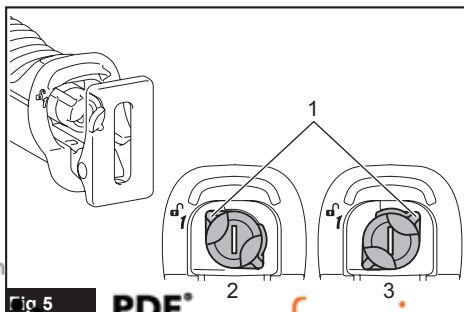

Fig.5

► 1. Blade clamp lever 2. Released position 3. Fixed position

Created with



nitropdf

professional

download the free trial online at [nitropdf.com/professional](http://nitropdf.com/professional)

Insert the reciprocating saw blade into the blade clamp as far as it will go. The blade clamp sleeve rotates and fixes the reciprocating saw blade. Make sure that the reciprocating saw blade cannot be extracted even though you try to pull it out.

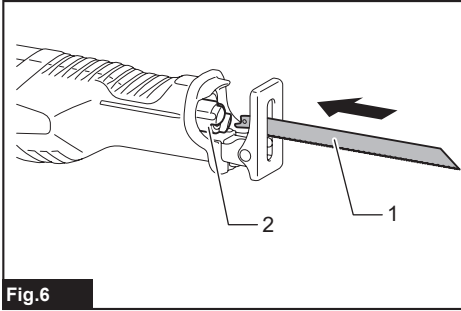

**Fig.6**  
▶ 1. Reciprocating saw blade 2. Blade clamp sleeve

**CAUTION:** If you do not insert the reciprocating saw blade deep enough, the reciprocating saw blade may be ejected unexpectedly during operation. This can be extremely dangerous.

To remove the reciprocating saw blade, rotate the blade clamp lever in the direction of the arrow fully. The reciprocating saw blade is removed and the blade clamp lever is fixed at the released position.

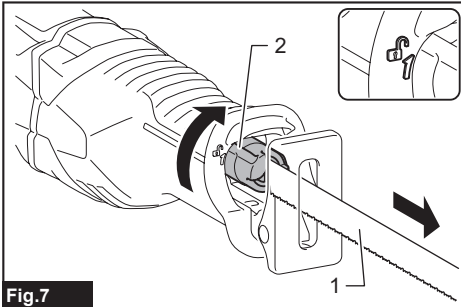

**Fig.7**  
▶ 1. Reciprocating saw blade 2. Blade clamp lever

**CAUTION:** Keep hands and fingers away from the lever during the switching operation. Failure to do so may cause personal injuries.

**NOTE:** If you remove the reciprocating saw blade without rotating the blade clamp lever fully, the lever may not be locked in the released position. In this case, rotate the blade clamp lever fully again, then make sure that the blade clamp lever is locked at the released position.

**NOTE:** If the blade clamp lever is positioned inside the tool, switch on the tool just a second to let the blade out as shown in the figure. Remove the battery cartridge from the tool before installing or removing the reciprocating saw blade.

## OPERATION

**CAUTION:** Always press the shoe firmly against the workpiece during operation. If the shoe is removed or held away from the workpiece during operation, strong vibration and/or twisting will be produced, causing the blade to snap dangerously.

**CAUTION:** Always wear gloves to protect your hands from hot flying chips when cutting metal.

**CAUTION:** Be sure to always wear suitable eye protection which conforms with current national standards.

**CAUTION:** Always use a suitable coolant (cutting oil) when cutting metal. Failure to do so will cause premature blade wear.

Press the shoe firmly against the workpiece. Do not allow the tool to bounce. Bring the reciprocating saw blade into light contact with the workpiece. First, make a pilot groove using a slower speed. Then use a faster speed to continue cutting.

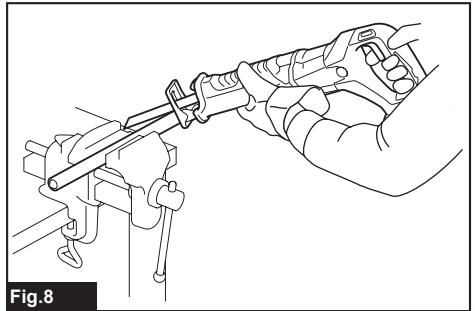

**Fig.8**

## MAINTENANCE

**CAUTION:** Always be sure that the tool is switched off and the battery cartridge is removed before attempting to perform inspection or maintenance.

**NOTICE:** Never use gasoline, benzene, thinner, alcohol or the like. Discoloration, deformation or cracks may result.



## Replacing carbon brushes

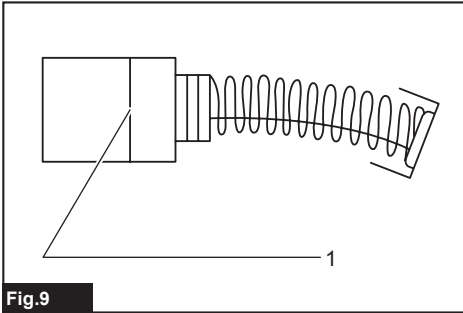

Fig.9

► 1. Limit mark

Check the carbon brushes regularly. Replace them when they wear down to the limit mark. Keep the carbon brushes clean and free to slip in the holders. Both carbon brushes should be replaced at the same time. Use only identical carbon brushes.

1. Use a screwdriver to remove the brush holder caps.
2. Take out the worn carbon brushes, insert the new ones and secure the brush holder caps.

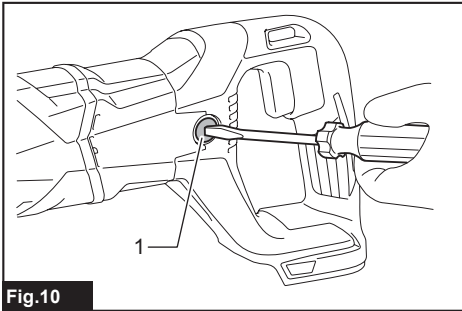

Fig.10

► 1. Brush holder cap

To maintain product SAFETY and RELIABILITY, repairs, any other maintenance or adjustment should be performed by Makita Authorized or Factory Service Centers, always using Makita replacement parts.

## OPTIONAL ACCESSORIES

**CAUTION:** These accessories or attachments are recommended for use with your Makita tool specified in this manual. The use of any other accessories or attachments might present a risk of injury to persons. Only use accessory or attachment for its stated purpose.

If you need any assistance for more details regarding these accessories, ask your local Makita Service Center.

- Recipro saw blades
- Makita genuine battery and charger

**NOTE:** Some items in the list may be included in the tool package as standard accessories. They may differ from country to country.

Makita Jan-Baptist Vinkstraat 2, 3070, Belgium

Makita Corporation Anjo, Aichi, Japan



Created with  
**nitroPDF**  
www.makita.com

professional

865451 A226  
EN  
20151216

download the free trial online at [nitropdf.com/professional](http://nitropdf.com/professional)



INSTRUCTION MANUAL



# Cordless Circular Saw

DSS610

DSS611

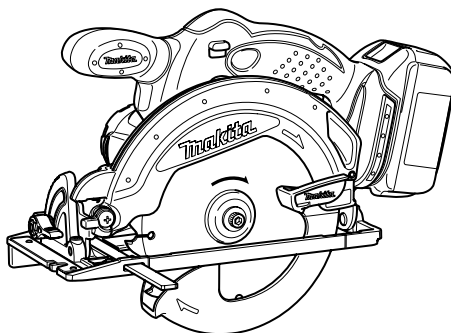

006699

**IMPORTANT:** Read Before Using.

## ENGLISH (Original instructions)

# SPECIFICATIONS

Model		DSS610	DSS611
Blade diameter		165 mm	
Max. Cutting depth	at 90°	57 mm	
	at 45°	40 mm	
	at 50°	36 mm	
No load speed (min <sup>-1</sup> )		3,700	
Overall length		347 mm	
Net weight		3.5 kg	3.3 kg
Rated voltage		D.C. 18 V	

- Due to our continuing program of research and development, the specifications herein are subject to change without notice.
- Specifications and battery cartridge may differ from country to country.
- Weight, with battery cartridge, according to EPTA-Procedure 01/2003

END004-5

ENG900-1

## Symbols

The following show the symbols used for the equipment. Be sure that you understand their meaning before use.



- Read instruction manual.



- Only for EU countries

Do not dispose of electric equipment or battery pack together with household waste material!

In observance of European Directive 2012/19/EU on waste electric and electronic equipment, 2006/66/EC on batteries and accumulators and waste batteries and accumulators and their implementation in accordance with national laws, electric equipment and battery pack that have reached the end of their life must be collected separately and returned to an environmentally compatible recycling facility.

ENE028-1

## Intended use

The tool is intended for performing lengthways and crossways straight cuts and mitre cuts with angles in wood while in firm contact with the workpiece.

ENG905-1

## Noise

The typical A-weighted noise level determined according to EN60745:

Sound pressure level ( $L_{pA}$ ) : 78 dB (A)

Uncertainty (K) : 3 dB (A)

The noise level under working may exceed 80 dB (A).

### Wear ear protection

## Vibration

The vibration total value (tri-axial vector sum) determined according to EN60745:

Work mode : cutting wood

Vibration emission ( $a_{h,W}$ ) : 2.5 m/s<sup>2</sup> or less

Uncertainty (K) : 1.5 m/s<sup>2</sup>

ENG901-1

- The declared vibration emission value has been measured in accordance with the standard test method and may be used for comparing one tool with another.
- The declared vibration emission value may also be used in a preliminary assessment of exposure.

## ⚠WARNING:

- The vibration emission during actual use of the power tool can differ from the declared emission value depending on the ways in which the tool is used.
- Be sure to identify safety measures to protect the operator that are based on an estimation of exposure in the actual conditions of use (taking account of all parts of the operating cycle such as the times when the tool is switched off and when it is running idle in addition to the trigger time).

ENH101-17

## For European countries only

### EC Declaration of Conformity

**Makita declares that the following Machine(s):**

Designation of Machine:

Cordless Circular Saw

Model No./ Type: DSS610, DSS611

**Conforms to the following European Directives:**

2006/42/EC

They are manufactured in accordance with the following standard or standardized documents:

EN60745

The technical file in accordance with 2006/42/EC is available from:

Makita, Jan-Baptist Vinkstraat 2, 3070, Belgium

31.12.2013



000331

Yasushi Fukaya  
Director

Makita, Jan-Baptist Vinkstraat 2, 3070, Belgium

GEA006-2

## General Power Tool Safety

### Warnings

**⚠ WARNING** Read all safety warnings and all instructions. Failure to follow the warnings and instructions may result in electric shock, fire and/or serious injury.

### Save all warnings and instructions for future reference.

The term "power tool" in the warnings refers to your mains-operated (corded) power tool or battery-operated (cordless) power tool.

#### Work area safety

1. **Keep work area clean and well lit.** Cluttered or dark areas invite accidents.
2. **Do not operate power tools in explosive atmospheres, such as in the presence of flammable liquids, gases or dust.** Power tools create sparks which may ignite the dust or fumes.
3. **Keep children and bystanders away while operating a power tool.** Distractions can cause you to lose control.

#### Electrical safety

4. **Power tool plugs must match the outlet. Never modify the plug in any way. Do not use any adapter plugs with earthed (grounded) power tools.** Unmodified plugs and matching outlets will reduce risk of electric shock.
5. **Avoid body contact with earthed or grounded surfaces such as pipes, radiators, ranges and refrigerators.** There is an increased risk of electric shock if your body is earthed or grounded.
6. **Do not expose power tools to rain or wet conditions.** Water entering a power tool will increase the risk of electric shock.
7. **Do not abuse the cord. Never use the cord for carrying, pulling or unplugging the power tool. Keep cord away from heat, oil, sharp edges or moving parts.** Damaged or entangled cords increase the risk of electric shock.

8. **When operating a power tool outdoors, use an extension cord suitable for outdoor use.** Use of a cord suitable for outdoor use reduces the risk of electric shock.
9. **If operating a power tool in a damp location is unavoidable, use a ground fault circuit interrupter (GFCI) protected supply.** Use of an GFCI reduces the risk of electric shock.

#### Personal safety

10. **Stay alert, watch what you are doing and use common sense when operating a power tool. Do not use a power tool while you are tired or under the influence of drugs, alcohol or medication.** A moment of inattention while operating power tools may result in serious personal injury.
11. **Use personal protective equipment. Always wear eye protection.** Protective equipment such as dust mask, non-skid safety shoes, hard hat, or hearing protection used for appropriate conditions will reduce personal injuries.
12. **Prevent unintentional starting. Ensure the switch is in the off-position before connecting to power source and/or battery pack, picking up or carrying the tool.** Carrying power tools with your finger on the switch or energising power tools that have the switch on invites accidents.
13. **Remove any adjusting key or wrench before turning the power tool on.** A wrench or a key left attached to a rotating part of the power tool may result in personal injury.
14. **Do not overreach. Keep proper footing and balance at all times.** This enables better control of the power tool in unexpected situations.
15. **Dress properly. Do not wear loose clothing or jewellery. Keep your hair, clothing, and gloves away from moving parts.** Loose clothes, jewellery or long hair can be caught in moving parts.
16. **If devices are provided for the connection of dust extraction and collection facilities, ensure these are connected and properly used.** Use of dust collection can reduce dust-related hazards.

#### Power tool use and care

17. **Do not force the power tool. Use the correct power tool for your application.** The correct power tool will do the job better and safer at the rate for which it was designed.
18. **Do not use the power tool if the switch does not turn it on and off.** Any power tool that cannot be controlled with the switch is dangerous and must be repaired.
19. **Disconnect the plug from the power source and/or the battery pack from the power tool before making any adjustments, changing accessories, or storing power tools.** Such preventive safety measures reduce the risk of starting the power tool accidentally.

20. **Store idle power tools out of the reach of children and do not allow persons unfamiliar with the power tool or these instructions to operate the power tool.** Power tools are dangerous in the hands of untrained users.
21. **Maintain power tools. Check for misalignment or binding of moving parts, breakage of parts and any other condition that may affect the power tool's operation. If damaged, have the power tool repaired before use.** Many accidents are caused by poorly maintained power tools.
22. **Keep cutting tools sharp and clean.** Properly maintained cutting tools with sharp cutting edges are less likely to bind and are easier to control.
23. **Use the power tool, accessories and tool bits etc. in accordance with these instructions, taking into account the working conditions and the work to be performed.** Use of the power tool for operations different from those intended could result in a hazardous situation.

#### Battery tool use and care

24. **Recharge only with the charger specified by the manufacturer.** A charger that is suitable for one type of battery pack may create a risk of fire when used with another battery pack.
25. **Use power tools only with specifically designated battery packs.** Use of any other battery packs may create a risk of injury and fire.
26. **When battery pack is not in use, keep it away from other metal objects, like paper clips, coins, keys, nails, screws or other small metal objects, that can make a connection from one terminal to another.** Shorting the battery terminals together may cause burns or a fire.
27. **Under abusive conditions, liquid may be ejected from the battery; avoid contact. If contact accidentally occurs, flush with water. If liquid contacts eyes, additionally seek medical help.** Liquid ejected from the battery may cause irritation or burns.

#### Service

28. **Have your power tool serviced by a qualified repair person using only identical replacement parts.** This will ensure that the safety of the power tool is maintained.
29. **Follow instruction for lubricating and changing accessories.**
30. **Keep handles dry, clean and free from oil and grease.**

## CORDLESS CIRCULAR SAW SAFETY WARNINGS

### Cutting procedures

1. **⚠ DANGER: Keep hands away from cutting area and the blade. Keep your second hand on auxiliary handle, or motor housing.** If both hands are holding the saw, they cannot be cut by the blade.
2. **Do not reach underneath the workpiece.** The guard cannot protect you from the blade below the workpiece.
3. **Adjust the cutting depth to the thickness of the workpiece.** Less than a full tooth of the blade teeth should be visible below the workpiece.
4. **Never hold piece being cut in your hands or across your leg. Secure the workpiece to a stable platform.** It is important to support the work properly to minimize body exposure, blade binding, or loss of control.

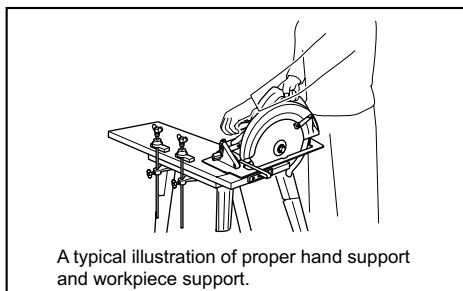

A typical illustration of proper hand support and workpiece support.

000161

5. **Hold the power tool by insulated gripping surfaces only, when performing an operation where the cutting tool may contact hidden wiring.** Contact with a "live" wire will also make exposed metal parts of the power tool "live" and could give the operator an electric shock.
6. **When ripping, always use a rip fence or straight edge guide.** This improves the accuracy of cut and reduces the chance of blade binding.
7. **Always use blades with correct size and shape (diamond versus round) of arbour holes.** Blades that do not match the mounting hardware of the saw will run eccentrically, causing loss of control.
8. **Never use damaged or incorrect blade washers or bolt.** The blade washers and bolt were specially designed for your saw, for optimum performance and safety of operation.

### Kickback causes and related warnings

- kickback is a sudden reaction to a pinched, bound or misaligned saw blade, causing an uncontrolled saw to lift up and out of the workpiece toward the operator;
- when the blade is pinched or bound tightly by the kerf closing down, the blade stalls and the motor reaction drives the unit rapidly back toward the operator;
- if the blade becomes twisted or misaligned in the cut, the teeth at the back edge of the blade can dig into the top surface of the wood causing the blade to climb out of the kerf and jump back toward the operator.

Kickback is the result of saw misuse and/or incorrect operating procedures or conditions and can be avoided by taking proper precautions as given below.

9. **Maintain a firm grip with both hands on the saw and position your arms to resist kickback forces. Position your body to either side of the blade, but not in line with the blade.** Kickback could cause the saw to jump backwards, but kickback forces can be controlled by the operator, if proper precautions are taken.
10. **When blade is binding, or when interrupting a cut for any reason, release the trigger and hold the saw motionless in the material until the blade comes to a complete stop. Never attempt to remove the saw from the work or pull the saw backward while the blade is in motion or kickback may occur.** Investigate and take corrective actions to eliminate the cause of blade binding.
11. **When restarting a saw in the workpiece, centre the saw blade in the kerf and check that saw teeth are not engaged into the material.** If saw blade is binding, it may walk up or kickback from the workpiece as the saw is restarted.
12. **Support large panels to minimise the risk of blade pinching and kickback.** Large panels tend to sag under their own weight. Supports must be placed under the panel on both sides, near the line of cut and near the edge of the panel.

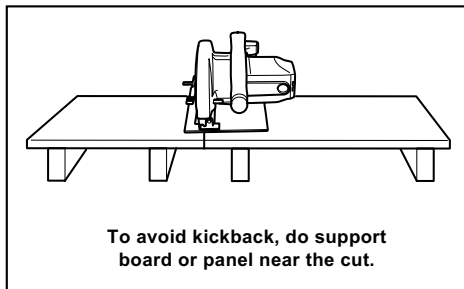

000192

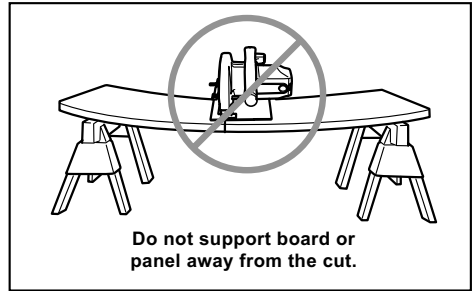

000191

13. **Do not use dull or damaged blades.** Unsharpened or improperly set blades produce narrow kerf causing excessive friction, blade binding and kickback.
14. **Blade depth and bevel adjusting locking levers must be tight and secure before making cut.** If blade adjustment shifts while cutting, it may cause binding and kickback.
15. **Use extra caution when sawing into existing walls or other blind areas.** The protruding blade may cut objects that can cause kickback.
16. **ALWAYS hold the tool firmly with both hands. NEVER place your hand or fingers behind the saw.** If kickback occurs, the saw could easily jump backwards over your hand, leading to serious personal injury.

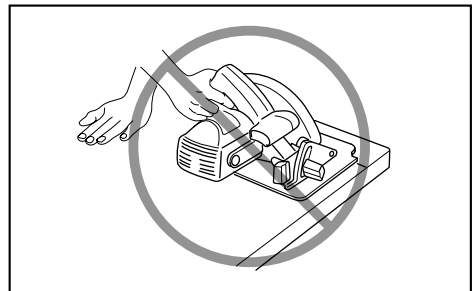

000160

17. **Never force the saw. Push the saw forward at a speed so that the blade cuts without slowing.** Forcing the saw can cause uneven cuts, loss of accuracy, and possible kickback.

### Lower guard function

18. **Check lower guard for proper closing before each use. Do not operate the saw if lower guard does not move freely and close instantly. Never clamp or tie the lower guard into the open position.** If saw is accidentally dropped, lower guard may be bent. Raise the lower guard with the retracting handle and make sure it moves freely and does not touch the blade or any other part, in all angles and depths of cut.

19. Check the operation of the lower guard spring. If the guard and the spring are not operating properly, they must be serviced before use. Lower guard may operate sluggishly due to damaged parts, gummy deposits, or a build-up of debris.
20. Lower guard may be retracted manually only for special cuts such as "plunge cuts" and "compound cuts". Raise lower guard by retracting handle and as soon as blade enters the material, the lower guard must be released. For all other sawing, the lower guard should operate automatically.
21. Always observe that the lower guard is covering the blade before placing saw down on bench or floor. An unprotected, coasting blade will cause the saw to walk backwards, cutting whatever is in its path. Be aware of the time it takes for the blade to stop after switch is released.
22. To check lower guard, open lower guard by hand, then release and watch guard closure. Also check to see that retracting handle does not touch tool housing. Leaving blade exposed is VERY DANGEROUS and can lead to serious personal injury.

**Additional safety warnings**

23. Use extra caution when cutting damp wood, pressure treated lumber, or wood containing knots. Maintain smooth advancement of tool without decrease in blade speed to avoid overheating the blade tips.
24. Do not attempt to remove cut material when blade is moving. Wait until blade stops before grasping cut material. Blades coast after turn off.
25. Avoid cutting nails. Inspect for and remove all nails from lumber before cutting.
26. Place the wider portion of the saw base on that part of the workpiece which is solidly supported, not on the section that will fall off when the cut is made. As examples, Fig. 1 illustrates the RIGHT way to cut off the end of a board, and Fig. 2 illustrates the WRONG way. If the workpiece is short or small, clamp it down. DO NOT TRY TO HOLD SHORT PIECES BY HAND!

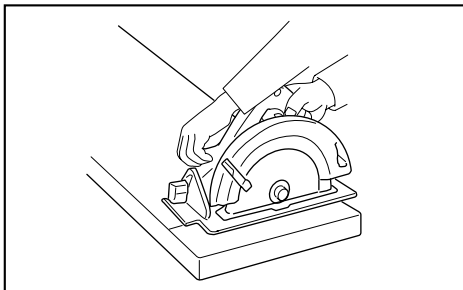

000163

Fig. 2

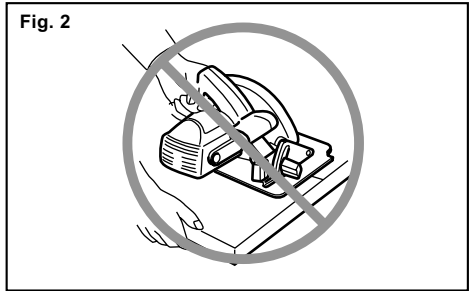

000190

27. Before setting the tool down after completing a cut, be sure that the lower guard has closed and the blade has come to a complete stop.
28. Never attempt to saw with the circular saw held upside down in a vise. This is extremely dangerous and can lead to serious accidents.

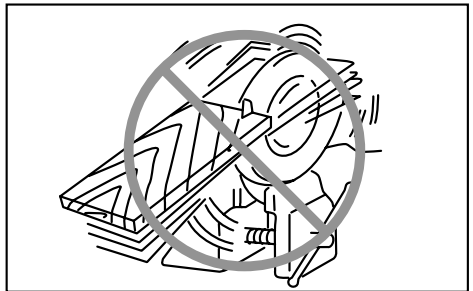

000029

29. Some material contains chemicals which may be toxic. Take caution to prevent dust inhalation and skin contact. Follow material supplier safety data.
30. Do not stop the blades by lateral pressure on the saw blade.
31. Always use blades recommended in this manual. Do not use any abrasive wheels.
32. Keep blade sharp and clean. Gum and wood pitch hardened on blades slows saw and increases potential for kickback. Keep blade clean by first removing it from tool, then cleaning it with gum and pitch remover, hot water or kerosene. Never use gasoline.
33. Wear a dust mask and hearing protection when use the tool.

**SAVE THESE INSTRUCTIONS.**

**⚠WARNING:**

DO NOT let comfort or familiarity with product (gained from repeated use) replace strict adherence to safety rules for the subject product. MISUSE or failure to follow

the safety rules stated in this instruction manual may cause serious personal injury.

ENC007-7

## IMPORTANT SAFETY INSTRUCTIONS

### FOR BATTERY CARTRIDGE

1. Before using battery cartridge, read all instructions and cautionary markings on (1) battery charger, (2) battery, and (3) product using battery.
2. Do not disassemble battery cartridge.
3. If operating time has become excessively shorter, stop operating immediately. It may result in a risk of overheating, possible burns and even an explosion.
4. If electrolyte gets into your eyes, rinse them out with clear water and seek medical attention right away. It may result in loss of your eyesight.
5. Do not short the battery cartridge:
  - (1) Do not touch the terminals with any conductive material.
  - (2) Avoid storing battery cartridge in a container with other metal objects such as nails, coins, etc.
  - (3) Do not expose battery cartridge to water or rain.

A battery short can cause a large current flow, overheating, possible burns and even a breakdown.
6. Do not store the tool and battery cartridge in locations where the temperature may reach or exceed 50 ° C (122 ° F).
7. Do not incinerate the battery cartridge even if it is severely damaged or is completely worn out. The battery cartridge can explode in a fire.
8. Be careful not to drop or strike battery.
9. Do not use a damaged battery.

### SAVE THESE INSTRUCTIONS.

#### Tips for maintaining maximum battery life

1. Charge the battery cartridge before completely discharged.  
Always stop tool operation and charge the battery cartridge when you notice less tool power.
2. Never recharge a fully charged battery cartridge.  
Overcharging shortens the battery service life.
3. Charge the battery cartridge with room temperature at 10 ° C - 40 ° C (50 ° F - 104 ° F). Let a hot battery cartridge cool down before charging it.
4. Charge the battery cartridge once in every six months if you do not use it for a long period of time.

## FUNCTIONAL DESCRIPTION

### ⚠CAUTION:

- Always be sure that the tool is switched off and the battery cartridge is removed before adjusting or checking function on the tool.

### Installing or removing battery cartridge

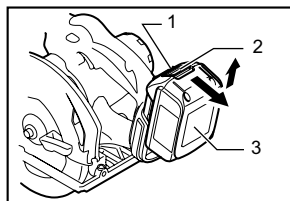

1. Red indicator
2. Button
3. Battery cartridge

012142

### ⚠CAUTION:

- Always switch off the tool before installing or removing of the battery cartridge.
- **Hold the tool and the battery cartridge firmly when installing or removing battery cartridge.** Failure to hold the tool and the battery cartridge firmly may cause them to slip off your hands and result in damage to the tool and battery cartridge and a personal injury.

To remove the battery cartridge, slide it from the tool while sliding the button on the front of the cartridge.

To install the battery cartridge, align the tongue on the battery cartridge with the groove in the housing and slip it into place. Insert it all the way until it locks in place with a little click. If you can see the red indicator on the upper side of the button, it is not locked completely.

### ⚠CAUTION:

- Always install the battery cartridge fully until the red indicator cannot be seen. If not, it may accidentally fall out of the tool, causing injury to you or someone around you.
- Do not install the battery cartridge forcibly. If the cartridge does not slide in easily, it is not being inserted correctly.

## Battery protection system (Lithium-ion battery with star marking)

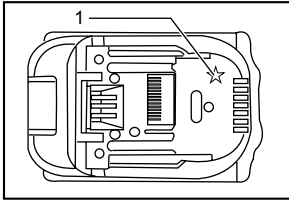

1. Star marking

012128

Lithium-ion batteries with a star marking are equipped with a protection system. This system automatically cuts off power to the tool to extend battery life.

The tool will automatically stop during operation if the tool and/or battery are placed under one of the following conditions:

- **Overloaded:**  
The tool is operated in a manner that causes it to draw an abnormally high current.  
In this situation, release the trigger switch on the tool and stop the application that caused the tool to become overloaded. Then pull the trigger switch again to restart.  
If the tool does not start, the battery is overheated. In this situation, let the battery cool before pulling the trigger switch again.
- **Low battery voltage:**  
The remaining battery capacity is too low and the tool will not operate. In this situation, remove and recharge the battery.

## Adjusting depth of cut

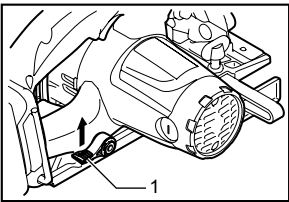

1. Lever

006701

### ⚠ CAUTION:

- After adjusting the depth of cut, always tighten the lever securely.

Loosen the lever on the side of the rear handle and move the base up or down. At the desired depth of cut, secure the base by tightening the lever.

For cleaner, safer cuts, set cut depth so that no more than one blade tooth projects below workpiece. Using proper cut depth helps to reduce potential for dangerous KICKBACKS which can cause personal injury.

## Bevel cutting

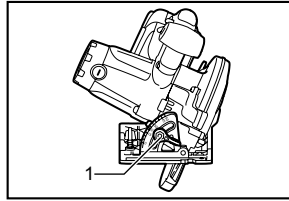

1. Lever

006702

### For Model DSS610

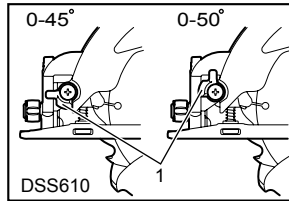

1. Stopper

013952

Loosen the lever on the bevel scale plate on the front base. Set for the desired angle (0° - 50°) by tilting accordingly, then tighten the lever securely. Use the 45° stopper when you do precise 45° angle cutting. Turn the stopper counterclockwise fully for bevel cut (0° - 45°) and turn it clockwise for 0° - 50° bevel cuts.

### For Model DSS611

Loosen the lever on the bevel scale plate on the front base. Set for the desired angle (0° - 50°) by tilting accordingly, then tighten the lever securely.

## Sighting

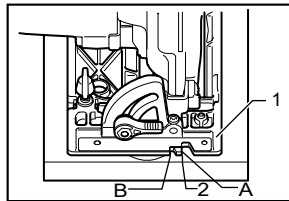

1. Base  
2. Cutting line

006704

For straight cuts, align the A position on the front of the base with your cutting line. For 45° bevel cuts, align the B position with it.



## Switch action

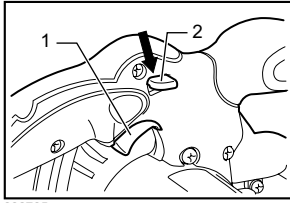

1. Switch trigger
2. Lock-off lever

006705

### ⚠CAUTION:

- Before inserting the battery cartridge into the tool, always check to see that the switch trigger actuates properly and returns to the "OFF" position when released.
- Do not pull the switch trigger hard without pressing the lock-off lever. This can cause switch breakage.

To prevent the switch trigger from being accidentally pulled, a lock-off lever is provided. To start the tool, press the lock-off lever and pull the switch trigger. Release the switch trigger to stop.

### ⚠WARNING:

- For your safety, this tool is equipped with lock-off lever which prevents the tool from unintended starting. NEVER use the tool if it runs when you simply pull the switch trigger without pressing the lock-off lever. Return tool a MAKITA service center for proper repairs BEFORE further usage.
- NEVER tape down or defeat purpose and function of lock-off lever.

## Lighting the lamp For Model DSS610 only

### ⚠CAUTION:

- Do not look in the light or see the source of light directly.

Only to turn on the light, pull the switch trigger without pressing the lock-off lever. To turn on the light and run the tool, press the lock-off lever and pull the switch trigger with the lock-off lever being pressed.

### NOTE:

- Use a dry cloth to wipe the dirt off the lens of lamp. Be careful not to scratch the lens of lamp, or it may lower the illumination.
- Do not use gasoline, thinner or the like to clean the lens of lamp. Using such substances will damage the lens.

## ASSEMBLY

### ⚠CAUTION:

- Always be sure that the tool is switched off and the battery cartridge is removed before carrying out any work on the tool.

### Removing or installing saw blade

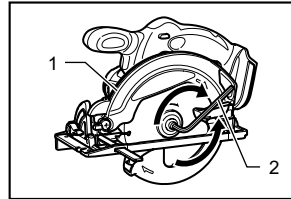

1. Shaft lock
2. Hex wrench

006706

### ⚠CAUTION:

- Be sure the blade is installed with teeth pointing up at the front of the tool.
- Use only the Makita wrench to install or remove the blade.

To remove the blade, press the shaft lock so that the blade cannot revolve and use the wrench to loosen the hex bolt clockwise. Then remove the hex bolt, outer flange and blade. To install the blade, follow the removal procedure in reverse. BE SURE TO TIGHTEN THE HEX BOLT COUNTERCLOCKWISE SECURELY.

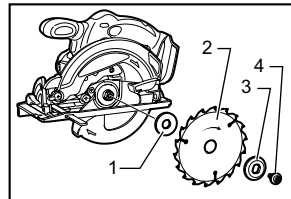

1. Inner flange
2. Saw blade
3. Outer flange
4. Hex bolt

006707

When changing blade, make sure to also clean upper and lower blade guards of accumulated sawdust. Such efforts do not, however, replace the need to check lower guard operation before each use.

### Only for tools with a ring (specific country)

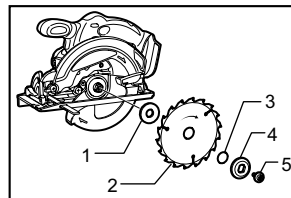

1. Inner flange
2. Saw blade
3. Ring
4. Outer flange
5. Hex bolt

013488

**⚠WARNING:**

- Before mounting the blade onto the spindle, always be sure that the correct ring for the blade's arbor hole you intend to use is installed between the inner and the outer flanges. Use of the incorrect arbor hole ring may result in the improper mounting of the blade causing blade movement and severe vibration resulting in possible loss of control during operation and in serious personal injury.

### Hex wrench storage

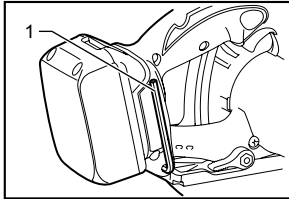

1. Hex wrench

006708

When not in use, store the hex wrench as shown in the figure to keep it from being lost.

### Connecting a vacuum cleaner

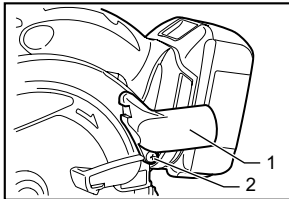

1. Dust nozzle  
2. Screw

006711

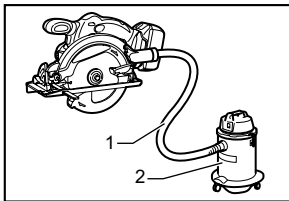

1. Hose  
2. Vacuum cleaner

006712

When you wish to perform clean cutting operation, connect a Makita vacuum cleaner to your tool. Install the dust nozzle on the tool using the screw. Then connect a hose of the vacuum cleaner to the dust nozzle as shown in the figure.

## OPERATION

**⚠CAUTION:**

- Always insert the battery cartridge all the way until it locks in place. If you can see the red part on the upper side of the button, it is not locked completely. Insert it fully until the red part cannot be seen. If not, it may accidentally fall out of the tool, causing injury to you or someone around you.
- Be sure to move the tool forward in a straight line gently. Forcing or twisting the tool will result in overheating the motor and dangerous kickback, possibly causing severe injury.
- If the tool is operated continuously until the battery cartridge has discharged, allow the tool to rest for 15 minutes before proceeding with a fresh battery.

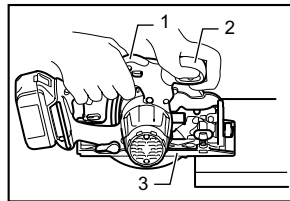

1. Rear handle  
2. Front grip  
3. Base

006709

Hold the tool firmly. The tool is provided with both a front grip and rear handle. Use both to best grasp the tool. If both hands are holding saw, they cannot be cut by the blade. Set the base on the workpiece to be cut without the blade making any contact. Then turn the tool on and wait until the blade attains full speed. Now simply move the tool forward over the workpiece surface, keeping it flat and advancing smoothly until the sawing is completed.

To get clean cuts, keep your sawing line straight and your speed of advance uniform. If the cut fails to properly follow your intended cut line, do not attempt to turn or force the tool back to the cut line. Doing so may bind the blade and lead to dangerous kickback and possible serious injury. Release switch, wait for blade to stop and then withdraw tool. Realign tool on new cut line, and start cut again. Attempt to avoid positioning which exposes operator to chips and wood dust being ejected from saw. Use eye protection to help avoid injury.

### Rip fence (Guide rule)

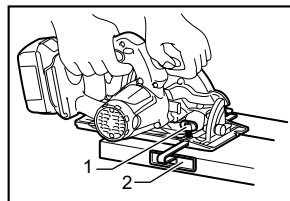

1. Clamping screw  
2. Rip fence (Guide rule)

006710

The handy rip fence allows you to do extra-accurate straight cuts. Simply slide the rip fence up snugly against the side of the workpiece and secure it in position with the screw on the front of the base. It also makes repeated cuts of uniform width possible.

## MAINTENANCE

### ⚠CAUTION:

- Always be sure that the tool is switched off and the battery cartridge is removed before attempting to perform inspection or maintenance.
- Never use gasoline, benzine, thinner, alcohol or the like. Discoloration, deformation or cracks may result.

### Adjusting for accuracy of 90° and 45° cut (vertical and 45° cut)

#### For Model DSS610

This adjustment has been made at the factory. But if it is off, adjust the adjusting screws with a hex wrench while inspecting 90° or 45° the blade with the base using a triangular rule or square rule, etc.

### Adjusting for accuracy of 90° cut (vertical cut)

#### For Model DSS611

This adjustment has been made at the factory. But if it is off, adjust the adjusting screws with a hex wrench while inspecting 90° the blade with the base using a triangular rule or square rule, etc.

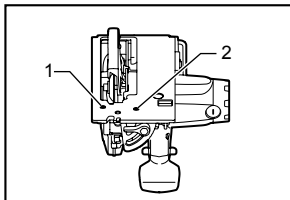

013953

1. Adjusting screw for 45° (DSS610 only)
2. Adjusting screw for 90°

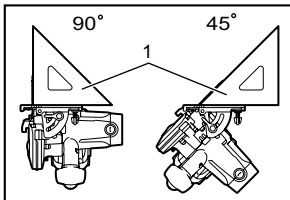

006714

1. Triangular rule

## Replacing carbon brushes

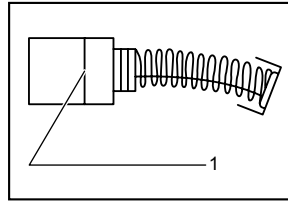

001145

1. Limit mark

Remove and check the carbon brushes regularly. Replace when they wear down to the limit mark. Keep the carbon brushes clean and free to slip in the holders. Both carbon brushes should be replaced at the same time. Use only identical carbon brushes.

Use a screwdriver to remove the brush holder caps. Take out the worn carbon brushes, insert the new ones and secure the brush holder caps.

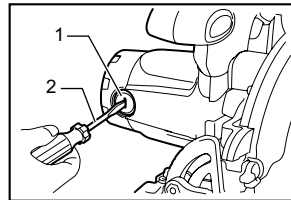

006715

1. Brush holder cap
2. Screwdriver

To maintain product SAFETY and RELIABILITY, repairs, any other maintenance or adjustment should be performed by Makita Authorized Service Centers, always using Makita replacement parts.

## OPTIONAL ACCESSORIES

### ⚠CAUTION:

- These accessories or attachments are recommended for use with your Makita tool specified in this manual. The use of any other accessories or attachments might present a risk of injury to persons. Only use accessory or attachment for its stated purpose.

If you need any assistance for more details regarding these accessories, ask your local Makita Service Center.

- Saw blades
- Rip fence (Guide rule)
- Hex wrench 5
- Dust nozzle
- Makita genuine battery and charger

### NOTE:

- Some items in the list may be included in the tool package as standard accessories. They may differ from country to country.

**Makita** Jan-Baptist Vinkstraat 2, 3070, Belgium  
**Makita Corporation** Anjo, Aichi, Japan















<b>GB</b>	<b>Two Port Multi Fast Charger</b> .....	2	<b>S</b>	<b>Multi-snabbladdare med dubbla portar</b> .....	24
<b>F</b>	<b>Chargeur Rapide 2 Batteries</b> .....	4	<b>N</b>	<b>Multi-hurtiglader med to porter</b> .....	27
<b>D</b>	<b>Schnellladegerät</b> .....	6	<b>FIN</b>	<b>Kaksipaikkainen nopea monilaturi</b> .....	29
<b>I</b>	<b>Multicaricatore veloce a due porte</b> .....	9		Vairāku ierīču ātras darbības lādētājs ar divām pieslēgvietām .....	31
<b>NL</b>	<b>Accu-snellader met dubbel accustation</b> .....	11	<b>LV</b>		
<b>E</b>	<b>Multi-Cargador Rápido de Dos Puertos</b> .....	13	<b>LT</b>	<b>Dvieju prievadų daugialypis spartusis įkroviklis</b> .....	33
<b>P</b>	<b>Carregador Rápido de 2 Postos</b> .....	16	<b>EE</b>	<b>Kahe pesaga kiire multilaadija</b> .....	35
<b>DK</b>	<b>Multi-hurtigoplader med to porte</b> .....	18	<b>RUS</b>	<b>Быстрозарядное Устройство На Два Аккумулятора</b> .....	37
<b>GR</b>	<b>Ταχύς φορτιστής πολλαπλών χρήσεων δύο θυρών</b> .....	20	<b>CS</b>	<b>双端口充电器</b> .....	40
<b>TR</b>	<b>İki Yuvalı Hızlı Şarj Aleti</b> .....	22	<b>PR</b>	<b>نارژر چندتایی دو جایگاهی سریع</b> .....	44
			<b>AR</b>	<b>شاحن سريع متعدد ذو منفذين</b> .....	47



**WARNING:** THIS APPLIANCE CAN BE USED BY CHILDREN AGED FROM 8 YEARS AND ABOVE AND PERSONS WITH REDUCED PHYSICAL, SENSORY OR MENTAL CAPABILITIES OR LACK OF EXPERIENCE AND KNOWLEDGE IF THEY HAVE BEEN GIVEN SUPERVISION OR INSTRUCTION CONCERNING USE OF THE APPLIANCE IN A SAFE WAY AND UNDERSTAND THE HAZARDS INVOLVED. CHILDREN SHALL NOT PLAY WITH THE APPLIANCE. CLEANING AND USER MAINTENANCE SHALL NOT BE MADE BY CHILDREN WITHOUT SUPERVISION.

**Symbols**

The followings show the symbols used for the equipment. Be sure that you understand their meaning before use.

- |  |  |   |                                   |
|--|--|---|-----------------------------------|
|  | • Indoor use only                                    |  | • Read instruction manual.        |
|  | • DOUBLE INSULATION                                  |  | • Ready to charge                 |
|  | • Charging   |  | • Charging complete               |
|  | • Delay charge (Battery cooling or too cold battery) |  | • Defective battery               |
|  | • Conditioning                                       |  | • Cooling abnormality             |
|  | • Do not short batteries.                            |  | • Do not destroy battery by fire. |
|  | • Do not expose battery to water or rain.            |  | • Always recycle batteries.       |
|  | • Only for EU countries                              |   |                                   |
- Do not dispose of electric equipment or battery pack together with household waste material!  
In observance of the European Directives, on Waste Electric and Electronic Equipment and Batteries and Accumulators and Waste Batteries and Accumulators and their implementation in accordance with national laws, electric equipment and batteries and battery pack(s) that have reached the end of their life must be collected separately and returned to an environmentally compatible recycling facility.

- SAVE THESE INSTRUCTIONS – This manual contains important safety and operating instructions for battery charger.
- Before using battery charger, read all instructions and cautionary markings on (1) battery charger, (2) battery, and (3) product using battery.
- CAUTION – To reduce risk of injury, charge only Makita type rechargeable batteries. Other types of batteries may burst causing personal injury and damage.
- Non-rechargeable batteries cannot be charged with this battery charger.
- Use a power source with the voltage specified on the nameplate of the charger.
- Do not charge the battery cartridge in presence of flammable liquids or gases.
- Do not expose charger to rain or snow.
- Never carry charger by cord or yank it to disconnect from receptacle.
- After charging or before attempting any maintenance or cleaning, unplug the charger from the power source. Pull by plug rather than cord whenever disconnecting charger.
- Make sure cord is located so that it will not be stepped on, tripped over, or otherwise subjected to damage or stress.
- Do not operate charger with damaged cord or plug. If the cord or plug is damaged, ask Makita authorized service center to replace it in order to avoid a hazard.
- Do not operate or disassemble charger if it has received a sharp blow, been dropped, or otherwise damaged in any way; take it to a qualified serviceman. Incorrect use or reassembly may result in a risk of electric shock or fire.
- Do not charge battery cartridge when room temperature is BELOW 10°C (50°F) or ABOVE 40°C (104°F). At cold temperature, charging may not start.
- Do not attempt to use a step-up transformer, an engine generator or DC power receptacle.
- Do not allow anything to cover or clog the charger vents.
- Do not insert a nail, wire, etc. into USB power supply port.

**Charging for MAKITA batteries**

This charger can charge two batteries at the same time.

- Plug the charger into the proper AC voltage source. Charging light will flash in green color repeatedly.
- Insert the battery cartridge into charger until it stops adjusting to the guide of charger. Terminal cover of charger can be opened with inserting and closed with pulling out the battery cartridge.
- When the battery cartridge is inserted, the red charging light will light up and charging will begin with a preset brief melody sound coming out for assurance as to which sound will come out to notify the completion of charging.
- With finish of charge, the charging light will change from red one to green one and the melody sound or buzzer sound (a long beep) comes out to notify completion of charge.
- Charging time varies by temperature (10°C (50°F) – 40°C (104°F)) that battery cartridge is charged at and conditions of the battery cartridge, such as a battery cartridge which is new or has not been used for a long period of time.
- After charging, remove the battery cartridge from charger and unplug the charger.

## Changing melody sound of completed charging

1. Insert the battery cartridge into the charging port that you want to change the melody sound of completed charging. It brings out the last preset brief melody sound of completed charging.
2. Removing and re-inserting it within five seconds after this action makes the melody sound change.
3. Every time removing and re-inserting it within another five seconds after this, the melody sound changes in order.
4. When the desired melody sound comes out, leave the battery cartridge being inserted and the charge will begin. When a "short beep" mode is selected, no completed charging signals comes out. (Silent Mode)
5. With finish of charge, the green light remains lit with the red light going out and the melody sound preset at the insertion of battery cartridge or buzzer sound (a long beep) comes out to notify completion of charge. (In selected silent mode, no sounds come out.)
6. Preset melody sound remains stored even when the charger is unplugged.

Voltage	9.6 V	12 V	14.4 V	Capacity (Ah)	Charging time (Minutes)
Number of cells	8	10	12		
Ni-MH Battery cartridge	BH9020A	—	—	2.0	20
	—	BH1220/C	BH1420	2.0	15
	BH9033A	—	—	3.3	30
	—	BH1233/C	BH1433	3.3	22

Voltage	14.4 V	18 V	14.4 V	18 V	Capacity (Ah) according to IEC61960	Charging time (Minutes)
Number of cells	4	5	8	10		
Li-ion Battery cartridge	BL1415	BL1815	—	—	1.3	15
	—	—	BL1430/A	BL1830	3.0	22
	BL1415N/ BL1415NA	BL1815N	—	—	1.5	15
	—	BL1820/ BL1820B	—	—	2.0	24
	—	—	BL1440	BL1840/ BL1840B	4.0	36
	—	—	BL1450	BL1850/ BL1850B	5.0	45
	—	—	—	BL1860B	6.0	55

### NOTE:

- The battery charger is for charging Makita-battery cartridge. Never use it for other purposes or for other manufacturer's batteries.
- When you charge a battery cartridge which is new or has not been used for a long period of time, it may not accept a full charge until after discharging it completely and recharging a couple of times. (Ni-MH battery only)
- If charging light may flash in red color, battery condition is as below and charging may not start.
  - Battery cartridge from just-operated tool or battery cartridge that has been left in a location exposed to direct sunlight for a long time.
  - Battery cartridge that has been left for a long time in a location exposed to cold air.
- When the battery cartridge is too hot, charging will begin after the cooling fan installed in the charger cools the battery cartridge. Charging will begin after the battery cartridge temperature reaches the degree at which charging is possible.
- If the charging light flashes alternately in green and red color, charging is not possible. The terminals on the charger or battery cartridge are clogged with dust or the battery cartridge is worn out or damaged.

## Cooling system

- This charger is equipped with cooling fan for heated battery in order to enable the battery to prove its own performance. Sound of cooling air comes out during cooling, which means no trouble on the charger.
  - Yellow light will flash for warning in the following cases.
    - Trouble on cooling fan
    - Incomplete cool down of battery, such as, being clogged with dust
- The battery can be charged in spite of the yellow warning light. But the charging time will be longer than usual in this case. Check the sound of cooling fan, vent on the charger and battery, which can be sometime clogged with dust.
- The cooling system is in order although no sound of cooling fan comes out, if the yellow warning light will not flash.
  - Always keep clean the vent on charger and battery for cooling.
  - The products should be sent to repair or maintenance, if the yellow warning light will frequently flash.

## Conditioning charge

Conditioning charge can extend the life of battery by automatically searching the optimum charging condition for the batteries in every situation.

The battery employed in the following conditions repeatedly requires "conditioning charge" to prevent fast wear out. In that case, yellow light lights up.

1. Recharge of battery with its high temperature

2. Recharge of battery with its low temperature
3. Recharge of full charged battery
4. Over-discharge of battery (continue to discharge battery in spite of down of power.)

The charging time of such battery is longer than usual.

## Using with USB device

This charger works as an external power supply for USB device.

1. Open the cover of the USB power supply port. Connect the USB cable to the USB power supply port and USB device.
2. Plug the charger into a power source.
3. After charging, unplug the charger.

### Note:

- Before connecting USB device to the charger, always backup your data of USB device. Otherwise your data may lose by any possibility.
- The charger may not supply power to some USB devices.
- When not using or after charging, remove the USB cable and close the cover.

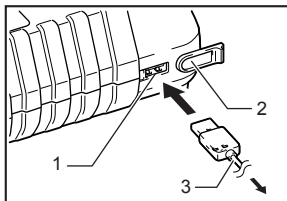

1. USB power supply port
2. Cover
3. USB cable

## FRANÇAIS

**AVERTISSEMENT : CET APPAREIL PEUT ÊTRE UTILISÉ PAR DES ENFANTS DE 8 ANS ET PLUS, AINSI QUE PAR DES PERSONNES PRÉSENTANT DES CAPACITÉS PHYSIQUES, SENSORIELLES OU MENTALES RÉDUITES, OU PAR DES PERSONNES DÉNUÉES D'EXPÉRIENCE ET DE CONNAISSANCES S'ILS ONT PU FAIRE L'OBJET D'UNE SURVEILLANCE OU RECEVOIR DES INSTRUCTIONS PRÉALABLES CONCERNANT L'UTILISATION EN TOUTE SÉCURITÉ DE L'APPAREIL ET S'ILS COMPRENNENT LES RISQUES ASSOCIÉS. NE LAISSEZ PAS LES ENFANTS JOUER AVEC L'APPAREIL. LE NETTOYAGE ET L'ENTRETIEN À LA CHARGE DE L'UTILISATEUR NE DOIVENT PAS ÊTRE RÉALISÉS PAR DES ENFANTS SANS SURVEILLANCE.**

### Symboles

Nous donnons ci-dessous les symboles utilisés pour l'équipement. Assurez-vous que vous en avez bien compris la signification avant d'utiliser l'équipement.



- A utiliser à l'intérieur



- DOUBLE ISOLATION



- En charge



- Charge différée (Batterie en cours de refroidissement ou batterie trop froide)



- Recharge normale



- Ne jamais court-circuiter les bornes d'une batterie.



- Ne pas exposer la batterie à l'eau ou à la pluie.



- Pour les pays européens uniquement

Ne pas jeter les équipements électriques ou les batteries dans les ordures ménagères ! Conformément à la directive européenne relative aux déchets d'équipements électriques et électroniques (DEEE) et à la directive européenne relative aux piles et accumulateurs ainsi qu'aux déchets de piles et accumulateurs et à leur transposition dans la législation nationale, les équipements électriques, les piles et assemblages en batterie qui ont atteint la fin de leur durée de service doivent être collectés à part et être soumis à un recyclage respectueux de l'environnement.



- Lire le mode d'emploi.



- Prêt à recharger



- Recharge terminée



- Batterie défectueuse



- Problème de refroidissement



- Ne pas détruire la batterie par le feu.



- Recycler toujours les batteries.

1. CONSERVEZ CES INSTRUCTIONS – Ce manuel contient d'importantes consignes de sécurité et instructions d'utilisation pour le chargeur de batterie.

2. Avant d'utiliser le chargeur de batterie, veuillez lire toutes les instructions et tous les avertissements inscrits sur (1) le chargeur de batterie, (2) la batterie et (3) le produit alimenté par la batterie.



3. ATTENTION – Pour réduire les risques de blessure, chargez uniquement des batteries rechargeables Makita. Les autres types de batterie peuvent entraîner des blessures et des dommages en éclatant.
4. Il n'est pas possible de charger des batteries non rechargeables avec ce chargeur de batterie.
5. Utilisez une source d'alimentation dont la tension correspond à celle spécifiée sur la plaque signalétique du chargeur.
6. Ne chargez pas la batterie en présence de liquides ou gaz inflammables.
7. N'exposez pas le chargeur à la pluie ou à la neige.
8. Ne transportez jamais le chargeur par son cordon d'alimentation, et ne tirez jamais sur le cordon lui-même pour débrancher sa fiche de la prise de courant.
9. Après la charge ou avant d'effectuer l'entretien ou le nettoyage, débranchez le chargeur de la source d'alimentation. Pour débrancher le chargeur, ne tirez pas sur le cordon lui-même ; saisissez-le plutôt par sa fiche.
10. Vous devez placer le cordon de sorte que personne ne marche ou ne trébuche dessus, et de sorte qu'il ne risque aucun dommage et ne soit pas trop tendu.
11. N'utilisez pas le chargeur avec un cordon ou une fiche endommagé. Si le cordon ou la fiche est endommagé, faites-le remplacer dans un centre de service agréé Makita pour éviter tout danger.
12. Évitez d'utiliser ou de démonter le chargeur s'il a subi un choc violent, s'il a été échappé, ou s'il a été abîmé de quelque manière que ce soit ; apportez-le chez un réparateur agréé. L'utilisation ou le remontage incorrect comporte un risque de choc électrique ou d'incendie.
13. Ne chargez pas la batterie lorsque la température de la pièce est INFÉRIEURE à 10 °C ou SUPÉRIEURE à 40 °C. À basse température, la charge risque de ne pas démarrer.
14. Ne tentez pas d'utiliser un transformateur élévateur, un groupe électrogène ou une prise de courant continu.
15. Ne laissez rien recouvrir ou boucher les ouvertures du chargeur.
16. N'insérez pas de clou, de fil électrique, etc., dans le port d'alimentation USB.

### Chargement des batteries MAKITA

Ce chargeur permet de charger deux batteries simultanément.

1. Branchez le chargeur sur une source de courant alternatif dont la tension est adaptée. Le témoin de charge clignote en vert de manière répétée.
2. Insérer la batterie dans le chargeur jusqu'à ce qu'elle s'arrête, ajustée sur le guide du chargeur. Le couvre-bornes du chargeur peut être ouvert en insérant la batterie, et fermé en la retirant.
3. Lorsque vous insérez la batterie, le témoin de charge rouge s'allume et la charge commence ; une courte mélodie prérégulée est alors émise pour vous indiquer quel sera le son émis pour vous informer de l'achèvement de la charge.
4. Lorsque la charge est terminée, le témoin de charge passe du rouge au vert et une mélodie ou une sonnerie (un long bip) est émise pour vous informer de l'achèvement de la charge.
5. Le temps de charge varie suivant la température environnante (10 °C – 40 °C) à laquelle s'effectue la charge de la batterie, et suivant l'état de la batterie, comme par exemple si elle est neuve ou si elle est restée inutilisée pendant longtemps.
6. Après la charge, retirez la batterie et débranchez le chargeur.

### Modification de la mélodie de fin de charge

1. Insérez la batterie dans le port de charge dont vous souhaitez modifier la mélodie de fin de charge. La dernière mélodie de fin de charge prérégulée retentit.
2. Si vous retirez et réinsérez la batterie dans les cinq secondes qui suivent cette action, la mélodie changera.
3. Chaque fois que vous retirez et réinsérez la batterie dans les cinq secondes par la suite, la mélodie change dans l'ordre préétabli.
4. Lorsque la mélodie désirée est émise, laissez la batterie insérée et la charge commencera. Si vous sélectionnez le mode "court bip", aucun signal de charge terminée ne sera émis. (Mode silencieux)
5. Lorsque la charge est terminée, le témoin de charge vert demeure allumé et le témoin rouge s'éteint, et la mélodie ou la sonnerie (un long bip) prérégulée au moment de l'insertion de la batterie est émise pour vous informer de l'achèvement de la charge. (Si le mode silencieux est sélectionné, aucun son n'est émis.)
6. La mélodie prérégulée demeure en mémoire même lorsque vous débranchez le chargeur.

Tension	9,6 V	12 V	14,4 V	Capacité (Ah)	Temps de charge (en minutes)
Nombre de cellules	8	10	12		
Cartouche de batterie au Ni-MH	BH9020A	—	—	2,0	20
	—	BH1220/C	BH1420	2,0	15
	BH9033A	—	—	3,3	30
	—	BH1233/C	BH1433	3,3	22

Tension	14,4 V	18 V	14,4 V	18 V	Capacité (Ah) selon IEC61960	Temps de charge (en minutes)
Nombre de cellules	4	5	8	10		
Cartouche de batterie au Li-ion	BL1415	BL1815	—	—	1,3	15
	—	—	BL1430/A	BL1830	3,0	22
	BL1415N/ BL1415NA	BL1815N	—	—	1,5	15
	—	BL1820/ BL1820B	—	—	2,0	24
	—	—	BL1440	BL1840/ BL1840B	4,0	36
	—	—	BL1450	BL1850/ BL1850B	5,0	45
	—	—	—	BL1860B	6,0	55

### NOTE :

- Le chargeur de batterie est conçu pour les batteries Makita. Ne jamais l'utiliser à d'autres fins ou avec les batteries d'autres fabricants.
- Lorsque vous chargez une cartouche de batterie neuve ou restée inutilisée pendant une période prolongée, il se peut que vous deviez la recharger et la décharger à quelques reprises avant qu'elle n'accepte une charge complète. (Batterie au Ni-MH seulement)
- Si le témoin de charge clignote en rouge, l'état de la batterie est tel qu'indiqué ci-dessous et il se peut que la charge ne commence pas.

- Cartouche de batterie d'un outil qui vient tout juste d'être utilisée, ou cartouche de batterie qui a été laissée longtemps dans un endroit exposé directement aux rayons du soleil.
- Cartouche de batterie qui a été laissée longtemps dans un endroit exposé à de l'air froid.

Lorsque la batterie est trop chaude, la charge ne commence qu'une fois la batterie refroidie par le ventilateur de refroidissement du chargeur. La charge commencera lorsque la température de la cartouche de batterie aura atteint le degré pour lequel la charge est possible.

- Si le témoin de charge clignote alternativement en vert et en rouge, la charge n'est pas possible. Les bornes du chargeur ou de la batterie sont alors bloquées par la poussière, ou bien la batterie est soit usée, soit endommagée.

### Système de refroidissement

- Ce chargeur est doté d'un ventilateur de refroidissement pour batterie chaude afin de permettre à la batterie de fournir son plein rendement. Un son de refroidissement d'air s'échappe pendant le refroidissement, ce qui signifie que le chargeur fonctionne correctement.
  - Un témoin jaune d'avertissement clignote dans les cas suivants.
    - Problème de ventilateur de refroidissement.
    - Refroidissement insuffisant de la batterie, causé par une accumulation de poussière, etc.
- La batterie peut être chargée même si le témoin jaune d'avertissement est allumé. Mais dans ce cas, le temps de charge sera plus long que d'ordinaire.

Vérifier le son du ventilateur de refroidissement, ainsi que les événements du chargeur et de la batterie, où s'accumule parfois de la poussière.

- Le système de refroidissement fonctionne normalement si le témoin jaune d'avertissement ne clignote pas, et ce même si aucun son ne provient du ventilateur de refroidissement.
- Toujours garder les événements du chargeur et de la batterie propres pour permettre le refroidissement.
- Si le témoin jaune d'avertissement clignote souvent, les produits devraient être envoyés pour réparation ou entretien.

### Charge de remise en condition

La charge de remise en condition peut faire augmenter la durée de vie de la batterie en effectuant automatiquement une recherche du niveau de charge optimale des batteries dans toute situation. Une batterie utilisée à plusieurs reprises dans les conditions suivantes nécessitera une "charge de remise en condition" pour éviter qu'elle ne s'use rapidement. Dans ce cas, le témoin jaune s'allume.

1. Recharge de la batterie alors qu'elle est très chaude
  2. Recharge de la batterie alors qu'elle est très froide
  3. Recharge d'une batterie déjà complètement chargée
  4. Décharge excessive de la batterie (continuer de décharger la batterie malgré l'absence d'alimentation)
- Le temps de charge est alors plus long que d'ordinaire.

### Utilisation avec un dispositif USB

Ce chargeur peut servir de source d'alimentation externe pour dispositif USB.

1. Ouvrez le cache du port d'alimentation USB. Connectez le port d'alimentation USB et le dispositif USB au moyen du câble USB.
2. Branchez le chargeur sur une source d'alimentation.
3. Une fois la charge terminée, débranchez le chargeur.

#### Note :

- Avant de raccorder un dispositif USB au chargeur, sauvegardez toujours les données du dispositif USB. Sinon, vous risquez de perdre vos données.
- Il est possible que le chargeur ne parvienne pas à alimenter certains dispositifs USB.
- Lorsque vous n'utilisez pas le chargeur ou une fois la charge terminée, retirez le câble USB et fermez le cache.

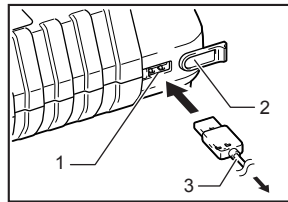

1. Port d'alimentation USB
2. Cache
3. Câble USB

## DEUTSCH

**WARNUNG: DIESES GERÄT KANN VON KINDERN AB 8 JAHREN UND PERSONEN MIT VERMINDERTEN KÖRPERLICHEN, SENSORISCHEN ODER GEISTIGEN FÄHIGKEITEN BZW. MANGEL AN ERFAHRUNG UND KENNTNISSEN BENUTZT WERDEN, VORAUSGESETZT, DASS SIE BEAUFSICHTIGT WERDEN ODER ANWEISUNGEN ZUM SICHEREN GEBRAUCH DES GERÄTES ERHALTEN HABEN UND DIE DAMIT VERBUNDENEN GEFAHREN VERSTEHEN. KINDER DÜRFEN NICHT MIT DEM GERÄT SPIELEN. REINIGUNG UND BENUTZERWARTUNG DÜRFEN NICHT VON KINDERN OHNE BEAUFSICHTIGUNG DURCHFÜHRT WERDEN.**

### Symbole

Die folgenden Symbole werden für das Gerät verwendet. Machen Sie sich vor der Benutzung unbedingt mit ihrer Bedeutung vertraut.



• Nur für trockene Räume



• DOPPELT SCHUTZISOLIERT



• Bitte Bedienungsanleitung lesen.



• Ladebereit



- Akku wird geladen



- Ladungsverzögerung (Akku ist abgekühlt oder zu kalt)



- Anpassungsladung



- Schließen Sie die Kontakte nicht kurz. Brandgefahr!



- Setzen Sie den Akku weder Wasser noch Regen aus.



- Nur für EU-Länder  
Werfen Sie Elektrogeräte oder Akkus nicht in den Hausmüll!  
Gemäß den Europäischen Richtlinien für Elektro- und Elektronik-Altgeräte, für Batterien, Akkus sowie verbrauchte Batterien und Akkus und ihre Umsetzung gemäß den Landesgesetzen müssen Elektrogeräte, Batterien und Akkus, die das Ende ihrer Lebensdauer erreicht haben, getrennt gesammelt und einer umweltgerechten Recycling-Einrichtung zugeführt werden.



- Laden beendet



- Akku defekt



- Kühlungsstörung



- Werfen Sie den Akku nicht ins Feuer.



- Verbrauchte Akkus stets dem Recycling zuführen.

1. BEWAHREN SIE DIESE ANWEISUNGEN SORGFÄLTIG AUF – Diese Bedienungsanleitung enthält wichtige Sicherheits- und Gebrauchsanweisungen für das Ladegerät.
2. Lesen Sie vor der Benutzung des Ladegeräts alle Anweisungen und Warnhinweise, die an (1) Ladegerät, (2) Akku und (3) Akkuwerkzeug angebracht sind.
3. VORSICHT – Um die Verletzungsgefahr zu reduzieren, dürfen nur Makita-Akkus verwendet werden. Andere Akkutypen können platzen und Verletzungen oder Sachschäden verursachen.
4. Nicht aufladbare Batterien können mit diesem Ladegerät nicht aufgeladen werden.
5. Achten Sie darauf, dass die Spannung der Stromquelle mit der auf dem Typenschild des Ladegeräts angegebenen Spannung übereinstimmt.
6. Laden Sie den Akku nicht in Gegenwart von brennbaren Flüssigkeiten oder Gasen.
7. Setzen Sie das Ladegerät weder Regen noch Schnee aus.
8. Tragen Sie das Ladegerät niemals am Netzkabel, und reißen Sie niemals daran, um es von der Steckdose zu trennen.
9. Trennen Sie das Ladegerät nach dem Laden oder vor jedem Versuch einer Wartung oder Reinigung von der Stromquelle. Ziehen Sie immer am Stecker, niemals am Kabel, um das Ladegerät von der Stromquelle zu trennen.
10. Verlegen Sie das Netzkabel so, dass niemand darauf tritt oder darüber stolpert, und dass es keinen sonstigen schädlichen Einflüssen oder Belastungen ausgesetzt wird.
11. Betreiben Sie das Ladegerät nicht mit einem beschädigten Netzkabel oder Netzstecker. Falls das Kabel oder der Stecker beschädigt ist, lassen Sie das beschädigte Teil von einer autorisierten Makita-Kundendienststelle austauschen, um einer Gefahr vorzubeugen.
12. Benutzen oder zerlegen Sie das Ladegerät nicht, wenn es einen harten Schlag erlitten hat, fallen gelassen oder sonst wie beschädigt worden ist, sondern bringen Sie es zu einem qualifizierten Kundendiensttechniker. Falscher Gebrauch oder Zusammenbau kann die Ursache für elektrische Schläge oder einen Brand sein.
13. Laden Sie den Akku nicht bei Raumtemperaturen UNTER 10°C oder ÜBER 40°C. Bei niedrigen Temperaturen beginnt der Ladevorgang u. U. nicht.
14. Das Ladegerät darf nicht an einen Aufwärtstransformator, Generator oder eine Gleichstrom-Steckdose angeschlossen werden.
15. Achten Sie darauf, dass die Lüftungsschlitze des Ladegerätes nicht abgedeckt oder blockiert werden.
16. Stecken Sie keinen Nagel, Draht usw. in den USB-Stromversorgungsanschluss.

### Laden für MAKITA-Akkus

Dieses Ladegerät kann zwei Akkus gleichzeitig laden.

1. Schließen Sie das Ladegerät an eine geeignete Wechselstromquelle an. Die Ladekontrolllampe blinkt wiederholt in Grün.
2. Richten Sie den Akku auf die Führung des Ladegerätes aus, und führen Sie ihn bis zum Anschlag ein. Die Kontaktabdeckung des Ladegerätes wird durch Einschieben des Akkus geöffnet und durch Herausziehen des Akkus geschlossen.
3. Wenn der Akku eingesetzt wird, leuchtet die rote Ladekontrolllampe auf, und der Ladevorgang beginnt mit einer kurzen voreingestellten Melodie zur Bestätigung des Tons, der den Abschluss des Ladevorgangs meldet.
4. Wenn der Ladevorgang beendet ist, wechselt die Ladekontrolllampe von Rot auf Grün, und eine Melodie oder ein Summton (langer Piepton) wird abgegeben, um den Abschluss des Ladevorgangs zu melden.
5. Die Ladezeit ist je nach der Temperatur (10°C – 40°C), bei welcher der Akku geladen wird, und dem Zustand des Akkus (z.B. neuer oder längere Zeit unbenutzter Akku) unterschiedlich.
6. Nach dem Laden nehmen Sie den Akku aus dem Ladegerät heraus, und trennen Sie das Ladegerät vom Stromnetz.

### Ändern der Ladevorgangs-Abschlussmelodie

1. Setzen Sie den Akku in den Ladesteckplatz ein, dessen Ladevorgangs-Abschlussmelodie Sie ändern wollen. Daraufhin wird die letzte voreingestellte Ladevorgangs-Abschlussmelodie kurz angespielt.
2. Wird der Akku innerhalb von fünf Sekunden nach dem Entfernen wieder eingesetzt, ändert sich die Melodie.
3. Mit jedem weiteren Entfernen und Wiedereinsetzen innerhalb von fünf Sekunden wird die nächste Melodie aktiviert.
4. Wenn die gewünschte Melodie abgegeben wird, lassen Sie den Akku eingesetzt, um den Ladevorgang zu starten. Wenn der Modus "kurzer Piepton" gewählt wird, wird kein Ladevorgangs-Abschlussignal abgegeben. (Stumm-Modus)
5. Wenn der Ladevorgang beendet ist, bleibt die grüne Lampe erleuchtet, während die rote Lampe erlischt und die beim Einsetzen des Akkus voreingestellte Melodie oder ein Summton (langer Piepton) ertönt, um den Abschluss des Ladevorgangs zu melden. (Wenn der Stumm-Modus gewählt wird, werden keine Signaltöne abgegeben.)
6. Die voreingestellte Melodie bleibt gespeichert, selbst wenn das Ladegerät von der Stromquelle getrennt wird.

Spannung	9,6 V	12 V	14,4 V	Leistung (Ah)	Ladezeit (Minuten)
Anzahl der Zellen	8	10	12		
Ni-MH-Akku	BH9020A	—	—	2,0	20
	—	BH1220/C	BH1420	2,0	15
	BH9033A	—	—	3,3	30
	—	BH1233/C	BH1433	3,3	22

Spannung	14,4 V	18 V	14,4 V	18 V	Leistung (Ah) nach IEC61960	Ladezeit (Minuten)
Anzahl der Zellen	4	5	8	10		
Li-ion-Akku	BL1415	BL1815	—	—	1,3	15
	—	—	BL1430/A	BL1830	3,0	22
	BL1415N/ BL1415NA	BL1815N	—	—	1,5	15
	—	BL1820/ BL1820B	—	—	2,0	24
	—	—	BL1440	BL1840/ BL1840B	4,0	36
	—	—	BL1450	BL1850/ BL1850B	5,0	45
—	—	—	BL1860B	6,0	55	

#### HINWEIS:

- Das Ladegerät ist ausschließlich zum Laden von Makita-Akkus vorgesehen. Verwenden Sie es auf keinen Fall für einen anderen Zweck oder zum Laden von Akkus anderer Fabrikate.
- Wenn ein neuer oder längere Zeit unbenutzter Akku geladen wird, akzeptiert er möglicherweise eine volle Ladung erst, nachdem er mehrmals völlig entladen und wieder aufgeladen worden ist. (Nur Ni-MH-Akku)
- Falls die Ladekontrolllampe in Rot blinkt, liegen folgende Akkuzustände vor, und der Ladevorgang beginnt u. U. nicht.
  - Der Akku wurde von einem kurz zuvor benutzten Werkzeug abgenommen, oder der Akku wurde an einem Ort liegen gelassen, der lange Zeit direktem Sonnenlicht ausgesetzt war.

- Der Akku wurde für lange Zeit an einem Ort liegen gelassen, der Kaltluft ausgesetzt war.
- Wenn der Akku zu heiß ist, beginnt der Ladevorgang erst, nachdem das im Ladegerät eingebaute Kühlgebläse den Akku abgekühlt hat. Der Ladevorgang beginnt erst, nachdem die Akkuteperatur ein Niveau erreicht hat, bei dem Laden möglich ist.
- Falls die Ladekontrolllampe abwechselnd in Grün und Rot blinkt, liegt eine Störung vor, und der Akku kann nicht geladen werden. Möglicherweise sind die Kontakte des Ladegerätes oder des Akkus verschmutzt, oder der Akku ist verbraucht oder beschädigt.

#### Kühlsystem

- Dieses Ladegerät ist mit einem Kühlgebläse für erhitze Akkus ausgestattet, um die Leistung des Akkus zu verbessern. Das vom Kühlgebläse erzeugte Laufgeräusch ist normal und stellt kein Anzeichen für eine Störung des Ladegerätes dar.
  - Eine gelbe Lampe blinkt in den folgenden Fällen als Warnsignal.
    - Störung des Kühlgebläses
    - Unvollständige Kühlung des Akkus, z.B. bei Verstopfung mit Staub
- Der Akku kann trotz der gelben Warnlampe weiter aufgeladen werden. Aber in diesem Fall ist die Ladezeit länger als gewöhnlich.

- Überprüfen Sie das Laufgeräusch des Kühlgebläses und die Ventilationsöffnungen an Ladegerät und Akku, die sich manchmal mit Staub zusetzen können.
- Wenn die gelbe Warnlampe nicht blinkt, ist das Kühlsystem in Ordnung, selbst wenn kein Laufgeräusch des Kühlgebläses vernehmbar ist.
- Halten Sie die Ventilationsöffnungen an Ladegerät und Akku stets sauber, um einwandfreie Kühlung zu gewährleisten.
- Falls die gelbe Warnlampe häufig blinkt, sollten Sie die Produkte zwecks Reparatur oder Wartung einsenden.

#### Anpassungsladung

Eine Anpassungsladung kann die Lebensdauer eines Akkus dadurch verlängern, dass in jeder Situation automatisch die optimalen Ladebedingungen für den Akku gesucht werden. Unter folgenden Bedingungen erfordert der verwendete Akku eine wiederholte "Anpassungsladung", um schnelle Erschöpfung zu verhüten. In diesem Fall leuchtet die gelbe Lampe auf.

1. Nachladen eines Akkus bei hoher Temperatur
  2. Nachladen eines Akkus bei niedriger Temperatur
  3. Nachladen eines voll aufgeladenen Akkus
  4. Übermäßiges Entladen eines Akkus (fortgesetztes Entladen eines bereits erschöpften Akkus.)
- Die Ladezeit eines solchen Akkus ist länger als gewöhnlich.

#### Verwendung mit USB-Gerät

Dieses Ladegerät kann als externe Stromquelle für ein USB-Gerät verwendet werden.

1. Öffnen Sie die Abdeckung des USB-Stromversorgungsanschlusses. Schließen Sie das USB-Kabel an den USB-Stromversorgungsanschluss und das USB-Gerät an.
2. Schließen Sie das Ladegerät an eine Stromquelle an.
3. Trennen Sie das Ladegerät nach dem Ladevorgang ab.

#### Hinweis:

- Bevor Sie ein USB-Gerät an das Ladegerät anschließen, sollten Sie stets die Daten Ihres USB-Geräts sichern. Anderenfalls können Ihre Daten womöglich verloren gehen.
- Manche USB-Geräte können u. U. nicht über das Ladegerät mit Strom versorgt werden.
- Trennen Sie das USB-Kabel bei Nichtbenutzung oder nach dem Laden ab, und schließen Sie die Abdeckung.

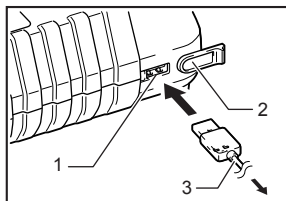















1. USB-Stromversorgungsanschluss
2. Abdeckung
3. USB-Kabel

**AVVERTIMENTO: QUESTO UTENSILE PUÒ ESSERE USATO DAI BAMBINI DI 8 ANNI E OLTRE, E DALLE PERSONE CON CAPACITÀ FISICHE, SENSORIALI O MENTALI RIDOTTE, O SENZA ESPERIENZA O CONOSCENZA, SE SONO SOTTO LA SUPERVISIONE O HANNO RICEVUTO LE ISTRUZIONI PER L'UTILIZZO SICURO DELL'UTENSILE E CAPISCONO I RISCHI CHE COMPORTA. I BAMBINI NON DEVONO GIOCARE CON L'UTENSILE. LA PULIZIA E LA MANUTENZIONE NON DEVONO ESSERE FATTE DAI BAMBINI SENZA SUPERVISIONE.**

**Simboli**

Per questo apparecchiature vengono usati i simboli seguenti. Bisogna capire il loro significato prima di usare l'apparecchiature.

-  • Da usare solo al coperto
-  • **DOPPIO ISOLAMENTO**
-  • In carica
-  • Sospendere la carica (Raffreddamento della batteria o batteria troppo fredda)
-  • Condizionamento
-  • Non ponete le batterie in corto circuito.
-  • Non esporre la batteria all'acqua o alla pioggia.
-  • Solo per Paesi UE  
Non gettare gli apparecchi elettrici o il pacco batteria con l'immondizia.
-  • Leggete il manuale di istruzioni.
-  • Pronto per la carica
-  • Completamento della carica
-  • Batteria difettosa
-  • Problema di raffreddamento
-  • Non distruggere la batteria con il fuoco.
-  • Riciclate sempre le batterie.

1. CONSERVARE QUESTE ISTRUZIONI – Questo manuale contiene importanti istruzioni per la sicurezza e il funzionamento del caricabatteria.
2. Prima di usare il caricabatteria, leggere tutte le istruzioni e le etichette precauzionali su (1) il caricabatteria, (2) la batteria e (3) il prodotto che utilizza la batteria.
3. **ATTENZIONE** – Per ridurre il rischio di incidenti, caricare soltanto il tipo di batterie ricaricabili Makita. Gli altri tipi di batterie potrebbero scoppiare causando incidenti e danni.
4. Con questo caricabatteria non si possono caricare le batterie non ricaricabili.
5. Usare una fonte di alimentazione con la tensione specificata sulla targhetta del nome del caricatore.
6. Non caricare la batteria dove ci sono liquidi o gas infiammabili.
7. Non esporre il caricatore alla pioggia o alla neve.
8. Il caricatore non deve mai essere trasportato tenendolo per il cavo, e non deve essere staccato dalla presa di corrente tirando il cavo.
9. Dopo la carica o prima di qualsiasi intervento di manutenzione o di pulizia, staccare il caricatore dalla fonte di alimentazione. Staccare sempre la spina e non tirare mai il cavo.
10. Accertarsi che il cavo sia disposto in modo da non essere calpestato, da non inciamparvi sopra e che sia altrimenti soggetto a danni o sollecitazioni.
11. Non usare il caricatore se ha il cavo o la spina danneggiati. Se il cavo o la spina sono danneggiati, rivolgersi a un centro di assistenza Makita autorizzato per farli riparare in modo da evitare un pericolo.
12. Il caricatore non deve essere fatto funzionare o smontato se ha ricevuto un forte colpo, se è caduto o presenta o qualsiasi danno: farlo riparare da una persona qualificata. Il suo uso o montaggio sbagliato potrebbe causare un pericolo di scosse elettriche o di incendio.
13. La cartuccia batteria non deve essere caricata quando la temperatura ambiente è **SOTTO** i 10°C o **SOPRA** i 40°C. La carica potrebbe non cominciare alle basse temperature.
14. Non si deve cercare di usare un trasformatore survolto, un generatore per motori o una presa in c.c.
15. Le aperture di ventilazione del caricatore non devono essere in alcun modo coperte o intasate.
16. Nella presa di alimentazione corrente USB non si devono inserire chiodi, fili metallici, ecc.

**Carica delle batterie MAKITA**

Questo caricatore può caricare due batterie allo stesso tempo.

1. Collegare il caricatore alla fonte di alimentazione c.a. corretta. La spia di carica lampeggia ripetutamente verde.
2. Inserire la cartuccia batteria nel caricatore finché non si arresta regolandola sulla guida del caricatore. Il coperchio del terminale del caricatore si apre quando si inserisce la cartuccia batteria, e si chiude quando la si estrae.
3. Quando si inserisce la batteria, la spia rossa di carica si accende e la carica comincia con un breve suono preregolato di indicazione del completamento della carica che si sente.
4. Alla fine della carica, la spia di carica cambia da rossa a verde e si sente il suono o il cicalino (un suono prolungato) di indicazione del completamento della carica.
5. Il tempo di carica differisce secondo la temperatura al momento della carica (10°C – 40°C) o delle condizioni della batteria, come se è nuova o non è stata usata per un lungo periodo di tempo.
6. Dopo la carica, rimuovere la batteria dal caricatore e staccare il caricatore dalla presa di corrente.

## Cambiamento del motivetto di indicazione del completamento della carica

- Inserire la cartuccia batteria nella porta di carica di cui si desidera cambiare il motivetto di indicazione del completamento della carica. Ciò fa sentire l'ultimo motivetto di indicazione del completamento della carica prerogolato.
- La rimozione e il reinserimento della batteria entro cinque secondi dopo ciò fa cambiare il suono.
- Ogni volta che si rimuove e si reinserisce la batteria entro i successivi cinque secondi dopo ciò, il suono cambia in sequenza.
- Quando si sente il suono desiderato, lasciare inserita la batteria e la carica comincia. Se si seleziona la modalità "Suono breve", non si hanno i segnali di carica completata (modalità di silenziamento).
- Alla fine della carica, la spia di carica rimane accesa, la spia rossa si spegne e si sente il suono prerogolato al momento dell'inserimento della batteria o il cicalino (suono prolungato) di indicazione del completamento della carica. (Nella modalità di silenziamento selezionata, non si sente il suono.)
- Il suono prerogolato rimane memorizzato anche se si stacca il caricatore dalla presa di corrente.

Tensione	9,6 V	12 V	14,4 V	Capacità (Ah)	Tempo di carica (minuti)
Numero di celle	8	10	12		
Batteria Ni-MH	BH9020A	—	—	2,0	20
	—	BH1220/C	BH1420	2,0	15
	BH9033A	—	—	3,3	30
	—	BH1233/C	BH1433	3,3	22

Tensione	14,4 V	18 V	14,4 V	18 V	Capacità (Ah) in base IEC61960	Tempo di carica (minuti)
Numero di celle	4	5	8	10		
Batteria Li-ion	BL1415	BL1815	—	—	1,3	15
	—	—	BL1430/A	BL1830	3,0	22
	BL1415N/ BL1415NA	BL1815N	—	—	1,5	15
	—	BL1820/ BL1820B	—	—	2,0	24
	—	—	BL1440	BL1840/ BL1840B	4,0	36
	—	—	BL1450	BL1850/ BL1850B	5,0	45
—	—	—	BL1860B	6,0	55	

### NOTA:

- Il caricabatteria serve esclusivamente a caricare le cartucce batteria Makita. Mai usarlo per altri scopi o per caricare batterie di altre marche.
- Quando si carica una batteria nuova o che non è stata usata per un lungo periodo di tempo, essa potrebbe non accettare una carica completa finché non viene scaricata completamente e ricaricata un paio di volte. (Solo la batteria Ni-MH)
- Se la spia di carica lampeggia rossa, la condizione della batteria è come indicata sotto e la carica potrebbe non cominciare.
  - Cartuccia batteria dell'utensile appena usato o cartuccia batteria che è rimasta in un luogo esposto alla luce diretta del sole per un lungo periodo di tempo.

- Cartuccia batteria che è rimasta in un luogo esposto all'aria fredda per un lungo periodo di tempo. Se la cartuccia batteria è troppo calda, la carica comincia dopo che la ventola di raffreddamento installata nel caricatore ha raffreddato la cartuccia batteria. La carica comincia dopo che la temperatura della cartuccia batteria ha raggiunto il grado che rende possibile la carica della batteria.
- Se la spia di carica lampeggia alternativamente in verde e in rosso, la carica non è possibile. I terminali del caricatore o della cartuccia batteria sono intasati di polvere o la cartuccia batteria è usurata o danneggiata.

### Sistema di raffreddamento

- Questo caricatore è dotato di una ventola di raffreddamento per quando la batteria si riscalda, in modo che la batteria possa provare le sue prestazioni. Durante il raffreddamento si sente il rumore dell'aria di raffreddamento che esce, il che significa che non ci sono problemi con il caricatore.
- Se una spia di avvertimento lampeggia in giallo nei casi seguenti:
  - Problema della ventola di raffreddamento
  - Raffreddamento incompleto della batteria, come quando c'è un intasamento di polvere
 La batteria può essere caricata anche se c'è la spia gialla di avvertimento. In questo caso, però, il tempo di carica è più lungo del normale.

- Controllare il rumore della ventola di raffreddamento, l'apertura di ventilazione sul caricatore e la batteria per possibili intasamenti di polvere.
- Il sistema di raffreddamento è normale anche se non si sente il rumore della ventola se la spia gialla di avvertimento non lampeggia.
- Per il raffreddamento, mantenere sempre pulita l'apertura di ventilazione del caricatore e della batteria.
- Se la spia gialla di avvertimento lampeggia frequentemente, i prodotti devono essere spediti per la riparazione o la manutenzione.

### Carica di condizionamento

La carica di condizionamento può estendere la vita della batteria cercando automaticamente la condizione di carica ottimale della batteria in ogni situazione. La batteria usata ripetutamente nelle condizioni seguenti richiede la "carica di condizionamento" per evitare l'usura veloce. In tal caso, si accende la spia gialla.

- Quando viene ricaricata alle alte temperature
  - Quando viene ricaricata alle basse temperature
  - Se viene ricaricata quando è completamente carica
  - Se viene scaricata eccessivamente (si continua a scaricare la batteria anche se è debole)
- Il tempo di carica di tale batteria diventa allora più lungo del normale.

## Utilizzo con il dispositivo USB

Questo caricatore funziona da alimentazione di corrente esterna del dispositivo USB.

1. Aprire il coperchio della presa di alimentazione corrente USB. Collegare il cavo USB alla presa di alimentazione corrente USB e al dispositivo USB.
2. Collegare il caricatore a una fonte di alimentazione di corrente.
3. Staccare il caricatore dopo la carica.

### Nota:

- Prima di collegare il dispositivo USB al caricatore, eseguire sempre il backup dei dati del dispositivo USB. I dati potrebbero altrimenti andare persi per un qualsiasi motivo.
- Il caricatore potrebbe non alimentare la corrente ad alcuni dispositivi USB.
- Se non lo si usa, o dopo la carica, rimuovere il cavo USB e chiudere il coperchio.

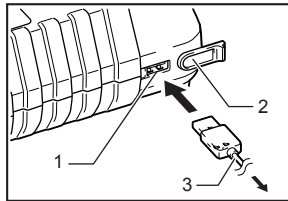

1. Presa di alimentazione corrente USB
2. Coperchio
3. Cavo USB

## NEDERLANDS

**WAARSCHUWING: DIT APPARAAT MAG WORDEN GEBRUIKT DOOR KINDEREN VAN 8 JAAR EN OUDER OF DOOR PERSONEN MET BEPERKTE FYSIEKE, ZINTUIGLIJKE OF VERSTANDELIJKE VERMOGENS OF GEBREK AAN ERVARING OF KENNIS VAN ZAKEN, MAAR ALLEEN ONDER TOEZICHT OF NA INSTRUCTIE IN VEILIG GEBRUIK VAN HET APPARAAT, MET BEGRIP VAN DE EVENTUELE RISICO'S. KINDEREN MOGEN NIET MET HET APPARAAT SPELEN. REINIGEN EN ONDERHOUD VAN HET APPARAAT MAG NIET DOOR KINDEREN WORDEN VERRICHT, TENZIJ ONDER TOEZICHT.**

### Symbolen

Voor dit apparaat worden de volgende symbolen gebruikt. Zorg ervoor dat u de betekenis van deze symbolen begrijpt alvorens het apparaat te gebruiken.



- Alleen voor gebruik binnenshuis



- DUBBELE ISOLATIE



- Bezig met opladen



- Vertraagd opladen (accu koelt af of te koude accu)



- Optimaal heropladen



- Voorkom kortsluitingen.



- Stel de batterij niet bloot aan water of regen.



- Alleen voor EU-landen

Geef elektrische apparatuur of accu's niet met het huishoudelijk afval mee!

Met inachtneming van de Europese Richtlijnen betreffende afgedankte elektrische en elektronische apparatuur, batterijen en accu's inclusief opgebruikte batterijen en accu's, en de implementatie van deze richtlijnen in overeenstemming met nationale wetgeving, moeten elektrische apparaten, batterijen en accu's die het einde van hun levensduur bereikt hebben, gescheiden worden ingezameld en worden ingeleverd bij een recyclingbedrijf dat aan de milieurechtlijnen voldoet.



- Lees de gebruiksaanwijzing.



- Gereed voor opladen



- Opladen voltooid



- Defecte accu



- Koelsysteem werkt niet juist



- Vernietig de batterij niet in een vuur.



- Recycle altijd de accu's.

1. BEWAAR DEZE INSTRUCTIES – Deze gebruiksaanwijzing bevat belangrijke veiligheids- en bedieningsinstructies voor de acculader.
2. Alvorens de acculader in gebruik te nemen, leest u eerst alle instructies en waarschuwingsofschriften op (1) de acculader, (2) de accu en (3) het apparaat waarin de accu wordt aangebracht.
3. LET OP – Om de kans op letsel te verkleinen, mag u alleen oplaadbare accu's van het Makita-type opladen. Andere typen accu's kunnen barsten waardoor persoonlijk letsel of schade kan worden veroorzaakt.
4. Niet-oplaadbare accu's kunnen niet worden opgeladen met deze acculader.
5. Gebruik een stroomvoorziening met een spanning aangegeven op het typeplaatje van de acculader.

- Laadt de accu niet op in de buurt van ontvlambare vloeistoffen of gassen.
- Stel de acculader niet bloot aan regen of sneeuw.
- Draag de acculader nooit aan het netsnoer en trek nooit aan het netsnoer om zo de stekker uit het stopcontact te trekken.
- Na het opladen of voordat u de acculader onderhoudt of schoonmaakt, trekt u de stekker van de acculader uit het stopcontact. Trek aan de stekker en niet aan het netsnoer.
- Zorg ervoor dat het netsnoer op een plaats ligt waar er niet op wordt gestaan, over gestruikeld of anderszins blootgesteld aan beschadiging of krachten.
- Gebruik de acculader niet met een beschadigd snoer of een kapotte stekker. Als het snoer of de stekker beschadigd is, vraagt u dan een bevoegd Makita servicecentrum om het te vervangen, om risico te voorkomen.
- Gebruik de acculader niet en haal hem niet uit elkaar nadat deze is blootgesteld aan een zware schok, is gevallen of op een andere manier is beschadigd, maar breng deze naar een vakbekwame reparateur. Door onjuist gebruik of in elkaar zetten kan een risico van elektrische schokken of brand ontstaan.
- Laad de accu niet op wanneer de kamertemperatuur LAGER is dan 10°C of HOGER dan 40°C. Bij lage temperaturen kan soms het opladen niet beginnen.
- Gebruik geen spanningstransformator, motorgenerator of gelijkspanningsstopcontact.
- Zorg ervoor dat de ventilatieopeningen van de acculader niet worden afgedekt of geblokkeerd.
- Steek geen draden, paperclips of spelden e.d. in de USB-stroomtoevoeraansluiting.

### Opladen van MAKITA accu's

Met deze acculader kunt u twee accu's tegelijk opladen.

- Sluit de acculader aan op een gewoon stopcontact met het juiste wisselstroomvoltagte. Het laadlampje knippert groen.
- Volg de aanduidingen op de acculader en schuif de accu zo ver mogelijk in de acculader. Het deksel van de acculader gaat open wanneer u de accu erin steekt, en gaat weer dicht wanneer u de accu eruit haalt.
- Nadat de accu in de acculader is gestoken, brandt het laadlampje rood en begint het opladen waarbij kortstondig een vooraf ingestelde einde-opladen-melodie klinkt om aan te geven dat het opladen is begonnen.
- Nadat het opladen is voltooid, verandert het laadlampje van rood naar groen en klinkt de einde-opladen-melodie of de zoemer (lange pieptoon) om aan te geven dat het opladen voltooid is.
- De laadtijd varieert met de temperatuur (10°C – 40°C) waarbij de accu wordt opgeladen en met de toestand van de accu, bijvoorbeeld een accu die nieuw is of lange tijd niet is gebruikt.
- Na het opladen haalt u de accu uit de acculader en trekt u de stekker uit het stopcontact.

### Wijzigen van het melodietje voor voltooid opladen

- Plaats een accu in het oplaadstation waarvoor u de melodie voor voltooid opladen wilt wijzigen. Dan klinkt het laatste vooringestelde melodietje voor voltooid opladen.
- Als u binnen vijf seconden de accu eruit haalt en weer erin steekt, verandert de melodie.
- Iedere keer wanneer u de accu binnen vijf seconden eruit haalt en weer erin steekt, verandert de melodie op volgorde.
- Wanneer de gewenste melodie klinkt, laat u de accu in de acculader zitten zodat het opladen begint. Als de korte pieptoon is geselecteerd, zal geen einde-opladen-melodie klinken nadat het opladen is voltooid (geluidloze functie).
- Nadat het opladen is voltooid, blijft het groene laadlampje branden en gaat het rode laadlampje uit, en klinkt de melodie die is ingesteld toen de accu erin werd gestoken of de zoemer (lange pieptoon) om aan te geven dat het opladen voltooid is. (Als de stille functie is geselecteerd, klinkt geen melodie.)
- De ingestelde melodie wordt onthouden, ook als de stekker van de acculader uit het stopcontact wordt getrokken.

Spanning	9,6 V	12 V	14,4 V	Capaciteit (A/uur)	Oplaaftijd (minuten)
Aantal cellen	8	10	12		
Ni-MH accu	BH9020A	—	—	2,0	20
	—	BH1220/C	BH1420	2,0	15
	BH9033A	—	—	3,3	30
	—	BH1233/C	BH1433	3,3	22

Spanning	14,4 V	18 V	14,4 V	18 V	Capaciteit (A/uur) volgens de IEC61960	Oplaaftijd (minuten)
Aantal cellen	4	5	8	10		
Li-ion accu	BL1415	BL1815	—	—	1,3	15
	—	—	BL1430/A	BL1830	3,0	22
	BL1415N/ BL1415NA	BL1815N	—	—	1,5	15
	—	BL1820/ BL1820B	—	—	2,0	24
	—	—	BL1440	BL1840/ BL1840B	4,0	36
	—	—	BL1450	BL1850/ BL1850B	5,0	45
	—	—	—	BL1860B	6,0	55

### OPMERKING:

- De acculader is uitsluitend bestemd voor het opladen van Makita accu's. Gebruik deze nooit voor andere doeleinden of voor het opladen van accu's van andere fabrikanten.
- Een nieuwe accu of een accu die gedurende lange tijd niet werd gebruikt kan soms niet volledig worden opgeladen totdat u hem een paar keer volledig hebt ontladen en herladen. (Alleen Ni-MH accu)
- Als het oplaadlampje rood knippert, is de toestand van de accu zoals hieronder beschreven en start het opladen mogelijk niet.
  - De accu is net nog gebruikt in het gereedschap, of de accu heeft langdurig op een plaats gelegen die was blootgesteld aan direct zonlicht.
  - De accu heeft langdurig op een plaats gelegen die was blootgesteld aan koude lucht.
  - Wanneer de accu te heet is, begint het opladen nadat de koelventilator in de acculader de accu heeft afgekoeld. Het opladen begint nadat de temperatuur is gedaald tot het niveau waarop opladen mogelijk is.
  - Indien het oplaadlampje afwisselend in groen en rood knippert, is opladen niet mogelijk. De klemmen op de accu of acculader zijn met vuil verstopt, of de accu is versleten of beschadigd.



## Koelsysteem

- Deze acculader is voorzien van een ventilator voor het afkoelen van een warmgeworden accu om verslechtering van de accuprestaties te voorkomen. Tijdens het koelen zult u het geluid van de koelingslucht horen. Dit is normaal en betekent niet dat er iets mankeert aan de acculader.
  - Een geel waarschuwingsslampje zal knipperen in de volgende gevallen.
    - Er mankeert iets aan de koelventilator.
    - De accu wordt slecht afgekoeld omdat deze verstopt is met stof e.d.
- Zelfs wanneer het gele waarschuwingsslampje knippert, kan de accu worden opgeladen. In dat geval zal het opladen echter langer duren dan normaal.

## Optimaal heropladen

De functie voor optimaal heropladen verlengt de levensduur van de accu door de optimale oplaadconditie van de accu in elke situatie automatisch te bepalen.

Wanneer de accu herhaaldelijk in de volgende omstandigheden wordt gebruikt, is "optimaal heropladen" vereist om te voorkomen dat de accu rap verslijt. In dat geval zal het gele lampje branden.

## Gebruik met een USB-apparaat

Deze acculader werkt als externe stroombron voor een USB-apparaat.

1. Open het deksel van de USB-stroomtoevoeraansluiting. Sluit het USB-aansluitsnoer aan op de USB-stroomtoevoeraansluiting en op het USB-apparaat.
2. Sluit de acculader aan op een stopcontact.
3. Na het opladen trekt u de stekker van de acculader uit het stopcontact.

### Opmerking:

- Voordat u een USB-apparaat op de acculader aansluit, stelt u eerst de gegevens van uw USB-apparaat veilig. Dit om eventueel verlies van gegevens te voorkomen.
- De acculader kan soms bepaalde USB-apparaten niet van stroom voorzien.
- Wanneer u het apparaat niet gebruikt, of na afloop van het opladen, verwijdt u het USB-aansluitsnoer en sluit u het deksel.

Controleer of het geluid van de koelventilator normaal is. Controleer ook of de luchtuitlaatopeningen op de accu en de acculader niet door stof verstopt zijn.

- Indien het gele waarschuwingsslampje niet knippert hoewel u geen geluid van de koelventilator hoort, is het koelsysteem in orde.
- Houd de luchtuitlaatopeningen op de acculader en de accu altijd schoon om een goede koeling te verzekeren.
- Indien het gele waarschuwingsslampje vaak gaat knipperen, moet u de producten naar een servicecentrum zenden voor reparatie of onderhoud.

1. Een accu bij een te hoge temperatuur opladen
2. Een accu bij een te lage temperatuur opladen
3. Een volledig opgeladen accu opnieuw opladen
4. Een accu te veel ontladen (de accu blijven gebruiken hoewel deze bijna leeg is)

Het opladen van een dergelijke accu duurt langer dan normaal.

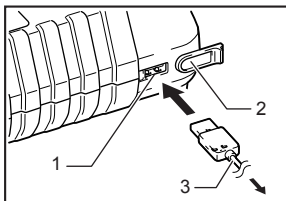

1. USB-stroomtoevoeraansluiting
2. Deksel
3. USB-aansluitsnoer

## ESPAÑOL

**ADVERTENCIA:** ESTE APARATO PUEDE SER UTILIZADO POR NIÑOS DE 8 O MÁS AÑOS DE EDAD Y PERSONAS CON CAPACIDADES FÍSICAS, SENSORIALES O MENTALES MERMADAS, O SIN EXPERIENCIA Y CONOCIMIENTO, SI HAN RECIBIDO SUPERVISIÓN O INSTRUCCIÓN PARA EL USO DEL APARATO DE FORMA SEGURA Y SON CONSCIENTES DEL PELIGRO QUE IMPLICA. LOS NIÑOS NO DEBEN JUGAR CON EL APARATO. LA LIMPIEZA Y MANTENIMIENTO QUE DEBE HACER EL USUARIO NO DEBEN SER REALIZADOS POR NIÑOS SIN SUPERVISIÓN.

## Símbolos

A continuación se muestran los símbolos utilizados con este aparato. Asegúrese de que entiende su significado antes de usarlo.



- Usar sólo en interiores



- DOBLE AISLAMIENTO



- Cargando



- Retraso de la carga (La batería se está enfriando o está muy fría)



- Acondicionamiento



- Lea el manual de instrucciones.



- Preparación para la carga



- Completada la carga



- Batería defectuosa



- Anormalidad en la carga



- No hacerles hacer cortocircuito a las baterías.



- No destruya la batería mediante fuego.



- No exponga la batería al agua ni a la lluvia.



- Reutilizar siempre las baterías.



- Sólo para países de la Unión Europea  
 ¡No tire aparatos eléctricos ni baterías a la basura con los residuos domésticos!  
 En conformidad con las Directivas Europeas, sobre residuos de aparatos eléctricos y electrónicos y sobre baterías y acumuladores y residuos de baterías y de acumuladores y su aplicación de acuerdo con la legislación nacional, los aparatos eléctricos y las baterías cuya vida útil haya llegado a su fin se deberán recoger por separado y trasladar a una planta de reciclaje que cumpla con las exigencias ecológicas.

1. GUARDE ESTAS INSTRUCCIONES – Este manual contiene instrucciones de seguridad y funcionamiento importantes para el cargador de baterías.
2. Antes de utilizar el cargador de baterías, lea todas las instrucciones e indicaciones de precaución sobre (1) el cargador de baterías, (2) la batería, y (3) el producto con el que se utiliza la batería.
3. PRECAUCIÓN – Para reducir el riesgo de sufrir heridas, cargue solamente baterías recargables tipo Makita. Otros tipos de baterías podrán reventar ocasionando heridas personales y daños.
4. Con este cargador de baterías no se pueden cargar baterías no recargables.
5. Utilice una fuente de alimentación cuya tensión sea igual a la especificada en la placa de características del cargador.
6. No cargue el cartucho de batería en presencia de líquidos o gases inflamables.
7. No exponga el cargador a la lluvia ni a la nieve.
8. No coja nunca el cargador por el cable ni tire del cable para desconectarlo de la toma de corriente.
9. Después de efectuar la carga o antes de intentar cualquier mantenimiento o limpieza, desconecte el cargador de la toma de corriente. Tire de la clavija y no del cable siempre que quiera desconectar el cargador.
10. Asegúrese de que el cable quede tendido de forma que no lo pueda pisar, tropezar con él, ni que esté sometido a daños o fatigas de ningún tipo.
11. No utilice el cargador si su cable o clavija están dañados. Si el cable o la clavija están dañados, pida a un centro de servicio autorizado de Makita que los reemplace para evitar riesgos.
12. No utilice ni desarme el cargador si ha recibido un fuerte golpe, lo ha dejado caer, o si se ha dañado de cualquier otra forma: llévalo a un técnico cualificado para que se lo arregle. Una utilización incorrecta o montaje de sus piezas podrá acarrear un riesgo de descarga eléctrica o incendio.
13. No cargue el cartucho de batería cuando la temperatura esté por DEBAJO de los 10°C o por ENCIMA de los 40°C. A baja temperatura, es posible que la carga no se inicie.
14. No intente utilizar un transformador elevador de tensión, un generador a motor ni una toma de corriente de CC.
15. No permita que cosa alguna tape u obstruya los orificios de ventilación del cargador.
16. No inserte un clavo, alambre, etc., en el puerto USB de suministro de alimentación.

### Carga de baterías MAKITA

Este cargador puede cargar dos baterías al mismo tiempo.

1. Enchufe el cargador en una toma de corriente de la tensión de CA apropiada. La luz de carga parpadeará en color verde repetidamente.
2. Inserte el cartucho de batería en el cargador hasta que haga tope ajustándose a la guía del cargador. La tapa del terminal del cargador se abre al insertar el cartucho de batería y se cierra al sacarlo.
3. Cuando se inserte el cartucho de batería, se encenderá la luz de carga roja y comenzará la carga con un sonido de melodía breve programado emitido como aseguramiento del sonido que se emitirá para notificar la terminación de la carga.
4. Con la terminación de la carga, la luz de carga cambiará de rojo a verde una vez y se emitirá el sonido de melodía o sonido de zumbador (un pitido largo) para notificar la terminación de la carga.
5. El tiempo de carga varía en función de la temperatura (10°C – 40°C) a la que se carga el cartucho de batería y las condiciones del cartucho de batería, tal como si es un cartucho de batería nuevo o no ha sido utilizado durante un periodo de tiempo largo.
6. Después de cargar, extraiga el cartucho de batería del cargador y desenchufe el cargador.

### Cambio del sonido de melodía de carga terminada

1. Inserte el cartucho de batería en el puerto de carga cuyo sonido de melodía de carga terminada quiere cambiar. Sonará brevemente el último sonido de melodía de carga terminada programado.
2. El sonido de melodía puede cambiarse extrayendo y reinsertando antes de cinco segundos el cartucho de batería.
3. Cada vez que se extraiga y reinserte antes de otros cinco segundos, el sonido de melodía cambiará en orden.
4. Cuando se emita el sonido de melodía deseado, deje el cartucho de batería insertado y comenzará la carga. Cuando se seleccione el modo "pitido corto", no se emitirán señales de carga terminada. (Modo silencio)
5. Con la terminación de la carga, la luz verde permanece encendida, la luz roja se apaga y se emite el sonido de melodía programado al insertar el cartucho de batería o sonido de zumbador (un pitido largo) para notificar la terminación de la carga. (Si se ha seleccionado el modo silencio, no se emitirán sonidos.)
6. El sonido de melodía permanecerá almacenado aunque desenchufe el cargador.

Tensión	9,6 V	12 V	14,4 V	Capacidad (Ah)	Tiempo de carga (minutos)
Número de celdas	8	10	12		
Cartucho de batería Ni-MH	BH9020A	—	—	2,0	20
	—	BH1220/C	BH1420	2,0	15
	BH9033A	—	—	3,3	30
	—	BH1233/C	BH1433	3,3	22

Tensión	14,4 V	18 V	14,4 V	18 V	Capacidad (Ah) de acuerdo con IEC61960	Tiempo de carga (minutos)
Número de celdas	4	5	8	10		
Cartucho de batería Li-ion	BL1415	BL1815	—	—	1,3	15
	—	—	BL1430/A	BL1830	3,0	22
	BL1415N/ BL1415NA	BL1815N	—	—	1,5	15
	—	BL1820/ BL1820B	—	—	2,0	24
	—	—	BL1440	BL1840/ BL1840B	4,0	36
	—	—	BL1450	BL1850/ BL1850B	5,0	45
	—	—	—	BL1860B	6,0	55

#### NOTA:

- El cargador de baterías es sólo para cargar cartuchos de batería Makita. No lo utilice nunca con otros fines ni para baterías de otros fabricantes.
- Cuando cargue un cartucho de batería que sea nuevo o que no haya sido utilizado durante un largo periodo de tiempo, es posible que no acepte una carga completa hasta después de haberlo descargado completamente y vuelto a cargar unas cuantas veces. (Batería Ni-MH solamente)
- Si la luz de carga parpadea en color rojo, la condición de la batería será como se indica abajo y es posible que la carga no se inicie.

- Cartucho de batería de una herramienta recién utilizada o un cartucho de batería que ha sido dejado en un sitio expuesto a la luz directa del sol durante largo tiempo.
  - Cartucho de batería que ha sido dejado durante largo tiempo en un sitio expuesto a aire frío.
- Cuando el cartucho de batería esté muy caliente, la carga comenzará después de que el ventilador de enfriamiento instalado en el cargador enfríe el cartucho de batería. La carga comenzará después de que la temperatura del cartucho de batería alcance el grado al cual es posible cargar.
- Si la luz de carga parpadea alternativamente en color verde y rojo, la batería no se podrá cargar. Los terminales del cargador o de la batería estarán obstruidos con polvo o el cartucho de batería estropeado o dañado.

#### Sistema de enfriamiento

- Este cargador está equipado con un ventilador de enfriamiento para evitar el recalentamiento de la batería, y así poder sacarle a ésta el máximo rendimiento. Durante el enfriamiento se oye el sonido del ventilador, lo que significa que no hay ningún problema en el cargador.
  - En los siguientes casos parpadeará una luz amarilla de aviso.
    - Problema en el ventilador de enfriamiento
    - Batería no enfriada completamente, tal como, en el caso de que esté obstruida con polvo
- La batería se puede cargar aunque esté parpadeando la luz amarilla. Pero en este caso tardará más tiempo en cargarse.

- Verifique el sonido del ventilador de enfriamiento, el orificio de ventilación de la batería y la batería, porque algunas veces podrán estar obstruidos con polvo.
- Si la luz amarilla de aviso no parpadea, el sistema de enfriamiento estará bien aunque no se escuche el sonido del ventilador de enfriamiento.
  - Mantenga siempre limpios los orificios de ventilación del cargador y la batería.
  - Si la luz amarilla de aviso parpadea con frecuencia, el cargador deberá ser enviado a que lo reparen o le hagan el mantenimiento.

#### Carga de acondicionamiento

La carga de acondicionamiento puede alargar la vida útil de la batería buscando automáticamente la condición óptima para la carga de la batería en cualquier situación. La batería empleada en las siguientes condiciones repetidamente requerirá una "carga de acondicionamiento" para evitar que su vida de servicio no se acorte rápidamente. En ese caso, se encenderá la luz amarilla.

1. Si la carga estando caliente
  2. Si la carga estando fría
  3. Si la recarga estando completamente cargada
  4. Si la descarga demasiado (si continúa utilizándola a pesar de tener poca potencia.)
- El tiempo de carga de tal batería será más largo del normal.

#### Utilización con dispositivo USB

Este cargador funciona como fuente de alimentación externa para dispositivos USB.

1. Abra la tapa del puerto USB de suministro de alimentación. Conecte el cable USB al puerto USB de suministro de alimentación y el dispositivo USB.
2. Enchufe el cargador en una toma de corriente.
3. Después de efectuar la carga, desenchufe el cargador.

#### Nota:

- Antes de conectar un dispositivo USB al cargador, haga siempre una copia de seguridad de los datos del dispositivo USB. De lo contrario, podrá perder los datos debido a cualquier circunstancia.
- Es posible que el cargador no suministre alimentación a algunos dispositivos USB.
- Cuando no lo esté utilizando o después de cargar, retire el cable USB y cierre la tapa.

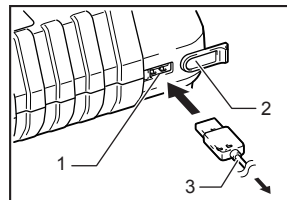

1. Puerto USB de suministro de alimentación
2. Tapa
3. Cable USB

**AVISO: ESTE APARELHO PODE SER UTILIZADO POR CRIANÇAS COM 8 ANOS E MAIS DE IDADE E POR PESSOAS COM CAPACIDADES FÍSICAS, SENSORIAIS OU MENTAIS REDUZIDAS OU COM FALTA DE EXPERIÊNCIA E CONHECIMENTO, SE TIVEREM RECEBIDO SUPERVISÃO OU INSTRUÇÕES RELATIVAS À UTILIZAÇÃO SEGURA DO APARELHO E CONHEÇAM OS RESPECTIVOS PERIGOS. AS CRIANÇAS NÃO DEVEM BRINCAR COM O APARELHO. A LIMPEZA E MANUTENÇÃO PELO UTILIZADOR NÃO DEVEM SER REALIZADAS POR CRIANÇAS SEM SUPERVISÃO.**

## Símbolos

O seguinte mostra os símbolos utilizados para o aparelho. Certifique-se de que compreende o seu significado antes da utilização.



• Usar só em interiores



• Leia o manual de instruções.



• DUPLO ISOLAMENTO



• Pronto a carregar



• A carregar



• Carga completa



• Carregamento retardado (Arrefecimento ou bateria fria demais)



• Bateria estragada



• Condicionado



• Arrefecimento anormal



• Não ponha as baterias em curto-circuito.



• Não queime a bateria.



• Não exponha a bateria a chuva ou a água.



• Recicle sempre as baterias.



• Apenas para países da UE

Não elimine equipamento eléctrico nem pack de baterias juntamente com lixo doméstico!

De acordo com as directivas europeias, relativas aos resíduos de equipamentos eléctricos e electrónicos e a pilhas e acumuladores e respectivos resíduos e a sua implementação em conformidade com as leis nacionais, o equipamento eléctrico e pilhas e pack(s) de baterias que tenham atingido o fim da sua vida devem ser recolhidos separadamente e encaminhados para a uma instalação de reciclagem ambientalmente compatível.

1. GUARDE ESTAS INSTRUÇÕES – Este manual contém importantes instruções de segurança e operação para o carregador de bateria.
2. Antes de utilizar o carregador de bateria, leia todas as instruções e etiquetas de precaução no (1) carregador de bateria, (2) bateria e (3) produto que utiliza a bateria.
3. PRECAUÇÃO – Para reduzir o risco de ferimentos, recarregue só baterias recarregáveis da Makita. Outros tipos de baterias podem vaziar provocando danos e ferimentos pessoais.
4. Baterias não-recarregáveis não podem ser utilizadas neste carregador de bateria.
5. Utilize uma fonte de alimentação com a voltagem especificada na placa de identificação do carregador.
6. Não carregue a bateria na presença de líquidos ou gases inflamáveis.
7. Não exponha o carregador de bateria à chuva ou neve.
8. Nunca transporte o carregador pegando pelo cabo nem dê um puxão para o desligar da tomada.
9. Depois do carregamento ou antes de executar qualquer manutenção ou limpeza, desligue o carregador da fonte de alimentação. Puxe pela ficha e nunca pelo cabo quando desliga o carregador.
10. Certifique-se de que o cabo esteja situado de modo a que não seja pisado, dobrado ou de qualquer modo sujeito a estragar-se ou ficar muito esticado.
11. Não funcione o carregador com o cabo ou ficha danificada. Se o cabo ou a ficha estiver danificada, solicite a sua substituição ao centro de assistência autorizado da Makita que para prevenir contra perigos potenciais.
12. Não funcione ou desmonte o carregador se tiver recebido uma pancada, caído ou de qualquer modo estragado; leve-o a um serviço de reparações. Montagem ou utilização incorrecta pode provocar choque eléctrico ou incêndio.
13. Não carregue a bateria quando a temperatura ambiente for INFERIOR a 10°C ou SUPERIOR a 40°C. Com temperaturas baixas, o carregamento pode não começar.
14. Não tente utilizar um transformador, um gerador ou um receptáculo de corrente CC.
15. Não permita que as ventilações do carregador fiquem cobertas ou obstruídas.
16. Não insira nenhum prego, fio, etc. na porta de alimentação de corrente USB.

## Carregamento das baterias MAKITA

Este carregador pode carregar duas baterias ao mesmo tempo.

1. Ligue o carregador numa fonte de alimentação CA adequada. A luz de carregamento piscará repetidamente em verde.
2. Coloque a bateria no carregador até que pare, ajustando com a guia no carregador. A cobertura dos terminais do carregador pode ser aberta colocando a bateria e fechada retirando-a.
3. Quando a bateria está colocada, a luz vermelha de carregamento acende-se, o carregamento começa e escuta uma melodia ajustada para lhe indicar qual o som que ouvirá a indicar que o carregamento terminou.

- Quando o carregamento termina, a luz de carregamento muda de vermelho um para verde um e escutará a melodia ou um sinal sonoro (um longo bip) para lhe indicar que o carregamento acabou.
- O tempo de carregamento varia com a temperatura (10°C – 40°C) a bateria é carregada e as condições da bateria, tal como se a bateria for nova ou não tiver sido utilizada durante um longo período de tempo.
- Depois de carregamento, retire a bateria do carregador e desligue o carregador da fonte de alimentação.

### Mudar o som da melodia do carregamento concluído

- Insira o cartucho da bateria dentro da porta do carregador que pretende mudar o som da melodia do carregamento concluído. Faz soar brevemente a última melodia predefinida do carregamento concluído.
- Retirar e voltar a colocar a bateria num espaço de cinco segundos faz com que a melodia mude.
- De cada vez que retira e volta a colocar a bateria, num espaço de cinco segundos, a melodia muda sequencialmente.
- Quando escuta a melodia que deseja, deixe a bateria colocada e o carregamento começa. Quando está seleccionado o modo "bip curto" não escutará o sinal de carregamento completo. (Modo silencioso).
- Quando o carregamento termina, a luz verde mantém-se acesa, a luz vermelha apaga-se e escuta o som da melodia ajustada quando colocou a bateria ou o sinal sonoro (um longo bip) para indicar que o carregamento terminou. (No modo silencioso não escuta nada.)
- O som da melodia ajustado mantém-se armazenado mesmo quando o carregador está desligado.

Voltagem	9,6 V	12 V	14,4 V	Capacidade (Ah)	Tempo de carregamento (minutos)
Número de células	8	10	12		
Bateria Ni-MH	BH9020A	—	—	2,0	20
	—	BH1220/C	BH1420	2,0	15
	BH9033A	—	—	3,3	30
	—	BH1233/C	BH1433	3,3	22

Voltagem	14,4 V	18 V	14,4 V	18 V	Capacidade (Ah) de acordo com IEC61960	Tempo de carregamento (minutos)
Número de células	4	5	8	10		
Bateria Li-ion	BL 1415	BL1815	—	—	1,3	15
	—	—	BL1430/A	BL1830	3,0	22
	BL1415N/ BL1415NA	BL1815N	—	—	1,5	15
	—	BL1820/ BL1820B	—	—	2,0	24
	—	—	BL1440	BL1840/ BL1840B	4,0	36
	—	—	BL1450	BL1850/ BL1850B	5,0	45
	—	—	—	BL1860B	6,0	55

### NOTA:

- O carregador de bateria é para carregar cartuchos de bateria da Makita. Nunca o utilize para outros fins ou baterias de outros fabricantes.
- Quando carrega uma bateria nova ou uma que não foi utilizada durante um longo período de tempo, pode não aceitar um carregamento completo até que a descarregue completamente e a volte a carregar algumas vezes. (Só a bateria Ni-MH)
- Se a luz de carregamento piscar em vermelho, significa que a condição da bateria está como abaixo e pode não iniciar o carregamento.

– A bateria estava numa ferramenta que acabou de funcionar ou foi deixada num local exposto à luz solar directa durante um longo período de tempo.

– A bateria foi deixada durante um longo período de tempo num local exposto ao ar frio.

Quando a bateria está muito quente, o carregamento começa depois que a ventoinha instalada no carregador arrefecer a bateria. O carregamento começará depois que a temperatura da bateria atingir o nível apropriado para o carregamento.

- Se a luz de carregamento piscar alternadamente em verde e vermelho, o carregamento não é possível. Os terminais no carregador ou bateria estão bloqueados com poeira ou a bateria está gasta ou estragada.

### Sistema de arrefecimento

- Este carregador está equipado com uma ventoinha de arrefecimento para quando a bateria está quente, para permitir que a bateria comprove o seu desempenho. Escuta o som da ventoinha durante o arrefecimento e não significa problema com o carregador.
- Uma luz amarela de aviso piscará nos seguintes casos:
  - Problema na ventoinha de arrefecimento
  - Arrefecimento incompleto da bateria talvez por estar bloqueada com poeira.

A bateria pode ser carregada apesar da luz amarela de aviso. Mas o tempo de carregamento será superior ao normal neste caso.

Verifique o som da ventoinha de arrefecimento, a ventilação no carregador e bateria, que podem estar bloqueadas com poeira.

- O sistema de arrefecimento está em condições apesar de não ouvir a ventoinha de arrefecimento, se a luz amarela de aviso não piscar.
- Mantenha sempre limpas as ventilações para arrefecimento no carregador e bateria.
- Deve mandar os produtos para reparação ou manutenção se a luz amarela de aviso piscar frequentemente.

### Carregamento condicionado

O carregamento condicionado pode aumentar a vida da bateria procurando automaticamente a condição óptima de carregamento para as baterias em todas as situações.

A bateria empregada nas seguintes condições repetidamente requer "carregamento condicionado" para evitar que se gaste rapidamente. Neste caso, a luz amarela acende-se.

- Carregamento da bateria com a temperatura máxima
- Carregamento da bateria com a temperatura mínima
- Carregamento de uma bateria completamente carregada
- Super-descarregamento da bateria (continuar a descarregar a bateria apesar de já estar fraca)

O tempo de carregamento de uma bateria nestas condições é superior.

## Utilizar com um dispositivo USB

Este carregador funciona como fonte de alimentação externa para um dispositivo USB.

1. Abra a tampa da porta de alimentação de corrente USB. Ligue o cabo USB à porta de alimentação de corrente USB e o dispositivo USB.
2. Ligue o carregador numa fonte de alimentação.
3. Depois de carregar, desligue o carregador.

### Nota:

- Antes de ligar o dispositivo USB ao carregador, crie sempre uma cópia de segurança dos dados do dispositivo USB. Caso contrário, há sempre a possibilidade de os seus dados serem perdidos.
- O carregador pode não fornecer energia a alguns dispositivos USB.

- Quando não está a ser utilizado, ou após o carregamento, retire o cabo USB e feche a tampa.

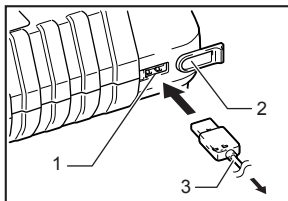

1. Porta de alimentação de corrente USB
2. Tampa
3. Cabo USB

## DANSK

**ADVARSEL: DENNE MASKINE KAN BRUGES AF BØRN PÅ 8 ÅR OG DEROVER OG AF PERSONER MED NEDSATTE FYSISKE, SENSORISKE ELLER MENTALE EVNER ELLER MANGLENDE ERFARING ELLER VIDEN, HVIS DE ER UNDER OPSYN ELLER HAR MODTAGET INSTRUKTION I SIKKER ANVENDELSE AF MASKINEN OG FORSTÅR DE FARER, DER ER INVOLVERET. BØRN MÅ IKKE LEGE MED MASKINEN. RENGØRING OG BRUGERVEDLIGEHOJDELSE MÅ IKKE UDFØRES AF BØRN, DER IKKE ER UNDER OPSYN.**

### Symboler

I det følgende vises de symboler, som anvendes til udstyret. Vær sikker på, at De har forstået symbolernes betydning, før udstyret anvendes.



- Kun til indendørs brug



- Læs brugsanvisningen.



- DOBBELT ISOLERET



- Klar til opladning



- Under opladning



- Opladning færdig



- Forsinket opladning (Akku-afkøling eller for kold akku)



- Defekt akku



- Konditionering



- Problem med afkøling.



- Kortslut aldrig Akku'ens poler. Brandfare!



- Bortskaf ikke batteriet ved at brande det.



- Udsæt ikke batteriet for vand eller regn.



- Aflever altid brugte akkuer til genbrug.



- Kun for EU-lande

Elektrisk udstyr og akkuer må ikke bortskaffes sammen med almindeligt husholdningsaffald!

I henhold til det europæiske direktiv om bortskaffelse af udtjente elektrisk og elektronisk udstyr og batterier og akkumulatører samt udtjente batterier og akkumulatører og udførelsen af dette i overensstemmelse med nationale love, skal elektrisk udstyr og batterier og akku(er), som er udtjente, indsamles separat og returneres til en miljømæssigt kompatibel genvindingsfacilitet.

1. GEM DISSE INSTRUKTIONER – Denne brugsanvisning indeholder vigtige sikkerheds- og betjeningsinstruktioner for akku-opladeren.
2. Læs, inden akku-opladeren tages i brug, alle instruktioner og forsigtighedsanvisninger på (1) akku-opladeren, (2) akkuen og (3) produkter, der betjener sig af akku.
3. FORSIGTIG – For at reducere risikoen for tilskadekomst, må man kun oplade genopladelige akkuer fra Makita. Andre typer akkuer kan eksplodere med tilskadekomst og beskadigelse som resultat.
4. Ikke-genopladelige akkuer kan ikke oplades med denne akku-oplader.

5. Anvend en strømkilde med den spænding, som er specificeret på opladerens fabriksskilt.
6. Oplad ikke akkuen på steder, hvor der er brændbar væske eller gasser.
7. Udsæt ikke opladeren for regn eller sne.
8. Bær aldrig opladeren i ledningen og tag den ikke ud af forbindelse ved at rykke i den.
9. Efter opladning eller inden vedligeholdelse eller rengøring, skal akkuen tages ud af forbindelse med strømkilden. Gør dette ved at trække i stikket og ikke i ledningen.
10. Sørg for, at ledningen er ført således, at man ikke træder på den, falder over den eller på anden måde udsætter den for beskadigelse eller pres.

- Anvend ikke opladeren med beskadiget ledning eller stik. Bed et autoriseret Makita-servicecenter om at udskifte dem for at undgå fare, hvis ledningen eller stikket er beskadiget.
- Undlad at anvende eller adskille opladeren, hvis den har været udsat for et hårdt slag, er blevet tabt eller på anden måde har lidt skade. Fejlagtig anvendelse eller samling kan resultere i risiko for elektrisk stød.
- Udskift ikke akkuen, hvis rumtemperaturen er UNDER 10°C eller OVER 40°C. Ved lave temperaturer er det ikke sikkert, at opladningen starter.
- Forsøg ikke at anvende en optransformer, en motorgenerator eller et DC strømstik.
- Sørg for, at der ikke er noget der dækker eller tilstopper opladerens ventilationsåbninger.
- Stik ikke søm, ståltråd eller lignende ind i USB-strømforsyningsporten.

### Opladning af MAKITA-akkuer

Denne oplader kan oplade to akkuer samtidigt.

- Sæt opladeren ind i et fungerende vekselstrømsudtag. Opladelyset vil blinke gentagne gange i grønt.
- Ret akkuen ind efter rillen i laderen og skub den helt ind. Dækslet over laderens terminaler åbner ved isætning af akkuen og lukker ved udtrækning af akkuen.
- Når akkuen er sat ind, vil det røde opladelys begynde at lyse, og opladningen vil begynde med en forindstillet, kort melodilyd, som er en bekræftelse af, hvilken lyd der vil blive afgivet som tilkendegivelse af, at opladningen er fuldført.
- Når opladningen er færdig, vil opladelyset skifte fra rødt til grønt, og melodilyden eller summetønelysten (et langt bip) lyder som tilkendegivelse af, at opladningen er færdig.
- Opladetiden varierer alt efter den temperatur (10°C – 40°C), hvorunder akkuen oplades, og tilstanden af akkuen, som for eksempel en akku, der er ny eller ikke har været anvendt i et længere tidsrum.
- Efter opladning skal akkuen tages ud af laderen, og laderen skal tages ud af forbindelse med strømudtaget.

### Ændring af melodien for fuldført opladning

- Sæt akkuen ind i den opladeport for hvilken du vil ændre melodien for fuldført opladning. Dette frembringer den sidste, forindstillede, korte melodi for fuldført opladning.
- Når akkuen tages ud eller sættes ind igen inden for fem sekunder efter denne handling, vil melodilyden blive ændret.
- Hver gang akkuen tages ud eller sættes ind inden for fem sekunder efter dette, vil melodilyden skifte i rækkefølge.
- Når den ønskede melodilyd lyder, skal man lade akkuen blive siddende, hvorefter opladningen begynder. Når en "kort bip"-indstilling vælges, vil der ikke lyde nogen signaler for fuldført opladning. (Lydløs indstilling).
- Når opladningen er fuldført, vil det grønne lys forblive tændt og det røde lys slukke, og den melodilyd, der blev forindstillet ved isætningen af akkuen, eller summetønelysten (et langt bip) vil lyde som tilkendegivelse af, at opladningen er færdig. (I den valgte lydøse indstilling, vil der ikke være nogen lyd.)
- Den forindstillede melodilyd bibeholdes i hukommelsen, selv efter at laderen er taget ud af forbindelse.

Spænding	9,6 V	12 V	14,4 V	Kapacitet (Ah)	Opladetid (minutter)
Antal celler	8	10	12		
Ni-MH-akku	BH9020A	—	—	2,0	20
	—	BH1220/C	BH1420	2,0	15
	BH9033A	—	—	3,3	30
	—	BH1233/C	BH1433	3,3	22

Spænding	14,4 V	18 V	14,4 V	18 V	Kapacitet (Ah) i henhold til IEC61960	Opladetid (minutter)
Antal celler	4	5	8	10		
Li-ion-akku	BL1415	BL1815	—	—	1,3	15
	—	—	BL1430/A	BL1830	3,0	22
	BL1415N/ BL1415NA	BL1815N	—	—	1,5	15
	—	BL1820/ BL1820B	—	—	2,0	24
	—	—	BL1440	BL1840/ BL1840B	4,0	36
	—	—	BL1450	BL1850/ BL1850B	5,0	45
	—	—	—	BL1860B	6,0	55

### BEMÆRK:

- Opladeren er til opladning af Makita akkuer. Anvend den aldrig til andre formål eller til akku af andet fabrikat.
- Når du oplader en akku, som er ny eller som ikke har været anvendt i længere tid, er det ikke sikkert, at en fuld opladning er mulig, før opladeren er helt afladet og opladet igen et par gange. (Kun Ni-MH-akku)
- Hvis opladelyset blinker rødt, betyder det, at akkuens tilstand er som vist herunder, og det er derfor ikke sikkert, at opladningen begynder.
  - En akku fra en netop anvendt maskine eller en akku, som har ligget et sted med direkte sol i et længere tidsrum.
  - En akku, som har ligget i længere tid på et sted, som er udsat for kold luft.
- Hvis akkuen er for varm, vil opladningen først begynde, når den er blevet kølet ned af ventilatoren i opladeren. Opladningen begynder, når akkuens temperatur har nået en grad, ved hvilken opladning er mulig.
- Hvis ladelampen skiftevis blinker grønt eller rødt, er opladning ikke mulig. Terminalerne på opladeren eller akkuen er tilstoppet med støv, eller akkuen er slidt op eller beskadiget.

### Kølesystem

- Denne oplader er forsynet med en ventilator til afkøling af akkuen, således at optimal ydelse sikres. Lyden fra køleluften høres under afkøling, hvilket ikke er tegn på, at der er noget i vejen med opladeren.
- Advsl lys blinker som advarsel i følgende tilfælde.
  - Problem med ventilatoren
  - Ufuldstændig afkøling af akkuen, eksempelvis hvis denne er tilstoppet med støv
- Akkuen kan oplades, selv om den gul advarslampe er tændt. Men ladetiden vil være længere end normalt.
- Lyt efter lyden af ventilatoren, og kontrollér ventilationshullerne på opladeren og akkuen, da disse kan tilstoppes af støv.
- Kølesystemet virker korrekt, selv om der ingen ventilatorlyd høres, såfremt den gule advarslampe ikke blinker.
- Hold altid ventilationshullerne på opladeren og akkuen rene for at fremme afkøling.
- Produkterne bør sendes til reparation eller eftersyn, hvis den gule advarslampe hyppigt blinker.

## Konditioneringsopladning

Konditioneringsopladning kan forlænge akkuens levetid, idet denne form for opladning automatisk bestemmer den optimale ladetilstand på akkuerne i enhver situation.

En akku, der gentagne gange anvendes under følgende forhold, kræver en "konditioneringsopladning" for ikke at blive hurtigt udtjent. I dette tilfælde lyser den gule lampe.

1. Opladning af akkuen, mens den er meget varm
2. Opladning af akkuen, mens den er meget kold
3. Opladning af en fuldt opladet akku
4. Overafloadning af akku (afloadning af akku fortsat selv om der ikke er mere strøm på)

Ladetiden er længere end normalt ved en sådan akku.

## Brug med USB-anordning

Denne oplader fungerer som en ekstern strømforsyning for USB-anordning.

1. Åbn USB-strømforsyningsportens dæksel. Slut USB-kablet til USB-strømforsyningsporten og USB-anordningen.
2. Sæt opladeren ind i en strømkilde.
3. Tag opladeren ud af forbindelse, når opladningen er færdig.

### Bemærk:

- Inden USB-anordningen sluttes til opladeren, skal du altid sørge for backup af USB-anordningens data. Ellers kan dine data gå tabt.
- Opladeren kan muligvis ikke strømforsyne visse USB-anordninger.
- Fjern USB-kablet og luk dækslet, når opladeren ikke bruges eller efter opladning.

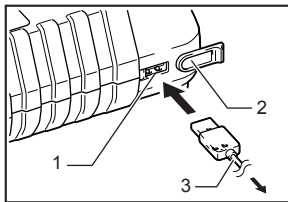

1. USB-strømforsyningsport
2. Dæksel
3. USB-kabel

## ΕΛΛΗΝΙΚΑ

**ΠΡΟΕΙΔΟΠΟΙΗΣΗ:** Η ΣΥΣΚΕΥΗ ΑΥΤΗ ΜΠΟΡΕΙ ΝΑ ΧΡΗΣΙΜΟΠΟΙΗΘΕΙ ΑΠΟ ΠΑΙΔΙΑ ΆΝΩ ΤΩΝ 8 ΕΤΩΝ ΚΑΙ ΆΤΟΜΑ ΜΕ ΜΕΙΩΜΈΝΕΣ ΣΩΜΑΤΙΚΈΣ, ΑΙΣΘΗΤΗΡΙΕΣ Ή ΔΙΑΝΟΗΤΙΚΈΣ ΙΚΑΝΟΤΗΤΕΣ Ή ΠΟΥ ΔΕΝ ΈΧΟΥΝ ΠΕΪΡΑ ΚΑΙ ΓΝΩΣΕΙΣ, ΕΑΝ ΕΠΙΤΗΡΟΥΝΤΑΙ Ή ΤΟΥΣ ΈΧΟΥΝ ΔΟΘΕΪ ΟΔΗΓΙΕΣ ΓΙΑ ΤΗΝ ΑΣΦΑΛΗ ΧΡΗΣΗ ΤΗΣ ΣΥΣΚΕΥΗΣ ΚΑΙ ΚΑΤΑΝΟΟΥΝ ΤΟΥΣ ΚΊΝΔΥΝΟΥΣ ΠΟΥ ΕΜΠΛΈΚΟΝΤΑΙ. ΤΑ ΠΑΙΔΙΑ ΔΕΝ ΠΡΈΠΕΙ ΝΑ ΠΑΙΖΟΥΝ ΜΕ ΤΗ ΣΥΣΚΕΥΗ. ΟΙ ΕΡΓΑΣΊΕΣ ΚΑΘΑΡΙΣΜΟΥ ΚΑΙ ΣΥΝΤΗΡΗΣΗΣ ΑΠΟ ΤΟ ΧΡΗΣΤΗ ΔΕΝ ΘΑ ΠΡΈΠΕΙ ΝΑ ΓΊΝΟΝΤΑΙ ΑΠΟ ΠΑΙΔΙΑ ΧΩΡΙΣ ΕΠΙΤΗΡΗΣΗ.

### Σύμβολα

Τα ακόλουθα δείχνουν τα σύμβολα που χρησιμοποιούνται για τον εξοπλισμό. Βεβαιωθείτε ότι καταλαβαίνετε τη σημασία τους πριν από τη χρήση.



- Αποκλειστική χρήση εντός κλειστών χώρων



- Διαβάστε τις οδηγίες χρήσης.



- ΔΙΠΛΗ ΜΟΝΩΣΗ



- Ετοιμο για φόρτιση



- Φόρτιση



- Φόρτιση ολοκληρώθηκε



- Καθυστερήση φόρτισης (Ψύξη μπαταρίας ή υπερβολικά ψυχρή μπαταρία)



- Ελαττωματική μπαταρία



- Κατάσταση



- Βλάβη ψύξης



- Μη βραχυκυκλώνετε τις μπαταρίες.



- Μη ρίχνετε τις μπαταρίες στη φωτιά.



- Μην εκθέτετε τις μπαταρίες στο νερό ή στη βροχή.



- Πάντοτε ανακυκλώνετε τις μπαταρίες.



- Μόνο για τις χώρες της ΕΕ

Μην απορρίπτετε τον ηλεκτρικό εξοπλισμό ή την μπαταρία μαζί με τα οικιακά απορρίμματα!

Σύμφωνα με τις Ευρωπαϊκές Οδηγίες για τον απόβλητο ηλεκτρικό και τον ηλεκτρονικό εξοπλισμό και τις μπαταρίες και συσσωρευτές και τις απόβλητες μπαταρίες και συσσωρευτές και την ενσωμάτωσή τους στην εθνική νομοθεσία, ο ηλεκτρικός εξοπλισμός και οι μπαταρίες που έχουν φτάσει στο τέλος ζωής τους πρέπει να συλλέγονται ξεχωριστά και να επιστρέφονται σε εγκαταστάσεις περιβαλλοντικής ανακύκλωσης.



- ΦΥΛΑΞΤΕ ΑΥΤΕΣ ΤΙΣ ΟΔΗΓΙΕΣ – Το παρόν εγχειρίδιο περιέχει σημαντικές οδηγίες χρήσεως και ασφαλείας για το φορτιστή μπαταρίας.
- Πριν από τη χρήση του φορτιστή μπαταρίας, διαβάστε όλες τις οδηγίες και τις σημειώσεις ασφαλείας πάνω (1) στο φορτιστή μπαταρίας, (2) στη μπαταρία και (3) στο προϊόν όπου χρησιμοποιείται η μπαταρία.
- ΠΡΟΣΟΧΗ – Για να μειωθεί ο κίνδυνος τραυματισμού, να φορτίσετε επαναφορτιζόμενες μπαταρίες τύπου Makita μόνο. Οι μπαταρίες άλλων τύπων ενδέχεται να υποστούν ρήξη και να προκαλέσουν τραυματισμό και υλικές ζημιές.
- Η φόρτιση μη επαναφορτιζόμενων μπαταριών με το συγκεκριμένο φορτιστή μπαταριών δεν είναι εφικτή.
- Να χρησιμοποιείτε παροχή ρεύματος ίδιας τάσης με την αναγραφόμενη τιμή στην πινακίδα προδιαγραφών του φορτιστή.
- Μην φορτίζετε την κασέτα μπαταρίας παρουσία εύφλεκτων υγρών ή αερίων.
- Δεν επιτρέπεται η έκθεση του φορτιστή σε βροχή ή χιόνι.
- Μην μεταφέρετε το φορτιστή κρατώντας τον από το καλώδιο ρεύματος, ούτε να τραβάτε το καλώδιο απότομα για να το αποσυνδέσετε από την πρίζα.
- Μετά το πέρας της φόρτισης ή πριν επιχειρήσετε οποιαδήποτε εργασία συντήρησης ή καθαρισμού, αποσυνδέστε το φορτιστή από την παροχή ρεύματος. Τραβήξτε το ρευματολήτη (φίς) και όχι το καλώδιο, κάθε φορά που αποσυνδέετε το φορτιστή.
- Φροντίστε ώστε το καλώδιο να βρίσκεται σε θέση, όπου δεν θα το πατήσετε, δεν θα σκονιάσετε πάνω του ούτε θα υποστείτε καταπόνηση ή ζημία.
- Μην θέσετε το φορτιστή σε λειτουργία αν το καλώδιο ή το φίς είναι καταστραμμένο. Αν το καλώδιο ή το φίς είναι καταστραμμένο, ζητήστε από ένα εξουσιοδοτημένο κέντρο σέρβις της Makita να το αντικαταστήσει ώστε να αποφευχθεί τυχόν κίνδυνος.
- Μην θέσετε το φορτιστή σε λειτουργία ούτε να τον αποσυναρμολογήσετε εάν έχει κτυπηθεί βίαια, έχει υποστεί πίεση ή οποιοδήποτε ζημιά. Φροντίστε για την προστασία του σε πιστοποιημένο τεχνικό σέρβις. Τυχόν εσφαλμένη χρήση ή εκ νέου συναρμολόγηση ενδέχεται να καταλήξει σε ηλεκτροπληξία ή πυρκαγιά.
- Μην φορτίζετε την κασέτα μπαταρία όταν η θερμοκρασία δωμάτιου είναι ΚΑΤΩ από 10°C ή ΠΑΝΩ από 40°C. Σε χαμηλές θερμοκρασίες, η φόρτιση μπορεί να μην ξεκινάει.
- Μην επιχειρήσετε να χρησιμοποιήσετε μετασχηματιστή πολλαπλασιασμού, γεννήτρια κινητήρα ή ρευματοδότη συνεχούς ρεύματος (DC).
- Μην καλύπτετε ή φράσσετε τις οπές εξαερισμού του φορτιστή, με κανένα αντικείμενο.
- Μην εισάγετε καρτί, σύρμα, κτλ. στη θύρα ηλεκτρικής παροχής USB.

### Φόρτιση για μπαταρίες MAKITA

Αυτός ο φορτιστής μπορεί να φορτίσει δύο μπαταρίες ταυτόχρονα.

- Συνδέστε τον φορτιστή σε κατάλληλη παροχή εναλλασσόμενου ρεύματος. Το λαμπάκι φόρτισης θα αναβοσβήνει με πράσινο χρώμα επαναληπτικά.
- Βάλτε την κασέτα μπαταρίας στο φορτιστή μέχρι να σταματήσει ρυθμιζόμενο από τον οδηγό του φορτιστή. Το κάλυμμα του τερματικού του φορτιστή μπορεί να ανοιχθεί με την εισαγωγή και να κλείσει με την απομάκρυνση της κασέτας μπαταρίας.
- Όταν εισαχθεί η κασέτα μπαταρίας το κόκκινο λαμπάκι φόρτισης θα ανάψει και η φόρτιση αρχίζει με τον προγραμματισμένο ήχο μίας σύντομης μελωδίας για επιβεβαίωση του ήχου που θα ακουστεί όταν ολοκληρωθεί η φόρτιση.
- Με το τέλος της φόρτισης, το λαμπάκι φόρτισης αλλάζει από κόκκινο σε πράσινο και ο ήχος μελωδίας ή ήχος βουβητή (ένα μακρύ μπιπ) ακούγεται για να δείξει την ολοκλήρωση της φόρτισης.
- Ο χρόνος φόρτισης διαφέρει ανάλογα με την θερμοκρασία (10°C – 40°C) στην οποία φορτίζεται η κασέτα μπαταρίας και ανάλογα με τις συνθήκες κασέτας μπαταρίας, καινούργια ή μακροχρόνια χρησιμοποιημένη.
- Μετά από τη φόρτιση, αφαιρέστε την κασέτα μπαταρίας από το φορτιστή και αποσυνδέστε το φορτιστή.

### Αλλαγή ήχου κατά την ολοκλήρωση της φόρτισης

- Εισαγάγετε την κασέτα μπαταρίας στη θύρα φόρτισης της οποίας θέλετε να αλλάξετε τον ήχο κατά την ολοκλήρωση της φόρτισης. Ανακαλεί τον τελευταίο προρυθμισμένο σύντομο ήχο για την ολοκλήρωση της φόρτισης.
- Αφαίρεση και επανεισαγωγή της κασέτας μπαταρίας μέσα σε πέντε δευτερόλεπτα μετά την πρώτη εισαγωγή, κάνει τον ήχο μελωδίας να αλλάξει.
- Κάθε φορά που αφαιρείτε και επανεισαγάγετε την κασέτα μπαταρίας ο ήχος μελωδίας αλλάζει κατά σειρά.
- Όταν ο επιθυμητός ήχος μελωδίας ακουστεί αφήστε την κασέτα μπαταρίας μέσα και η φόρτιση θα αρχίσει. Όταν επιλεγεί η θέση "βραχύ μπιπ" δεν ακούγονται τα σήματα ολοκλήρωσης της φόρτισης. (θέση αποσιώπησης)
- Με το τέλος της φόρτισης, το πράσινο λαμπάκι παραμένει αναμμένο, ενώ το κόκκινο σβήνει και ο προγραμματισμένος, κατά την εισαγωγή κασέτας μπαταρίας, ήχος μελωδίας ή ήχος βουβητή (μακρύ μπιπ) ακούγεται για επιβεβαίωση ολοκλήρωσης φόρτισης. (Στην θέση αποσιώπησης δεν ακούγεται ο ήχος.)
- Ο προγραμματισμένος ήχος μελωδίας παραμένει καταχωρημένος ακόμη και αν ο φορτιστής αποσυνδεθεί από το ρεύμα.

Τάση	9,6 V	12 V	14,4 V	Χωρητικότητα (Ah)	Χρόνος φόρτισης (Λεπτά)
Αριθμός Κυμελών	8	10	12		
Κασέτα μπαταρίας Ni-MH	BH9020A	—	—	2,0	20
	—	BH1220/C	BH1420	2,0	15
	BH9033A	—	—	3,3	30
	—	BH1233/C	BH1433	3,3	22

Τάση	14,4 V	18 V	14,4 V	18 V	Χωρητικότητα (Ah) σύμφωνα με IEC61960	Χρόνος φόρτισης (Λεπτά)
Αριθμός Κυμελών	4	5	8	10		
Κασέτα μπαταρίας Li-ion	BL1415	BL1815	—	—	1,3	15
	—	—	BL1430/A	BL1830	3,0	22
	BL1415N/ BL1415NA	BL1815N	—	—	1,5	15
	—	BL1820/ BL1820B	—	—	2,0	24
	—	—	BL1440	BL1840/ BL1840B	4,0	36
	—	—	BL1450	BL1850/ BL1850B	5,0	45
	—	—	—	BL1860B	6,0	55

## ΠΑΡΑΤΗΡΗΣΗ:

- Ο φορτιστής της μπαταρίας είναι για φόρτιση κασετών μπαταρίας Makita μόνο. Ποτέ μην τον χρησιμοποιείτε για άλλους σκοπούς ή για μπαταρίες άλλων κατασκευαστών.
- Όταν φορτίζετε μια κασέτα μπαταρίας που είναι νέα ή δεν έχει χρησιμοποιηθεί για πολύ καιρό, μπορεί να μη δέχεται πλήρη φόρτιση μέχρι να αποφορτιστεί εντελώς και να επαναφορτιστεί δύο φορές. (Μονό μπαταρίας Ni-MH)
- Εάν η λυχνία φόρτισης αναβοβλίνει σε κόκκινο, η κατάσταση της μπαταρίας είναι όπως υποδεικνύεται κατωτέρω και η φόρτιση ενδέχεται να μην αρχίσει.
  - Κασέτα μπαταρίας από εργαλείο που μόλις έχει χρησιμοποιηθεί ή κασέτα μπαταρίας που έχει μείνει σε θέση εκτεθειμένη σε άμεσο ηλιακό φως για μεγάλο χρονικό διάστημα.

## Σύστημα ψύξης

- Ο φορτιστής είναι εφοδιασμένος με ανεμιστήρα ψύξης για θερμοανάνεση μπαταρίας έτσι ώστε να καταστεί δυνατή η καλύτερη δυνατή απόδοση της μπαταρίας. Ο ήχος του αέρα ψύξης ακούγεται κατά τη διάρκεια της ψύξης, το οποίο σημαίνει ότι δεν υπάρχει πρόβλημα στον φορτιστή.
- Ένα κίτρινο φωτάκι θα ανάψει στις ακόλουθες περιπτώσεις.
  - Πρόβλημα στον ανεμιστήρα ψύξης
  - Ανεπαρκής ψύξη του ανεμιστήρα, όπως για παράδειγμα λόγω βουλωμάτος από σκόνη.Η μπαταρία μπορεί να φορτιστεί παρόλο που υπάρχει το προειδοποιητικό σήμα από το κίτρινο φωτάκι. Απλώς η φόρτιση θα διαρκέσει περισσότερο από το κανονικό σε αυτή την περίπτωση.

## Φόρτιση κατάστασης

Η φόρτιση κατάστασης μπορεί να επεκτείνει τη διάρκεια ζωής της μπαταρίας φάγοντας αυτόματα τη βέλτιστη κατάσταση φόρτισης για τις μπαταρίες σε κάθε περίπτωση. Η μπαταρία που χρησιμοποιείται στις ακόλουθες περιπτώσεις επανειλημμένα χρειάζεται "Φόρτιση κατάστασης" για να προληφθεί η γρήγορη φθορά της. Στην περίπτωση αυτή, θα ανάψει ένα κίτρινο προειδοποιητικό φωτάκι.

## Χρήση της συσκευής USB

Αυτό ο φορτιστής λειτουργεί ως εξωτερική ηλεκτρική παροχή για συσκευή USB.

1. Ανοίξτε το κάλυμμα της θύρας ηλεκτρικής παροχής USB. Συνδέστε το καλώδιο USB στη θύρα ηλεκτρικής παροχής USB και στη συσκευή USB.
2. Συνδέστε το φορτιστή σε ηλεκτρική παροχή.
3. Μετά τη φόρτιση, βγάλετε το φορτιστή από την πρίζα.

## Παρατήρηση:

- Πριν συνδέσετε συσκευή USB στο φορτιστή, να δημιουργείτε πάντα αντίγραφο ασφαλείας των δεδομένων στη συσκευή USB. Διαφορετικά, υπάρχει περίπτωση να χάσετε τα δεδομένα σας.
- Ο φορτιστής δεν θα παρέχει ισχύ σε μερικές συσκευές USB.
- Όταν δεν τον χρησιμοποιείτε ή μετά τη φόρτιση, αφαιρέστε το καλώδιο USB και κλείστε το κάλυμμα.

- Κασέτα μπαταρίας που έχει μείνει σε θέση εκτεθειμένη σε ψυχρό αέρα για μεγάλο χρονικό διάστημα. Όταν η κασέτα μπαταρίας είναι υπερβολικά θερμή, η φόρτιση θα αρχίσει μόλις η κασέτα μπαταρίας ψυχθεί από τον ανεμιστήρα ψύξης που είναι εγκατεστημένος στο φορτιστή. Η φόρτιση θα αρχίσει μόλις η θερμοκρασία της κασέτας μπαταρίας φθάσει στο επίπεδο που η φόρτιση είναι εφικτή.
- Εάν το φωτάκι φόρτισης ανάβει εναλλάσσόμενα σε χρώμα πράσινο και κόκκινο, η φόρτιση δεν είναι δυνατή. Τα τερματικά στον φορτιστή ή στην κασέτα μπαταρίας είναι βουλωμένα με σκόνη ή η κασέτα μπαταρίας είναι έχει φθαρεί ή καταστραφεί.

- Ελέγξτε τον ήχο του ανεμιστήρα ψύξης, τα ανοίγματα εξαερισμού στον φορτιστή και την μπαταρία, τα οποία μπορεί να έχουν βουλώσει με σκόνη.
- Το σύστημα ψύξης είναι εντάξει ακόμη και εάν δεν ακούγεται ο ήχος του ανεμιστήρα εξαερισμού, εάν το κίτρινο προειδοποιητικό φωτάκι δεν έχει ανάψει.
  - Πάντοτε να κρατάτε καθαρά τα ανοίγματα εξαερισμού στον φορτιστή και στην μπαταρία.
  - Τα προϊόντα θα πρέπει να στέλνονται για επισκευή ή συντήρηση, εάν το κίτρινο φωτάκι ανάβει συχνά.

1. Επαναφόρτιση της μπαταρίας σε υψηλή θερμοκρασία
  2. Επαναφόρτιση της μπαταρίας σε χαμηλή θερμοκρασία
  3. Επαναφόρτιση πλήρως φορτισμένης μπαταρίας
  4. Υπερφόρτιση της μπαταρίας (συνέχιση της αποφόρτισης της μπαταρίας και όχι μείωση της παροχής ενέργειας)
- Ο χρόνος φόρτισης μιας τέτοιας μπαταρίας είναι μεγαλύτερος από το κανονικό.

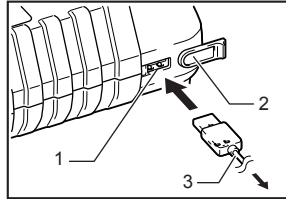

1. Θύρα ηλεκτρικής παροχής USB
2. Κάλυμμα
3. Καλώδιο USB

## TÜRKÇE

**UYARI: BU ALETİN 8 YAŞ VE ÜZERİ ÇOCUKLAR İLE FİZİKSEL, DUYUSAL YA DA ZİHİNSEL YETENEKLERİ KISITLI OLAN VEYA DENEYİM YA DA BİLGİLERİ OLMAYAN KİŞİLER TARAFINDAN KULLANILMASI, ANCAK GÖZETİM ALTINDA OLMALARI VEYA KENDİLERİNE ALETİN GÜVENLİ BİR ŞEKİLDE KULLANILMASINA YÖNELİK TALİMATLAR VERİLMESİ VE BU ALETİN KULLANIMINA İLİŞKİN TEHLİKELERİ ANLAMALARI HALİNDE MÜMKÜNDÜR. ÇOCUKLAR ALETLERİ OYNAMAMALIDIR. TEMİZLİK VE KULLANICI BAKIMLARI GÖZETİMSİZ OLARAK ÇOCUKLAR TARAFINDAN YAPILMAMALIDIR.**

## İşaretler

Aşağıdakiler bu donanım için kullanılan sembollerini göstermektedir. Kullanmadan önce manalarını anladığınızdan emin olunuz.



- Yalnız kapalı mekanlarda kullanım



- ÇİFT YALITIMLI



- Şarj ediyor



- Gecikmeli şarj (Pil soğuyor veya çok soğuk pil)



- Koşullama



- Pillerle kısa devre yaptırmayınız.



- Pili suya ya da yağmura maruz bırakmayın.



- Sadece AB ülkeleri için

Elektrik donanımını veya pil takımını evsel atıklarla birlikte bertaraf etmeyiniz!

Atık Elektrikli ve Elektronik Donanımlar, Piller ve Akümülatörler ve Atık Piller ve Akümülatörler konusundaki Avrupa Direktifleri ve bunların ulusal yasalara uygulanmaları uyarınca, kullanım ömürleri biten elektrikli donanımların, pillerin ve pil takım(lar)ının ayrı toplanmaları ve çevreye uyumlu bir geri kazanım tesisine getirilmeleri gereklidir.



- El kitabını okuyun.



- Şarja hazır



- Şarj sona erdi



- Kusurlu pil



- Soğutma anormalliği



- Pili yarakarak imha etmeyin.



- Pilleri her zaman yeniden çevrime sokunuz.

1. BU TALİMATLARI SAKLAYIN – Bu el kitabı pil şarj aleti için önemli güvenlik ve kullanma talimatları içermektedir.
2. Şarj aletini kullanmadan önce, tüm talimatları ve (1) pil şarj aleti, (2) pil ve (3) pili kullanan ürünün üstündeki tüm uyarıları okuyun.
3. DİKKAT – Yaralanma riskini azaltmak için sadece yeniden şarj edilebilir Makita tipi pilleri şarj edin. Başka tip piller patlayarak yaralanma ve hasara neden olabilir.
4. Tekrar şarj edilemeyen piller bu şarj aletiyle şarj edilemez.
5. Voltajı şarj aletinin isim plakasında belirtilen voltaja aynı olan bir güç kaynağı kullanın.
6. Pil kartuşunu kolay tutuşan sıvıların veya gazların olduğu yerlerde şarj etmeyin.
7. Şarj aletini yağmura ya da kara maruz bırakmayın.
8. Şarj aletini asla kablosundan tutarak taşımayın veya kablosundan çekerek prizden çıkarmayın.
9. Şarjdan sonra veya bakım ya da temizlik çalışması yapmadan önce, şarj aletinin fişini güç kaynağının prizinden çekin. Güç kaynağı bağlantısını keserken kablodan değil fişten çekin.
10. Kordonun üzerine basılmayacak, ayağa dolanmayacak ya da başka şekilde gerilip hasar görmeyecek bir konumda olduğundan emin olun.
11. Kablo veya fişi hasarlı olan şarj aletini çalıştırmayın. Kablo veya fiş hasarlıysa, tehlikeli bir durum oluşmasını önlemek için Makita yetkili servis merkezinden hasarlı parçanın değiştirilmesini isteyin.
12. Eğer sert bir darbe almış, yere düşürülmüş ya da başka türlü hasar görmüşse, şarj aletini kullanmayın veya sökmeyin. Yanlış kullanım veya montaj elektrik şoku ya da yangın riski doğurabilir.
13. Oda sıcaklığı 10°C'nin ALTINDA veya 40°C'nin ÜZERİNDE olduğunda pil kartuşunu şarj etmeyin. Soğuk havalarda şarj işlemi başlamayabilir.
14. Bir yükseltici transformator, motorlu jeneratör veya bir DC güç kaynağı prizi kullanmayı denemeyin.
15. Şarj cihazının deliklerinin tıkanmasına ya da üstlerinin örtülmesine izin vermemeyin.
16. USB güç kaynağı yuvasına çivi, tel gibi maddeler sokmayın.

## MAKITA pillerini şarj etme

Bu şarj aleti aynı anda iki pil şarj edebilir.

1. Şarj aletini uygun AC voltajına sahip bir prize takın. Şarj lambası yeşil renkte sürekli yanıp sönecektir.
2. Şarj aletinin kılavuzuna ayarlayarak pil kartuşunu şarj aletine sonuna kadar geçirin. Şarj aletinin terminal kapağı pil kartuşunu takarken açılabilir ve çıkarırken kapanabilir.
3. Pili kartuşu takıldığı zaman, kırmızı şarj lambası yanar ve önceden ayarlanan şarjın tamamlandığını bildirecek olan melodi kısaca çalınarak, şarj başlar.

## Şarj tamamlandı uyarısı melodisini değiştirme

1. Şarj tamamlandı uyarısı melodisini değiştirmek için pil kartuşunu şarj yuvasına takın. Şarj tamamlandı uyarısı için en son ayarlanan kısa melodi sesi çalınır.
2. Bu melodi çalındıktan sonraki beş saniye içinde kartuşun çıkarılıp, tekrar takılması çalınacak melodiyi değiştirir.
3. Bundan sonra kartuşun her defasında başka bir beş saniye içinde çıkarılıp, tekrar takılması çalınacak melodiyi sırayla değiştirir.
4. İstenilen melodi duyulunca, pil kartuşunu takılı olarak bırakırsanız, şarj başlar. Bir "kısa bip" kipi seçildiği zaman, tam şarj sinyali duyulmaz. (Sessiz Kipi)
5. Şarjın bitmesiyle, kırmızı ışık söner ve yeşil ışık yanmaya devam eder ve şarjın tamamlandığını bildirmek için pil kartuşu takıldığında önceden ayarlanan melodi veya uyarı sesi (uzun bir bip) duyulur. (Sessiz kipi seçildiğinde, herhangi bir ses duyulmaz.)
6. Şarj aleti prizden çekilmiş olsa bile önceden ayarlanan melodi bellekte saklı tutulur.

Voltaj	9,6 V	12 V	14,4 V	Kapasite (Ah)	Şarj süresi (dakika)
Hücre sayısı	8	10	12		
Ni-MH pil kartuşu	BH9020A	—	—	2,0	20
	—	BH1220/C	BH1420	2,0	15
	BH9033A	—	—	3,3	30
	—	BH1233/C	BH1433	3,3	22

Voltaj	14,4 V	18 V	14,4 V	18 V	IEC61960 uyarınca kapa- site (Ah)	Şarj süresi (dakika)
Hücre sayısı	4	5	8	10		
Li-ion pil kartuşu	BL1415	BL1815	—	—	1,3	15
	—	—	BL1430/A	BL1830	3,0	22
	BL1415N/ BL1415NA	BL1815N	—	—	1,5	15
	—	BL1820/ BL1820B	—	—	2,0	24
	—	—	BL1440	BL1840/ BL1840B	4,0	36
	—	—	BL1450	BL1850/ BL1850B	5,0	45
	—	—	—	BL1860B	6,0	55

#### NOT:

- Şarj cihazı, sadece Makita pil kartuşlarını şarj etmek içindir. Hiçbir zaman başka bir amaç için veya başka üreticilerin pilleri için kullanmayın.
- Yeni ya da uzun bir süre kullanılmamış bir pil kartuşunu şarj ederken, birkaç kez tamamen boşalıp yeniden şarj edilmedikçe tam şarj kabul etmeyebilir. (Sadece Ni-MH pil)
- Şarj lambası kırmızı renkte yanarsa pil durumu aşağıdaki gibidir ve şarj başlayamayabilir.
  - Yeni kullanılmış bir aletten çıkarılmış pil kartuşu veya uzun süre doğrudan güneş ışığına maruz kalan bir yerde kalmış pil kartuşu.

– Uzun süre soğuk havaya maruz kalan bir yerde bırakılmış pil kartuşu.

Pil kartuşu çok sıcak olduğunda, şarj pil kartuşu şarj aletine takılı soğutma fanı tarafından soğutulduktan sonra başlar. Şarj pil kartuşu sıcaklığının şarjin mümkün olduğu bir dereceye ulaşmasından sonra başlar.

- Şarj lambası sırayla yeşil ve kırmızı renklerde yanıp sönyorsa, şarj mümkün değildir. Şarj cihazının veya pil kartuşunun terminalleri tozla kaplanmış veya pil kartuşu eskimiş ya da hasar görmüş demektir.

#### Soğutma sistemi

- Bu şarj aletine ısınmış pillerin kendi performanslarını gösterebilmeleri için bir soğutma fanı takılmıştır. Soğutma sırasında soğutma havasının sesi duyulur ve bu şarj aletinde bir sorun olduğu anlamına gelmez.
- Aşağıdaki durumlarda sarı uyarı ışığı yanıp söner.
  - Soğutma fanındaki bir sorun
  - Tozla tıkanma gibi nedenlerle pilin tam soğutulmaması

Sarı uyarı ışığına rağmen pil şarj edilebilir. Ama bu durumda şarj süresi normalden uzun olacaktır. Soğutma fanının sesini, zaman zaman tozla tıkanabilen şarj cihazı ve pil üstündeki deliği kontrol edin.

- Eğer sarı uyarı ışığı yanmıyorsa, fandan ses gelmese bile soğutma sistemi çalışır durumdadır.
- Soğutma için pil ve şarj aleti üstündeki deliği daima temiz tutun.
- Eğer sarı uyarı ışığı sıkça yanıp sönmeye başlarsa ürünlerin bakım ya da onarım gönderilmesi gerekir.

#### Kondisyonlama şarjı

Kondisyonlama şarjı, her durumda piller için optimum şarj durumunu otomatik olarak bularak pil ömrünü uzatabilir. Tekrarlanan şekilde aşağıdaki koşullarda kullanılan pilin hızlı yıpranmasını önlemek için "kondisyonlama şarjı" gerekir. Bu durumda, sarı ışık yanar.

1. Pilin normal sıcaklığının üstünde şarj edilmesi
2. Pilin normal sıcaklığının altında şarj edilmesi
3. Tam şarjlı pilin yeniden şarj edilmesi
4. Pilin aşırı boşalması (gücünün çok azalmasına karşın pilin boşaltılmaya devam edilmesi.)

Bu durumdaki pillerin şarj süresi normalden uzundur.

#### USB aygıtı ile kullanma

- Bu şarj aleti, USB aygıtı için harici bir güç kaynağı olarak çalışır.
1. USB güç kaynağı yuvasının kapağını açın. USB kablounu USB güç kaynağına ve USB aygıtına bağlayın.
  2. Şarj aletinin fişini bir güç kaynağına takın.
  3. Şarj ettikten sonra şarj aletini prizden çıkarın.

#### Not:

- USB aygıtını şarj aletine bağlamadan önce USB aygıtınızdaki verileri her zaman yedekleyin. Aksi takdirde verilerinizin kaybolma ihtimali olabilir.
- Şarj aleti bazı USB aygıtlarını şarj edemeyebilir.
- Kullanmadığınız zamanlarda ya da şarj ettikten sonra, USB kablounu çıkarın ve kapağı kapatın.

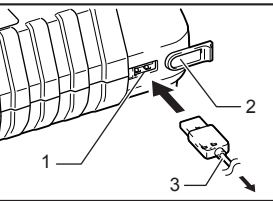















1. USB güç kaynağı yuvası
2. Kapaç
3. USB kablo

#### SVENSKA

**VARNING: DEN HÄR APPARATEN KAN ANVÄNDAS AV BARN FRÅN 8 ÅR OCH UPPÅT OCH PERSONER MED FYSISK ELLER PSYKISK FUNKTIONSNEDSÄTTNING ELLER NEDSATT SINNESFÖRMÅGA, ELLER SOM SAKNAR ERFARENHET OCH KUNSKAP, OM DE HAR FÅTT HANDLEDNING ELLER INSTRUKTIONER I HUR APPARATEN SKA ANVÄNDAS PÅ ETT SÄKERT SÄTT OCH ÄR INFÖRSTÅDDA MED RISKERNA DET INNEBÄR. BARN FÅR INTE LEKA MED APPARATEN. RENGÖRING OCH ANVÄNDARUNDERHÅLL FÅR INTE UTFÖRAS AV BARN UTAN UPPSIKT.**

## Symboler

Följande symboler används för utrustningen. Se noga till att du förstår deras innebörd innan utrustningen används.

-  • Får endast användas inomhus
-  • DUBBEL ISOLERING
-  • Laddning
-  • Fördröjd uppladdning (Batterikylning eller för kallt batteri)
-  • Tillståndsbedömning för villkorsladdning
-  • Försök aldrig att kortslua batterierna.
-  • Utsatt inte batteriet för vatten eller regn.
-  • Gäller endast EU-laddare  
Elektrisk utrustning får inte kastas i hushållssoporna!  
Enligt det europeiska direktivet om avfall som utgörs av elektrisk eller elektronisk utrustning och ackumulatörer samt förbrukade batterier och ackumulatörer och dess tillämpning enligt nationell lagstiftning ska uttjänt elektrisk utrustning och uttjänta batterier och batterikassetter sorteras separat och lämnas till miljövänlig återvinning.
-  • Läs bruksanvisningen.
-  • Färdig för laddning
-  • Laddningen avslutad
-  • Defekt batteri
-  • Problem med kylningen
-  • Försök inte att elda upp batteriet.
-  • Försök att lämna använda batterier till resursåtervinning (recycling).

1. SPARA DESSA ANVISNINGAR – Den här bruksanvisningen innehåller viktiga säkerhetsanvisningar och användningsinstruktioner för batteriladdaren.
2. Innan du använder batteriladdaren ska du läsa igenom alla anvisningar och all viktig information på (1) batteriladdaren, (2) batteriet och (3) produkten som använder batteriet.
3. FÖRSIKTIGHET – För att minska risken för skador bör du endast ladda uppladdningsbara batterier från Makita. Andra typer av batterier kan explodera och orsaka personskador eller andra skador.
4. Batterier som inte är uppladdningsbara kan inte laddas med den här batteriladdaren.
5. Använd en strömkälla med samma spänning som anges på laddarens etikett.
6. Ladda inte batterikassetten i närheten av lättantändlig vätska eller gas.
7. Utsätt inte laddaren för regn eller snö.
8. Bär aldrig laddaren i sladden och dra inte i sladden när du kopplar från laddaren från kontaktken.
9. Koppla från laddaren från strömkällan efter laddning eller innan du utför underhåll eller rengöring. Dra in kontakten och inte i sladden när du kopplar från laddaren.
10. Kontrollera att sladden är placerad så att ingen kan råka gå eller snubbla över den, eller att sladden på annat sätt kan utsättas för skador eller påfrestningar.
11. Använd inte laddaren med en skadad sladd eller kontakt. Om sladden eller kontakten är skadad ska du kontakta ett Makita- auktoriserat servicecenter för att byta ut det och på så sätt undvika risk för fara.
12. Använd inte och montera inte isär laddaren om den har utsatts för en kraftig stöt, tappats eller på något annat sätt skadats, utan ta den till en kvalificerad servicetekniker. Felaktig användning eller montering kan orsaka risk för elektriska stötar eller brand.
13. Ladda inte batterikassetten när rumstemperaturen är UNDER 10°C eller ÖVER 40°C. Laddningen kanske inte startas vid kalla temperaturer.
14. Använd inte tillsammans med en omvandlare/transformator, ett aggregat eller en likströmskontakt.
15. Låt ingenting täcka eller täppa igen laddarens ventiler.
16. Tryck inte in en spik, ståltråd eller liknande i USB-porten för strömförsörjning.

## Laddning av MAKITA-batterier

Den här laddaren kan ladda två batterier på samma gång.

1. Sätt i laddaren i ett eluttag med rätt spänning. Laddningslampan blinkar grönt.
2. Sätt i batterikassetten i laddaren tills det tar stopp, inriktad mot laddarens ledspår. Locket för laddarens kontaktbleck öppnas när i batterikassetten sätts i, och stängs när batterikassetten tas ur.
3. När batterikassetten sätts in tänds den röda laddningslampan och laddning startar med att den förinställda melodin spelas som även kommer att spelas när laddningen är klar.
4. När laddningen är klar släcks röd laddningslampan och grön tänds och melodin spelas eller så hörs en lång summerton.
5. Laddningstiden beror på vid vilken temperatur (10°C – 40°C) som batterikassetten laddas och om batterikassetten är ny eller inte har använts under en längre tid.
6. Efter uppladdning, tar du ut batterikassetten ur laddaren och kopplar ur laddaren.

## Ändra melodin som spelas när laddningen är klar

1. Sätt i batterikassetten i laddningsporten om du vill ändra melodin som spelas när laddningen är klar. Då spelas den senast inställda melodin som anger att laddningen är klar.
2. Om du då tar ut kassetten och sätter tillbaka den inom fem sekunder gör att melodin ändras.
3. Varje gång kassetten tas ut och sätts in inom fem sekunder spelas nästa laddningsmelodi.
4. När önskad melodi spelas låter du kassetten sitta kvar i laddaren så att laddningen startar. Om du väljer "kort ljudsignal" spelas ingen melodi när laddningen är klar. (Tyst läge)
5. När laddningen är klar lyser den gröna laddningslampan fortfarande medan den röda släcks och den melodi som valdes när kassetten sattes in spelas upp eller så hörs en lång summerton. (I tyst läge hörs ingenting.)
6. Förinställd melodi finns kvar i laddarens minne även när kontakten är utdragen.

Spänning	9,6 V	12 V	14,4 V	Kapacitet (Ah)	Laddningstid (minuter)
Antal celler	8	10	12		
Ni-MH batterikassetten	BH9020A	—	—	2,0	20
	—	BH1220/C	BH1420	2,0	15
	BH9033A	—	—	3,3	30
	—	BH1233/C	BH1433	3,3	22

Spänning	14,4 V	18 V	14,4 V	18 V	Kapacitet (Ah) enligt IEC61960	Laddningstid (minuter)
Antal celler	4	5	8	10		
Li-ion batterikasset	BL1415	BL1815	—	—	1,3	15
	—	—	BL1430/A	BL1830	3,0	22
	BL1415N/ BL1415NA	BL1815N	—	—	1,5	15
	—	BL1820/ BL1820B	—	—	2,0	24
	—	—	BL1440	BL1840/ BL1840B	4,0	36
	—	—	BL1450	BL1850/ BL1850B	5,0	45
	—	—	—	BL1860B	6,0	55

#### OBSERVERA!

- Batteriladdaren är avsedd för uppladdning av Makita batterikassetter. Använd den aldrig för andra ändamål, eller för uppladdning av batterier från andra tillverkare.
- Vid uppladdning av en ny batterikasset, eller en batterikasset som inte har använts under en längre tidsperiod, kan det inträffa att batterikassetten inte kan laddas upp helt; ladda ur batterikassetten helt och ladda upp den igen några gånger. (Endast Ni-MH batteriet)
- Om laddningslampan blinkar rött är batteriets tillstånd enligt nedan och laddningen kanske inte startar.
  - Batterikassetten kommer från ett verktyg som nyss har använts eller så har den legat på en plats som varit utsatt för direkt solljus under en längre tid.

– Batterikassetten har legat på en plats som varit utsatt för kall luft under en längre tid.

När batterikassetten är för varm, påbörjas laddningen först efter att batterikassetten har kylts ned av kylfläkten i laddaren. Laddningen påbörjas efter att batterikassetten har nått den temperatur där laddning är möjlig.

- Om laddningslamporna blinkar med omväxlande rött och grönt ljus, så går det inte att ladda batteriet. Kontaktblecken på laddaren eller batterikassetten är belagda med damm, eller så är batterikassetten utsliten eller skadad.

#### Kylsystem

- Laddaren är utrustad med en kylfläkt för varma batterier, i syfte att förbättra batteriets laddningsprestanda. Under kylning hörs det ett ljud från kylfläkten, men detta betyder inte att det är något fel på laddaren.
  - Ett gult ljus blinkar som varning i följande fall.
    - Problem med kylfläkten.
    - Batteriet är inte tillräckligt avsvolat, t. ex. på grund av att det är igensatt med damm.
- Batteriet kan laddas även om den gula varningslampan blinkar. Laddningstiden blir dock längre än normalt i dessa fall.

Lysna på ljudet från kylfläkten, och kontrollera ventilerna på laddaren och batteriet som ibland kan tappas igen med damm.

- Kylsystemet fungerar normalt, även om inget ljud hörs från fläkten, så länge den gula varningslampan inte blinkar.
- Se till att ventilerna på laddaren och batteriet alltid är rengjorda vid kylning.
- Produkten bör skickas på reparation eller underhåll, om den gula varningslampan ofta blinkar.

#### Villkorsladdning

Villkorsladdningen kan förlänga batteriernas livslängd, genom att automatiskt söka efter det optimala laddningsvillkoret för batteriet i varje enskilt fall.

Om batteriet används på följande sätt måste det ofta "villkorsladdning" för att inte ta slut så snabbt. Den gula lampan tänds i så fall.

- Uppladdning av varma batterier.
- Uppladdning av kalla batterier.
- Uppladdning av redan fullt uppladdade batterier.
- Överladdning av batterier (fortsatt användning av ett batteri som redan börjat ladda ur).

Laddningstiden för dessa typer av batterier är längre än normalt.

#### Användning tillsammans med en USB-enhet

Den här laddaren kan användas som en extern strömkälla för en USB-enhet.

- Öppna luckan till USB-porten för strömförsörjning. Anslut USB-kabeln till USB-porten för strömförsörjning och USB-enheten.
- Anslut laddaren till en strömkälla.
- Koppla från laddaren när laddningen är slutförd.

#### Observera!

- Säkerhetskopiera alltid dina data på USB-enheten innan du ansluter USB-enheten till laddaren. Annars finns det en risk att dina data går förlorade.
- Laddaren kanske inte kan ge ström åt vissa USB-enheter.
- Koppla från USB-kabeln och stäng luckan när den inte används eller efter laddning.

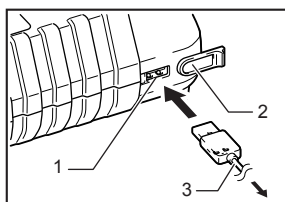

- USB-port för strömförsörjning
- Lucka
- USB-kabel

**ADVARSEL: DETTE APPARATET KAN BRUKES AV BARN FRA 8 ÅR OG OPPOVER SAMT PERSONER MED REDUSERTE FYSISKE, SANSEMESSIGE ELLER MENTALE FUNKSJONER ELLER MANGLENDE ERFARING OG KUNNSKAP DERSOM DE HAR TILSYN ELLER BLITT INSTRUERT I BRUKEN AV APPARATET PÅ EN TRYGG MÅTE, OG FORSTÅR FARENE DET INNEBÆRER. BARN SKAL IKKE LEKE MED APPARATET. RENGJØRING OG VEDLIKEHOLD SKAL IKKE UTFØRES AV BARN UTEN TILSYN.**

## Symbolene

Nedenfor ser du symbolene som brukes for dette utstyret. Det er viktig å forstå betydningen av disse før utstyret tas i bruk.



• Må bare brukes innendørs



• DOBBEL ISOLERING



• Lading



• Forsinket lading (Batteriet avkjøles, eller er for kaldt)



• Kondisjonering



• Gjør aldri forsøk på å kortslutte batteriene.



• Ikke la batteriet komme i kontakt med vann eller regn.



• Kun for EU-land

Ikke kast elektrisk utstyr eller batteri sammen med husholdningsavfall!

I henhold til EU-direktivet om avhending av elektrisk og elektronisk utstyr, batterier og akkumulatorer og avhending av batterier og akkumulatorer og disses implementasjon i henhold til nasjonal lovgivning, må elektrisk utstyr og batterier som har nådd slutten av sin levetid, samles inn separat og leveres til et miljøansvarlig resirkuleringsanlegg.



• Les bruksanvisningen.



• Klar til lading



• Lading fullført



• Defekt batteri



• Avkjølingsproblem



• Ikke utsett batteriet for ild.



• Brukte batterier bør resirkuleres, resursåtervinning.

- TA VARE PÅ DISSE INSTRUKSJONENE – Denne brukerveiledningen inneholder viktige instruksjoner vedrørende sikkerhet og drift av batteriladeren.
- Før du bruker batteriladeren, må du lese alle instruksjonene og varselsanvisningene på (1) batterilader, (2) batteri og (3) produktet som bruker batteriet.
- NB – For å redusere risiko for skade, må du kun lade oppladbare batterier av typen Makita. Andre typer batterier kan eksplodere, og forårsake personskade og annen ødeleggelse.
- Ikke-oppladbare batterier kan ikke lades med denne batteriladeren.
- Bruk en strømkilde med spenning som spesifisert på navneplaten til laderen.
- Ikke lade batteriet i nærheten av antennebærende væsker og gasser.
- Ikke utsett laderen for regn eller snø.
- Bær aldri laderen etter ledningen, og ikke rykk hardt i den for å frakoble den stikkkontakten.
- Etter lading eller før du går i gang med vedlikehold eller rengjøring, må kontakten til laderen trekkes ut av stikkkontakten. Dra i støpselet heller enn i ledningen når laderen frakobles.
- Sørg for at ledningen er plassert slik at den ikke vil bli tråkket på, snublet i eller på annen måte blir utsatt for skade eller strekk.
- Ikke bruk laderen med skadet ledning eller plugg. Hvis ledningen eller pluggen er skadet, må du be et autorisert Makita-servicesenter om å bytte den ut for å unngå fare.
- Ikke bruk laderen eller ta den fra hverandre hvis den har vært utsatt for et hardt slag, har falt ned eller er blitt skadet på annen måte. Ta den med til kvalifisert fagperson. Ukorrekt bruk eller demontering kan resultere i fare for elektrisk støt eller brann.
- Ikke lade batteriet når romtemperaturen er UNDER 10°C eller OVER 40°C. Ladingen vil kanskje ikke starte ved lave temperaturer.
- Ikke prøv å bruke en opptransformator, en maskingenerator eller en likestrømskontakt.
- Ikke la laderens ventilåpninger bli tildekket eller tilstoppet.
- Ikke sett inn en spiker, vaier e.l. i USB-strømporten.

## Lading for MAKITA-batterier

Denne laderen kan lade to batterier samtidig.

- Plugg laderen inn i riktig vekselstrømkilde. Ladelampen vil blinke grønt flere ganger.
- Sett batteriet inn i batteriladeren til det hviler på plass. Terminaldekslet på laderen åpnes ved innsetting av batteriet og lukkes når batteriet trekkes ut.
- Når batteriet settes inn, tennes den røde ladelampen, og ladingen begynner med en kort, forhåndsinnstilt melodi som også vil høres når ladingen er fullført.
- Når ladingen er fullført, vil ladelampen gå over fra å lyse rødt til å lyse grønt, og melodien eller summen (lang tone) markerer at ladingen er ferdig.
- Ladetiden varierer med temperaturen (10°C – 40°C) batteriet lades ved, og tilstanden til batteriet, f.eks. om batteriet er nytt eller ikke har vært i bruk på lenge.
- Etter lading må du ta batteriet ut av laderen og koble fra laderen.

## Endre melodi for fullført lading

1. Sett batteriet inn i ladeporten du vil endre melodi for, for fullført lading. Det vil hente den siste forhåndsvalgte korte melodien for fullført lading.
2. Hvis batteriet tas ut og settes inn igjen i løpet av fem sekunder, vil melodien skifte.
3. Hver gang batteriet tas ut og settes inn igjen i løpet av fem sekunder, skifter melodien i rekkefølge.
4. Når du kommer til den melodien du vil bruke, kan du bare la batteriet stå i laderen, og ladingen vil begynne. Når "kort tone" er valgt, vil fullført lading ikke bli signalisert. (Stille modus)
5. Når ladingen avsluttes, vil den grønne lampen forbli tent, den røde lampen slukkes, og den melodien som ble forhåndsinnstilt da batteriet ble satt inn, eller summerlyden (lang tone) signaliserer at ladingen er fullført. (Hvis stille modus er valgt, vil det ikke bli gitt noe akustisk signal.)
6. Den forhåndsinnstilte melodien forblir lagret, selv om laderen kobles fra strømforsyningen.

Spenning	9,6 V	12 V	14,4 V	Kapasitet (Ah)	Ladetid (minutter)
Antall elementer	8	10	12		
Ni-MH-batteri	BH9020A	—	—	2,0	20
	—	BH1220/C	BH1420	2,0	15
	BH9033A	—	—	3,3	30
	—	BH1233/C	BH1433	3,3	22

Spenning	14,4 V	18 V	14,4 V	18 V	Kapasitet (Ah) henhold til IEC61960	Ladetid (minutter)
Antall elementer	4	5	8	10		
Li-ion-batteri	BL1415	BL1815	—	—	1,3	15
	—	—	BL1430/A	BL1830	3,0	22
	BL1415N/ BL1415NA	BL1815N	—	—	1,5	15
	—	BL1820/ BL1820B	—	—	2,0	24
	—	—	BL1440	BL1840/ BL1840B	4,0	36
	—	—	BL1450	BL1850/ BL1850B	5,0	45
	—	—	—	BL1860B	6,0	55

### MERKNAD:

- Batteriladeren er beregnet til opplading av Makita-batteri. Må ikke brukes til andre formål eller til lading av batterier fra andre produsenter.
- Når du lader et nytt batteri eller et batteri som ikke har vært i bruk på lenge, vil det kanskje ikke ta i mot full lading før det har vært helt utladet og ladet opp igjen noen ganger. (Kun Ni-MH-batterier)
- Hvis ladelampen blinker rødt, er batteriets tilstand som beskrevet nedenfor, og ladingen kommer derfor kanskje ikke i gang.

### Kjølesystem

- Denne laderen er utstyrt med en kjølevifte for varme batterier, slik at batteriet likevel kan lades opp. Viften vil høres under avkjøling og dette er tegn på at laderen virker som den skal.
- En gul varselampe vil blinke i følgende tilfeller.
  - Når det er problemer med kjøleviften.
  - Når batteriet er utilstrekkelig avkjølt fordi lader eller batteri er tilstoppet med støv.Batteriet kan lades opp selv om den gule varselampen lyser, men ladetiden vil være lenger enn vanlig.

### Kondisjoneringslading

Kondisjoneringslading kan forlenge batteriets levetid ved automatisk å lete etter batteriets optimale ladetilstand uansett forhold. Under de betingelsene som er beskrevet nedenfor, trenger batteriet "kondisjoneringslading" for ikke å utlades raskt. I så fall vil den gule varselampen tennes.

### Bruke med USB-enhet

Denne laderen fungerer som en ekstern strømforsyning for USB-enhet.

1. Åpne dekslet til USB-strømporten. Koble USB-kabelen til USB-strømporten og USB-enheten.
2. Plugg laderen til en strømkilde.
3. Plugg fra laderen etter lading.

### Merknad:

- Du bør alltid sikkerhetskopiere dataene på USB-enheten før du kobler USB-enheten til laderen. Ellers kan det hende at dataene går tapt.
- Laderen vil kanskje ikke tilføre strøm til enkelte USB-enheter.
- Når den ikke er i bruk eller etter lading, må USB-kabelen fjernes og dekslet lukkes.

- Batteriet kommer fra en maskin som akkurat har vært i bruk, eller batteriet har vært utsatt for direkte sollys over lengre tid.
- Batteriet har vært utsatt for lave temperaturer over lengre tid. Når batteriet er for varmt, vil ladingen begynne etter at kjøleviften i laderen har avkjølt det. Ladingen vil begynne når batteritemperaturen har nådd et nivå der lading er mulig.
- Hvis ladelampen blinker vekselvis i rødt og grønt, er lading ikke mulig. Terminalene på batteriet eller laderen kan være tilstoppet av støv eller så er batteriet utgått eller skadet.

- Kontroller lyden som kommer fra kjøleviften, samt ventilene på laderen og batteriet da disse kan stoppes til av støv.
- Kjølesystemet er i orden selv om det ikke høres noen lyd fra kjøleviften, såfremt den gule varselampen ikke blinker.
  - Ventil på lader og batteriet må alltid holdes rene.
  - Laderen må sendes inn til vedlikehold og reparasjon hvis den gule varselampen blinker ofte.

1. Opplading når batteriet er veldig varmt.
  2. Opplading når batteriet er nedkjølt.
  3. Opplading når batteriet er fullt oppladet.
  4. Overutlading av batteriet (fortsatt bruk på tross av nedsatt effekt).
- Ladetiden for ovennevnte batterier vil være lenger enn normalt.

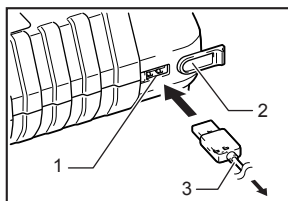





1. USB-strømport
2. Deksel
3. USB-kabel



**VAROITUS: LAITETTA SAAVAT KÄYTTÄÄ YLI 8-VUOTIAAT LAPSET JA HENKILÖT, JOIDEN FYYSINEN, AISTIENVARAINEN TAI HENKINEN TOIMINTAKYKY ON RAJOITTUNUT TAI JOILLA EI OLE TARVITTAVAA KOKEMUSTA TAI TIETOA, JOS HEITÄ VALVOTAAN TAI OPASTETAAN LAITTEEN TURVALLISEEN KÄYTTÖÖN, JA HE YMMÄRTÄVÄT KÄYTTÖÖN LIITTYVÄT VAARAT. LAPSET EIVÄT SAA LEIKKIÄ LAITTEELLA. LAPSET EIVÄT SAA TEHDÄ PUHDISTUS- TAI KUNNOSSAPITOTOIMENPITEITÄ ILMAN VALVONTAA.**

**Symbolit**

Alla on esitetty laitteessa käytettävät symbolit. Opettele näiden merkitys, ennen kuin käytät laitetta.

-  • Saadaan käyttöä ainoastaan sisätiloissa
-  • KAKSINKERTAINEN ERISTYSTY
-  • Lataaminen
-  • Viiveltäminen (Akun jäähdytys tai liian kylmä akku)
-  • Säätölataus
-  • Älä yritä oikosulkea akkuja.
-  • Pidä akku poissa vedestä ja sateesta.
-  • Koskee vain EU-maita
-  • Katso käyttöohjeita.
-  • Valmis lataamaan
-  • Lataus on valmis
-  • Viallinen akku
-  • Ongelma jäähdytyksessä
-  • Älä hävitä akkuja tulella.
-  • Yritä kierrättää käytetyt akut.

Älä hävitä sähkölaitteita tai akkuja tavallisen kotitalousjätteen mukana!  
 Vanhoja sähkö- ja elektroniikkalaitteita ja paristoja ja akkuja koskevan EU-direktiivin sekä käytettyjä paristoja ja akkuja koskevan direktiivin ja niiden maakohtaisten sovellusten mukaisesti käytetyt sähkölaitteet sekä paristot ja akut on toimitettava ongelmajätteiden keräyspisteeseen ja ohjattava ympäristöstävälliseen kierrätykseen.

1. SÄILYTÄ NÄMÄ OHJEET – Tämä opas sisältää tärkeitä akkutiluria koskevia turvallisuus- ja käyttöohjeita.
2. Ennen akkulaturin käyttöönottoa tutustu kaikkiin laturissa (1), akussa (2) ja akkukäyttöisessä tuotteessa (3) oleviin varoitusteksteihin.
3. VARO – Loukkaantumisaarua vähentämiseksi lataa vain Makita-tyyppisiä ladattavia akkuja. Muun tyyppiset akut voivat rikkoutua ja aiheuttaa henkilövahinkoja ja vaurioita.
4. Tällä akkulaturilla ei voi ladata ei-ladattavia paristoja.
5. Käytä virtalähdettä, jonka jännite on sama kuin laturin tyyppivälissä ilmoitettu.
6. Älä lataa akkuja tiloissa, joissa on tulenarkoja nesteitä tai kaasuja.
7. Älä aseta laturia alttiiksi vedelle tai lumelle.
8. Älä koskaan kanna laturia johdosta aläkä koskaan vedä johdosta irrottaessasi sitä pistorasiasta.
9. Irrota laturi virtalähteestä latauksen jälkeen tai ennen huoltotoimenpiteitä tai puhdistamista. Vedä pistotulpasta, älä johdosta, kun irrotat laturia.
10. Varmista, että johto on sijoitettu niin, ettei sen päälle astuta, ettei siihen kompastuta tai ettei siihen muuten kohdistu vaurioita tai rasitusta.
11. Älä käytä laturia, jos sen johto tai pistotulppa on vaurioitunut. Jos johto tai pistotulppa on vaurioitunut, pyydä vaaran välttämiseksi valtuutettua Makita-huoltokeskusta vaihtamaan se.
12. Älä käytä tai pura laturia, jos siihen on osunut terävä isku tai jos se on pudonnut tai muutoin vaurioitunut jollain tavalla. Virheellinen käyttö tai kokoaminen voi aiheuttaa sähköiskun tai tulipalon vaaran.
13. Älä lataa akkuja, kun huonelämpötila on ALLE 10°C tai YLI 40°C. Kylmässä lämpötilassa lataus ei välttämättä käynnisty.
14. Älä käytä jänniteennoostomuuntajaa, moottorigeneraattoria tai DC-virtapistoketta.
15. Älä anna minkään peittää tai tukkia laturin ilma-aukkoja.
16. Älä työnnä nauloja, rautalankaa jne. USB-virtaporttiin.

**MAKITA-akkujen lataaminen**

Tässä laturissa voidaan ladata kaksi akkuja samanaikaisesti.

1. Liitä laturi sopivaan vaihtovirtalähteeseen. Latausvalo vilkkuu toistuvasti vihreänä.
2. Työnä akku lataaja, kunnes se pysähtyy lataajan ohjaimen. Lataajan liittimen suojus aukeaa työnnettäessä akku sisään ja sulkeutuu vedettäessä akku irti.
3. Kun akku asetetaan paikalleen, punainen latausvalo syttyä ja latauksen alussa kuuluu lyhyt ennalta määrätty sävelmä muistuttamaan, millainen ääni tulee kuulumaan merkiksi latauksen päättymisestä.
4. Kun lataus on valmis, latausvalo vaihtuu punaisesta vihreäksi ja sävelmä tai sumeri (pitkä piippaus) kuuluu merkiksi latauksen päättymisestä.
5. Latausaika vaihtelee sen mukaan, missä lämpötilassa (10°C – 40°C) akku ladataan ja mikä on akun kunto eli esimerkiksi akku on uusi tai akku ei ole käytetty pitkään aikaan.
6. Lataamisen jälkeen irrota akku lataajasta ja lataaja virtalähteestä.

## Valmiin latauksen sävelmän vaihtaminen

1. Aseta akku latausporttiin, jonka valmiin latauksen sävelmän haluat vaihtaa. Silloin kuuluu viimeksi käytetty lyhyt valmiin latauksen sävelmä.
2. Jos akku irrotetaan ja asetetaan takaisin paikalleen viiden sekunnin kuluessa, sävelmä vaihtuu.
3. Joka kerta kun akku irrotetaan ja laitetaan takaisin paikalleen viiden sekunnin aikana, sävelmä vaihtuu järjestyksessä.
4. Kun kuulet haluamasi sävelmän, jätä akku paikalleen, jolloin lataus alkaa. Jos valitset "lyhyen piippauksen", latauksesta kertovaa ääntä ei kuulu. (Äänetön tila)
5. Kun lataus on päättynyt, vihreä valo palaa ja punainen valo sammuu ja akku paikalleen asettaessa kuulunut sävelmä tai sumერი (pitkä piippaus) kuuluu sen merkiksi, että lataus on päättynyt. (Ääntä ei kuulu, jos on valittu äänetön tila.)
6. Valitut sävelmän asetukset säilyvät, vaikka laturi irrotetaan pistorasiasta.

Jännite	9,6 V	12 V	14,4 V	Kapasiteetti (Ah)	Latausaika (minuuttia)
Kennojen lukumäärä	8	10	12		
Ni-MH-akku	BH9020A	—	—	2,0	20
	—	BH1220/C	BH1420	2,0	15
	BH9033A	—	—	3,3	30
	—	BH1233/C	BH1433	3,3	22

Jännite	14,4 V	18 V	14,4 V	18 V	Kapasiteetti (Ah) mukaan IEC61960	Latausaika (minuuttia)
Kennojen lukumäärä	4	5	8	10		
Li-ion-akku	BL1415	BL1815	—	—	1,3	15
	—	—	BL1430/A	BL1830	3,0	22
	BL1415N/ BL1415NA	BL1815N	—	—	1,5	15
	—	BL1820/ BL1820B	—	—	2,0	24
	—	—	BL1440	BL1840/ BL1840B	4,0	36
	—	—	BL1450	BL1850/ BL1850B	5,0	45
	—	—	—	BL1860B	6,0	55

## HUOMAUTUS:

- Akkulataaja on tarkoitettu Makitan akkujen lataamiseen. Älä koskaan käytä sitä muihin tarkoituksiin äläkä muiden akkujen lataamiseen.
- Kun lataat uutta akkua tai pitkään käyttämättömänä ollut akkua, se ei ehkä vastaanota täyttä latausta ennen kuin sen lataus on purettu kokonaan ja se on ladattu muutamia kertoja. (Pelkkä Ni-MH-akku)
- Jos latausvalo vilkkuu punaisena, akun tila on alla kerrotun kaltainen ja lataus ei ehkä käynnisty.
- Akulla on juuri käytetty konetta tai akkua on pidetty suorassa auringonvalossa pitkän aikaa.
- Akkua on pidetty kylmässä pitkän aikaa. Kun akku on liian kuumaa, lataus alkaa vasta kun lataaja asennettu jäädytystuuletin on jäädyttänyt sen. Lataus alkaa sen jälkeen, kun akun lämpötila saavuttaa lämpötilan, jossa lataus on mahdollinen.
- Jos latausvalo vilkkuu vuorotellen vihreänä ja punaisena, lataaminen ei ole mahdollista. Lataajan tai akun liittimet ovat pölyn peitossa tai akku on kulunut loppuun tai vioittunut.

## Jäähdytysjärjestelmä

- Tämä lataaja on varustettu kuuman akun tuulettimella, jotta akun suorituskykyä saadaan parannettua. Jäähdytyksen aikana kuuluva jäähdytysilman ääni ei ole oire lataajan viasta.
- Keltainen valo vilkkuu varoituksena seuraavissa tilanteissa.
  - Tuulettinongelma
  - Akku ei jäähy riittävästi johtuen esimerkiksi pölyn aiheuttamasta tukoksesta.
- Akku voidaan ladata keltaisesta varoitusvalosta huolimatta. Latausaika on tällöin kuitenkin tavanomaista pidempi. Tarkasta tuulettimen ääni sekä lataajan ja akun ilma-aukko, jotka voivat toisinaan tukkeutua pölystä.
- Jäähdytysjärjestelmä on kunnossa, vaikka tuulettimen ääntä ei kuulu silloin, kun keltainen varoitusvalo ei vilku.
- Pidä lataajan ja akun jäähdytystä varten oleva ilma-aukot aina puhtaina.
- Laitteet tulee lähettää korjattaviksi tai huoltoon, jos keltainen varoitusvalo vilkkuu usein.

## Säätölataus

Säätölataus pidentää akun käyttöikää valitsemalla automaattisesti akulle kussakin tilanteessa sopivimmat latausolot. Seuraavissa oloissa käytettävä akku tarvitsee toistuvasti "säätölataus", jotta se ei kuluisi nopeasti loppuun. Keltainen valo syttyy tällöin.

1. Akku ladataan kuumana.

## Käyttäminen USB-laitteen kanssa

Tämä laturi toimii ulkoisena virtalähteenä USB-laitteelle.

1. Avaa USB-virtaportin suojus. Yhdistä USB-kaapeli USB-virtalähteeseen ja USB-laitteeseen.
2. Yhdistä laturi virtalähteeseen.
3. Irrota laturi lataamisen jälkeen.

## Huomautus:

- Tee USB-laitteen tiedoista aina varmuuskopio ennen USB-laitteen yhdistämistä laturiin. Muutoin on mahdollista, että tiedot häviävät.
- Laturi ei välittämättä syötä virtaa joihinkin USB-laitteisiin.
- Irrota USB-kaapeli ja sulje suojus, kun lopetat käytön tai lataamisen jälkeen.

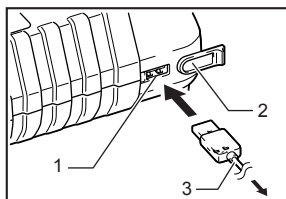

1. USB-virtaportti
2. Suojus
3. USB-kaapeli

## BRĪDINĀJUMS! ŠO IERĪCI VAR EKSPLUATĒT BĒRNI VECUMĀ NO 8 GADIEM UN PERSONAS, KAM IR IEROBEŽOTAS FIZISKĀS, SENSORĀS VAI PSIHISKĀS SPĒJAS VAI TRŪKST PIEREDZES UN ZINĀŠANU, JA ŠĪS PERSONAS VAI BĒRNI TIEK UZRAUDZĪTI VAI APMĀCĪTI IERĪCES DROŠĀ LIETOŠANĀ UN JA VIŅI IZPROT VISUS RISKUS SAISTĪBĀ AR TO. NEDRĪKST ĻAUT BĒRNIEM SPĒLĒTIES AR IERĪCI. BĒRNI DRĪKST TĪRĪT IERĪCI UN VEIKT TAI APKOPI TIKAI PIEAUGUŠO UZRAUDZĪBĀ.

### Simboli

Zemāk ir attēloti simboli, kas attiecas uz iekārtu. Pirms darbarīka izmantošanas pārliecinieties, vai pareizi izprotat to nozīmi.



- Lietošanai tikai telpās



- DUBULTA IZOLĀCIJA



- Notiek uzlāde



- Uzlādes atlikšana (akumulatora dzesēšana vai pārāk auksts akumulators)



- Kondicionēšana



- Neradiet īssavienojumu akumulatorā



- Nepakļaujiet akumulatoru ūdens vai lietus ietekmei.



- Tikai ES valstīm

Neizmetiet elektriskās iekārtas un akumulatoru sadzīves atkritumos!

Ievērojiet Eiropas Direktīvu par elektrisko un elektronisko iekārtu atkritumiem un Direktīvu par baterijām un akumulatoriem, un bateriju un akumulatoru atkritumiem, kā arī īstenojot abas direktīvas saskaņā ar valsts tiesību aktiem, elektriskās iekārtas, baterijas un akumulatori, kam beidzies ekspluatācijas laiks, jāsvāc atsevišķi un jānodod videi nekaitīgā pārstrādes iekārtā.



- Izlasiet lietošanas rokasgrāmatu.



- Gatavs uzlādei



- Uzlāde pabeigta



- Bojāts akumulators



- Traucēta dzesēšana



- Nemetiet akumulatoru ugunī.



- Vienmēr nododiet akumulatorus atkārtotai pārstrādei.



- Ni-MH  
Li-Ion

- SAGLABĀJIET ŠOS NOTEIKUMUS – Šajā rokasgrāmatā ir iekļauti svarīgi drošības un ekspluatācijas noteikumi akumulatora lādētājam.
- Pirms lādētāja izmantošanas izlasiet visus norādījumus un brīdinājuma apzīmējumus uz (1) akumulatora lādētāja, (2) akumulatora un (3) ierīces, kurā tiek izmantots akumulators.
- UZMANĪBU! – Lai ievainojumu risks būtu mazāks, uzlādējiet tikai Makita vairākkārt uzlādējamus akumulatorus. Cita veida akumulatori var eksplodēt, izraisot ievainojumus un sabojājot ierīci.
- Ar šo lādētāju nevar uzlādēt vienreiz uzlādējamus akumulatorus.
- Elektrobarošanas avota spriegumam jāatbilst tam, kāds norādīts lādētāja plāksnītē.
- Neuzlādējiet akumulatoru viegli uzliesmojošu šķidrumu vai gāzu tuvumā.
- Nepakļaujiet lādētāju lietus vai sniega iedarbībai.
- Nekad nepārnēsājiet instrumentu, turot aiz vada, vai neraujiet vadu, lai atvienotu no kontaktligzdas.
- Atvienojiet lādētāju no elektrobarošanas avota tad, kad tas ir uzlādēts vai ja grasāties tam veikt apkopi vai tīrīšanu. Lai to atvienotu, neraujiet aiz vada, bet gan aiz kontaktdakšas.
- Pārbaudiet, vai vads ir novietots tā, lai uz tā neuzkāptu, pār to nepakļūptu vai citādi nesabojātu vai nesarautu.
- Nelietojiet lādētāju, ja tā vads vai kontaktdakša ir bojāta. Ja vads vai kontaktdakša ir bojāta, lūdziet Makita pilnvarotā apkopes centrā to nomainīt, lai nepieļautu apdraudējumu.
- Neekspluatējiet vai neizjauciet lādētāju, ja tas ir saņēmis asu triecienu, ticis nomests vai citādi ir bojāts; nogādājiet to kvalificētam remontmeistaram. Ja tas tiek nepareizi ekspluatēts vai no jauna samontēts, var rasties elektriskās strāvas triecienu vai aizdegšanās risks.
- Nelādējiet akumulatoru, ja temperatūra telpā ir ZEMĀKA PAR 10°C vai AUGSTĀKA PAR 40°C. Zemā temperatūrā uzlāde var nesākties.
- Neizmantojiet paugstināšu transformatoru, dzinēja generatoru vai līdzstrāvas kontaktligzdu.
- Lādētāja vēdināšanas atveres nedrīkst būt nosegtas vai nosprostotas.
- USB barošanas pieslēgvietā nedrīkst ievietot naglas, stieples u.c.

### MAKITA akumulatoru uzlādēšanai

Ar šo lādētāju var vienlaicīgi uzlādēt divus akumulatorus.

- Pievienojiet lādētāju piemērotā maiņstrāvas sprieguma avotam. Uzlādes gaisma tūdaļ iemīgsiesies zaļā krāsā.
- Ievietojiet akumulatoru lādētājā, līdz tas pilnībā iegujas vadītājas gala stāvoklī. Lādētāja kontaktu vāku var atvērt un aizvērt, iespējams izvēlot akumulatoru.
- Kad akumulators ir ievietots, iedegiesies sarkanā akumulatora uzlādes gaisma un uzlāde sākas ar iepriekš iestatītu tsu, melodijas skaņu; lai informētu par skaņu, kas tiks izdota, kad uzlāde beigsies.
- Uzlādes beigās, akumulatora uzlādes gaisma nomainīsies no sarkanās uz zaļu un noskanēs melodijas skaņa vai svilpiens (garš pikstiens), lai informētu par uzlādes beigām.
- Uzlādes laiks mainās atkarībā no temperatūras (10°C – 40°C), kurā akumulators tiek uzlādēts un akumulatora stāvokļa, piemēram, ja akumulators ir jauns vai nav izmantots ilgāku laika periodu.
- Pēc uzlādes veikšanas izņemiet akumulatoru no uzlādes ierīces un atvienojiet uzlādes ierīci no elektrības avota.

## Melodijas maiņa pabeigta uzlādei

1. Ievietojiet akumulatoru tajā uzlādēšanas ligzdā, kurai vēlaties nomainīt skaņas signāla melodiju, kas atskan, pabeidzot uzlādi. Īsi atskan pēdējā iestatītā skaņas signāla melodija pabeigta uzlādei.
2. Izņemot un otrreiz ievietojot akumulatoru ar piecu sekunžu intervālu, tiks veikta melodijas skaņas maiņa.
3. Katru reizi izņemot un pēc piecām sekundēm atkal ievietojot akumulatoru, melodijas skaņa mainās secīgā kārtībā.
4. Kad atskan vēlāmā melodijas skaņa, atstājiet akumulatoru ievietotu un sāksies uzlāde. Ja tiek izvērlēts "Īsa pīkstiena" režīms, tad pie pabeigtas uzlādes signāls neatskan. (Klusais režīms)
5. Pēc uzlādēšanās zaļā gaisma paliek degot, bet sarkanā izdziest un atskan pie akumulatora ievietošanas iestatītā melodija vai svilpiens (garš pīkstiens), lai informētu par uzlādes beigām. (Izvērlētajā klusajā režīmā signāls neatskan.)
6. Iestatītā melodijas skaņa saglabājas pat tad, kad lādētājs ir atslēgts.

Spriegums	9,6 V	12 V	14,4 V	Tipums (ampēri stundā)	Uzlādēšanas laiks (minūtes)
Elementu skaits	8	10	12		
Niķeļa-metāla hidrīda akumulators	BH9020A	—	—	2,0	20
	—	BH1220/C	BH1420	2,0	15
	BH9033A	—	—	3,3	30
	—	BH1233/C	BH1433	3,3	22

Spriegums	14,4 V	18 V	14,4 V	18 V	Tipums (ampēri stundā) saskaņā ar IEC61960	Uzlādēšanas laiks (minūtes)
Elementu skaits	4	5	8	10		
Litija jonu akumulators	BL1415	BL1815	—	—	1,3	15
	—	—	BL1430/A	BL1830	3,0	22
	BL1415N/ BL1415NA	BL1815N	—	—	1,5	15
	—	BL1820/ BL1820B	—	—	2,0	24
	—	—	BL1440	BL1840/ BL1840B	4,0	36
	—	—	BL1450	BL1850/ BL1850B	5,0	45
	—	—	—	BL1860B	6,0	55

### PIEZĪME:

- Akumulatora lādētājs ir paredzēts Makita akumulatora lādēšanai. Nekādā gadījumā neizmantojiet to citiem nolūkiem vai citu ražotāju akumulatoru lādēšanai.
- Lādējot jaunu akumulatoru vai akumulatoru, kas ilgu laiku nav lietots, tas var pilnībā neuzlādēties, iekams nav pilnībā izlādēts un tad pāris reizes uzlādēts (tikai Ni-MH akumulatoru).
- Ja uzlādes gaisma mirgo sarkanā krāsā, akumulatora stāvoklis ir tāds, kā norādīts zemāk, un uzlādi nevar sākt.
  - Akumulators izņemts no tikko darbināta instrumenta vai arī ilgu laiku pakļauts tiešai saules gaismai.

– Akumulators ilgu laiku atstāts vietā, kas pakļauta aukstam gaisam.

Ja akumulators ir pārāk karsts, uzlāde sāksies pēc tam, kad akumulatoru būs atdzesējis dzesēšanas ventilators, kas uzstādīts lādētājā. Uzlāde sāksies pēc tam, kad akumulatora kasete sasniegs temperatūru, kurā iespējams veikt uzlādi.

- Ja lādēšanas lampiņa pārmaiņus mirgo zaļā un sarkanā krāsā, uzlāde nav iespējama. Lādētāja vai akumulatora kontakti ir aizsērējuši ar putekļiem vai arī akumulators ir nolietojies vai bojāts.

## Dzesēšanas sistēma

- Lādētājs ir aprīkots ar dzesēšanas ventilatoru, lai uzlabotu sasiluša akumulatora darbību. Dzesēšanas gaisa plūsmas radītā skaņa ir normāla parādība, kas neliecina par lādētāja darbības traucējumiem.
  - Šādos gadījumos iemirgosies dzeltena brīdinājuma gaisma.
    - Dzesēšanas ventilatora darbības traucējumi.
    - Nepietiekama akumulatora dzesēšana, piemēram, putekļu aizsērējuma dēļ.
- Akumulatoru var uzlādēt, ignorējot dzeltenu brīdinājuma gaismu. Taču tādā gadījumā uzlādēšanas laiks būs ilgāks nekā parasti.

Ieklausieties dzesēšanas ventilatora skaņā, pārbaudiet lādētāja un akumulatora atveres – dažreiz var izveidoties putekļu aizsērējums.

- Kaut arī nav dzirdama dzesēšanas ventilatora skaņa, dzesēšanas sistēma ir darba kārtībā, ja vien nemirgo dzeltenā brīdinājuma gaisma.
- Vēdināšanas nodrošināšanai vienmēr turiet lādētāja un akumulatora atveres tīras.
- Ja dzeltenā brīdinājuma gaisma mirgo bieži, izstrādājumam ir nepieciešams remonts vai apkope.

## Kondicionēšanas uzlāde

Kondicionēšanas uzlādē var paildināt akumulatora mūžu, katrā situācijā automātiski piemērojot optimālāko akumulatora uzlādēšanas režīmu.

Šādos apstākļos lietotam akumulatoram bieži būs nepieciešama kondicionēšanas uzlāde, lai novērstu tā ātru nolietošanos. Tādā gadījumā iedegas dzeltenā gaisma.

1. Akumulatora uzlādēšana augstā temperatūrā.
2. Akumulatora uzlādēšanas zemā temperatūrā.
3. Pilna akumulatora lādēšana.
4. Pārmerīga akumulatora izlāde (tiek turpināta akumulatora izlāde, neskatoties uz jaudas zudumu).

Šāda akumulatora uzlādēšanas laiks ir ilgāks nekā parasti.

## Lietošana kopā ar USB ierīci

Šo lādētāju var izmantot kā USB ierīces ārējo barošanas avotu.

1. Atveriet USB barošanas pieslēgvietas vāciņu. Pievienojiet USB vadu pie USB barošanas pieslēgvietas un USB ierīces.
2. Pievienojiet lādētāju barošanas avotam.
3. Kad uzlāde ir pabeigta, atvienojiet lādētāju.

### Piezīme:

- Pirms USB ierīces pievienošanas lādētājam vienmēr izveidojiet USB ierīces datu dubļējumkopiju. Citādi jūs riskējat zaudēt šos datus.
- Lādētājs var nepadot strāvu dažām USB ierīcēm.
- Ja uzlāde ir pabeigta vai lādētājs vairs netiek lietots, atvienojiet USB vadu un aizveriet vāciņu.

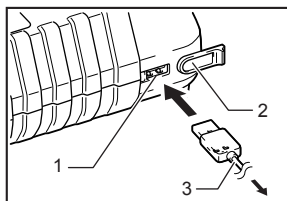

1. USB barošanas pieslēgvietā
2. Vāciņš
3. USB vads

## LIETUVIŲ KALBA

**ĮSPĖJIMAS!** ŠI BUITINĮ PRIETAISĄ GALI NAUDOTI VAIKAI NUO 8 METŲ AMŽIAUS, TAIP PAT - ASMENYS SU FIZINE, JUTIMINE AR PSICHINE NEGALIA ARBA PATIRTIES IR ŽINIŲ STOKOJANTYS ASMENYS, JEI JIE TINKAMAI PRIŽIŪRIMI ARBA JIEMS BUVO PAAIŠKINTA, KAIP SAUGIAI NAUDOTIS BUITINIŲ PRIETAISU IR JIE SUPRANTA SUSIJUSIUS PAVOJUS. VAIKAMS DRAUDŽIAMA ŽAISTI SU BUITINIŲ PRIETAISU. VAIKAMS BE PRIEŽIŪROS NEGALIMA VYKDYTI VALYMO IR TECHININĖS PRIEŽIŪROS DARBŲ.

### Simboliai

Toliau yra nurodyti įrangai naudojami simboliai. Prieš naudodami įsitikinkite, kad suprantate jų reikšmę.



• Naudoti tik patalpose



• Perskaitykite eksploatavimo vadovą.



• DVIGUBA IZOLIACIJA



• Parengtas įkrauti



• Kraunama



• Krovimas baigtas



• Krovimas atidedamas (akumuliatorius aušinamas arba akumuliatorius pernelyg šaltas)



• Sugedęs akumuliatorius



• Kondicionavimas



• Aušinimo sutrikimas



• Stenkitės išvengti trumpojo jungimo.



• Nedeginkite akumuliatoriaus.



• Saugokite akumuliatorių nuo vandens ir lietaus.



• Akumuliatorius visada atiduokite perdirbti.



• Tikta! ES valstybėms

Elektros įrangos ir akumuliatorių neišmeskite kartu su buitiniemis atliekomis!

Laikantis Europos direktyvų dėl elektros ir elektroninės įrangos atliekų, maitinimo elementų ir akumuliatorių bei jų taikymo pagal vietinius įstatymus, elektros įranga ir akumuliatoriai, pasibaigus jų eksploatacijos laikui, privalo būti atskirai surenkami ir grąžinami perdirbti į perdirbimo gamyklą.

1. IŠSAUGOKITE ŠIAS INSTRUKCIJAS – Šioje instrukcijoje yra svarbios akumuliatorių įkroviklio saugos ir naudojimo instrukcijos.
2. Prieš naudodami akumuliatorių įkroviklį, perskaitykite visas instrukcijas ir įspėjimus ant (1) akumuliatorių įkroviklį, (2) akumuliatoriaus ir (3) gaminio, kuriame naudojamas akumuliatorius.
3. DĖMESIO! – Kad sumažintumėte sužeidimų riziką, kraukite tik Makita tipo akumuliatoriais. Kitų tipų akumuliatoriai gali pratrūkti ir sužeisti ar sugadinti turą.
4. Neįkraunamų maitinimo elementų negalima krauti akumuliatorių įkrovikliu.
5. Naudokite maitinimo šaltinį, kurio įtampa atitinka nurodytą akumuliatoriaus duomenų plokštelėje.
6. Nekraukite akumuliatoriaus kasetės, kai arti yra degūs skysčiai ar dujos.
7. Saugokite įkroviklį nuo lietaus ir sniego.
8. Niekada neneškite įkroviklio paėmę už laido arba netrukeltukite atjungdami nuo lizdo.
9. Įkrovę arba prieš mėgindami atlikti techninės priežiūros darbus arba valymą, atjunkite įkroviklį nuo maitinimo šaltinio. Traukite paėmę už kištuko (ne už laido), kai atjungiame įkroviklį.
10. Įsitikinkite, kad laidas padėtas taip, kad ant jo niekas neužlips, neužklius ar kitaip nepažeis ir neapkraus.
11. Nenaudokite įkroviklio su pažeistu laidu ar elektros kištuku. Jei laidas arba kištukas būtų pažeistas, jį privalo pakeisti įgaliotojo „Makita“ techninės priežiūros centro darbuotojai, kad būtų išvengta pavojaus.
12. Nesinaudokite ir neardykite įkroviklio, jei jis buvo stipriai sutrenktas, numestas ar kaip nors kitaip pažeistas; duokite jį patikrinti kvalifikuotam techninės priežiūros darbuotojui. Neteisingai naudojant arba pakartotinai surenkant gali būti elektros smūgio ar gaisro pavojus.
13. Nekraukite akumuliatoriaus kasetės, kai patalpos temperatūra yra ŽEMESNĖ nei 10°C arba AUKŠTESNĖ nei 40°C. Žemoje temperatūroje įkrovimo procesas gali nepasidėti.
14. Nemėginkite naudoti įtampas kėlimo transformatoriaus, variklio generatoriaus arba nuolatinės srovės lizdo.
15. Saugokite, kad niekas neuždengtų ir neužkimštų įkroviklio angų.
16. Į USB maitinimo prievadą nekiškite vinių, vielų ir pan.

### MAKITA akumuliatorių įkrovimas

Šis įkroviklis vienu metu gali įkrauti du akumuliatorius.

1. Prijunkite įkroviklį prie tinkamo kintamosios srovės maitinimo šaltinio. Įkrovimo lempučių imis mirksėti žalia spalva.
2. Stumkite akumuliatorių kasetę į įkroviklį, kol ji sustos įsistatydama į įkroviklio kreipiklį. Įkroviklio kontaktų dangtelis atidaromas įstumiant akumuliatorių kasetę, o uždaromas – ją ištraukiant.
3. Kai akumuliatoriaus kasetė yra įdėta, užsidegs raudona krovimo lempučių ir prasidės krovimas su išankstiniu trumpu muzikiniu garsu, kuris taip pat nuskambės, pranešdamas apie pakrovimo baigtį.
4. Krovimui pasibaigus, krovimo šviesa pasikeis iš raudonos į žalią bei pasigirs garsinis signalas arba skambucio garsas (ilgas pytelėjimas) pranešti apie krovimo baigtį.

5. Krovimo laikas skiriasi nuo temperatūros (10°C – 40°C), kai akumuliatoriaus kasetė yra kraunama ir akumuliatoriaus kasetės būsenų, pvz., akumuliatoriaus kasetė yra nauja ar buvo naudota prieš daug laiko.

6. Pabaigę krauti, išimkite akumuliatoriaus kasetę iš kroviklio ir ištraukite kroviklio kištuką iš elektros lizdo.

### Užbaigto įkrovimo melodijos keitimas

1. Prijunkite akumuliatoriaus kasetę prie to įkrovimo prievado, kurio užbaigto įkrovimo melodiją norite pakeisti. Pasigirsta paskutinė nustatytoji trumpa užbaigto įkrovimo melodija.
2. Išėjus ir vėl įdėjus jį per penkias sekundas po šio veiksmo melodijos garsas pasikeis.
3. Kiekvieną kartą išėjus ir vėl įdėjus jį praėjus dar penkioms sekundėms, melodijos garsas atsistatys.
4. Kai suskambės norimas melodijos garsas, palikite akumuliatoriaus kasetę įdėtą ir krovimas prasidės. Kai pasirinktas „trumpo pyptelėjimo“ modulis, neskambės signalas, pranešantis apie įkrovimo baigtį. (Tylos modulis)

5. Pasibaigus krovimui, žalia šviesa toliau degs, raudona užges, melodinis garsas, iš anksto skambėjęs įdedant akumuliatoriaus kasetę, ar skambučio garsas (ilgas pyptelėjimas) praneš, kad krovimas baigtas. (Jei pasirinktas tylos modulis, garso negirdėsite.)
6. Išankstinis melodinis garsas išliks atmintyje net tuo atveju, kai įkroviklis yra atjungiamas.

Įtampa	9,6 V	12 V	14,4 V	Talpa (Ah)	Krovimo laikas (minutėmis)
Elementų skaičius	8	10	12		
Ni-MH akumuliatoriaus kasetė	BH9020A	—	—	2,0	20
	—	BH1220/C	BH1420	2,0	15
	BH9033A	—	—	3,3	30
	—	BH1233/C	BH1433	3,3	22

Įtampa	14,4 V	18 V	14,4 V	18 V	Talpa (Ah) pagal IEC 61960	Krovimo laikas (minutėmis)
Elementų skaičius	4	5	8	10		
Ličio jonų akumuliatorių kasetė	BL1415	BL1815	—	—	1,3	15
	—	—	BL1430/A	BL1830	3,0	22
	BL1415N/ BL1415NA	BL1815N	—	—	1,5	15
	—	BL1820/ BL1820B	—	—	2,0	24
	—	—	BL1440	BL1840/ BL1840B	4,0	36
	—	—	BL1450	BL1850/ BL1850B	5,0	45
	—	—	—	BL1860B	6,0	55

### PASTABA:

- Akumuliatorių įkroviklis skirtas „Makita“ akumuliatorių kasetėms įkrauti. Nenaudokite jo kitiems tikslams ar kitų gamintųjų akumuliatoriams.
- Įkraunant naują ar ilgai nenaudotą akumuliatorių kasetę, kelis kartus jos visiškai neiškrovus ir vėl neiškrovus, pasiekti maksimalios įkrovos gali nepavykti (Tik Ni-MH akumuliatoriai).
- Jei girdite žybciojimą raudona kontrolinė krovimo lemputė, reiškia akumuliatoriaus būklė atitinka toliau nurodytas sąlygas ir krovimas gali būti nepradėtas.
  - Akumuliatoriaus kasetė ištraukta iš ką tik naudoto įrankio arba akumuliatoriaus kasetė buvo ilgai palikta tiesioginių saulės spindulių apšviestoje vietoje.

- Akumuliatoriaus kasetė buvo ilgai palikta šaltoje vietoje. Kai akumuliatoriaus kasetė yra pernelyg įkaitusi, krovimas bus pradėtas tik po to, kai kroviklyje įrengtas aušintuvas atvėsins akumuliatoriaus kasetę.
- Krovimas bus pradėtas po to, kai akumuliatoriaus kasetės temperatūra pasieks lygį, kuriam esant krovimas yra imanomas.
- Jei krovimo lemputė mirksi pakaitomis žalia ir raudona spalva, įkrovimas yra neįmanomas. Įkroviklio ar akumuliatorių kasetės kontaktai pasidengę dulkeis arba akumuliatorių kasetė susidėvėjusi ar sugadinta.

### Aušinimo sistema

- Šiame įkroviklyje yra aušinimo ventiliatoriai, leidžiantis įkautisiam akumuliatoriui pasiekti tikrąjį našumą. Aušinimo metu yra girdimas išpučiamas aušinimui naudojamas oras: tai reiškia, kad įkroviklis veikia tinkamai.
- Toliau išvardyti atvejai, kuriais įspėjimai mirksės geltona lemputė.
  - Aušinimo ventiliatoriaus veikimo sutrikimai
  - Ne visai atvėsta akumuliatoriaus, gali būti užsikimšęs dulkeis. Akumuliatorių galima įkrauti nepaisant geltonos įspėjamosios lemputės. Tačiau šiuo atveju įkrovimo laikas bus ilgesnis nei paprastai.

- Paklausykite aušinimo ventiliatoriaus ir ventiliacinės angos skleidžiamų garų, minėtos vietos kartais gali būti užsikimšusios dulkeis.
- Aušinimo sistemoje gedimų nėra, jei nėra girdėti aušinimo ventiliatoriaus, bet įspėjamoji lemputė nemirksi.
- Kad užtikrintumėte aušinimą, visuomet priežiūrėkite, kad įkroviklio ir akumuliatoriaus ventiliacijos angos būtų švarios.
- Jei geltona įspėjamoji lemputė mirksi dažnai, gaminiį reikia atiduoti taisyti ar atlikti techninę priežiūrą.

### Įkrovimas kondicionuojant

- Įkrovimas kondicionuojant gali pailginti akumuliatoriaus tarnavimo trukmę; jo metu kiekvieną kartą yra automatiškai ieškoma optimalių įkrovimo sąlygų. Kelis kartus naudojant akumuliatorių toliau išvardintomis sąlygomis, ji būtina „įkrauti kondicionuojant“ – taip jį apsaugosite nuo greito sudėvėjimo. Tokiu atveju užsidega geltona lemputė.
1. Įkraunamas įkaitęs akumuliatorius

2. Įkraunamas šaltas akumuliatorius
  3. Įkraunamas visiškai įkrautas akumuliatorius
  4. Per didelės akumuliatoriaus iškrovimas (akumuliatoriaus iškrovimas tęsiamas nepaisant sumažėjusios galios).
- Tokiu atveju akumuliatoriaus įkrovimo laikas yra ilgesnis nei paprastai.

## Naudojimas su USB įrenginiu

Šis įkroviklis veikia kaip išorinis USB įrenginio maitinimo šaltinis.

1. Atidarykite USB maitinimo šaltinio prievado dangtelį. Prijunkite USB kabelį prie USB maitinimo prievado ir USB įrenginio.
2. Prijunkite įkroviklį prie maitinimo tinklo.
3. Įkrovę atjunkite įkroviklį.

### Pastaba:

- Prieš prijungdami USB įrenginį prie įkroviklio, būtinai padarykite savo USB įrenginio duomenų atsarginę kopiją. Kitą dieną galite prarasti savo duomenis.
- Įkroviklis gali nemaitinti tam tikrų USB įrenginių.
- Kai nenaudojate arba baigę įkrauti, atjunkite USB kabelį ir uždarykite dangtelį.

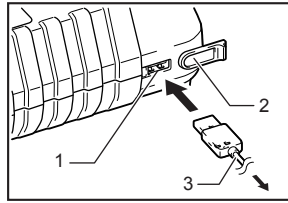

1. USB maitinimo prievadas
2. Dangtelis
3. USB kabelis

## EESTI

**HOIATUS! SEDA SEADET VÕIVAD KASUTADA 8-AASTASED VÕI VANEMAD LAPSED NING PIIRATUD FÜÜSILISTE, SENSOORSETE JA VAIMSETE VÕIMETEGA VÕI PUUDULIKU KOGEMUSE JA TEADMISTEGA ISIKUD, JUHUL KUI KASUTAMINE TOIMUB JÄRELEVALVE ALL VÕI KUI ISIKUD ON ÕPETATUD SEADET OHUTUL MOEL KASUTAMA NING KASUTAMISEGA KAASNEVAID OHTE MÕISTMA. LAPSED EI TOHI SEADMEGA MÄNGIDA. LAPSED EI TOHI SEADET ILMA JÄRELEVALVETA PUHASTADA EGA HOOLDADA.**

### Sümbolid

Järgnevalt kirjeldatakse seadmetel kasutatavaid tingimärke. Veenduge enne seadme kasutamist, et olete nende tähendusest aru saanud.



- Kasutamiseks ainult sisetingimustes



- Lugege kasutusjuhendit.



- KAHEKORDNE ISOLATSIOON



- Valmis laadimiseks



- Laadimine



- Laadimine lõppenud



- Viitlaadimine (aku jahtub või on liiga külm)



- Defektne aku



- Hoolduslaadimine



- Jahutamise viga



- Ärge lühistage akusid.



- Ärge visake akut tulle.



- Ärge tehke akut märjaks ega jätke seda vihma kätte.



- Suunake akud alati korduvkasutusse.



- Üksnes EL liikmesriikidele



- Ärge kõrvaldage elektriseadmeid ega akusid kasutuselt koos olmejäätmetega!  
Vastavalt Euroopa direktiividele, mis käsitlevad elektri- ja elektroonikajäätmeid ning patareisid ja akusid ning patarei- ja akujäätmeid ning nende juurutamist vastavalt riiklikele seadusandlustele, tuleb kasutuselt kõrvaldatavad elektriseadmed ja akud eraldi kokku koguda ja toimetada keskkonnasõbralikku taaskasutuskeskusesse.

1. HOIDKE JUHISED ALLES – juhend sisaldab olulisi akulaadija ohutus- ja kasutusjuhiseid.
2. Enne akulaadija kasutamist lugege kõiki (1) akulaadijal, (2) akul ja (3) akut kasutaval tootel olevaid juhiseid ja hoiatusmärgiseid.
3. ETTEVAATUST – vigastusohu vältimiseks laadige ainult Makita tüüpi laetavaid akusid. Muud tüüpi akud võivad lõhkeda ja põhjustada kehavigastusi ning kahjustusi.
4. Mittelaetavaid akusid ei saa selle akulaadijaga laadida.
5. Kasutage laadijat siidil märgitud pingega toiteallikaga.
6. Ärge laadige akukassetti tuleohtlike vedelike või gaaside läheduses.
7. Ärge jätke laadijat vihma või lume kätte.
8. Ärge kandke laadijat kunagi juhtimest hoides ega tõmmake seda toiteallikast eemaldamiseks.
9. Pärast laadimist või enne hooldust või puhastamist eemaldage laadija toiteallikast. Laadijat toiteallikast eemaldades tõmmake alati pistikust, mitte juhtmest.
10. Veenduge, et juhe on paigutatud nii, et sellele ei astuta peale, selle otsa ei komistata, seda ei kahjustata ega koormata muul moel.
11. Ärge kasutage laadijat, mille toitejuhe või pistik on kahjustunud. Öhu vältimiseks laske kahjustunud toitejuhe või pistik välja vahetada Makita volitatud teeninduskeskuses.
12. Ärge kasutage laadijat ega võtke seda lahti, kui see on saanud terava löögi, kukkunud või saanud muul moel kahjustada. Viige see volitatud hooldusettevõttesse. Nõuetele mittevastav kasutamine või kokkupanek võib lõppeda elektrilöögi või tulekahjuga.

13. Ärge laadige akukassetti ruumis, kus temperatuur on ALLA 10°C või üle 40°C. Madalal temperatuuril ei pruugi laadimine käivituda.

14. Ärge üritage kasutada võimendavat muundurit, mootori generaatorit või alalisvooluallikat.

15. Ärge laske millelgi laadija tõmbeluuke katta või ummistada.

16. Ärge torgake USB-toitepessa naelu, traati vms.

## MAKITA akude laadimine

Selle laadijaga saab korraga laadida kahte akut.

1. Ühendage laadija nõuetekohase vahelduvvooluallikaga. Roheline laadimistuli vilgub korduvalt.
2. Sisestage akukassett laadijasse, kuni selle kohandumine laadijajuhikuga on lõppenud. Laadija klemmikaant on võimalik avada akukasseti sisestamise ja sulgeda akukasseti väljatõmbamise teel.
3. Kui akukassett on sisestatud, süttib punane laadimistuli ja laadimise alguses kõlab eelnevalt seadistatud meloodia kindlustamaks, et teate mis märgib laadimise lõppu.

4. Kui aku laadimine on lõppenud, süttib punase laadimistule asemel roheline ning kõlab meloodia või sumisti heli (pikk piiks), mis teatab, et laadimine on lõppenud.
5. Laadimisaja pikkus sõltub temperatuurist (10°C – 40°C) millel akut laetakse ja akukasseti seisukorrast; näiteks kas tegemist on uue või pikemat aega kasutamata seisnud akuga.
6. Eemaldage akukassett pärast laadimist laadijast ja tõmmake laadija kontaktist välja.

## Laadimise lõppemisest teatava meloodia muutmine

1. Sisestage akukassett laadimisessa, mille puhul soovite muuta laadimise lõppemisest teatavat meloodiat. Käivitus viimati seadistatud laadimise lõppemisest teatav lühike meloodia.
2. Kui võtate aku viie sekundi jooksul heli mängima hakkamises laadijast välja, siis meloodia muutub.
3. Iga viie sekundi sees tehtud aku välja võtmine ja tagasi panemine muudab heli vastavalt heli järjekorrale/ valib järgmise heli.

4. Kui kõlab soovitud meloodia, jätke akukassett laadijasse ja algab laadimisprotsess. Kui on valitud „lühikese piiksu“ režiim, ei kõla mingit lõpetamisest teatavat meloodiat. (Vaikne režiim)
5. Roheline tuli jääb laadimise lõppedes põlema, punane tuli kustub ja kõlab eelnevalt akukasseti sisestades seadistatud meloodia või sumisti heli (pikk piiks), mis teatab laadimise lõppemisest. (Juhul kui on valitud vaikne režiim, mingit heli ei kosta.)
6. Eelnevalt seadistatud meloodia püsib laadija mälus ka pärast vooluvõrgust lahutamist.

Pinge	9,6 V	12 V	14,4 V	Mahtuvus (Ah)	Laadimisaeg (minutid)
Akuelementide arv	8	10	12		
Ni-MH akukassett	BH9020A	—	—	2,0	20
	—	BH1220/C	BH1420	2,0	15
	BH9033A	—	—	3,3	30
	—	BH1233/C	BH1433	3,3	22

Pinge	14,4 V	18 V	14,4 V	18 V	Mahtuvus (Ah) Vastavalt IEC-le (Rahvusvaheline Elektrotehnikako misjon) 61960	Laadimisaeg (minutid)
Akuelementide arv	4	5	8	10		
Li-ion akukassett	BL1415	BL1815	—	—	1,3	15
	—	—	BL1430/A	BL1830	3,0	22
	BL1415N/ BL1415NA	BL1815N	—	—	1,5	15
	—	BL1820/ BL1820B	—	—	2,0	24
	—	—	BL1440	BL1840/ BL1840B	4,0	36
	—	—	BL1450	BL1850/ BL1850B	5,0	45
	—	—	—	BL1860B	6,0	55

## MÄRKUS:

- Akulaadija on ette nähtud Makita akukasseti laadimiseks. Ärge kunagi kasutage seda muul otstarbel või teiste tootjate akude jaoks.
- Kui laadite uut akukassetti või kassetti, mida ei ole pikemat aega kasutatud, võib juhtuda, et see ei saavuta täislaetust enne korduvalt tühjenemist ja uut laadimist (ainult Ni-MH aku).
- Kui laadimistuli vilgub punaselt, siis on aku sellises seisundis, nagu allpool näidatud, ja laadimine ei pruugi alata.
  - Akukassett seadmest, millega on just tööd tehtud või kassett, mis on jäetud pikaks ajaks kohta, kuhu langeb otsene päikesevalgus.

– Akukassett, mis on jäetud pikaks ajaks külma kohta.

Kui akukassett on liiga kuum, siis hakkab laadimine pihta pärast seda, kui laadijasse paigaldatud jahutusventilaator jahutab akukassetti. Laadimine algab pärast seda, kui akukasseti temperatuur saavutab taseme, mil laadimine on võimalik.

- Kui roheline ja punane laadimistuli vilguvad vaheldumisi, ei ole laadimine võimalik. Laadija või akukasseti klemmid on tolmutud või on akukassett kolinud või katki.

## Ventilaator

- Käesoleva laadija on varustatud kuumenenud akule mõeldud jahutusventilaatoriga, et aku oleks võimalik oma tööd teha. Jahutuse ajal tekib teatud heli, mis ei oma laadijale mingit ohtu.
  - Kollane tuli vilgub hoiatuseks järgmistele juhtudel:
    - probleem jahutusventilaatoriga, nagu näiteks tolmuta ummistumise korral
    - aku mittetäielik jahutamise, nagu näiteks tolmuta ummistumise korral
- Akut on võimalik laadida hoolimata kollasest hoiatustulest. Samas on laadimisaeg pikem, kui tavaliselt juhtudel.

Kuulake laadija ja aku jahutusventilaatori tööheli, kuna see võib vahel tulla ümmissuuna.

- Kui kollane hoiatustuli ei vilgu, on jahutusüsteem korras, isegi kui ventilaatorist ei kosta ühtegi heli.
- Hoidke laadija ja aku ventilatsioonivad puhtad, et jahutus saaks toimuda.
- Kui kollane hoiatustuli vilgub sagedasti, tuleb tooted saata parandusse või hooldusesse.



## Hoolduslaadimine

Hoolduslaadimine võib aku eluiga pikendada, selleks igas olukorras optimaalseid laadimistingimusi otsides.

Aku, mida laaditakse korduvalt järgimistes tingimustes, vajab hoolduslaadimist kiire kulumise vältimiseks. Sel juhul süttib kollane tuli.

1. Aku laadimine kõrgetel temperatuuridel
  2. Aku laadimine madalatel temperatuuridel
  3. Täislaetud aku laadimine
  4. Aku ligne tühjakslaadimine (aku tühjakslaadimise jätkamine hoolimata toite madalseisust.)
- Sellise aku laadimisaeg on pikem kui tavaliselt.

## Kasutamine USB-seadmega

Laadija toimib USB-seadme välise toiteallikana.

1. Avage USB-toitepesa kate. Ühendage USB-kaabel USB-toitepesa ja USB-seadmega.
2. Ühendage laadija toiteallikaga.
3. Pärast laadimist eemaldage laadija toiteallika küljest.

### Märkus:

- Enne USB-seadme laadija külge ühendamist varundage alati USB-seadmele olevad andmed. Vastasel juhul võivad andmed kaduma minna.
- Laadija ei pruugi toimida toiteallikana kõigi USB-seadmete puhul.
- Kui te laadijat ei kasuta ning pärast laadimist eemaldage USB-kaabel ja sulgege kate.

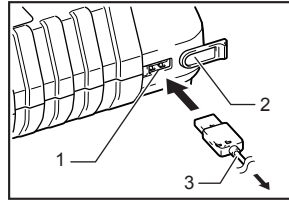

1. USB-toitepesa
2. Kate
3. USB-kaabel

## РУССКИЙ ЯЗЫК

**ПРЕДОСТЕРЕЖЕНИЕ:** ДАННОЕ УСТРОЙСТВО МОЖЕТ ИСПОЛЬЗОВАТЬ ДЕТЯМ СТАРШЕ 8 ЛЕТ И ЛИЦАМ С ОГРАНИЧЕННЫМИ ФИЗИЧЕСКИМИ, ЧУВСТВЕННЫМИ ИЛИ ПСИХИЧЕСКИМИ СПОСОБНОСТЯМИ, А ТАКЖЕ НЕОПЫТНЫМИ ИЛИ НЕКОМПЕТЕНТНЫМИ ЛИЦАМИ, ЕСЛИ ОНИ НАХОДЯТСЯ ПОД НАБЛЮДЕНИЕМ ИЛИ ПОЛУЧАЮТ УКАЗАНИЯ, КАСАЮЩИЕСЯ БЕЗОПАСНОГО ИСПОЛЬЗОВАНИЯ УСТРОЙСТВА, И ПОНИМАЮТ СВЯЗАННЫЕ С ЭТИМ ОПАСНОСТИ. ДЕТИ НЕ ДОЛЖНЫ ИГРАТЬ С УСТРОЙСТВОМ. ЧИСТКА И ТЕХНИЧЕСКОЕ ОБСЛУЖИВАНИЕ ПОЛЬЗОВАТЕЛЕМ НЕ ДОЛЖНЫ ВЫПОЛНЯТЬСЯ ДЕТЬМИ БЕЗ НАБЛЮДЕНИЯ.

### Символы

Следующие объяснения показывают символы, используемые для оборудования. Убедитесь перед использованием, что Вы понимаете их значение.



- Использование только внутри помещения



- ДВОЙНАЯ ИЗОЛЯЦИЯ



- Зарядка



- Задержка зарядки (Охлаждение батареи или слишком холодная батарея)



- Кондиционирование



- Не закорачивайте батареи.



- Не подвергайте батарею воздействию воды или дождя.



- Только для стран ЕС

Не утилизируйте электрическое оборудование или батарейный блок вместе с бытовым мусором! Согласно Европейским Директивам об утилизации электрического и электронного оборудования, о батареях и аккумуляторах, об утилизации батарей и аккумуляторов, и для их выполнения в соответствии с государственными законами, электрическое оборудование, батареи и батарейный(е) блок(и), срок службы которых истек, должны быть отдельно собраны и возвращены в пункт утилизации вторично используемого сырья с соблюдением требований охраны окружающей среды.



- Прочитайте инструкцию по эксплуатации.



- Готово для зарядки



- Зарядка завершена



- Дефектная батарея



- Неисправность охлаждения



- Не сжигайте батарею.



- Всегда выбрасывайте батареи для рециркуляции.

- СОХРАНИТЕ ЭТУ ИНСТРУКЦИЮ – Это руководство содержит важные инструкции по безопасности и эксплуатации зарядного устройства для батареи.
- Перед использованием зарядного устройства для батареи прочитайте все эти инструкции и предупреждающие отметки на (1) зарядном устройстве для батареи, (2) батарее и (3) изделии, использующем батарею.
- ПРЕДУПРЕЖДЕНИЕ** - Чтобы уменьшить риск получения травмы, заряжайте только батареи Makita перезаряжаемого типа. Другие типы батарей могут взорваться, причинив травму или повреждение.
- Неперезаряжаемые батареи невозможно заряжать с помощью этого зарядного устройства для батареи.
- Используйте источник электропитания с напряжением, указанным на таблице номиналов зарядного устройства для батареи.
- Не заряжайте батарейный картридж в присутствии огнеопасных жидкостей или газов.
- Не подвергайте зарядное устройство воздействию дождя или снега.
- Никогда не переносите зарядное устройство за шнур и не дергайте его, чтобы отсоединить от розетки.
- После зарядки и перед проведением какого-либо технического обслуживания или чистки отсоедините зарядное устройство от источника электропитания. При отсоединении зарядного устройства тяните за штепсельную вилку, а не за шнур.
- Убедитесь в том, что шнур расположен таким образом, что на него не наступят, не сползнут, и не случится что-либо еще, приводящее к повреждению или напряжению.
- Не эксплуатируйте зарядное устройство с поврежденным шнуром или штепсельной вилкой. В случае повреждения шнура или штепсельной вилки обратитесь в уполномоченный центр по техобслуживанию Makita для замены во избежание опасности.
- Не эксплуатируйте и не разбирайте зарядное устройство, если его сильно ударили, уронили или повредили каким-либо иным способом; обратитесь к квалифицированному специалисту по техобслуживанию. Неправильное использование или разборка могут привести к опасности поражения электрическим током или пожару.
- Не заряжайте батарейный картридж при комнатной температуре зарядка может не начинаться. При холодной температуре зарядка может не начинаться.
- Не пытайтесь использовать повышающий трансформатор, генератор или штепсельную розетку постоянного тока.
- Не позволяйте никаким предметам закрывать или засорять вентиляционные отверстия зарядного устройства.
- Не вставляйте в USB-порт подачи питания гвозди, проволоку и т.п.

### Зарядка для батарей МАКИТА

Данное зарядное устройство может заряжать одновременно две батареи.

- Подсоедините зарядное устройство к источнику питания переменного тока с соответствующим напряжением. Лампочка зарядки будет повторно мигать зеленым цветом.
- Вставьте батарейный картридж полностью в зарядное устройство до тех пор, пока он не остановится, регулируя направляющую зарядного устройства. Крышка разъемов может быть открыта при вставлении и закрыта при вынимании батарейного картриджа.
- Когда вставлен батарейный картридж, загорится красная лампочка зарядки, и начнется зарядка с заранее установленной короткой мелодией, звучащей для проверки того, что звук слышен при уведомлении о завершении зарядки.
- По окончании зарядки лампочка зарядки изменит цвет с красного на зеленый, и будет звучать мелодия или звуковой сигнал (длинные гудки) для уведомления о завершении зарядки.
- Время зарядки отличается в зависимости от температуры (10°C – 40°C), при которой заряжается батарейный картридж, и от условий батарейного блока, таких как новый или долгое время не использовавшийся батарейный картридж.
- После зарядки удалите батарейный картридж из зарядного устройства и отсоедините его от сети.

### Изменение звука мелодии полной зарядки

- Вставьте батарейный картридж в порт зарядки, для которого Вы хотите изменить звук мелодии полной зарядки. Это вызовет последний предустановленный короткий звук мелодии полной зарядки.
- Удаление и его повторная установка в течение пяти секунд после выполнения этого действия приводят к изменению мелодии.
- Каждый раз при удалении и его повторной установке в течение пяти секунд после этого мелодии меняются по порядку.
- Когда звучит нужная мелодия, оставьте батарейный картридж вставленным, и начнется зарядка. Когда выбран режим "коротких гудков", сигнал завершения зарядки не звучит. (Режим молчания)
- По окончании зарядки зеленая лампочка зарядки остается гореть с испускаемым красным светом, и звучит мелодия, заранее установленная при установке батарейного картриджа, или звуковой сигнал (длинные гудки) для уведомления о завершении зарядки. (При выбранном режиме молчания звука нет.)
- Заранее установленная мелодия сохраняется, даже при отсоединении зарядного устройства от сети.

Напряжение	9,6 V	12 V	14,4 V	Емкость (Ач)	Время зарядки (минуты)
Число элементов	8	10	12		
Никель-металлогидридный батарейный картридж	VH9020A	—	—	2,0	20
	—	VH1220/C	VH1420	2,0	15
	VH9033A	—	—	3,3	30
	—	VH1233/C	VH1433	3,3	22

Напряжение	14,4 V	18 V	14,4 V	18 V	Емкость (Ач) в соответствии с IEC61960	Время зарядки (минуты)
	4	5	8	10		
Ионно-литиевый батарейный картридж	BL1415	BL1815	—	—	1,3	15
	—	—	BL1430/A	BL1830	3,0	22
	BL1415N/ BL1415NA	BL1815N	—	—	1,5	15
	—	BL1820/ BL1820B	—	—	2,0	24
	—	—	BL1440	BL1840/ BL1840B	4,0	36
	—	—	BL1450	BL1850/ BL1850B	5,0	45
	—	—	—	BL1860B	6,0	55

#### ПРИМЕЧАНИЕ:

- Зарядное устройство для батарей предназначено для зарядки батарейного картриджа Makita. Никогда не используйте его для других целей или для батарей, произведенных другим производителем.
- Когда Вы заряжаете батарейный картридж, который является новым или не использовался в течение длительного времени, то он может зарядиться не полностью до того, как картридж не разрядится полностью и не зарядится несколько раз. (Только никель-металлогидридная батарея)
- При возможном мигании лампы зарядки красным светом батарея находится в одном из следующих состояний, и зарядка может не начаться.
  - Батарейный картридж от только что работавшего инструмента или батарейный картридж, который был оставлен в месте, подверженному воздействию прямых солнечных лучей в течение длительного времени.

— Батарейный картридж, который был оставлен в течение длительного времени в месте, подверженном влиянию холодного воздуха.

Когда батарейный картридж слишком горячий, зарядка начнется после охлаждения батарейного картриджа с помощью охлаждающего вентилятора, установленного в зарядное устройство. Зарядка начнется после того, как температура батарейного картриджа достигнет значения, при котором зарядка возможна.

- Если лампа зарядки мигает попеременно зеленым и красным светом, то зарядка невозможна. Клеммы на зарядном устройстве или батарейном картридже загрязнились пылью, завершился срок службы батарейного картриджа или он поврежден.

#### Система охлаждения

- Это зарядное устройство снабжено охлаждающим вентилятором для перегревшейся батареи с целью обеспечения удовлетворительного функционирования батареи. Звук охлаждающего воздуха издается во время охлаждения, что не означает неисправность зарядного устройства.
- Желтая лампа будет мигать с целью предупреждения в следующих случаях.
  - Неисправность охлаждающего вентилятора
  - Неполное охлаждение батареи, такое, как при засорении пылью.

Зарядка батареи возможна несмотря на желтую предупреждающую лампу. Но время зарядки в этом случае будет больше, чем обычно. Проверьте звук охлаждающего вентилятора, вентиляционное отверстие на зарядном устройстве и батарее, которое может иногда быть засорено пылью.

- Система охлаждения находится в порядке, даже если звук не издается охлаждающим вентилятором, если не мигает желтая предупреждающая лампа
- Всегда сохраняйте в чистоте вентиляционное отверстие на зарядном устройстве и батарее для охлаждения.
- Если желтая предупреждающая лампа мигает часто, следует отослать изделия для ремонта или техобслуживания.

#### Условная зарядка

Условная зарядка может продлить срок службы батареи с помощью автоматического поиска оптимальных условий зарядки для батарей в каждой ситуации. Батарея, применяющаяся при следующих условиях, часто требует "условной зарядки" для предотвращения быстрого выхода из строя. В таком случае загорается желтая лампа.

- Перезарядка батареи при её высокой температуре
- Перезарядка батареи при её низкой температуре
- Перезарядка полностью заряженной батареей
- Излишняя разрядка батареи (продолжение разрядки батареи несмотря на малый заряд.)

Время зарядки такой батареей составляет больше, чем обычно.

#### Использование с USB-устройством

Данное зарядное устройство работает как внешний источник питания для USB-устройства.

- Откройте крышку USB-порта подачи питания. Подсоедините USB-кабель к USB-порту подачи питания и к USB-устройству.
- Подсоедините зарядное устройство к источнику электропитания.
- После зарядки отсоедините зарядное устройство от сети.

#### Примечание:

- Перед подсоединением USB-устройства к зарядному устройству обязательно выполните резервное копирование Ваших данных с USB-устройства. Противном случае Ваши данные могут быть утеряны при определенных обстоятельствах.
- Зарядное устройство может не подавать питание на некоторые USB-устройства.
- Удалите USB-кабель и закройте крышку, когда оно не используется или после зарядки.

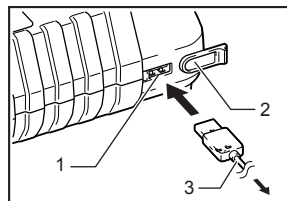

- USB-порт подачи питания
- Крышка
- USB-кабель

**警告：**本设备可被 8 岁及以上小孩和身体、感官或心智功能不健全或缺乏经验和知识的人使用，但必须对其监管或给予有关安全使用设备方面的指导并且他们理解所涉及的危险。小孩不应玩耍本设备。在没有监管的情况下，不应当让小孩进行清洁和用户维护。

**符号**

以下显示用于本设备的符号。使用之前，确保您理解其含义。

- |  |   |   |                |
|--|---|---|----------------|
|  | • 只能在室内使用   |  | • 请阅读使用说明书。    |
|  | • 双重绝缘  |  | • 准备充电         |
|  | • 充电  |  | • 充电完毕         |
|  | • 延迟充电（正在冷却电池或电池太冷）   |  | • 充电失效         |
|  | • 保养  |  | • 冷却不正常        |
|  | • 不要使电池短路。  |  | • 切勿用火焚烧来损坏电池。 |
|  | • 切勿使电池浸水或受到雨淋。   |  | • 请务必循环利用电池。   |
|  | • 仅适用欧盟国家<br>不要与家用废弃物一起处理电气设备或电池组！<br>遵守关于废弃电气和电子设备和电池和蓄电池和废弃电池的欧洲指令及其按照国家法律的实施，达到其寿命终点的电气设备和电池和电池组必须分开收集并返回到环保的回收设施。 |   |                |

- 保管本说明书 — 本说明书包含电池充电器重要的安全和操作指示。
- 在使用电池充电器之前，阅读 (1) 电池充电器、(2) 电池和 (3) 使用电池的 产品上的所有指示和注意事项标记。
- 注意 — 为减少造成伤害的危险，请只充电 Makita 型充电电池。其他类型的电池可能会爆炸，导致受伤和受损。
- 非充电电池不能用本电池充电器充电。
- 使用充电器铭牌上规定电压的电源。
- 请勿在有可燃性液体或气体存在的地方充电。
- 请勿让充电器被雨或雪淋湿。
- 切勿抓住电线携带充电器或拉扯电线从插座拔下。
- 充电之后或在进行任何维护或清洁之前，请从电源插座拔下充电器。断开充电器连接时，请抓住插头拔下而不要拉扯电线。
- 确保电线位置不会被踩上、绊到等而导致损坏或绷紧。
- 请勿操作电线或插头损坏的充电器。如果电线或插头损坏，请向 Makita 授权维修中心要求更换，以防隐患。
- 如果充电器受到冲击、摔落等造成损坏，请勿操作或拆解充电器，而是交由合格的维修人员进行维修。使用不正确或进行改造可能导致触电或火灾。
- 当室温低于 10° C 或高于 40° C 时，请勿给电池盒充电。在较冷的温度下，可能无法充电。
- 请勿使用升压变压器、引擎发电机或直流电源插座。
- 请勿让任何东西盖住或堵住充电器通风孔。
- 请勿将钉子、电线等物件插入 USB 供电端口。

**为 MAKITA 电池充电**

本充电器可同时对两块电池充电。

- 将充电器插入合适的交流电源插座。充电指示灯将呈绿色反复闪烁。
- 将电池盒插入充电器内，使它完全固定于充电器导槽。插入电池盒时，可以打开充电器端子盖；取出电池盒时，可以关闭充电器端子盖。
- 插入电池盒时，红色的充电指示灯将点亮并充电开始。此时，将发出预设的短促乐音以确认充电完成时的提示乐音。
- 充电结束时，充电指示灯将从红色变为绿色，同时发出一乐音或蜂音（长的蜂鸣音）来提示充电已经完成。
- 充电时间根据电池盒充电时的温度（10° C 至 40° C）以及电池盒的使用情况（如新电池盒或已经长时间使用过的电池盒）不同而异。
- 为电池充电后，将电池盒从充电器中取出并拔下充电器的电源插头。

**改变充电完毕时的提醒乐音**

- 将电池盒插入要改变其充电完毕提醒音乐的那个充电端口，随即会播放上次预设的提醒充电完毕的短暂音乐。
- 此操作后 5 秒钟以内取下和重新插上充电器的时可改变该乐音。
- 此后每次 5 秒钟以内取下和重新插上充电器可依序改变该乐音。
- 当发出所希望的乐音时，使电池盒处于插上状态，充电将开始。当选择“短蜂鸣音”模式时，将不会发出完成充电信号。（静音模式）
- 充电结束时，绿色指示灯将保持点亮状态而红色指示灯则熄灭。将发出插入电池盒时所预设的乐音或蜂鸣音以提示充电完成。（选择静音模式时，将不发出声音。）
- 即使拔下充电器电源插头，仍会保存所预设的乐音。

电压	9.6 V	12 V	14.4 V	容量 (安培-小时)	充电时间(分)
节数	8	10	12		
镍-镉电池盒	BH9020A	—	—	2.0	20
	—	BH1220/C	BH1420	2.0	15
	BH9033A	—	—	3.3	30
	—	BH1233/C	BH1433	3.3	22

电压	14.4 V	18 V	14.4 V	18 V	容量 (安培-小时) 根据 IEC61960	充电时间(分)
节数	4	5	8	10		
锂离子电池盒	BL1415	BL1815	—	—	1.3	15
	—	—	BL1430/A	BL1830	3.0	22
	BL1415N/ BL1415NA	BL1815N	—	—	1.5	15
	—	BL1820/BL1820B	—	—	2.0	24
	—	—	BL1440	BL1840/BL1840B	4.0	36
	—	—	BL1450	BL1850/BL1850B	5.0	45
	—	—	—	BL1860B	6.0	55

#### 注解：

- 本充电器专门为 Makita 电池盒设计，请勿用于其他目的或其他品牌的电池盒。
- 当给新的或长时间未使用的电池盒充电时，可能不能充足电，请将其完全放电后再充电数次才能充足电。（仅可用于镍-镉电池）
- 如果充电指示灯闪烁红色，则表示如下的电池状态，并且可能无法开始充电。
  - 电池盒取自刚工作过的工具或电池盒被长时间放置在暴露于直射阳光的地方。

- 电池盒被长时间放置在暴露于冷气的地方。当电池盒太热时，充电将在充电器上安装的冷却风扇冷却电池盒之后开始。充电将在电池盒温度达到可充电的程度之后开始。
- 充电指示灯在绿色和红色之间交互闪烁时，无法进行充电；因为充电器或电池盒的端子上覆有灰尘或电池盒磨损或损毁。

#### 冷却系统

- 该充电器为已热的电池配有冷却风扇以使电池能完成其功能。冷却时会发出冷却空气的声音，并不表示充电器故障。
  - 下列情形下，充电指示灯会发出黄色闪光：
    - 冷却风扇故障
    - 无法将电池完全冷却，例如灰尘堵塞。
- 尽管黄色指示灯亮起，电池仍可以充电，但是充电会花比较长的时间。

- 检查冷却风扇的声音，充电器和电池的排风口，排风口有时会被灰尘阻塞。
- 充电指示灯没有发出黄色闪光时，充电器是正常的，即使它没有发出冷却风扇的声音。
- 要保持为冷却用的充电器和电池的排风口的清洁。
- 充电指示灯经常发出黄色闪光时，应将充电器送修或维护。

#### 保养充电

保养充电会自动搜寻各种状况下的电池最佳充电条件，因而延长电池的寿命。

在下列条件下反复使用电池时需要进行“保养充电”以防止电池很快用完。此时，黄色指示灯将点亮。

1. 电池在高温下充电

2. 电池在低温下充电
  3. 已充饱的电池还继续使用
  4. 电池过度放电（电池没电还继续使用。）
- 上述电池的充电时间会比一般的充电时间长。

#### 与 USB 设备配合使用

本充电器可作为外部电源为 USB 设备供电。

1. 打开 USB 供电端口的盖子。用 USB 线将 USB 供电端口与 USB 设备相连接。
2. 将充电器插入电源插座。
3. 充电完毕后，拔下充电器。

#### 注解：

- 务必先要备份 USB 设备上的数据，然后再将 USB 设备连接到充电器。否则有可能发生数据丢失的情况。
- 某些 USB 设备可能无法使用本充电器供电。
- 不使用或者充电后，应拔下 USB 线，盖好 USB 供电端口盖。

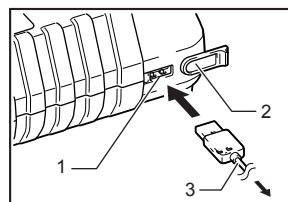

1. USB 供电端口
2. 端口盖
3. USB 线

1. شارژ باتری با درجه حرارت بالا آن
  2. شارژ باتری با دمای پایین آن
  3. شارژ از شارژ کامل باتری
  4. بیش از تخلیه باتری (باتری به ترشحات با وجود پایین از قدرت ادامه خواهد داد).
- زمان شارژ باتری چنین طولانی تر از معمول است.

### استفاده با دستگاه USB

1. جایگاه تغذیه توان USB
2. قاب
3. کابل USB

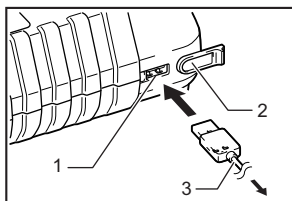

این شارژر بعنوان یک منبع تغذیه بیرونی برای دستگاه USB کار می کند.

1. قاب جایگاه تغذیه توان USB را باز کنید. کابل USB را به جایگاه تغذیه توان USB و دستگاه USB وصل کنید.
2. شارژر را به یک منبع توان وصل کنید.
3. بعد از شارژ، شارژر را از برق بکشید.

**تذکر:**

- پیش از متصل کردن دستگاه USB به شارژر، همیشه از داده های دستگاه USB پشتیبان گیری کنید. در غیراینصورت ممکن است به هر دلیلی داده های خود را از دست بدهید.
- شارژر ممکن است قادر به تغذیه توان برای برخی دستگاه های USB نباشد.
- هنگامی که از آن استفاده نمی کنید و یا بعد از شارژ، کابل USB را برداشته و قاب را ببندید.

## شارژ کردن برای باتری های ماکیتا

- این شارژر می تواند همزمان دو باتری را شارژ کند.
- شارژر را به یک منبع تغذیه برق متناسب وصل کنید. چراغ شارژ بطور مکرر به رنگ سبز چشمک می زند.
- کارتريج باتری را در شارژر قرار دهید تا در جای صحیح در برابر هادی شارژر متوقف شود. درپوش پالایه شارژر را می توان با قرار دادن کارتريج باتری باز و با بیرون کشیدن آن بست.
- هنگامی که کارتريج باتری قرار داده می شود، چراغ شارژ قرمز رنگ روشن شده و شارژ با یک ملودی کوتاه از پیش تعیین شده جهت اطمینان دادن شروع خواهد شد، همین صدا در پایان شارژ نیز به گوش خواهد رسید.

## عوض کردن صدای ملودی تکمیل شارژ

- کارتريج باتری را در جایگاه شارژی که می خواهید صدای ملودی تکمیل شارژ آنرا عوض کنید قرار دهید. این کار آخرین صدای ملودی مختصر تکمیل شارژ از پیش تنظیم شده را پخش خواهد کرد.
- اگر آنرا ظرف مدت پنج ثانیه بعد از این کار برداشته و دوباره قرار دهید، صدای ملودی عوض خواهد شد.
- هر بار که آنرا دوباره ظرف مدت پنج ثانیه بعد از این کار برداشته و قرار دهید، صدای ملودی به ترتیب عوض خواهد شد.
- هنگامی که صدای ملودی دلخواه را شنیدید، دیگر کارتريج باتری را بردارید و عملیات شارژ شروع خواهد شد. اگر حالت «بیب کوتاه» انتخاب شده باشد، هشدار تکمیل شارژ به گوش خواهد رسید. (حالت بیصدا)

مدت زمان شارژ (دقیقه)	ظرفیت (امپر ساعت)	14.4 ولت	12 ولت	9.6 ولت	ولتاژ
		12	10	8	تعداد سلول ها
20	2.0	—	—	BH9020A	کارتريج باتری نیکل-مثال هیدرید Ni-MH
15	2.0	BH1420	BH1220/C	—	
30	3.3	—	—	BH9033A	
22	3.3	BH1433	BH1233/C	—	

مدت زمان شارژ (دقیقه)	ظرفیت (امپر ساعت) مطابق با IEC61960	18 ولت	14.4 ولت	18 ولت	14.4 ولت	ولتاژ
		10	8	5	4	تعداد سلول ها
15	1.3	—	—	BL1815	BL1415	کارتريج باتری یون-لیتیوم
22	3.0	BL1830	BL1430/A	—	—	
15	1.5	—	—	BL1815N	BL1415NA/BL1415N	
24	2.0	—	—	BL1820B/BL1820	—	
36	4.0	BL1840B/BL1840	BL1440	—	—	
45	5.0	BL1850B/BL1850	BL1450	—	—	
55	6.0	BL1860B	—	—	—	

## تذکر:

- این شارژر باتری برای شارژ کردن کارتريج باتری ماکیتا می باشد. هرگز از آن برای هیچ منظور دیگری و یا شارژ کردن باتری های سازندگان دیگر استفاده نکنید.
- اگر یک کارتريج باتری نو یا یک کارتريج باتری را که برای مدت طولانی استفاده نشده است شارژ می کنید، امکان دارد قبل از چند بار تخلیه کامل و شارژ مجدد به ظرفیت کامل شارژ نرسد. (فقط باتری نیکل-مثال هیدرید (Ni-MH))
- اگر شارژ نور ممکن است در رنگ قرمز فلش، وضعیت باتری به شرح زیر است و ممکن است شارژ شروع نمی شود.
- کارتريج باتری را از ابزار اداره می شود و یا فقط کارتريج باتری است که در یک مکان برای مدت طولانی در معرض مستقیم نور خورشید به سمت چپ.

## سیستم خنک کننده

- این شارژر است با خنک کننده فن برای باتری گرم به منظور فعال کردن باتری برای اثبات عملکرد خود میچیز شده است. صدا از خنک کننده با هوا بیرون می آید در حین سرد شدن، که به معنی بدون مشکل در شارژر.
- نور زرد برای هشدار در موارد زیر فلش.
  - مشکل در فن خنک کننده
  - داللود ناهمگن کردن باتری، مانند، که با گرد و غبار گرفته
- باتری را می توان در وجود چراغ اخطار زرد عنوان شده است. اما زمان شارژ خواهد شد طولانی تر از معمول در این مورد.

- اتمام صدای فن خنک کننده، بیرون ریختن در شارژر و باتری، که می تواند گاهی اوقات با گرد و غبار گرفته است.
- سیستم خنک کننده است به منظور هر چند بدون صدا از فن خنک کننده بیرون می آید، اگر چراغ اخطار زرد نوازد است.
- همیشه تمیز در شارژر و باتری درجه های خنک نگه می دارد.
- محصولات باید فرستاده شده به تعمیر و یا تعمیر و نگهداری، در صورتی که چراغ اخطار زرد غالباً به فلش.

**هشدار:** این دستگاه توسط کودکان از سن 8 سال به بالا و اشخاص دارای توانایی جسمانی، حسی و یا ذهنی محدود و یا افراد فاقد تجربه و دانش قابل استفاده می باشد به شرطی که به روشی ایمن درباره طرز کار دستگاه آموزش ببینند و یا تحت نظارت با دستگاه کار کنند و خطرات موجود را درک نمایند. کودکان نباید با دستگاه بازی کنند. کودکان نباید بدون نظارت به انجام امور تمیز کردن دستگاه و یا کارهای نگهداری مخصوص کاربران اقدام نمایند.

علامت و نشانه ها

در اینجا علامت و نشانه های کار رفته برای این دستگاه را مشاهده خواهید کرد. پیش از استفاده باید حتماً از معنی این علامت و نشانه ها آگاه باشید.

- فقط برای استفاده در داخل ساختمان 
- فقط برای استفاده در داخل ساختمان 
- عایق دوپل 
- آماده شارژ 
- شارژ کردن 
- شارژ تکمیل شده است 
- تاخیر در شارژ (باتری در حال خنک شدن یا باتری خیلی سرد است) 
- شارژ مجدد عادی 
- باتری ها را اتصال کوتاه نکنید. 
- باتری را در معرض آب یا باران قرار ندهید. 
- همیشه باید باتری ها را بازیافت کنید. 

فقط برای کشورهای عضو EU (اتحادیه اروپا)

هرگز نباید لوازم و تجهیزات الکتریکی یا بسته باتری را همراه با سایر زباله های خانگی دور بیندازید!

در تطابق با مصوبات اروپایی، درباره لوازم مستعمل الکتریکی و الکترونیکی و باتری ها و انباره ها و باتری ها و انباره های مستعمل و اجرای آنها با توجه به مقررات و قوانین کشوری، لوازم الکتریکی و باتری ها و بسته(های) باتری که عمر مفید آنها به پایان رسیده است باید جداگانه جمع آوری شده و به یک مرکز بازیافت سازگار با محیط زیست فرستاده شوند.

1. این دستورالعمل ها را نگهداری کنید - این دفترچه راهنما حاوی اطلاعات مهم ایمنی و دستورالعملهای شارژر باتری است.
2. پیش از اینکه از شارژر باتری استفاده کنید، کلیه دستورالعملها و علامت هشدار دهنده (1) شارژر باتری، (2) باتری و (3) دستگاه استفاده کننده از باتری را مطالعه نمایید.
3. احتیاط - به منظور کاستن از خطر جراثیم، فقط باتری های قابل شارژ ماکیتا را شارژ کنید. امکان دارد سایر باتری ها منفجر شده و باعث جراثیم فردی و یا خسارت شوند.
4. امکان شارژ کردن باتری های غیر قابل شارژ با این دستگاه شارژر وجود ندارد.
5. ولتاژ منبع تغذیه مورد استفاده باید با آنچه که روی پلاک شارژر نوشته شده است برابر باشد.
6. در مکانهایی که مایعات یا گازهای قابل اشتعال وجود دارد از شارژ کردن کاربرتیج باتری خودداری کنید.
7. شارژر را در معرض باران یا برف قرار ندهید.
8. هرگز شارژر را با گرفتن سیم آن حمل نکرده و یا آنرا برای جدا کردن از پریز نکشید.
9. بعد از شارژ کردن و یا پیش از انجام هرگونه کار نگهداری یا تمیز کردن، شارژر را از منبع تغذیه جدا کنید. برای جدا کردن شارژر، دوشاخه آنرا بکشید و از کشیدن سیم آن خودداری کنید.
10. اطمینان حاصل کنید که سیم در جایی نباشد که زیر پا قرار بگیرد، به پای کسی گیر کند و یا در معرض آسیب دیدن یا کشیده شدن قرار گیرد.
11. اگر سیم یا دوشاخه شارژر آسیب دیده است از آن استفاده نکنید. اگر سیم یا دوشاخه آسیب دیده است، برای جلوگیری از ایجاد خطرات از یک مرکز خدمات مجاز ماکیتا بخواهید آنرا برای شما عوض کنند.
12. اگر ضربه محکمی به شارژر وارد شده، شارژر به زمین افتاده، یا به هر ترتیب دیگری آسیب دیده است نباید با آن کار کنید و یا آنرا باز کنید؛ آنرا نزد یک سرویس کار واجد صلاحیت ببرید. استفاده نادرست یا دوباره جمع کردن قطعات باز شده می تواند باعث بروز خطر برق گرفتگی یا آتش سوزی شود.
13. اگر دمای اتاق زیر 10 درجه سانتیگراد (50 درجه فارنهایت) یا بالای 40 درجه سانتیگراد (104 درجه فارنهایت) است، از شارژ کردن کاربرتیج باتری خودداری کنید. عمل شارژ ممکن است در ماههای پایین آغاز نشود.
14. از ترانس های افزایشنده یا موتور برق یا پریز برق مستقیم استفاده نکنید.
15. اجازه ندهید هیچ چیز روی منافذ تهویه شارژر را بپوشاند یا آنها را مسدود کند.
16. میخ، سیم و غیره در جایگاه تغذیه توان USB وارد نکنید.



يمكن شحن البطارية على الرغم من مصباح التحذير الأصفر. لكن زمن الشحن سوف يكون أطول من المعتاد في هذه الحالة. تحقق من صوت مروحة التبريد، فتحة التهوية الموجودة على الشاحن والبطارية، التي يمكن أن تكون مسدودة بالأتربة أحياناً. يكون نظام التبريد سليم على الرغم من عدم خروج أي صوت لمروحة التبريد، في حالة عدم وميض مصباح التحذير الأصفر.

• احرص دائماً على تنظيف فتحة التهوية الموجودة على الشاحن والبطارية من أجل التبريد.

• ينبغي إرسال المنتجات للإصلاح أو الصيانة، في حالة وميض مصباح التحذير الأصفر بشكل متكرر.

- هذا الشاحن مجهز بمروحة تبريد للبطارية الساخنة من أجل تمكين البطارية من إثبات أداءها. يخرج صوت هواء التبريد أثناء التبريد، والذي يعني عدم وجود مشكلة في الشاحن.
- سوف يومض المصباح الأصفر للتحذير في الحالات التالية.
  - مشكلة في مروحة التبريد
  - تبريد غير كامل للبطارية، مثل، الإمداد بالأكبرية

### موانمة الشحن

يمكن موانمة الشحن إبطاء عمر البطارية من خلال البحث تلقائياً عن حالة الشحن المثلى للبطاريات في كل حالة.

البطارية المستخدمة في الحالات التالية تتطلب "موانمة الشحن" بشكل متكرر للحيلولة دون التلف السريع. في تلك الحالة، يضيء المصباح الأصفر.

1. إعادة شحن البطارية مع ارتفاع درجة حرارتها
  2. إعادة شحن البطارية مع انخفاض درجة حرارتها
  3. إعادة شحن بطارية مشحونة بالكامل
  4. التفرغ الزائد للبطارية (الاستمرار في تفريغ البطارية على الرغم من انخفاض القدرة).
- يكون زمن الشحن لمثل هذه البطارية أطول من المعتاد.

### الاستخدام مع جهاز USB

يعمل هذا الشاحن كمصدر طاقة خارجي لجهاز USB.

1. افتح غطاء منفذ USB الخاص بمصدر الطاقة. قم بتوصيل كابل USB بمنفذ USB الخاص بمصدر الطاقة وجهاز USB.
2. قم بتوصيل الشاحن في مصدر طاقة.
3. بعد الشحن، افصل الشاحن.

### ملاحظة:

- قبل توصيل جهاز USB بالشاحن، قم دائماً بعمل نسخ احتياطي لبياناتك من جهاز USB. والا قد تخسر بياناتك بواسطة أي احتمال.
- قد لا يقوم الشاحن بإمداد الطاقة لبعض أجهزة USB.
- عند عدم الاستخدام أو بعد الشحن، انزع كابل USB وأغلق الغطاء.

1. منفذ USB الخاص بمصدر الطاقة
2. الغطاء
3. كابل USB

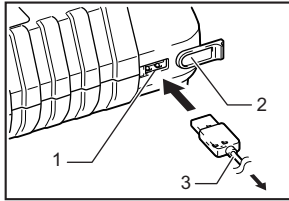

## شحن بطاريات MAKITA

يستطيع هذا الشاحن شحن بطريّتان في نفس الوقت.

1. قم بتوصيل الشاحن في مصدر جهد التيار المتردد المناسب. سوف يومض مصباح الشحن باللون الأخضر بشكل متكرر.
2. قم بإدخال خرطوشة البطارية في الشاحن حتى تتوقف وتتواءم مع الدليل الخاص بالشاحن. يمكن لغطاء أطراف التوصيل الخاصة بالشاحن أن يفتح مع الإدخال ويغلق مع سحب خرطوشة البطارية.
3. عندما يتم إدخال خرطوشة البطارية، سوف يضيء مصباح الشحن أحمر اللون وسيبدأ الشحن مع خروج صوت نغمة قصيرة معدة مسبقاً لتأكيد أي الأصوات سوف يخرج للإندازر باكتمال الشحن.
4. مع انتهاء الشحن، سوف يتغير مصباح الشحن من الأحمر إلى الأخضر ويخرج صوت نغمة أو صوت طنين (صفارة طويلة) للإندازر باكتمال الشحن.
5. يختلف زمن الشحن حسب درجة الحرارة (10 درجة مئوية (50 درجة فهرنهايت) – 40 درجة مئوية (104 درجة فهرنهايت)) التي يتم فيها شحن خرطوشة البطارية وظروف خرطوشة البطارية، مثل خرطوشة البطارية الجديدة أو التي لم تستخدم لمدة طويلة من الزمن.
6. بعد الشحن، انزع خرطوشة البطارية من الشاحن وافصل الشاحن من التيار.

### تغيير صوت نغمة اكتمال الشحن

1. قم بإدخال خرطوشة البطارية في منفذ الشحن الذي تود تغيير صوت نغمة اكتمال الشحن الخاصة به. سيصدر صوت آخر النغمات القصيرة مسبقة الضبط الخاصة باكتمال الشحن.
2. نزعها وإعادة إدخالها في غضون خمس ثوان بعد هذا الإجراء يجعل صوت النغمة يتغير.
3. كل مرة يتم نزعها أو إعادة إدخالها في غضون خمس ثوان أخرى بعد هذا، يتغير صوت النغمة وفقاً لذلك.
4. عند خروج صوت النغمة المرغوبة، اترك خرطوشة البطارية التي جرى إدخالها وسوف يبدأ الشحن. عند اختيار وضع "صفارة قصيرة"، لا تخرج أي إشارات لاكتمال الشحن (الوضع الصامت)

زمن الشحن (دقائق)	القدرة (أمبير ساعة)	الجهد		
		14.4 فولت	12 فولت	9.6 فولت
20	2.0	—	10	BH9020A
15	2.0	BH1420	BH1220/C	—
30	3.3	—	—	BH9033A
22	3.3	BH1433	BH1233/C	—

زمن الشحن (دقائق)	القدرة (أمبير ساعة) وفقاً لمعيار IEC61960	الجهد			
		18 فولت	14.4 فولت	18 فولت	14.4 فولت
15	1.3	—	—	BL1815	BL1415
22	3.0	BL1830	BL1430/A	—	—
15	1.5	—	—	BL1815N	BL1415NA/BL1415N
24	2.0	—	—	/BL1820 BL1820B	—
36	4.0	/BL1840 BL1840B	BL1440	—	—
45	5.0	/BL1850 BL1850B	BL1450	—	—
55	6.0	BL1860B	—	—	—

### ملاحظة:

- شاحن البطارية مخصص لشحن خرطوشة البطارية Makita. لا تستخدمه أبداً لأغراض أخرى أو لبطاريات من إنتاج شركات أخرى.
  - عند شحن خرطوشة بطارية جديدة أو لم يتم استخدامها لفترة طويلة من الزمن، فقد لا تقبل الشحن الكامل لحين بعد تفريغها تماماً وإعادة شحنها بضع مرات. (بطارية النيكل-هيدريد المعدن فقط)
  - في حالة قد يومض مصباح الشحن باللون الأحمر، تكون حالة البطارية كما يلي وقد لا يبدأ الشحن.
  - خرطوشة البطارية من أداة تم تشغيلها للتلو أو خرطوشة البطارية التي قد تم تركها في مكان معرض لأشعة الشمس المباشرة لمدة طويلة.
- خرطوشة البطارية التي قد تم تركها لمدة طويلة في مكان معرض لهواء بارد.
- عندما تكون خرطوشة البطارية ساخنة جداً، سيبدأ الشحن بعد أن تقوم مروحة التبريد المتبينة في الشاحن بتبريد خرطوشة البطارية. سوف يبدأ الشحن بعد أن تصل درجة حرارة خرطوشة البطارية إلى الدرجة التي يكون عندها الشحن ممكناً.
- في حالة يومض مصباح الشحن باللون الأخضر والأحمر بالتبادل، يكون الشحن غير ممكن. أطراف التوصيل الموجودة على الشاحن أو خرطوشة البطارية مسدودة بالأتربة أو خرطوشة البطارية تالفة أو متضررة.

**تحذير:** يمكن استخدام هذا الجهاز بواسطة الأطفال الذين تتراوح أعمارهم من 8 سنوات فأكثر والأشخاص ذوي القدرات الجسدية أو الحسية أو العقلية المنخفضة أو من تتقصم الخبرة أو المعرفة إذا تم منحهم الإشراف أو التعليمات بشأن استخدام الجهاز بطريقة آمنة ويفهمون المخاطر التي ينطوي عليها. ينبغي على الأطفال عدم اللعب بالجهاز. وينبغي عدم التنظيف أو إجراء صيانة المستخدم بواسطة الأطفال دون إشراف.

الرموز

يوضح التالي الرموز المستخدمة للمعدات. تأكد من أنك تفهم معانيها قبل الاستخدام.

- اقرأ دليل التعليمات. 
- الاستخدام الداخلي فقط. 
- جهاز للشحن. 
- عزل مزدوج. 
- اكتمل الشحن. 
- جاري الشحن. 
- بطارية معبية. 
- تأخير الشحن (تبريد البطارية أو بطارية باردة جدًا). 
- خلل بالتبريد. 
- موائمة. 
- لا تدمر البطارية بواسطة النار. 
- لا تقصر البطاريات. 
- لا تعرض البطارية للماء أو المطر. 
- فقط لنول الاتحاد الأوروبي. 
- لا تتخلص من المعدات الكهربائية أو الإلكترونية والبطاريات والمراكم ونفايات البطاريات مع النفايات المنزلية! 
- احترامًا للتوجيهات الأوروبية، بشأن نفايات المعدات الكهربائية والإلكترونية والبطاريات والمراكم ونفايات البطاريات والمراكم وتنفيذها وفقًا للقوانين الوطنية، يجب تجميع المعدات الكهربائية والبطاريات ومجموعات البطارية التي وصلت لنهاية عمرها بشكل منفصل وإعادتها إلى منشأة إعادة تدوير متوافقة بيئيًا.

1. احتفظ بهذه التعليمات - يحتوي هذا الدليل على تعليمات سلامة وتشغيل هامة لشاحن البطارية.
  2. قبل استخدام شاحن البطارية، اقرأ جميع التعليمات والعلامات التحذيرية الموجودة على (1) شاحن البطارية، (2) البطارية، و (3) المنتج الذي يستخدم البطارية.
  3. تنبيه - لحد من خطر الإصابة، قم فقط بشحن البطاريات القابلة لإعادة الشحن من نوع Makita. الأنواع الأخرى من البطاريات قد تنفجر مسببة إصابة شخصية أو ضرر.
  4. لا يمكن شحن البطاريات غير القابلة لإعادة الشحن باستخدام شاحن البطارية هذا.
  5. استخدم مصدر قدرة بالجهد المحدد على اللافتة الخاصة بالشاحن.
  6. لا تشحن خرطوشة البطارية في وجود سوائل أو غازات ملتهبة.
  7. لا تعرض الشاحن للمطر أو الثلج.
  8. لا تحمل الشاحن مطلقًا من السلك أو تنتزعه بعنف لفصله من المقبس.
  9. بعد الشحن أو قبل محاولة أي صيانة أو تنظيف، افصل الشاحن من مصدر القدرة. اسحب بواسطة المقابس بدلاً من السلك كما قمت بفصل الشاحن.
  10. تأكد من أن السلك موضوع بحيث لا يتم الخطو عليه، أو التعثر فيه، أو بطريقة أخرى معرض للضرر أو الإجهاد.
11. لا تقم بتشغيل شاحن ذو سلك أو قابس متضرر. إذا كان السلك أو القابس متضررًا، اطلب استبداله من مركز خدمة Makita معتمد لتجنب الخطر.
  12. لا تقم بتشغيل أو تفكيك الشاحن إذا كان قد تلقى صدمة قوية، أو تم إسقاطه، أو بطريقة أخرى تضرر بأي شكل من الأشكال؛ خذه إلى فني صيانة مؤهل. قد يؤدي الاستخدام غير الصحيح أو إعادة التجميع إلى خطر الصدمة الكهربائية أو الحريق.
  13. لا تشحن خرطوشة البطارية عندما تكون درجة حرارة الغرفة أقل من 10 درجة مئوية (50 درجة فهرنهايت) أو أعلى من 40 درجة مئوية (104 درجة فهرنهايت). في درجات الحرارة الباردة، قد لا يبدأ الشحن.
  14. لا تحاول استخدام محول رافع للجهد، مولد كهربائي ذو محرك أو مقبس قدرة ذو تيار مستمر.
  15. لا تسمح لأي شيء بتغطية أو سد فتحات الشاحن.
  16. لا تدخل مسامير، سلك، وما إلى ذلك في منفذ USB المخصص بمصدر الطاقة.

**Makita** Jan-Baptist Vinkstraat 2, 3070, Belgium  
**Makita Corporation** Anjo, Aichi, Japan

885372F999

[www.makita.com](http://www.makita.com)

IDE