

## MX round rail set

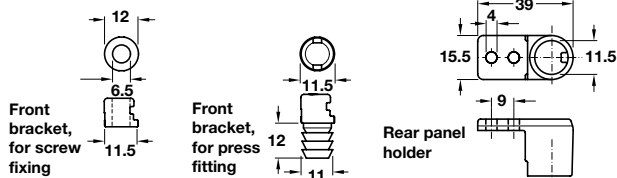

- > Packing/labelling details (553.59-0001):  
 Pair consists of:  
 1x 553.59.903 MX round rail set  
 to be bagged and labelled with:  
 553.59-0001 MX round gallery rail 400 mm grey, 1 pr  
 SKU: 1097V, Barcode: 5017524747750  
 Qty: 1 pr  
 24 prs in a carton, yellow label on carton with:  
 SKU: 1097V MX round gallery rail 400 mm grey, 1 pr  
 Qty. 24 prs  
 Hafele part number on a small white label on the carton
- > Packing/labelling details (553.59-0002):  
 Pair consists of:  
 1x 553.59-0002 MX round rail set  
 to be bagged and labelled with:  
 553.59-0002 MX round gallery rail 450 mm grey, 1 pr  
 SKU: 2498V, Barcode: 5017524747767  
 Qty: 1 pr  
 24 prs in a carton, yellow label on carton with:  
 SKU: 2498V MX round gallery rail 450 mm grey, 1 pr  
 Qty. 24 prs  
 Hafele part number on a small white label on the carton
- > Order qty: 1 set

For drawer length	Grey/Silver
400 mm	553.59-0001
450 mm	553.59-0002

## Nuvola corner pull out shelving unit, white base with chrome rail



- > Installed height per shelf: 150 mm
- > Built in depth: 470 mm
- > For minimum cabinet widths 800 mm
- > 1 guide fixes to carcasses half, 1 guide to base of cabinet, pivoting mechanisms fix to carcass sides
- > Please note: carcass shelf must be installed in cabinet (not included)
- > Trays operate independently
- > Ideal for retro fitting
- > Every set comes complete with fixing materials and fitting instructions
- > Set includes:
  - 2x White melamine wooden shelves with chrome plated wire rail
  - 2x White plastic guides
  - 2x Pivoting mechanisms
- > Special for **Screwfix**
- > Order qty: 1 set

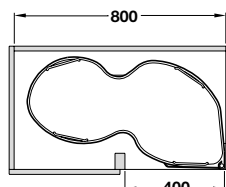

549.42-0020 REPLACED BY  
549.38.296



For cabinet width	800 mm
For door width	400 mm
Unhanded	549.38.296

PAGE AMENDED  
11.12.19

**Wine rack**

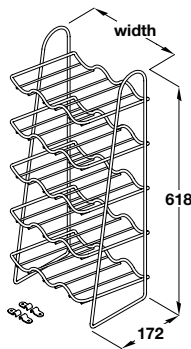

- > Suitable for use in 300 mm wide cabinets
- > Chrome-plated steel
- > Packing/labelling details:  
54194201  
Wire Wine Rack 300 mm (256x618x172mm) Chr  
SKU No. 2584R  
Barcode 5017524123103  
Qty 1
- > Special for **Screwfix**
- > Order qty: 1 pc



For cabinet width	Width	No. of bottles	Cat. No.
300 mm	256 mm	15	541.94.201

**Spice and packet rack, one tier**

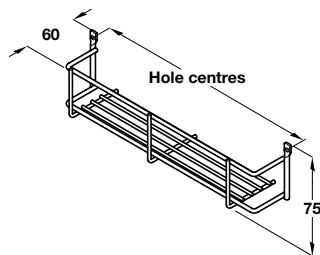
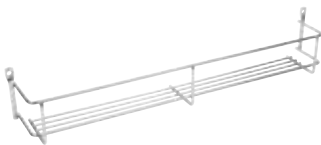

- > Screw fixing
- > Heavier gauge chrome-plated steel
- > Packing/labelling details:  
SKU No. 9273R  
Barcode 5017524123356  
Qty 1
- > Special for **Screwfix**
- > Order qty: 1 pc



Fixing centres	Depth	Linear
400 mm	60 mm	543.12.213

**Cutlery insert, 380-440 mm deep**

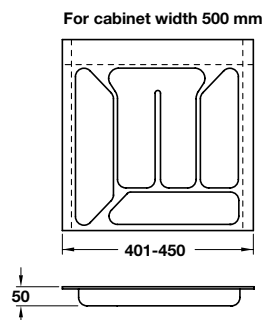

- > For cabinet depth 500 mm
- > For cabinet width 500 mm
- > With a generous border allowance for trimming to size
- > This material is too sturdy to cut with just scissors or a sharp knife
- > 3 mm thick plastic
- > Cream-white vacuum formed plastic
- > Packing/labelling details:  
To be supplied individually polybag and labelled with a white label with: Cutlery insert 500 mm cream white, Ref: 7106R, Barcode: 5017524749655  
25 pieces to be supplied in a outer carton and labelled with a yellow label with: Cutlery insert 500 mm cream white, Ref: 7106R, Qty: 25  
Outer carton to also be labelled with a small white label with: Hafele: 556.85.451, Qty: 25
- > Special for **Screwfix**
- > Order qty: 1 pc

For cabinet width	Cat. No.
500 mm	556.85.451

DATA SHEET 2013, © Häfele U.K. Ltd 2013. Dimensional data not binding. We reserve the right to alter specifications without notice.

## Larder unit and basket sets

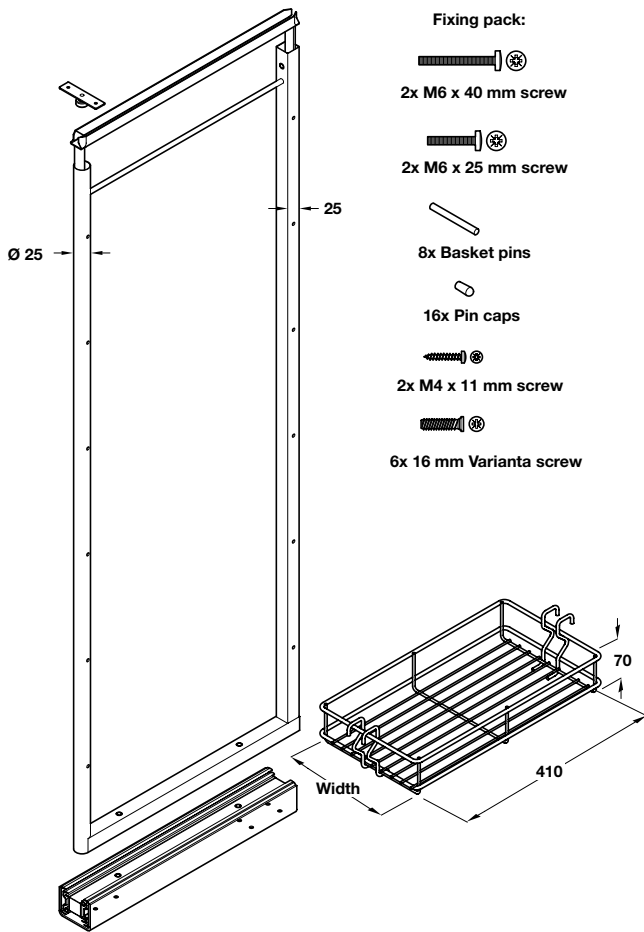

- > Set consists of:
  - 1x 1400-1500 mm 3/4 extension larder unit
  - 4x Chrome baskets 220/520 mm wide
  - 1x Fixing pack
- > Silver painted frame and runners with silver painted baskets
- > Special for **Screwfix**
- > Order qty: 1 set

For cabinet width	Width	Cat. No.
300 mm	220 mm	546.29.231
600 mm	520 mm	546.29.237

## Häfele AXILO™ 78 plinth feet set

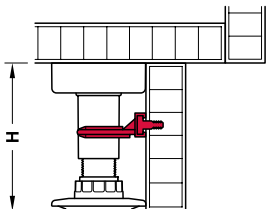
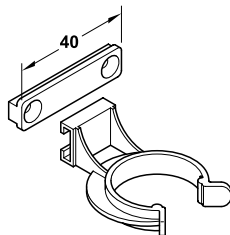
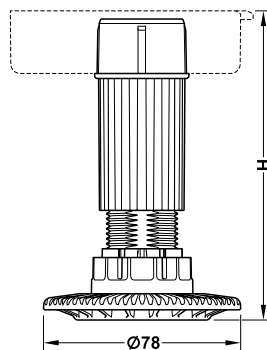
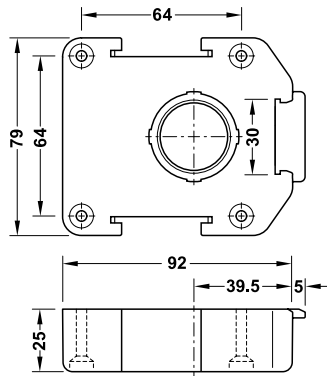

- > For use from installation height 80 mm
- > Height adjustable at the side and from above -10 to +20 mm using AXILO™ adjusting tool
- > Height adjustment facility: Max. 80 kg cabinet weight
- > Load bearing capacity: 150 kg per foot
- > Consists of:
  - 20x 637.76.333 Plinth foot, top section
  - 20x 637.76.355 Foot and shaft section
  - 20x 637.38.054 Plinth panel clips
- > Labelling/package details:
  - 1 set bagged and labelled with Screwfix SKU code 108JY, product description and barcode 5017524758855
  - 10 sets in a box
  - Outer carton to include white label showing our part number and yellow label showing Screwfix SKU code 108JY, description and quantity.
  - Carton 73031-1004 to be used. Carton needs to be cut down to 500 mm, so finished box size is 630 x 570 x 500 mm
- > Black plastic
- > Special for **Screwfix**
- > Order qty: 1 set



Installation	Cat. No.
Screw fixing	637.76.387