

evOLUTION®

evolutionpowertools.com

Original Instructions
Original-Anleitung

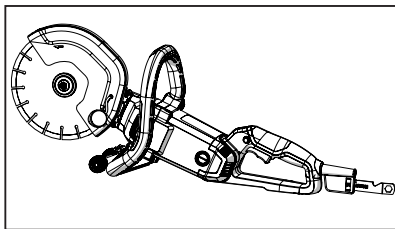

R230

DCT

009-0001, 009-0001X,
009-0002, 009-0002X,
009-0003, 009-0003X,
009-0004, 009-0004X,
009-0006, 009-0006X

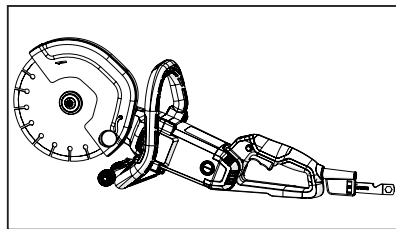

R255

DCT

010-0001, 010-0001X,
010-0002, 010-0002X,
010-0003, 010-0003X,
010-0004, 010-0004X,
010-0006, 010-0006X

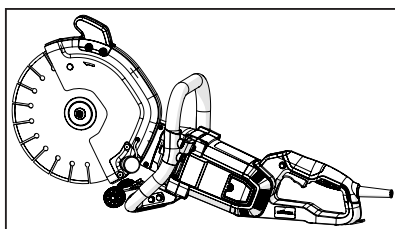

R300

DCT

012-0001, 012-0001X,
012-0002, 012-0002X,
012-0003, 012-0003X,
012-0004, 012-0004X,
012-0006, 012-0006X

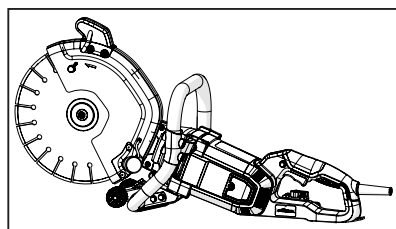

R300

DCT **+**

012-0001A, 012-0001AX,
012-0002A, 012-0002AX,
012-0003A, 012-0003AX,
012-0004A, 012-0004AX,
012-0006A, 012-0006AX



5490



Intertek
5015647



This Instruction Manual was originally written in English.

IMPORTANT

Please read these operating and safety instructions carefully and completely. For your own safety, if you are uncertain about any aspect of using this equipment please access the relevant Technical Helpline, the number of which can be found on the Evolution Power Tools website. We operate several Helplines throughout our worldwide organization, but Technical help is also available from your supplier.

WEB

www.evolutionpowertools.com

Congratulations on your purchase of an Evolution Power Tools Machine. Please complete your product registration 'online' as explained in the A4 online guarantee registration leaflet included with this machine. You can also scan the QR code found on the A4 leaflet with a Smart Phone. This will enable you to validate your machine's guarantee period via Evolutions website by entering your details and thus ensure prompt service if ever needed. We sincerely thank you for selecting a product from Evolution Power Tools.

EVOLUTION LIMITED GUARANTEE.

Evolution Power Tools reserves the right to make improvements and modifications to the product design without prior notice.

Please refer to the guarantee registration leaflet and/or the packaging for details of the terms and conditions of the guarantee.

Evolution Power Tools will, within the guarantee period, and from the original date of purchase, repair or replace any goods found to be defective in materials or workmanship. This guarantee is void if the tool being returned has been used beyond the recommendations in the Instruction Manual or if the machine has been damaged by accident, neglect, or improper service. This guarantee does not apply to machines and / or components which have been altered, changed, or modified in any way, or subjected to use beyond recommended capacities and specifications. Electrical components are subject to respective manufacturers' warranties. All goods returned defective shall be returned prepaid freight to Evolution Power Tools. Evolution Power Tools reserves the right to optionally repair or replace it with the same or equivalent item. There is no warranty – written or verbal – for consumable accessories such as (following list not exhaustive) blades, cutters, drills, chisels or paddles etc. In no event shall Evolution Power Tools be liable for loss or damage resulting directly or indirectly from the use of our merchandise or from any other cause. Evolution Power Tools is not liable for any costs incurred on such goods or consequential damages. No officer, employee or agent of Evolution Power Tools is authorized to make oral representations of fitness or to waive any of the foregoing terms of sale and none shall be binding on Evolution Power Tools.

Questions relating to this limited guarantee should be directed to the company's head office, or call the appropriate Helpline number.

SPECIFICATIONS

MACHINE SPECIFICATIONS	R230DCT		R255DCT		R300DCT		R300DCT+	
Product Code UK/EU/AUS	009-0001, 009-0002, 009-0003, 009-0006,	009-0001X, 009-0002X, 009-0003X, 009-0006X	010-0001, 010-0002, 010-0003, 010-0006,	010-0001X, 010-0002X, 010-0003X, 010-0006X	012-0001, 012-0002, 012-0003, 012-0006,	012-0001X, 012-0002X, 012-0003X, 012-0006X	012-0001A, 012-0002A, 012-0003A, 012-0006A,	012-0001AX, 012-0002AX, 012-0003AX, 012-0006AX
Product Code USA	009-0004	009-0004X	010-0004	010-0004X	012-0004	012-0004X	012-0004A	012-0004AX
Motor EU/UK/AUS (220-240V ~ 50Hz)	2000W		2000W		2400W		2400W	
Motor EU/UK (110V ~ 50Hz)	1600W		1600W		1600W		2000W	
Motor USA (120V ~ 60Hz)	15A		15A		15A		15A	
Rated speed (min ⁻¹)	6000		6000		110V - 4400 120V - 4600 220-240V - 5090		110V - 4400 120V - 4600 220-240V - 5090	
Recommended Max duty cycle	20 mins							
Weight	7.1kg		7.3kg		9.7kg		9.7kg	
Cable length	3m (10ft)		4m (13ft)		4m (13ft)		4m (13ft)	
Cutting capacity at 90°	90mm (3-1/2")		102.5mm (4-1/16")		115mm (4-1/2")		115mm (4-1/2")	
BLADE								
Blade supplied	General Diamond	No Blade Included	Premium Diamond	No Blade Included	General Diamond	No Blade Included	Premium Diamond	No Blade Included
Diameter	230mm (9")		255mm (10")		300mm (12")		300mm (12")	
UK & EU Bore	22.2mm		22.2mm		22.2 / 20mm		22.2 / 20mm	
USA Bore	7/8"		7/8"		1"		1"	
NOISE & VIBRATION DATA								
Sound Pressure Max L _p A	98.0dB(A) K=3dB(A)							
Sound Power Level Max L _w A	109.0dB(A) K=3dB(A)							
Handle Vibration Max Level	6.15m/s ² K=1.5m/s ²							

Note: The vibration measurement was made under standard conditions in accordance with: BS EN 60745-1:2009+A11: 2010

The declared vibration total value has been measured in accordance with a standard test method and may be used for comparing one tool with another.

The declared vibration total value may also be used in a preliminary assessment of exposure.

VIBRATION

WARNING: When using this machine the operator can be exposed to high levels of vibration transmitted to the hand and arm. It is possible that the operator could develop "Vibration white finger disease" (Raynaud syndrome). This condition can reduce the sensitivity of the hand to temperature as well as producing general numbness. Prolonged or regular users of this machine should monitor the condition of their hands and fingers closely.

If any of the symptoms become evident, seek immediate medical advice.

- The measurement and assessment of human exposure to hand-transmitted vibration in the workplace is given in: **BS EN ISO 5349-1:2001 and BS EN ISO 5349-2:2002**
- Many factors can influence the actual vibration level during operation e.g. the work surfaces condition and orientation and the type and condition of the machine being used. Before each use, such factors should be assessed, and where possible appropriate working practices adopted. Managing these factors can help reduce the effects of vibration:

Handling

- Handle the machine with care, allowing the machine to do the work.
- Avoid using excessive physical effort on any of the machines controls.
- Consider your security and stability, and the orientation of the machine during use.

Work Surface

- Consider the work surface material; its condition, density, strength, rigidity and orientation.

WARNING: The vibration emission during actual use of the power tool can differ from the declared total value depending on the ways in which the tool is used. The need to identify safety measures and to protect the operator are based on an estimation of exposure in the actual conditions of use (taking account of all parts of the operating cycle, such as the times the tool is switched off, when it is running idle, in addition to trigger time).

LABELS & SYMBOLS

WARNING: Do not operate this machine if warning and/or instruction labels are missing or damaged. Contact Evolution Power Tools for replacement labels.

Note: All or some of the following symbols may appear in the manual or on the product.

SYMBOL	DESCRIPTION
V	Volts
A	Amperes
Hz	Hertz
Min ⁻¹	Speed
~	Alternating Current
n	Rated Speed
	Warning!
	Read Instructions
	Dry Cutting Only <i>Only applicable to R230DCT, R255DCT & R300DCT models. Excludes R300DCT+.</i>
	Wear Safety Goggles
	Wear Ear Protection
	Wear Dust Protection
	Wear Head protection
	Wear Safety Gloves
	Wear Safety Boots
	Keep Hands away. Do not place your hand on or below the line marked with this symbol on the front handle. Ensure hand is kept above the line & symbol at all times to ensure a safe distance between your hand and the blade. Failure to do so may cause injury. <i>Applicable to R230DCT & R255DCT</i>
	US Certification
	CE Certification
	Regulatory Compliance Mark (RCM) for electrical and electronic equipment. Australian/New Zealand Standard.
	GS Certification
	Waste Electrical & Electronic Equipment
	Only use diamond blades, do not use toothed blades
	Don't use defected or broken blades
	High risk of kickback
	Risk of dust inhalation
	Risk of Fire. Ensure surrounding area is free from flammable materials.

INTENDED USE OF THIS POWER TOOL

This machine and has been designed to be used with Evolution blades. Only use accessories designed for use with this machine and/or those recommended specifically by Evolution Power Tools Ltd.

When fitted with an appropriate blade this machine can be used to cut:

Brick
Paving
Kerb Stones
Concrete and related construction materials
Steel
Non-Ferrous metals
Natural Stone

PROHIBITED USE OF THIS POWER TOOL

WARNING: This product is a Hand Operated Concrete Saw and must only be used as such. It must not be modified in any way, or used to power any other equipment or drive any other accessories other than those mentioned in this Instruction Manual.

WARNING: This machine must not be used to cut any material that may contain asbestos. If the presence of asbestos is suspected, consult the relevant authorities for advice.

WARNING: This machine is not intended for use by persons (including children) with reduced physical, sensory or mental capabilities. Potential operators who lack experience concerning the use of this equipment should be given training and be supervised by a competent person who is fully conversant with the working practices necessary to use this equipment safely. Children should be supervised to ensure that they do not have access to, and are not allowed to play with this machine.

RESIDUAL RISKS

Even if the machine is used & maintained correctly, there are still residual risks that could cause serious injury. Due to the type and nature of this machine, the following potential hazards can occur:

- Contact with the exposed blade (cut)
- Reaching into the rotating blade (cut)
- Parts of the blade being thrown from the machine (cut or blunt injury)
- Parts of the workpiece being thrown from the cut (cut or blunt injury)
- Risk of fire from flying sparks
- Damage to hearing if effective hearing protection is not worn (hearing loss)
- Inhalation of dust particles from the workpiece

- Electric shock when touching uninsulated electrical components.

If the instructions contained in this manual are not followed, other residual risks may arise due to improper use.

ELECTRICAL SAFETY

This machine is fitted with the correct moulded plug and mains lead for the designated market. If the supply cord of this power tool is damaged, it must be replaced by a specially prepared cord available through the service organisation. The plug, if damaged, should only be replaced with genuine Evolution replacement parts and be fitted by a competent technician.

(2.1) GENERAL POWER TOOL SAFETY INSTRUCTIONS

(These General Power Tool Safety Instructions are as specified in EN 60745-1: 2009+A11: 2010)

WARNING: Read all safety warnings and instructions. Failure to follow the warnings and instructions may result in electric shock, fire and/or serious injury.

Save all warnings and instructions for future reference. The term "power tool" in the warnings refers to your mains-operated (corded) power tool or battery-operated (cordless) power tool.

(2.2) 1) General Power Tool Safety Warnings [Work area safety]

a) Keep work area clean and well lit. Cluttered or dark areas invite accidents.

b) Do not operate power tools in explosive atmospheres, such as in the presence of flammable liquids, gasses or dust.

Power tools create sparks which may ignite the dust or fumes.

c) Keep children and bystanders away while operating power tool. Distractions can cause you to lose control.

(2.3) 2) General Power Tool Safety Warnings [Electrical Safety]

a) Power tool plugs must match the outlet. Never modify the plug in any way.

Do not use any adapter plugs with earthed (grounded) power tools.

Unmodified plugs and matching outlets will reduce the risk of electric shock.

b) Avoid body contact with earthed or grounded surfaces, such as pipes, radiators, ranges and refrigerators. There is an increased risk of electric shock if your body is earthed or grounded.

c) Do not expose power tools to rain or wet conditions. Water entering a power tool will increase the risk of electric shock.

d) Do not abuse the cord. Never use the cord for carrying, pulling or unplugging the power tool. Keep cord away from heat, oil, sharp edges or moving parts. Damaged or entangled cords increase the risk of electric shock.

e) When operating a power tool outdoors, use an extension cord suitable for outdoor use. Use of a cord suitable for outdoor use reduces the risk of electric shock.

f) If operating a power tool in a damp location is unavoidable, use a residual current device (RCD) protected supply. Use of an RCD reduces the risk of electric shock.

(2.4) 3) General Power Tool Safety Warnings [Personal Safety].

a) Stay alert, watch what you are doing and use common sense when operating a power tool. Do not use a power tool while you are tired or under the influence of drugs, alcohol or medication. A moment of inattention while operating power tools may result in serious personal injury.

b) Use personal protective equipment. Always wear eye protection. Protective equipment such as dust masks, non-skid safety shoes, hard hat or hearing protection used for appropriate conditions will reduce personal injuries.

c) Prevent unintentional starting. Ensure the switch is in the off-position before connecting to power source and or battery pack, picking up or carrying the tool. Carrying power tools with your finger on the switch or energising the power tools that have the switch on invites accidents.

d) Remove any adjusting key or wrench before turning the power tool on.

A wrench or key left attached to a rotating part of a power tool may result in personal injury.

e) Do not overreach. Keep proper footing and balance at all times. This enables better control of the power tool in unexpected situations.

f) Dress properly. Do not wear loose clothing or jewellery. Keep your hair, clothing and gloves away from moving parts. Loose clothes, jewellery or long hair can be caught in moving parts.

g) If devices are provided for the connection of dust extraction and collection facilities, ensure that these are connected and properly used. Use of dust collection can reduce dust-related hazards.

(2.5) 4) General Power Tool Safety Warnings [Power tool use and care].

a) Do not force the power tool. Use the correct power tool for your application. The correct power tool will do the job better and safer at a rate for which it was designed.

b) Do not use the power tool if the switch does not turn it on or off. Any power tool

that cannot be controlled with the switch is dangerous and must be repaired.

c) Disconnect the power tool from the power source and/or battery pack from the power tool before making any adjustments, changing accessories, or storing power tools. Such preventative safety measures reduce the risk of starting the power tool accidentally.

d) Store idle power tools out of the reach of children and do not allow persons unfamiliar with the power tool or these instructions to operate the power tool. Power tools are dangerous in the hands of untrained users.

e) Maintain power tools. Check for misalignment or binding of moving parts, breakage of moving parts and any other condition that may affect the power tools operation. If damaged, have the power tool repaired before use. Many accidents are caused by poorly maintained power tools.

f) Keep cutting tools sharp and clean. Properly maintained cutting tools with sharp cutting edges are less likely to bind and are easier to control.

g) Use the power tool, accessories and tool bits etc. in accordance with these instructions, taking into account the working conditions and the work to be performed. Use of the power tool for operations different from those intended could result in a hazardous situation.

(2.6) 5) General Power Tool Safety Warnings [Service]

a) Have your power tool serviced by a qualified repair person using only identical replacement parts. This will ensure that the safety of the power tool is maintained.

Cut-off machine safety warnings

a) The guard provided with the tool must be securely attached to the power tool and positioned for maximum safety, so the least amount of wheel is exposed towards the operator. Position yourself and bystanders away from the plane of the rotating wheel. The guard helps to protect operator from broken wheel fragments and accidental contact with wheel.

b) Use only bonded reinforced or diamond cut-off wheels for your power tool. Just because an accessory can be attached to your power tool, it does not assure safe operation.

c) The rated speed of the accessory must be at least equal to the maximum speed marked on the power tool. Accessories running faster than their rated speed can break and fly apart.

d) Wheels must be used only for recommended applications. For example: do not grind with the side of cut-off wheel. Abrasive cut-off wheels are intended for peripheral

grinding, side forces applied to these wheels may cause them to shatter.

e) Always use undamaged wheel flanges that are of correct diameter for your selected wheel. Proper wheel flanges support the wheel thus reducing the possibility of wheel breakage.

f) Do not use worn down reinforced wheels from larger power tools. Wheels intended for a larger power tool are not suitable for the higher speed of a smaller tool and may burst.

g) The outside diameter and the thickness of your accessory must be within the capacity rating of your power tool. Incorrectly sized accessories cannot be adequately guarded or controlled.

h) The arbour size of wheels and flanges must properly fit the spindle of the power tool. Wheels and flanges with arbour holes that do not match the mounting hardware of the power tool will run out of balance, vibrate excessively and may cause loss of control.

i) Do not use damaged wheels. Before each use, inspect the wheels for chips and cracks. If power tool or wheel is dropped, inspect for damage or install an undamaged wheel. After inspecting and installing the wheel, position yourself and bystanders away from the plane of the rotating wheel and run the power tool at maximum no load speed for one minute. Damaged wheels will normally break apart during this test time.

j) Wear personal protective equipment. Depending on application, use face shield, safety goggles or safety glasses. As appropriate, wear dust mask, hearing protectors, gloves and shop apron capable of stopping small abrasive or workpiece fragments. The eye protection must be capable of stopping flying debris generated by various operations. The dust mask or respirator must be capable of filtrating particles generated by your operation. Prolonged exposure to high intensity noise may cause hearing loss.

k) Keep bystanders a safe distance away from work area. Anyone entering the work area must wear personal protective equipment. Fragments of workpiece or of a broken wheel may fly away and cause injury beyond immediate area of operation.

l) Hold the power tool by insulated gripping surfaces only, when performing an operation where the cutting accessory may contact hidden wiring or its own cord. Cutting accessory contacting a "live" wire may make exposed metal parts of the power tool "live" and could give the operator an electric shock.

m) Position the cord clear of the spinning accessory. If you lose control, the cord may be cut or snagged and your hand or arm may be

pulled into the spinning wheel.

n) Never lay the power tool down until the accessory has come to a complete stop.

The spinning wheel may grab the surface and pull the power tool out of your control.

o) Do not run the power tool while carrying it at your side. Accidental contact with the spinning accessory could snag your clothing, pulling the accessory into your body.

p) Regularly clean the power tool's air vents. The motor's fan will draw the dust inside the housing and excessive accumulation of powdered metal may cause electrical hazards.

q) Do not operate the power tool near flammable materials. Sparks could ignite these materials.

r) Do not use accessories that require liquid coolants. Using water or other liquid coolants may result in electrocution or shock.

Kickback and related warnings

Kickback is a sudden reaction to a pinched or snagged rotating wheel. Pinching or snagging causes rapid stalling of the rotating wheel which in turn causes the uncontrolled power tool to be forced in the direction opposite of the wheel's rotation at the point of the binding. For example, if an abrasive wheel is snagged or pinched by the workpiece, the edge of the wheel that is entering into the pinch point can dig into the surface of the material causing the wheel to climb out or kick out. The wheel may either jump toward or away from the operator, depending on direction of the wheel's movement at the point of pinching. Abrasive wheels may also break under these conditions. Kickback is the result of power tool misuse and/or incorrect operating procedures or conditions and can be avoided by taking proper precautions as given below.

a) Maintain a firm grip on the power tool and position your body and arm to allow you to resist kickback forces. Always use auxiliary handle, if provided, for maximum control over kickback or torque reaction during start-up. The operator can control torque reactions or kickback forces, if proper precautions are taken.

b) Never place your hand near the rotating accessory. Accessory may kickback over your hand.

c) Do not position your body in line with the rotating wheel. Kickback will propel the tool in direction opposite to the wheel's movement at the point of snagging.

d) Use special care when working corners, sharp edges etc. Avoid bouncing and snagging the accessory. Corners, sharp edges or bouncing have a tendency to snag the rotating accessory and cause loss of control or kickback.

e) Do not attach a saw chain, woodcarving blade, segmented diamond wheel with a peripheral gap greater than 10 mm or toothed saw blade. Such blades create frequent kickback and loss of control.

f) Do not “jam” the wheel or apply excessive pressure. Do not attempt to make an excessive depth of cut. Overstressing the wheel increases the loading and susceptibility to twisting or binding of the wheel in the cut and the possibility of kickback or wheel breakage.

g) When wheel is binding or when interrupting a cut for any reason, switch off the power tool and hold the power tool motionless until the wheel comes to a complete stop. Never attempt to remove the wheel from the cut while the wheel is in motion otherwise kickback may occur. Investigate and take corrective action to eliminate the cause of wheel binding.

h) Do not restart the cutting operation in the workpiece. Let the wheel reach full speed and carefully re-enter the cut. The wheel may bind, walk up or kickback if the power tool is restarted in the workpiece.

i) Support panels or any oversized workpiece to minimize the risk of wheel pinching and kickback. Large workpieces tend to sag under their own weight. Supports must be placed under the workpiece near the line of cut and near the edge of the workpiece on both sides of the wheel.

j) Use extra caution when making a “pocket cut” into existing walls or other blind areas. The protruding wheel may cut gas or water pipes, electrical wiring or objects that can cause kickback.

(2.7) HEALTH ADVICE

WARNING: When using this machine, dust particles may be produced. In some instances, depending on the materials you are working with, this dust can be particularly harmful. If you suspect that paint on the surface of material you wish to cut contains lead, seek professional advice. Lead based paints should only be removed by a professional and you should not attempt to remove it yourself. Once the dust has been deposited on surfaces, hand to mouth contact can result in the ingestion of lead. Exposure to even low levels of lead can cause irreversible brain and nervous system damage. The young and unborn children are particularly vulnerable.

You are advised to consider the risks associated with the materials you are working with and to reduce the risk of exposure. As some materials can produce dust that may be hazardous to your health, we recommend the use of an approved face mask with replaceable filters when using this machine.

You should always:

- Work in a well-ventilated area.
- Work with approved safety equipment, such as dust masks that are specially designed to filter microscopic particles.

(2.8) WARNING: the operation of any power tool can result in foreign objects being thrown towards your eyes, which could result in severe eye damage. Before beginning power tool operation, always wear safety goggles or safety glasses with side shield or a full face shield where necessary.

ADDITIONAL SAFETY INSTRUCTIONS

WARNING: Always disconnect the Concrete Cutting Saw from the mains supply before cleaning, carrying out maintenance or changing blades.

- **Keep your hands away from cutting area or the blade.** If both your hands are holding the machines handles, they cannot come into contact with the diamond cutting blade.
- **Never engage the spindle lock button while the machine is running.** Serious damage could occur to the machine and a potentially dangerous situation could arise for the operator.
- **Only use cutting blades or other approved cutting blades as specified by the manufacturer.**
- **Visually check the cutting blade before starting the machine.** If it is cracked, broken or bent, do not use it. Carefully start the machine and check for any unusual noises, vibration or other abnormalities.
- **Be careful when cutting metal.** Using the diamond blade to cut metal (reinforcing rods embedded in concrete) will shorten its service life. Use a specialist metal cutting blade where possible.
- **Allow the cutting blade to reach full speed before beginning a cut.** Start working only when maximum speed is reached.
- **Do not use excessive force.** Excessive force overloads the motor and reduces working efficiency and service life.
- **Only cut concrete, tile or stone to a maximum cutting depth of 50mm or less.** If the cutting depth ultimately required is greater than 50mm, cut the workpiece 2 or 3 times. If a cutting depth of more than 50mm is attempted in one pass the service life of the cutting blade could be reduced and motor damage occur.
- **Install the dust extraction port cover when a dust collection hose is not in use.** During cutting operations sparks could be generated. Cover the dust extraction port with its rubber cap and be sure to wear protective glasses.
- **Never use a damaged or incorrect arbor bolt or blade flanges.** The blade flanges

and arbor bolt were specially designed for your machine and will provide optimum performance during cutting operations.

- **This machine is fitted with the correct moulded plug and mains lead for the intended country of use.** Do not alter or modify the mains cable or plug in any way. If the mains lead or the plug are damaged in any way, they must be replaced with original replacement parts by a competent technician.
- **Where possible always use a method of dust control when cutting concrete, either Dust extraction or water suppression where applicable.** When using dust extractors with Evolution Disc Cutters ensure these are rated as Class M or Class H when cutting concrete.

WARNING: This machine must not be used to cut any material that may contain asbestos. If the presence of asbestos is suspected, consult the relevant authorities for advice.

PPE (Personal Protective Equipment)

Note: If using this equipment on a construction site it is important that the operator conforms to any site rules/regulations that may apply. Consult the site foreman or other responsible person for details.

- **Wear suitable clothing.** This could include a Boiler Suit or Padded Coverall and Hi Vis jacket etc.
- **Wear suitable footwear.** Safety shoes with steel toe caps and anti-slip soles are recommended.
- **Wear suitable Safety Glasses.** A Full Face Safety Shield or Safety Goggles with side shields is recommended.
- **Protect your hearing.** Wear suitable ear protectors.
- **Wear suitable gloves.** High grip gloves are recommended.
- **Wear respiratory protection.** A dust mask with replaceable filters which provide protection against fine toxic dust, fibres and vapours is recommended.
- **Wear a Safety Helmet.** The use of a Safety Hat may be compulsory on some construction sites to protect the operator from potential overhead dangers.

(4.1) GETTING STARTED - UNPACKING

Caution: This packaging contains sharp objects. Take care when unpacking. Remove the machine, together with the accessories supplied from the packaging. Check carefully to ensure that the machine is in good condition and account for all the accessories listed in this manual. Also make sure that all the accessories are complete. If any parts are found to be missing, the machine and its accessories should

be returned together in their original packaging to the retailer. Do not throw the packaging away; keep it safe throughout the guarantee period. Dispose of the packaging in an environmentally responsible manner. Recycle if possible. Do not let children play with empty plastic bags due to the risk of suffocation.

(4.2) ITEMS SUPPLIED

DESCRIPTION	QUANTITY
Instruction Manual	1
Blade *	1
Multi-tool (Adjustments)	1
Wheeled Undercarriage	1
Rubber Cap (extraction port)	1
Hose Connector (R300DCT+)	1

* Some models supplied with no blade. See specification table for details.

(4.3) ADDITIONAL ACCESSORIES

In addition to the standard items supplied with this machine the following accessories are also available from the Evolution online shop at www.evolutionpowertools.com or from your local retailer.

(4.4)

DESCRIPTION	PART NO
Specialist cutting blades are available	Consult the Evolution Helpline for further information and details
Hand pump water bottle	Consult the Evolution Helpline for further information and details
Foot pump water bottle	Consult the Evolution Helpline for further information and details
Carry Case	Consult the Evolution Helpline for further information and details
Dust port adaptors	Consult the Evolution Helpline for further information and details
Wet cut kit (to convert R300DCT)	Consult the Evolution Helpline for further information and details

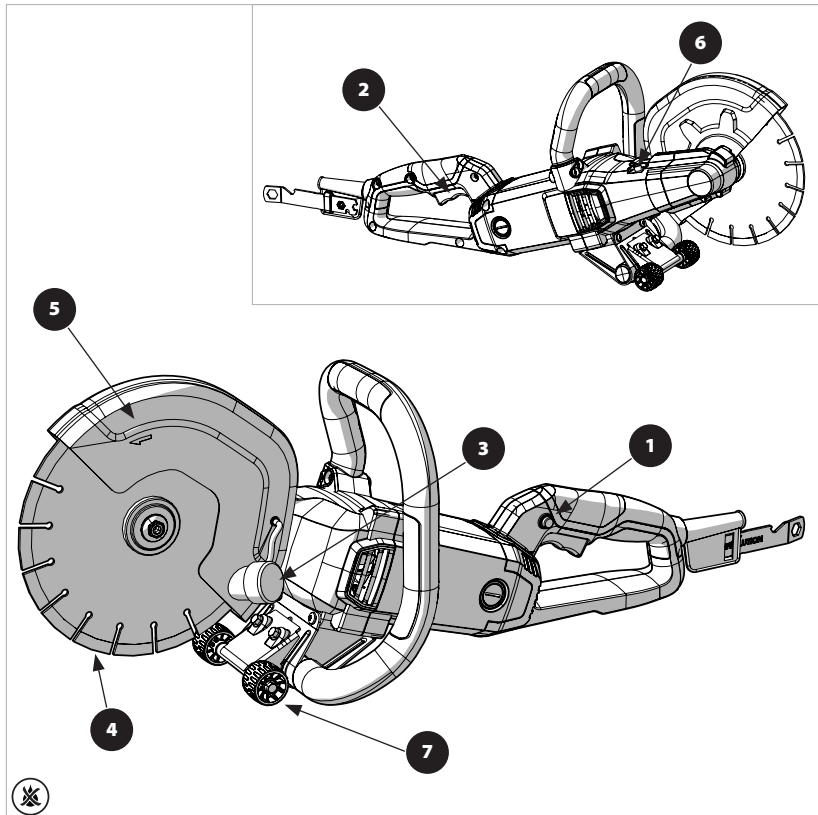
MACHINE OVERVIEW R230DCT

1. Safety Lock Button

2. Trigger Switch

3. Dust Extraction Port

4. Cutting Disc

5. Blade Guard

6. Arbor Lock Button

7. Wheeled undercarriage

MACHINE OVERVIEW R255DCT

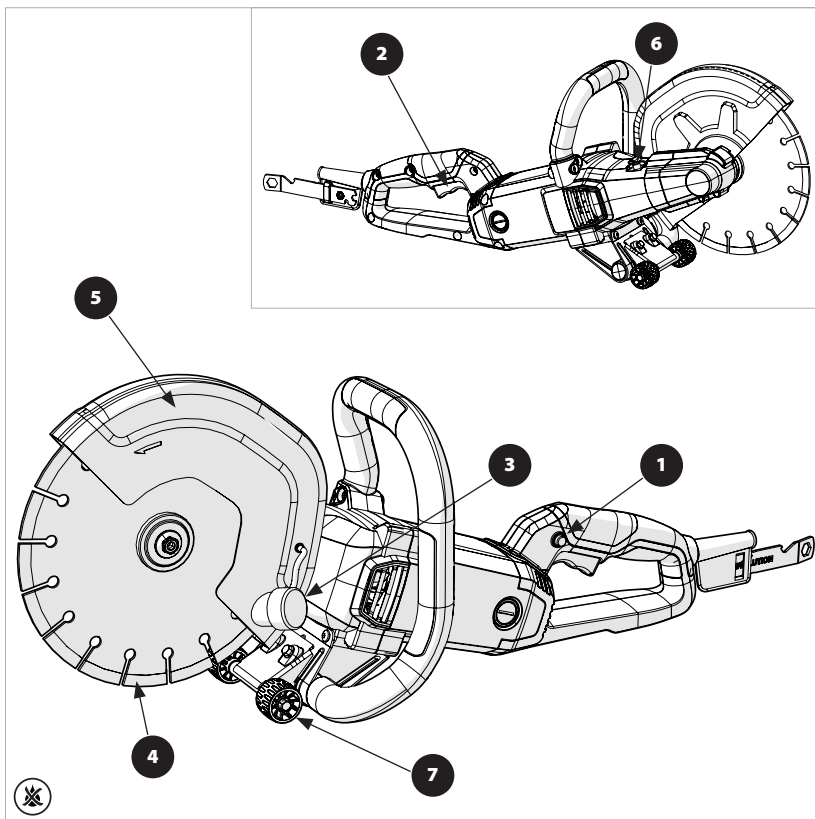

1. Safety Lock Button

2. Trigger Switch

3. Dust Extraction Port

4. Cutting Disc

5. Blade Guard

6. Arbor Lock Button

7. Wheeled undercarriage

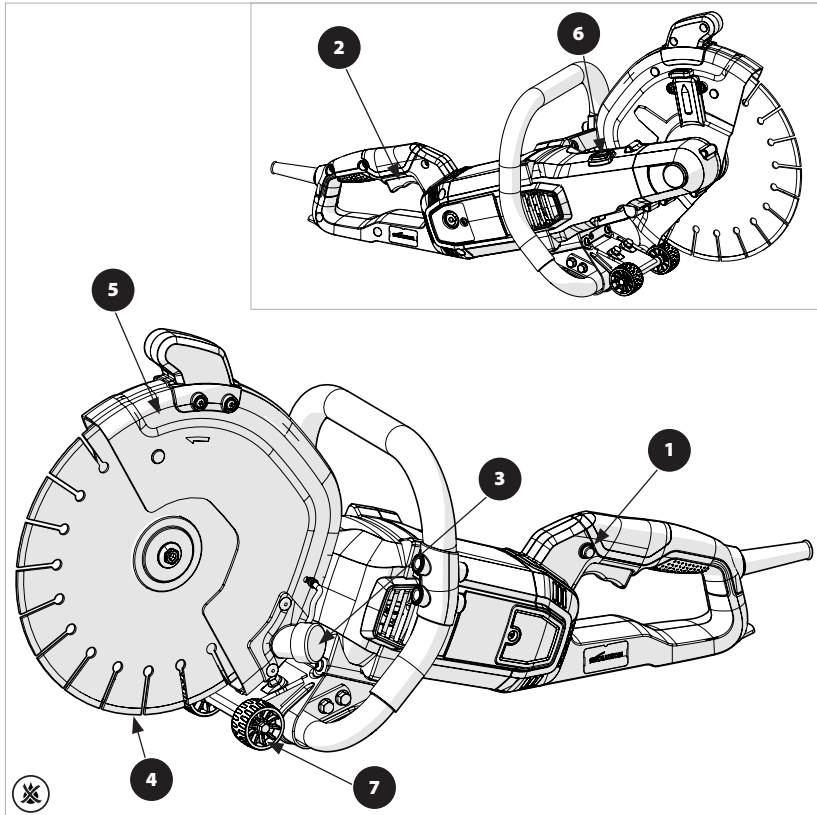
MACHINE OVERVIEW R300DCT

1. Safety Lock Button

2. Trigger Switch

3. Dust Extraction Port

4. Cutting Disc

5. Adjustable Blade Guard

6. Arbor Lock Button

7. Wheeled undercarriage

MACHINE OVERVIEW R300DCT+

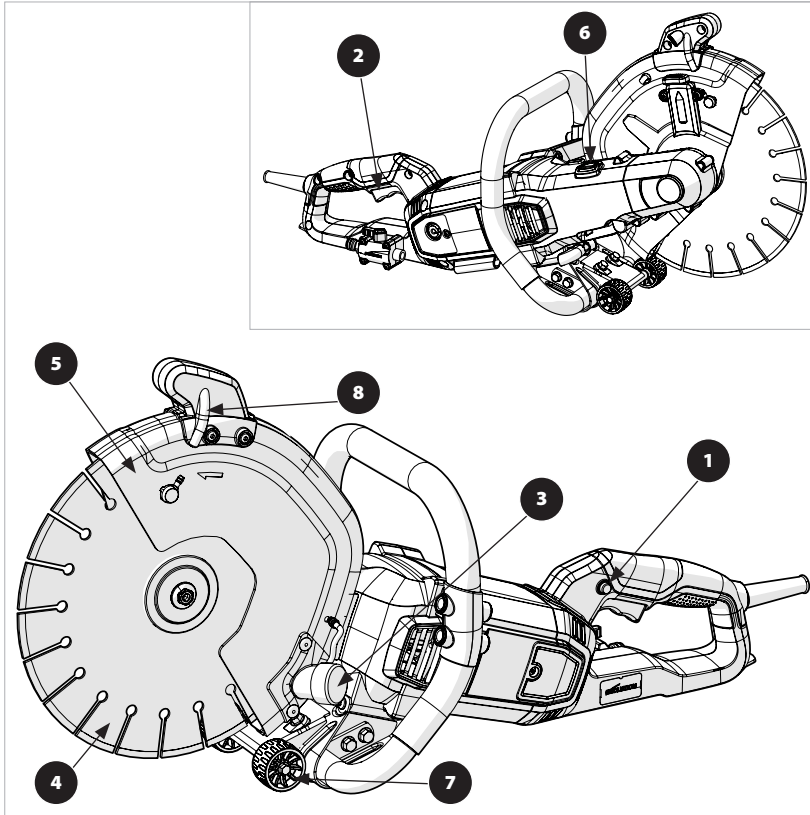

1. Safety Lock Button

2. Trigger Switch

3. Dust Extraction Port

4. Cutting Disc

5. Adjustable Blade Guard

6. Arbor Lock Button

7. Wheeled undercarriage

8. Water feed

GENERAL DESCRIPTION

Evolution Concrete Cutting Saws have been designed to incorporate many unique & time saving design features. Some of these features are shared across the range. Refer to the Specification section of this Instruction Manual to identify the specific features found on any particular machine.

Shared Features:

- Safety Start ON/OFF Trigger Switch
- Widely spaced ergonomic front and rear handles which provide enhanced operator control and aid safety.
- Optimum weight balance between the front and rear handles promotes comfort and reduces operator fatigue.
- Front and rear handles electrically insulated from the machines metal parts.
- Dust extraction capability.
- Quality rubber sheathed power cable.
- Reinforced Steel Skid Plate.
- Removable wheeled undercarriage.
- Multi-purpose adjustment tool
- On board Tool Storage
- Replaceable motor brushes

Note: Where necessary machine specific features are referred to throughout this Manual.

BLADE FLANGES

USA: Machines destined for the USA market are supplied with blade flanges which accommodate blades with an arbor hole of $\varnothing 25.4\text{mm}$ ($\varnothing 1"$) for 12" blades, and $\varnothing 22.2$ ($\varnothing 7/8"$) arbor hole for 9 & 10" blades.

OTHER MARKETS: Other machines are supplied with blade flanges that can accommodate blades with either a $\varnothing 20\text{mm}$ ($\varnothing 3/4"$) or $\varnothing 22.2$ ($\varnothing 7/8"$) arbor hole depending upon how the flanges are installed.

INSTALLING A CUTTING BLADE. (Ø20mm Ø22.2mm and Ø25.4mm bore blades)

WARNING: Always disconnect the machine from the power supply before attempting to install or remove a blade.

- Ensure that the machines arbor and the blade flanges are clean and free from any dust or debris.
- Ensure that the direction of rotation marked on the blade matches the direction of rotation marked on the machines guard.
- Install blade flange (a) on the inner side of the blade. (Fig. 1)
- Install the blade with reference to the direction of rotation arrows.
- Install the outer blade flange (b) and insert the arbor bolt (c) into the machines arbor, for your appropriate machine. (Fig. 1)

All Machines:

- Press the arbor lock to lock the machines arbor. (Fig. 2)
- Tighten the arbor bolt using the supplied multi-tool. (Fig. 3)
- Release the arbor lock.
- Carefully rotate the blade by hand and check that it is secure, correctly positioned on the blade flanges and that it rotates freely.

REMOVING A CUTTING BLADE (All Evolution Machines)

- Press the arbor lock to lock the machines arbor.
- Loosen and remove the arbor bolt using the supplied multi-tool.
- Withdraw the outer washer and blade flange.
- Remove the blade.
- If necessary remove the inner blade flange for inspection and/or cleaning.

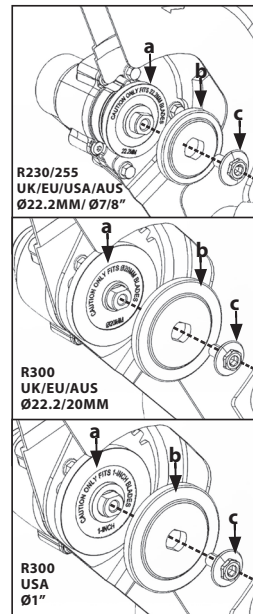

FIG. 1

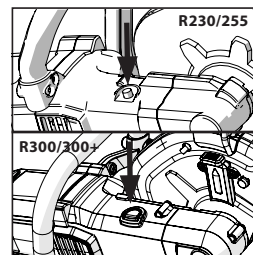

FIG. 2

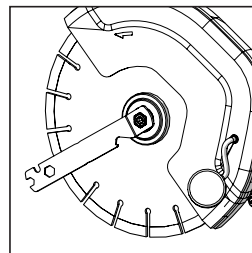

FIG. 3

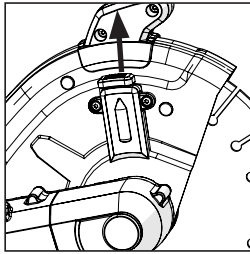

FIG. 4

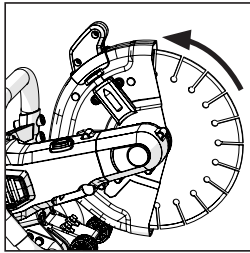

FIG. 5

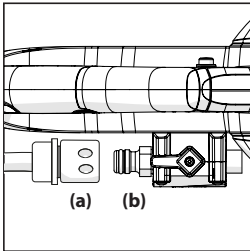

FIG. 6a & b

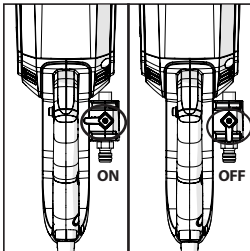

FIG. 6c

**ADJUSTABLE BLADE GUARD
(R300 DCT+ and R300 DCT)**

The blade guard on these machines is adjustable. It should be positioned to provide the operator with the best combination of personal protection and visibility of the cutting line.

Note: Machines R255 DCT and R230 DCT are equipped with fixed blade guards.

To adjust the Blade Guard:

WARNING: Disconnect the machine from the power supply before repositioning the blade guard.

- Operate the blade guard locking system by pulling the locking pin upwards. **(Fig. 4)**
- Rotate the blade guard to the optimum position using the blade guard rotation handle. **(Fig. 5)**
- Release the locking pin.
- Check the security of the blade guard.

**DUST SUPPRESSION SYSTEM
(Machine R300 DCT+)**

R300 DCT+ is fitted with a dust suppression system. This system will deliver a jet of water at equal pressure and volume to both sides of the blade.

Note: R300 DCT is pre-prepared and can be retro fitted with the dust suppression system. Contact your supplier or access the Evolution Helpline for further details.

To use the dust suppression system:

- Connect a hose from a water supply to the saw, the water supply could be a mains water tap or an Evolution Water Bottle system.
- Push the hose connector **(Fig. 6a)** on to the Water Valve hose adaptor **(Fig. 6b)** there will be a click and the hose connector will be secured.
- Once connected to the water supply pressurise the water either by pumping the bottle or turning on the mains tap.
- Open the water valve to feed water to the blade. The rate of flow can be adjusted by the water valve on the saw. **(Fig. 6c)**
- After finishing the cut, switch off the machine, turn the water valve (3) off to stop flow of water to the blade.
- Disconnect the saw from the water supply by pushing back the hose connector release collar.

Note: Adjust the system so that just enough water is supplied to adequately suppress the dust created by the cutting process.

WARNING: Ensure that any hose supplying water to the machine is of a suitable length. Hoses should be routed in such a way as not to pose a trip or any other form of hazard.

WARNING: Keep liquid away from the tool and any people in the working area.

Note: The Maximum permitted pressure of the liquid supply is 5.5 BAR.

Note: When not in use drain the hose of any residual water. Keep the tank and parts clean and free of debris.

A Residual Current Device (RCD) is fitted to the R300DCT+ for RCD operation please follow these instructions:

- When plugging the saw in the RCD will need to be reset before the saw will power on.
- Plug the saw in, press the reset button on the RCD, there will be a click. **(Fig. 7a)**
- The indicator window will change to RED to show the power is on. **(Fig. 7b)**
- To test, press the TEST button. Again, there will be a click and the indicator window will switch to black showing the power is off. **(Fig. 7c)**
- Press the reset button again to reset and use the saw.

Note: If the RCD trips during use, simply press RESET.

**TWIN WHEELED UNDERCARRIAGE
(All Evolution machines)**

A twin wheeled undercarriage **(Fig. 8)** is supplied with all machines. When fitted **(Fig. 9)** this can provide useful extra stability (and operator comfort) particularly when cutting horizontally and at ground level. It will also ensure that the cutting blade does not touch the ground surface etc when the machine is laid down to rest between cuts.

To fit the Undercarriage:

- Insert the hooks **(Fig 8a)** into the slots on the underside of the Skid Plate.
- Use the supplied undercarriage bolts to secure the carriage to the machine. **(Fig. 10)**

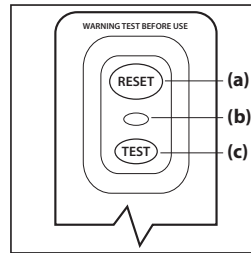

FIG. 7

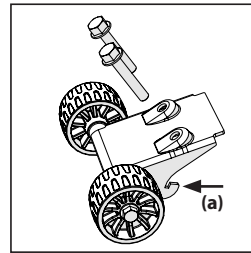

FIG. 8

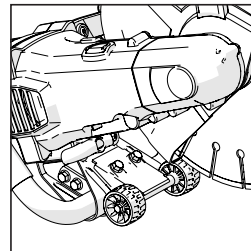

FIG. 9

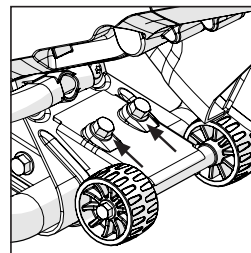

FIG. 10

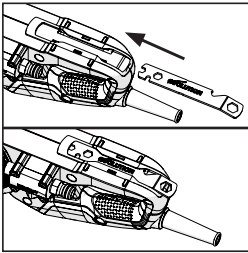

FIG. 11

ON BOARD TOOL STORAGE.

All Evolution machines are provided with on-board storage for the supplied multi-tool.

R300 DCT+ and R300 DCT

Storage provision is located under the machines handle. (Fig. 11)

R225 DCT and R230 DCT

Storage is provided by the sleeve incorporated into the mains cable reinforcement grommet. (Fig.12)

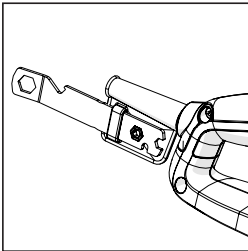

FIG. 12

**CONNECTING A DUST EXTRACTION MACHINE.
(All Evolution machines)**

WARNING: Dust can be very dangerous. We strongly recommend that a suitable dust extraction machine (not supplied) is used with these machines to keep the workplace as clean and safe as possible.

The connection hose of the dust extraction machine should be attached to the dust extraction port of the Blade Guard.

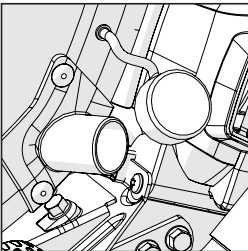

FIG. 13

- Remove the rubber cap from the dust extraction port (Fig. 13) and safely store it for future reinstallation.
- Push the connection hose from the extraction machine onto the extraction port using an appropriate adaptor. (Fig. 14)
- Follow the instructions supplied with the dust extraction machine.
- Ensure that the hose and power cable of an attached dust extraction machine do not pose a trip or any other form of hazard.
- When the dust extraction machine is no longer required, remove it from the Concrete Cutting Saw and replace the rubber cap to the dust extraction port.

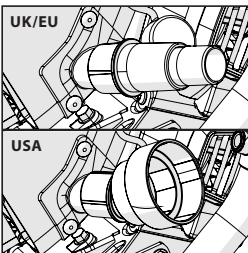

FIG. 14

NOTE: When using dust extractors with Evolution Disc Cutters ensure these are rated as Class M or Class H when cutting concrete.

**THE ON/OFF TRIGGER SWITCH (Fig. 15)
(All Evolution machines)**

Note: These machines are fitted with a Safety Start Trigger Switch.

To start the machine:

- Push in the safety lock button on the side of the handle with your thumb.
- Depress the main trigger switch to start the motor.

WARNING: Never start the saw with the cutting edge of the cutting blade in contact with the workpiece surface.

CUTTING ADVICE

Note: As Evolution Power Tools has no control of how its equipment may be used, the following guidelines (not exhaustive) are offered to help operators use the equipment safely and efficiently.

PRE-CUTTING CHECKS

- Ensure that the power supply matches the requirements specified on the machines rating plate.
- Ensure that the machines trigger switch is in the 'OFF' position. If the machine were to be connected to a power source with the trigger switch in the 'ON' position, the machine could start operating immediately with the possibility of a serious accident occurring.
- If an extension cable is required it must be of a suitable type for the work environment. If used outdoors it should be waterproof and so labelled.
- The manufacturers instructions should be followed when using an extension cable.
- Route any extension cable so that it does not pose a trip (or any other) hazard to the operator, colleagues or any bystanders

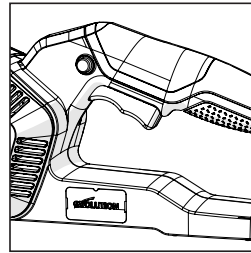

FIG. 15

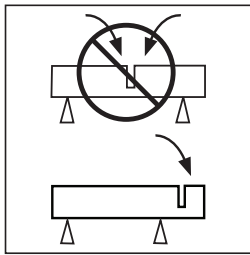

FIG. 16

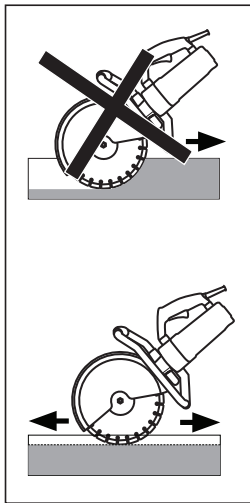

FIG. 17

CUTTING PROCEDURES

Mark out all the cutting lines on the workpiece using suitable media – pencil, crayon, chalk etc. All cutting lines should be clear and readily visible.

- If possible support the workpiece in such a way that it is possible to predict what will happen, and that the cut will remain stable and open while cutting. **(Fig. 16)**
- Align the cutting blade with pre-marked cutting lines. Ensure that the cutting blade is not touching the workpiece before commencing cutting operations.
- Switch the machine 'ON' and allow the blade to reach its full operational speed.
- Gently feed the blade into the workpiece. Performance is best when cutting straight ahead along a pre-marked cutting line. Do not cut a depth greater than 50mm (2"). **(Fig. 17)**
- If a cut of greater than 50 mm (2") is required make several passes.
- Cut smoothly, allowing the machine to do the work without forcing the blade.

WARNING: Do not attempt to cut curved or zig zag lines. Never use the side of the blade as a cutting surface. Never use to perform inclination cutting.

- Move the blade slowly backwards and forwards and try to achieve a small contact area between the blade and the workpiece being cut. This reduces the temperature of the blade and ensures efficient cutting.
- If the blade seizes or there is any abnormal noise, immediately turn the power 'OFF' and investigate the cause. Determine the cause of any noise or stoppage. Only recommence cutting if it is safe to do so.
- Feed the machine down in line with the blade. Sideways pressure on the blade can damage it and can be dangerous.

MAINTENANCE

WARNING: Any maintenance must be carried out with the machine switched off and disconnected from the mains power supply.

On a regular basis check that all safety features and guards are operating correctly. Only use this machine if all guards/safety features are fully operational. All motor bearings in this machine are lubricated for life. No further lubrication is required.

Use a clean, slightly damp cloth to clean the plastic parts of the machine. Do not use solvents or similar products which could damage the plastic or rubber parts.

Removing the blade from the machine will allow access to the inside of the blade guard. Any build up of debris etc can be removed using a blunt non metallic scrapper or similar tool (not supplied).

WARNING: Do not attempt to clean the machine by inserting pointed objects through openings in the machines casings etc. The machines air vents can be cleaned using compressed dry air. Observe all necessary H&S precautions when using compressed air as a cleaning medium.

Excessive sparking may indicate the presence of dirt in the motor or worn out carbon brushes.

If this is suspected have the machine serviced and the brushes replaced by a qualified technician.

ENVIRONMENTAL PROTECTION

Waste electrical products should not be disposed of with household waste. Please recycle where facilities exist. Check with your Local Authority or retailer for recycling advice.



DECLARATION OF CONFORMITY



The manufacturer of the product covered by this Declaration is:

UK: Evolution Power Tools Ltd. Venture One, Longacre Close, Holbrook Industrial Estate, Sheffield, S20 3FR.

FR: Evolution Power Tools SAS. 61 Avenue Lafontaine, 33560, Carbon-Blanc, Bordeaux, France.

The manufacturer hereby declares that the machine as detailed in this declaration fulfils all the relevant provisions of the Machinery Directive and other appropriate directives as detailed below.

The manufacture further declares that the machine as detailed in this declaration, where applicable, fulfils the relevant provisions of the Essential Health and Safety requirements.

The Directives covered by this Declaration are as detailed below:

2006/42/EC.	Machinery Directive.
2014/30/EU.	Electromagnetic Compatibility Directive.
2011/65/EU. & 2015/863/EU.	The Restriction of the Use of certain Hazardous Substances in Electrical Equipment (RoHS) Directive.
2002/96/EC.	as amended by 2003/108/EC The Waste Electrical and Electronic Equipment (WEEE) Directive.

And is in conformity with the applicable requirements of the following documents

EN 60745-1/A11:2010 • EN 60745-2-22: 2011+A11: 2013 • EN 55014-1: 2017 • EN 55014-2: 2015 • EN IEC 61000-3-2:2019 • EN 61000-3-3:2013+A1:2019

Product Details

Description: Evolution 230mm (9") **R230DCT** Electric Disc Cutter
 Evolution 255mm (10") **R255DCT** Electric Disc Cutter
 Evolution 300mm (12") **R300DCT** Electric Disc Cutter
 Evolution 300mm (12") **R300DCT+** Electric Disc Cutter

Brand Name: Evolution Build
 Voltage: 110V ~ 50Hz
 220-240V ~ 50Hz
 Input: 110V: 1600/2000W
 230-240V: 2400W / 2000W

The technical documentation required to demonstrate that the product meets the requirements of directive has been compiled and is available for inspection by the relevant enforcement authorities, and verifies that our technical file contains the documents listed above and that they are the correct standards for the product as detailed above.

Name and address of technical documentation holder.

Signed:  Print: Barry Bloomer
 CEO

Date: 19/05/20

UK: Evolution Power Tools Ltd. Venture One, Longacre Close, Holbrook Industrial Estate, Sheffield, S20 3FR.
FR: Evolution Power Tools SAS. 61 Avenue Lafontaine, 33560, Carbon-Blanc, Bordeaux, France.

evOLUTION®

www.evolutionpowertools.com

US

Evolution Power Tools LLC
8363 Research Drive
Davenport, IA
52806

T: 866-EVO-TOOL

EU

Evolution Power Tools SAS
61 Avenue Lafontaine
33560
Carbon-Blanc
Bordeaux

T: +33 (0)5 57 30 61 89

UK

Evolution Power Tools Ltd
Venture One, Longacre Close
Holbrook Industrial Estate
Sheffield
S20 3FR

T: 0114 251 1022

AUS

Total Tools (Importing) Pty Ltd
20 Thackray Road
Port Melbourne
Vic 3207

T: 03 9261 1900

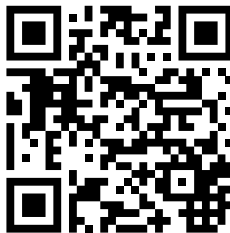

EPT QR CODE