

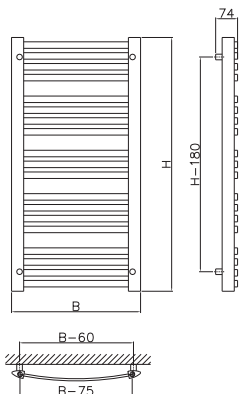



Assembly Instructions

DESIGNER RADIATOR FI/LU/K4

Parts Supplied

Ref	Description	Illustration	Qty
A	Radiator		1
B	Air vent		1
C	Blanking plug		1

Fittings Supplied (for solid walls)

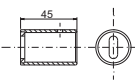
Ref	Description	Illustration	Qty
D	Masonry plug		4
E	Screw		4
F	Bracket		4

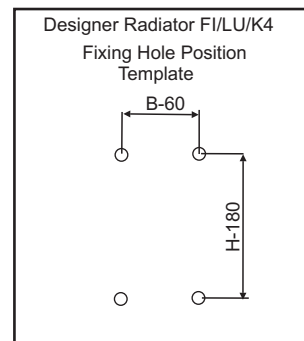

Tools Required (not supplied)

Drilling Machine Drill 8 mm masonry 22 mm Spanner Hammer Flat Nosed Pliers
--

Before you start :

- Please read instructions carefully before installation.
- Check the pack and make sure you have all parts listed above. If not, contact your local store, who will be able to help you.
- Before drilling, first check that there are **no** hidden water pipes or electrical cables.
- This radiator is designed for use on an open or closed heating system up to a max pressure of 3 bars . For use on open systems the warrantee is subject to the addition of an anti-corrosion additive like Fernox.
- When you are ready to start, make sure you have the right tool to hand, plenty of space and clean dry area for assembly.
- Make sure that you use the right type of wall fixing;-masonry wall plugs supplied -.

Installation

1. Using the dimensions given in the fixing hole template if using the plugs supplied drill 4 holes to a depth of approximately 50 mm and a diameter of 8 mm. **NOTE:** The distance from the floor to the bottom of the radiator must be at least 200 mm for efficient heating and ventilation. The distance between the two ½” pipe connections is the width + valve allowance (B).
2. Insert masonry wall plugs (D) provided into the drilled holes, solid walls only.
3. Fasten screw (E) with through bracket (F) to fix securely to the wall.
Take care not to over tighten.
4. Hang the radiator on the brackets.
5. Fit the supplied air vent (B) and blanking plug (C) into the upper threaded openings of the radiator.
6. Connect the water flow and the return pipe to the chosen side of the radiator and the isolation valves (not supplied). Ensure a water tight seal is obtained by using PTFE tape on the threads.
7. How to first fill and vent the radiator:
 - Open the air vent
 - Slightly open the inlet valve (about 10%) while leaving the outlet valve totally closed.
 - Allow the system to fill the radiator. If possible fill without use of the heating pump, it is important that the radiator is filled slowly.
 - When the radiator has been filled close the air vent.
 - Open both inlet and outlet valves totally and use the heating system for about 2 hours.
 - Totally close both inlet and outlet valves.
 - Open the air vent and let out all air.
 - This should clear all air from the radiator. If you are still having problems, on some systems it may be necessary to fit an automatic air vent.
8. Please ensure that a correct seal is made on the connections of the radiator as corrosion due to incorrect installation is not covered under the product warrantee.

Care & Use

- After fitting you **MUST** be absolutely certain that the system is **THOROUGHLY** flushed before it is commissioned in order to rinse out any metal, flux and foreign residues.
- To help prevent internal corrosion and lime scale formation a suitable inhibitor **MUST** be added to the central heating system when it is refilled
- Wipe radiator clean with a soft damp cloth. Never use scourers, abrasives or chemical cleaners.

Troubleshooting

- If some pipels of the radiator are not warm, check and purge once more using step 7.

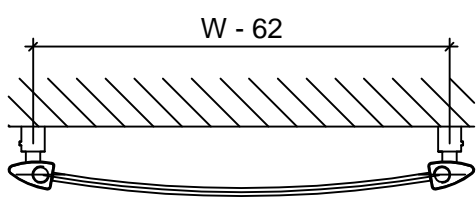
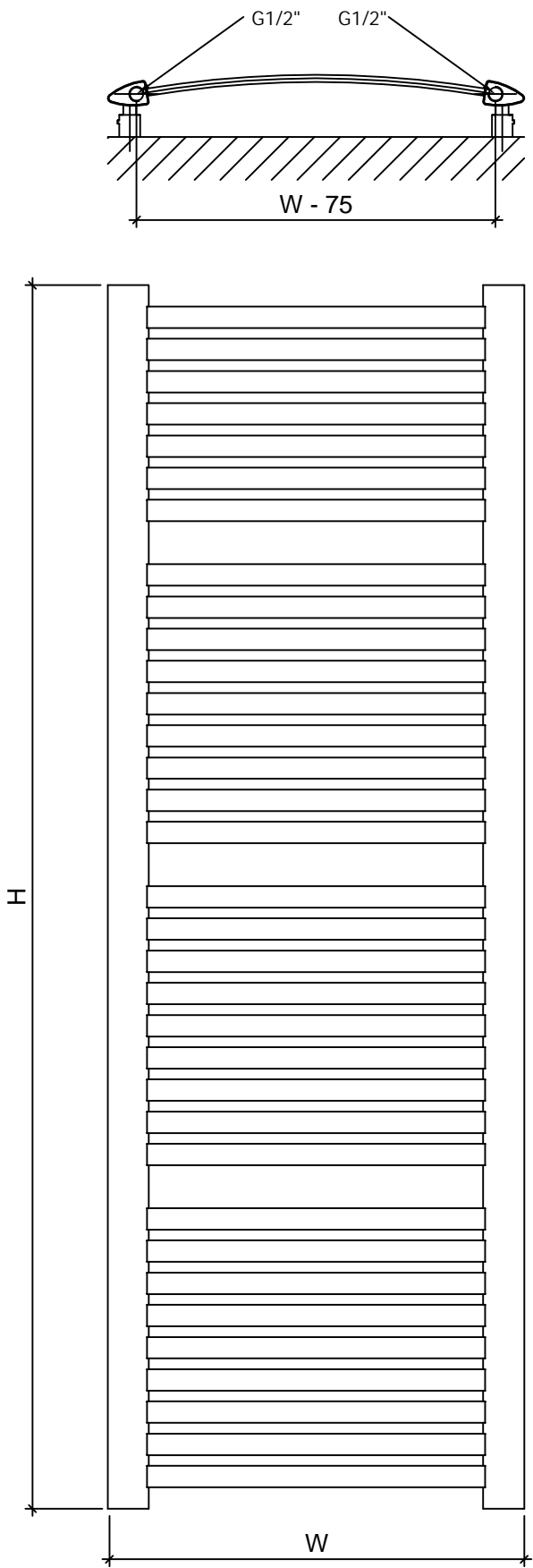

All dimensions in mm! (W = width, H = height)
 Tube layout for height (bottom to up): 765 (5 / 5 / 4); 1215 (6 / 6 / 6 / 5); 1710 (9 / 9 / 9 / 7)
 * Wall to centre ($\frac{1}{2}$ inch)
 ** Wall to front face

