

Robert Bosch GmbH

Power Tools Division
70745 Leinfelden-Echterdingen
Germany

www.bosch-pt.com

2 609 140 989 (2013.02) O / 147 UNI



2 609 140 989

GSR | GSB Professional

18-2-LI



de Originalbetriebsanleitung
en Original instructions
fr Notice originale
es Manual original
pt Manual original
it Istruzioni originali
nl Oorspronkelijke
gebruiksaanwijzing
da Original brugsanvisning
sv Bruksanvisning i original
no Original driftsinstruks
fi Alkuperäiset ohjeet
el Πρωτότυπο οδηγιών χρήσης

tr Orijinal işletme talimatı
pl Instrukcja oryginalna
cs Původní návod k používání
sk Pôvodný návod na použitie
hu Eredeti használati utasítás
ru Оригинальное руководство по
эксплуатации
uk Оригінальна інструкція з
експлуатації
ro Instrucțiuni originale
bg Оригинална инструкция
sr Originalno uputstvo za rad
sl Izvirna navodila

hr Originalne upute za rad
et Algupärane kasutusjuhend
lv Instrukcijas oriģinālvalodā
lt Originali instrukcija
ar تعليمات التشغيل الأصلية
fa دفترچه راهنمای اصلی



8 | English

Akkus/Batterien:**Li-Ion:**

Bitte beachten Sie die Hinweise im Abschnitt „Transport“, Seite 7.

Änderungen vorbehalten.

English

General Power Tool Safety Warnings

⚠ WARNING Read all safety warnings and all instructions. Failure to follow the warnings and instructions may result in electric shock, fire and/or serious injury.

Save all warnings and instructions for future reference.

The term “power tool” in the warnings refers to your mains-operated (corded) power tool or battery-operated (cordless) power tool.

Work area safety

- ▶ **Keep work area clean and well lit.** Cluttered or dark areas invite accidents.
- ▶ **Do not operate power tools in explosive atmospheres, such as in the presence of flammable liquids, gases or dust.** Power tools create sparks which may ignite the dust or fumes.
- ▶ **Keep children and bystanders away while operating a power tool.** Distractions can cause you to lose control.

Electrical safety

- ▶ **Power tool plugs must match the outlet. Never modify the plug in any way. Do not use any adapter plugs with earthed (grounded) power tools.** Unmodified plugs and matching outlets will reduce risk of electric shock.
- ▶ **Avoid body contact with earthed or grounded surfaces, such as pipes, radiators, ranges and refrigerators.** There is an increased risk of electric shock if your body is earthed or grounded.
- ▶ **Do not expose power tools to rain or wet conditions.** Water entering a power tool will increase the risk of electric shock.
- ▶ **Do not abuse the cord. Never use the cord for carrying, pulling or unplugging the power tool. Keep cord away from heat, oil, sharp edges and moving parts.** Damaged or entangled cords increase the risk of electric shock.
- ▶ **When operating a power tool outdoors, use an extension cord suitable for outdoor use.** Use of a cord suitable for outdoor use reduces the risk of electric shock.
- ▶ **If operating a power tool in a damp location is unavoidable, use a residual current device (RCD) protected supply.** Use of an RCD reduces the risk of electric shock.

Personal safety

- ▶ **Stay alert, watch what you are doing and use common sense when operating a power tool. Do not use a power tool while you are tired or under the influence of drugs, alcohol or medication.** A moment of inattention while operating power tools may result in serious personal injury.
- ▶ **Use personal protective equipment. Always wear eye protection.** Protective equipment such as dust mask, non-skid safety shoes, hard hat, or hearing protection used for appropriate conditions will reduce personal injuries.
- ▶ **Prevent unintentional starting. Ensure the switch is in the off-position before connecting to power source and/or battery pack, picking up or carrying the tool.** Carrying power tools with your finger on the switch or engaging power tools that have the switch on invites accidents.
- ▶ **Remove any adjusting key or wrench before turning the power tool on.** A wrench or a key left attached to a rotating part of the power tool may result in personal injury.
- ▶ **Do not overreach. Keep proper footing and balance at all times.** This enables better control of the power tool in unexpected situations.
- ▶ **Dress properly. Do not wear loose clothing or jewellery. Keep your hair, clothing and gloves away from moving parts.** Loose clothes, jewellery or long hair can be caught in moving parts.
- ▶ **If devices are provided for the connection of dust extraction and collection facilities, ensure these are connected and properly used.** Use of dust collection can reduce dust-related hazards.

Power tool use and care

- ▶ **Do not force the power tool. Use the correct power tool for your application.** The correct power tool will do the job better and safer at the rate for which it was designed.
- ▶ **Do not use the power tool if the switch does not turn it on and off.** Any power tool that cannot be controlled with the switch is dangerous and must be repaired.
- ▶ **Disconnect the plug from the power source and/or the battery pack from the power tool before making any adjustments, changing accessories, or storing power tools.** Such preventive safety measures reduce the risk of starting the power tool accidentally.
- ▶ **Store idle power tools out of the reach of children and do not allow persons unfamiliar with the power tool or these instructions to operate the power tool.** Power tools are dangerous in the hands of untrained users.
- ▶ **Maintain power tools. Check for misalignment or binding of moving parts, breakage of parts and any other condition that may affect the power tool's operation. If damaged, have the power tool repaired before use.** Many accidents are caused by poorly maintained power tools.
- ▶ **Keep cutting tools sharp and clean.** Properly maintained cutting tools with sharp cutting edges are less likely to bind and are easier to control.

- ▶ **Use the power tool, accessories and tool bits etc. in accordance with these instructions, taking into account the working conditions and the work to be performed.** Use of the power tool for operations different from those intended could result in a hazardous situation.

Battery tool use and care

- ▶ **Recharge only with the charger specified by the manufacturer.** A charger that is suitable for one type of battery pack may create a risk of fire when used with another battery pack.
- ▶ **Use power tools only with specifically designated battery packs.** Use of any other battery packs may create a risk of injury and fire.
- ▶ **When battery pack is not in use, keep it away from other metal objects, like paper clips, coins, keys, nails, screws or other small metal objects, that can make a connection from one terminal to another.** Shorting the battery terminals together may cause burns or a fire.
- ▶ **Under abusive conditions, liquid may be ejected from the battery; avoid contact. If contact accidentally occurs, flush with water. If liquid contacts eyes, additionally seek medical help.** Liquid ejected from the battery may cause irritation or burns.

Service

- ▶ **Have your power tool serviced by a qualified repair person using only identical replacement parts.** This will ensure that the safety of the power tool is maintained.

Safety Warnings for Drills and Screwdriver

GSB 18-2-LI

- ▶ **Wear ear protectors when impact drilling.** Exposure to noise can cause hearing loss.

GSR 18-2-LI/GSB 18-2-LI

- ▶ **Hold power tool by insulated gripping surfaces, when performing an operation where the cutting accessory or fastener may contact hidden wiring.** Cutting accessory and fasteners contacting a "live" wire may make exposed metal parts of the power tool "live" and could give the operator an electric shock.
- ▶ **Use auxiliary handle(s), if supplied with the tool.** Loss of control can cause personal injury.
- ▶ **Use appropriate detectors to determine if utility lines are hidden in the work area or call the local utility company for assistance.** Contact with electric lines can lead to fire and electric shock. Damaging a gas line can lead to explosion. Penetrating a water line causes property damage.
- ▶ **Switch off the power tool immediately when the tool insert jams. Be prepared for high reaction torque that can cause kickback.** The tool insert jams when:
 - the power tool is subject to overload or
 - it becomes wedged in the workpiece.

- ▶ **Hold the machine with a firm grip.** High reaction torque can briefly occur while driving in and loosening screws.
- ▶ **Secure the workpiece.** A workpiece clamped with clamping devices or in a vice is held more secure than by hand.
- ▶ **Do not open the battery.** Danger of short-circuiting.



Protect the battery against heat, e. g., against continuous intense sunlight, fire, water, and moisture. Danger of explosion.



- ▶ **In case of damage and improper use of the battery, vapours may be emitted. Ventilate the area and seek medical help in case of complaints.** The vapours can irritate the respiratory system.
- ▶ **Use the battery only in conjunction with your Bosch power tool.** This measure alone protects the battery against dangerous overload.
- ▶ **Use only original Bosch batteries with the voltage listed on the nameplate of your power tool.** When using other batteries, e. g. imitations, reconditioned batteries or other brands, there is danger of injury as well as property damage through exploding batteries.

Additional Safety and Working Instructions









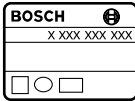

- ▶ **Dusts from materials such as lead-containing coatings, some wood types, minerals and metal can be harmful to one's health and cause allergic reactions, lead to respiratory infections and/or cancer.** Materials containing asbestos may only be worked by specialists.
 - Provide for good ventilation of the working place.
 - It is recommended to wear a P2 filter-class respirator.
 Observe the relevant regulations in your country for the materials to be worked.
- ▶ **Prevent dust accumulation at the workplace.** Dusts can easily ignite.
- ▶ **Before any work on the machine (e. g., maintenance, tool change, etc.) as well as during transport and storage, set the rotational direction switch to the centre position.** Unintentional actuation of the On/Off switch can lead to injuries.
- ▶ **The battery is supplied partially charged. To ensure full battery capacity, completely charge the battery in the battery charger before using for the first time.**
- ▶ **The battery is equipped with a NTC temperature control which allows charging only within a temperature range of between 0 °C and 45 °C. A long battery service life is achieved in this manner.**
- ▶ **Read the operating instructions of the battery charger.**
- ▶ **Apply the power tool to the screw only when it is switched off.** Rotating tool inserts can slip off.
- ▶ **Adjust the gear switch only when the machine is at a complete stop.**









10 | English

- ▶ **Always push the gear selector and turn the operating mode selector switch through to the stop.** Otherwise, the machine can become damaged.
- ▶ To save energy, only switch the power tool on when using it.

Symbols

The following symbols are important for reading and understanding the operating instructions. Please take note of the symbols and their meaning. The correct interpretation of the symbols will help you to use the machine in a better and safer manner.

| Symbol | Meaning |
|---|--|
|  | GSR 18-2-LI/GSB 18-2-LI: Cordless screwdriver/Combination cordless drill Grey-marked area: Handle (insulated gripping surface) |
|  | Article number |
|  | Read all safety warnings and all instructions |
|  | Before any work on the machine itself, remove the battery |
|  | Always wear ear protection. |
|  | Movement direction |
|  | Reaction direction |
|  | Screwdriving |
|  | Drilling without impact |
|  | Impact drilling |
|  | Low speed |
|  | High speed |

| Symbol | Meaning |
|--|--|
|  | Switching On |
|  | Switching Off |
|  | Right/left rotation |
| U | Rated voltage |
| n_s | Impact rate |
| $n_0 1$ | No-load speed (1. gear) |
| $n_0 2$ | No-load speed (2. gear) |
| M | Maximum torque according to ISO 5393 |
|  | Brickwork |
|  | Metal |
|  | Wood |
| \emptyset | Drilling diameter, max. |
|  | Max. screw dia. |
|  | Chuck clamping range |
|  | Weight according to EPTA-Procedure 01/2003 |
| * | Value dependent of the battery pack being used |
| L_{WA} | Sound power level |
| L_{pA} | Sound pressure level |
| K | Uncertainty |
| a_h | Vibration total value |

Delivery Scope

Cordless screwdriver/Combination cordless drill.
Battery, application tools and other accessories shown or described are not part of the standard delivery scope.
A complete overview of accessories can be found in our accessories program.

Intended Use

The machine is intended for driving in and loosening screws as well as for drilling in wood, metal, ceramics and plastic. GSB machines are additionally intended for impact drilling in bricks, brickwork and masonry.

Technical Data

The technical data of the machine are listed in the table on page 141.

Please observe the article number on the type plate of your machine. The trade names of the individual machines may vary.

Declaration of Conformity

We declare under our sole responsibility that the product described under "Technical Data" is in conformity with the following standards or standardization documents: EN 60745 according to the provisions of the directives 2011/65/EU, 2004/108/EC, 2006/42/EC.

Technical file (2006/42/EC) at:
Robert Bosch GmbH, PT/ETM9,
D-70745 Leinfelden-Echterdingen

Dr. Egbert Schneider Helmut Heinzemann
Senior Vice President Head of Product Certification
Engineering PT/ETM9

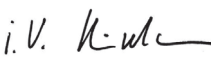
 i. V. 

Robert Bosch GmbH, Power Tools Division
D-70745 Leinfelden-Echterdingen
30.01.2013

Noise/Vibration Information

The measured values of the machine are listed in the table on page 141.

Noise and vibrational values (vector sum of three directions) determined according to EN 60745.

The vibration emission level given in this information sheet has been measured in accordance with a standardised test given in EN 60745 and may be used to compare one tool with another. It may be used for a preliminary assessment of exposure.

The declared vibration emission level represents the main applications of the tool. However if the tool is used for different applications, with different accessories or poorly maintained, the vibration emission may differ. This may significantly increase the exposure level over the total working period.

An estimation of the level of exposure to vibration should also take into account the times when the tool is switched off or when it is running but not actually doing the job. This may significantly reduce the exposure level over the total working period.

Identify additional safety measures to protect the operator from the effects of vibration such as: maintain the tool and the accessories, keep hands warm, organise work patterns.

Mounting and Operation

| Action | Figure | Page |
|------------------------------------|--------|------|
| Removing the battery | 1 | 142 |
| Inserting the battery | 2 | 142 |
| Mounting application tools | 3 | 142 |
| Reversing the rotational direction | 4 | 143 |
| Setting the torque | 5 | 143 |
| Setting the operating mode | 6 | 144 |
| Gear selection, mechanical | 7 | 144 |
| Switching On and Off | 8 | 145 |
| Selecting Accessories | - | 146 |

Maintenance and Cleaning

- **For safe and proper working, always keep the machine and ventilation slots clean.**

Clean the application tool, the tool holder, the power tool's ventilation slots, and the battery's ventilation slots each time after using.

After-sales Service and Application Service

Our after-sales service responds to your questions concerning maintenance and repair of your product as well as spare parts. Exploded views and information on spare parts can also be found under:

www.bosch-pt.com

Bosch's application service team will gladly answer questions concerning our products and their accessories.

In all correspondence and spare parts order, please always include the 10-digit article number given on the type plate of the machine.

Great Britain

Robert Bosch Ltd. (B.S.C.)
P.O. Box 98
Broadwater Park
North Orbital Road
Denham
Uxbridge
UB 9 5HJ
Tel. Service: (0844) 7360109
Fax: (0844) 7360146
E-Mail: boschservicecentre@bosch.com

12 | English

Ireland

Origo Ltd.
Unit 23 Magna Drive
Magna Business Park
City West
Dublin 24
Tel. Service: (01) 4666700
Fax: (01) 4666888

Australia, New Zealand and Pacific Islands

Robert Bosch Australia Pty. Ltd.
Power Tools
Locked Bag 66
Clayton South VIC 3169
Customer Contact Center
Inside Australia:
Phone: (01300) 307044
Fax: (01300) 307045
Inside New Zealand:
Phone: (0800) 543353
Fax: (0800) 428570
Outside AU and NZ:
Phone: +61 3 95415555
www.bosch.com.au

Republic of South Africa

Customer service
Hotline: (011) 6519600

Gauteng – BSC Service Centre

35 Roper Street, New Centre
Johannesburg
Tel.: (011) 4939375
Fax: (011) 4930126
E-Mail: bsctools@icon.co.za

KZN – BSC Service Centre

Unit E, Almar Centre
143 Crompton Street
Pinetown
Tel.: (031) 7012120
Fax: (031) 7012446
E-Mail: bsc.dur@za.bosch.com

Western Cape – BSC Service Centre

Democracy Way, Prosperity Park
Milnerton
Tel.: (021) 5512577
Fax: (021) 5513223
E-Mail: bsc@zsd.co.za

Bosch Headquarters

Midrand, Gauteng
Tel.: (011) 6519600
Fax: (011) 6519880
E-Mail: rbsa-hq.pts@za.bosch.com

Transport

The contained lithium ion batteries are subject to the Dangerous Goods Legislation requirements. The user can transport the batteries by road without further requirements.

When being transported by third parties (e.g.: air transport or forwarding agency), special requirements on packaging and labelling must be observed. For preparation of the item being shipped, consulting an expert for hazardous material is required.

Dispatch batteries only when the housing is undamaged.

Tape or mask off open contacts and pack up the battery in such a manner that it cannot move around in the packaging. Please also observe possibly more detailed national regulations.

Disposal

The machine, rechargeable batteries, accessories and packaging should be sorted for environmental-friendly recycling.

Do not dispose of power tools and batteries/rechargeable batteries into household waste!

Only for EC countries:

According to the European Guideline 2012/19/EU, power tools that are no longer usable, and according to the European Guideline 2006/66/EC, defective or used battery packs/batteries, must be collected separately and disposed of in an environmentally correct manner.

Batteries no longer suitable for use can be directly returned at:

Great Britain

Robert Bosch Ltd. (B.S.C.)
P.O. Box 98
Broadwater Park
North Orbital Road
Denham
Uxbridge
UB 9 5HJ
Tel. Service: (0844) 7360109
Fax: (0844) 7360146
E-Mail: boschservicecentre@bosch.com











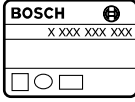



Battery packs/batteries:**Li-ion:**

Please observe the instructions in section "Transport", page 12.

Subject to change without notice.

GSR 18-2-LI

GSB 18-2-LI

|  | | 3 601 JB7 3.. | 3 601 JD2 3.. |
|---|-------------------|---------------|---------------|
| U | V= | 18 | 18 |
| $n_0 1$ | min^{-1} | 0 – 450 | 0 – 450 |
| $n_0 2$ | min^{-1} | 0 – 1400 | 0 – 1400 |
| n_s | min^{-1} | – | 0 – 19 500 |
| M  | Nm | 38 | 39 |
| M  | Nm | 17* | 18* |
| \emptyset  | mm | – | 10 |
| \emptyset  | mm | 10 | 10 |
| \emptyset  | mm | 30 | 30 |
| \emptyset  | mm | 7 | 7 |
|  | mm | 1,0 – 10 | 1,0 – 10 |
|  | kg | 1,3* | 1,4* |
| L_{WA} | dB(A) | 79 | 93 |
| L_{pA} | dB(A) | 68 | 92 |
| K | dB | 3 | 3 |
| a_h   | m/s^2 | – | 13 |
| a_h   | m/s^2 | <2,5 | <2,5 |
| a_h  | m/s^2 | <2,5 | <2,5 |
| K | m/s^2 | 1,5 | 1,5 |

142 |

1

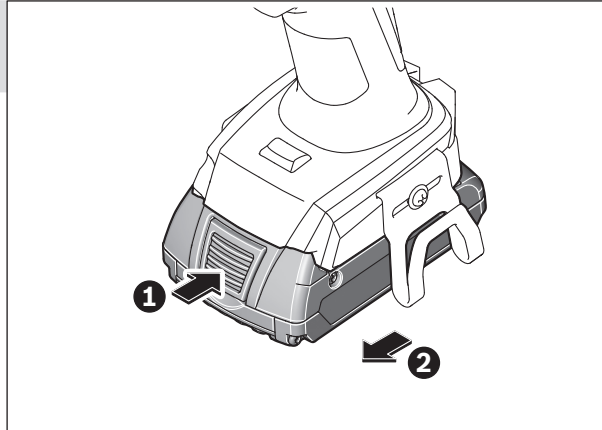
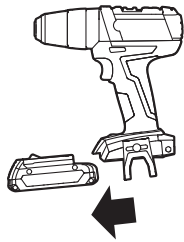

2

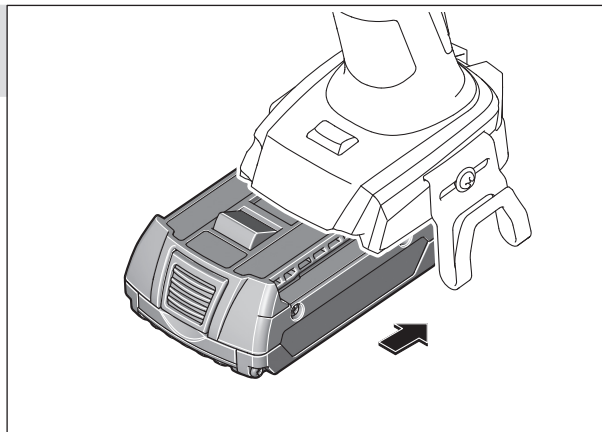
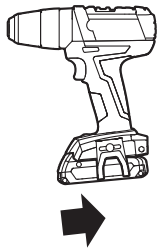

3

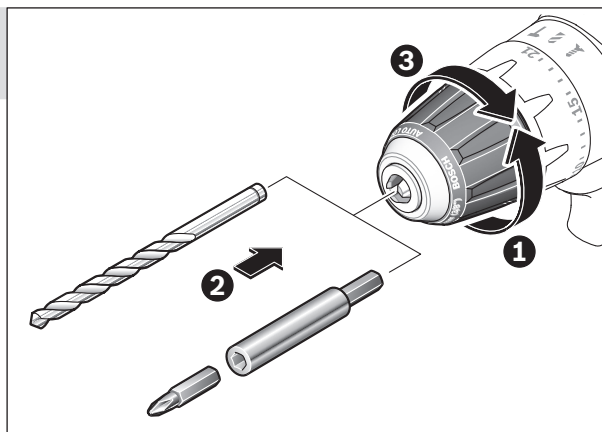
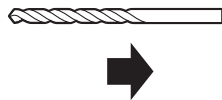

4

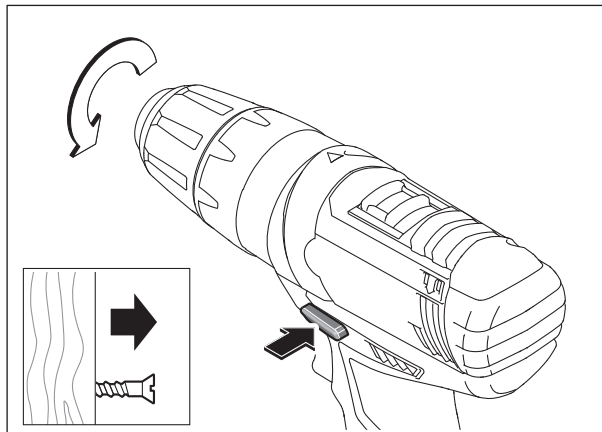
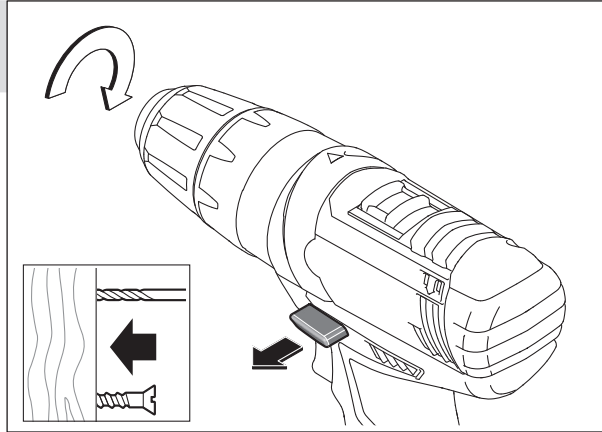
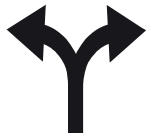

5

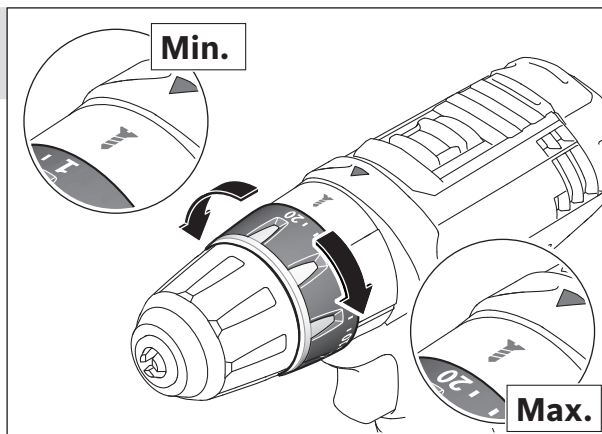



6

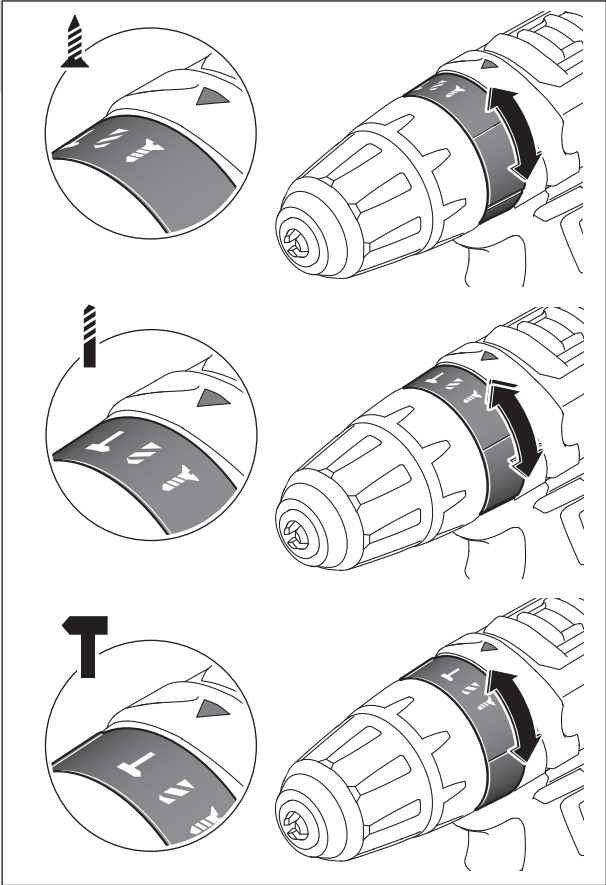

7

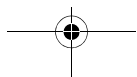
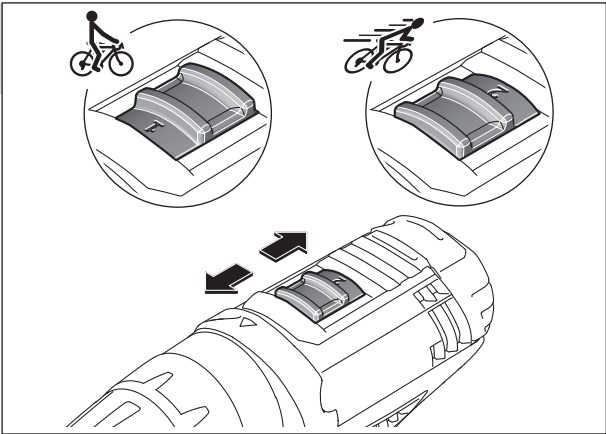
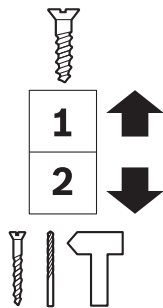



8

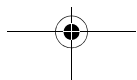
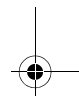
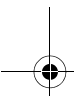
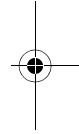
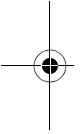
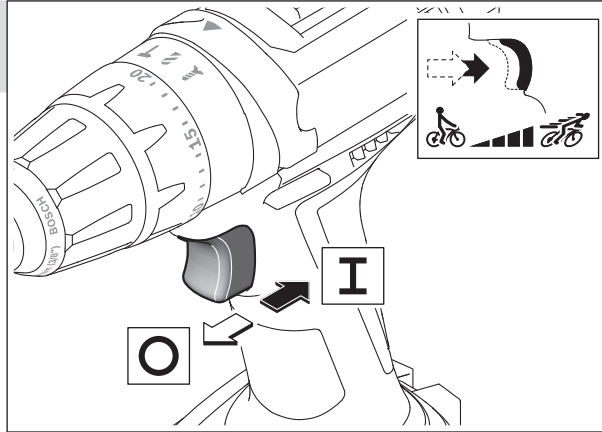

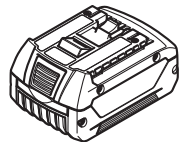

18 V (Li-Ion)

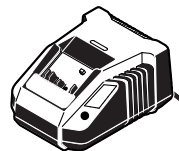
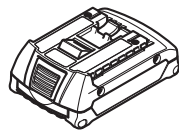

**AL 1820 CV
(14,4 / 18 V)**

2 607 225 424 (EU)
2 607 225 426 (UK)

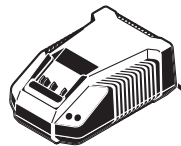

**AL 1860 CV
(14,4 / 18 V)**

2 607 225 322 (EU)
2 607 225 324 (UK)

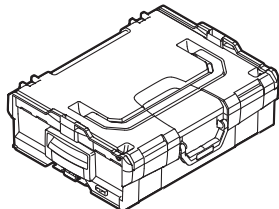

2 608 438 692
(L-BOXX 136)

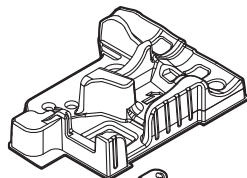

2 608 438 092

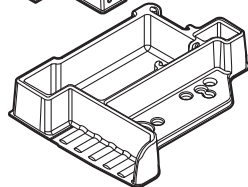

2 608 438 102

