

GB

Titan Power Tools (UK) Ltd  
Trade House, Mead Avenue,  
BA22 8RT

**TITAN**

# 15mm Nailer/Stapler

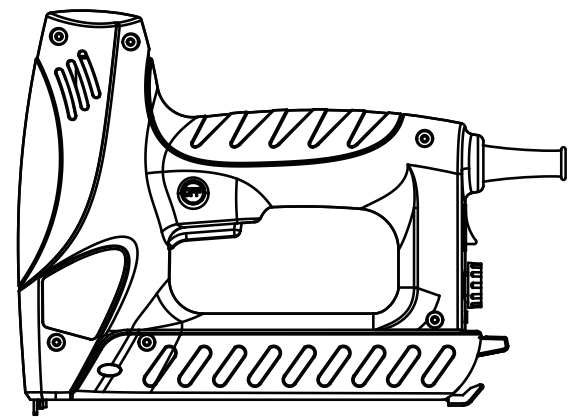

**TTB515STP**

Barcode: 5052931216246



Original Instructions\_MNL\_TTB515STP\_GB\_V08\_130523

**WARNING! Read the instructions before using the product!**



# TITAN

**Congratulations on your purchase of a TITAN power tool from TITAN Power Tools (UK) Ltd. We want you to continue getting the best performance from it so this handbook includes information on safety, handling and care. Please retain this handbook in case you need to refer to any of the information in the future. Your TITAN power tool comes with a 2 year guarantee, so should it develop a fault within this period contact your retailer.**



## **GUARANTEE**

This TITAN product carries a 2 year guarantee. If your product develops a fault within this period, you should, in the first instance contact the retailer where the item was purchased.

This guarantee specifically excludes losses caused due to:

- Fair wear and tear
- Misuse or abuse
- Lack of routine maintenance
- Failure of consumable items (such as batteries)
- Accidental damage
- Cosmetic damage
- Failure to follow manufacturer's guidelines
- Loss of use of the goods

This guarantee does not affect your statutory rights. This guarantee is only valid in the UK.

**15MM NAILER/STAPLER      TTB515STP**

# Let's get started...

These instructions are for your safety. Please read through them thoroughly before use and retain them for future reference.



## Getting started...

03

**Your product**  
**Technical and legal information**  
**Before you start**

04

05

10



## In more detail...

12

**Product functions**  
**Care and maintenance**  
**Trouble shooting**  
**Recycling and disposal**  
**EC declaration of conformity**

13

15

18

19

20

# TITAN

## Declaration of Conformity

We, Importer  
**Titan Power Tools (UK) Ltd**  
Trade House, Mead Avenue, BA22 8RT

Declare that the product:  
**Designation: 15mm nailer/stapler**  
**Model:TTB515STP**

Complies with the following Directives:  
**2004/108/EC** Electromagnetic Compatibility Directive  
**2006/42/EC** Machinery Directive  
**2006/95/EC** Low Voltage Directive

**2011/65/EU** Restrictions of the Use of Certain Hazardous Substances in Electrical and Electronic Equipment  
**2012/19/EU** Waste Electrical and Electronic Equipment (WEEE)

Standards and technical specifications referred to:

**EN60745-1:2009+A11:2010**  
**EN60745-2-16:2010**  
**EN55014-1:2006/+A1:2009/+A2:2011**  
**EN55014-2:1997/+A1:2001/+A2:2008**  
**EN61000-3-2:2006/+A1:2009/+A2:2009**  
**EN61000-3-3:2013**

Authorised Signatory and technical file holder

Date : 01/04/2014

Signature: P.C. Harries

Name / title: Peter Harries / Quality Manager

Titan Power Tools (UK) Ltd. Trade House, Mead Avenue, BA22 8RT





## Recycling and disposal



> Waste electrical products should not be disposed of with household waste. Please recycle where facilities exist. Check with your Local Authority or local store for recycling advice.

## Your product

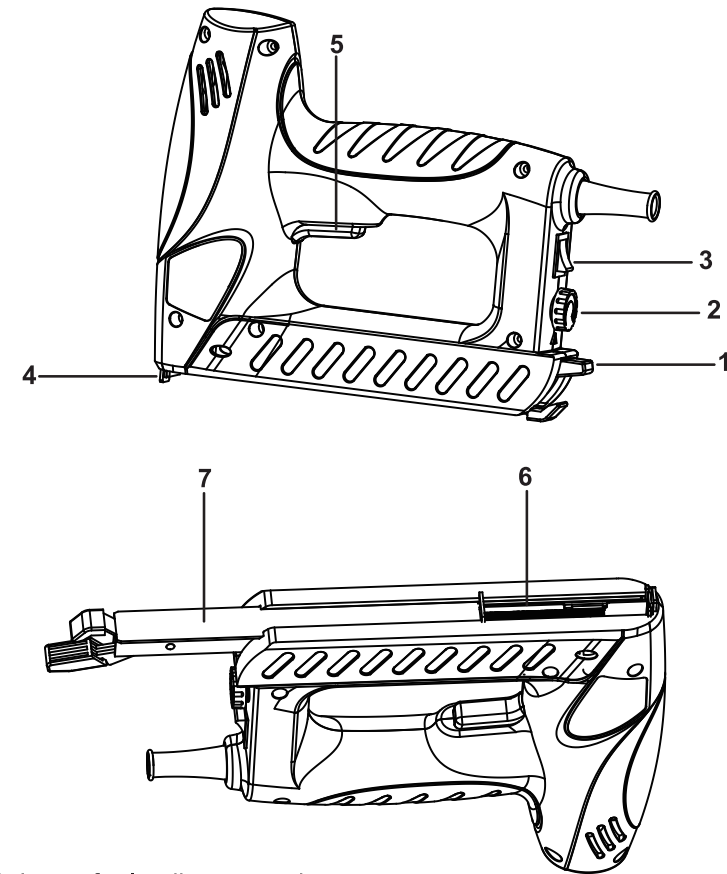

1. Lever for loading magazine
2. Impact control selection wheel
3. On/off switch
4. Nailer/Stapler head
5. Trigger
6. Magazine
7. State nail guage

## Technical specifications

### General

- > **Input Voltage** : 230 - 240V, 50 Hz, 5A
- > **Max.Firing speed** : 20-Nails/Staples- per minute
- > **Max.Length of nail** : Up to 15mm long
- > **Max.Length of staple** : Up to 14mm long
- > **Max.Magazine Capacity** : Holds up to 80 nails or 100 staples
- > **Nail/Staple Type (IMPORTANT)** : Use Staples: TACWISE Types 53  
Nails: TACWISE 18ga  
Straight Nails. Max Length 15mm

### VIBRATION

The European Physical Agents (Vibration) Directive has been brought in to help reduce hand arm vibration syndrome injuries to power tool users. The directive requires power tool manufacturers and suppliers to provide indicative vibration test results to enable users to make informed decisions as to the period of time a power tool can be used safely on a daily basis and the choice of tool.

Further Advice can be found at [www.hse.gov.uk](http://www.hse.gov.uk)

<b>Sound level according to EN 60745-1</b>	Sound pressure level $L_{pA}$ : 77dB(A)
	Sound power level $L_{WA}$ : 88dB(A)
	Uncertainty $K_{pA}$ , $K_{WA}$ : 3dB(A)
<b>Hand arm vibration according to EN 60745-1</b>	Surface grinding $a_{h,AG}$ : 4.83 m/s <sup>2</sup>
	Uncertainty K : +/-1.5 m/s <sup>2</sup>

The declared vibration emission value should be used as a minimum level and should be used with the current guidance on vibration.

Calculating the actual period of the actual period off use can be difficult and the HSE website has further information.

The declared vibration emission been measured in accordance with a standardised test stated above and may be used to compare one tool with another. The declared vibration emission value may also be used in a preliminary assessment of exposure.



**Warning!** The vibration emission value during actual use of the power tool can differ from the declared value depending on the ways in which the tool is used dependant on the following examples and other variations on how the tool is used: How the tool is used and the materials being ground or cut.

The tool being in good condition and well maintained.

The use the correct accessory for the tool and ensuring it is sharp and in good condition.

The tightness of the grip on the handles.

And the tool is being used as intended by its design and these instructions.

## Trouble shooting

Suspected malfunctions are often due to causes that the users can fix themselves. Therefore check the product using this section. In most cases the problem can be solved quickly.



**WARNING!** Only perform the steps described within these instructions! All further inspection, maintenance and repair work must be performed by an authorised service centre or a similarly qualified specialist if you cannot solve the problem yourself!

Problem	Possible cause	Solution
1. Product does not start	1.1 Not connected to power supply 1.2 Product not switch on 1.3 Power cord or plug is defective 1.4 Other electrical defect to the product	1.1. Connect to power supply 1.2 Switch ON 1.3. Check by a specialist electrician. 1.4. Check by a specialist electrician
2. Product does not reach full power	2.1 Extension cord not suitable for operation with this product 2.2 Power source (e.g. generator) has too low voltage 2.3 Air vents are blocked	2.1. Use a proper extension cord 2.2. Connect to another power source 2.3. Clean the air vents
3. Fasteners jam in tool	3.1 Wrong size fasteners 3.2 Driver channel worn 3.3 Bent fasteners 3.4 Loose magazine/nose screws 3.5 Broken/chipped driver	3.1. Use only recommended fasteners 3.2. Replace nailer/stapler 3.3. Discontinue using these fasteners 3.4. Tighten all screws 3.5. Replace nailer/stapler

## Repair

---

- > This product does not contain any parts that can be repaired by the consumer. Contact a qualified specialist to have it checked and repaired.

## Storage

---

- > Clean the product as described above.
- > Store the product and its accessories in a dry, frost-free place.
- > Always store the product in a place that is inaccessible to children. The ideal storage temperature is between 10 and 30°C.
- > We recommend using the original package for storage or covering the product with a suitable cloth to protect it against dust.

## Transportation

---

- > Switch the product off and disconnect it from power supply before transporting it anywhere.
- > Attach transportation guards, if applicable.
- > Always carry the product by its handles.
- > Protect the product from any heavy impact or strong vibrations which may occur during transportation in vehicles.
- > Secure the product to prevent it from slipping or falling over.

### This tool may cause hand-arm vibration syndrome if its use is not adequately managed

 **Warning!** identify safety measures to protect the operator that are based on an estimation of exposure in the actual conditions of use (taking account of all parts of the operating cycle such as the times when the tool is switched off and when it is running idle in addition to the trigger time). Note The use of other tools will reduce the users' total working period on this tool.

Helping to minimise your vibration exposure risk.

Maintain this tool in accordance with these instructions and keep well lubricated (where appropriate)

Avoid using tools in temperatures of 10°C or less

Plan your work schedule to spread any high vibration tool use across a number of days.

Health Surveillance

All employees should be part of an employer's health surveillance scheme to help identify any vibration related diseases at an early stage, prevent disease progression and help employees stay in work.

### Double insulation:

The tool is double insulated. This means that all the external metal parts are electrically insulated from the mains power supply. This is done by placing insulation barriers between the electrical and mechanical components making it unnecessary for the tool to be earthed.

### Important note:

Be sure the supply is the same as the voltage given on the rating plate.

The tool is fitted with a two-core cable and plug.

Remove the mains plug from socket before carrying out any adjustment or servicing.

## Symbols

---

On the product, the rating label and within these instructions you will find among others the following symbols and abbreviations.

Familiarise yourself with them to reduce hazards like personal injuries and damage to property.

V~	Volt, (alternating voltage)	Hz	Hertz
A	Ampere	kg	Kilogram
m/s <sup>2</sup>	Metres per seconds squared	dB(A)	Decibel (A-rated)

yyWxx Manufacturing date code; year of manufacturing (20yy) and week of manufacturing (Wxx);



Caution / Warning.



Wear hearing protection.



Read the instruction manual.



Wear eye protection.



Wear respiratory protection.



This product is of protection class II. That means it is equipped with enhanced or double insulation.



The product complies with the applicable European directives and an evaluation method of conformity for these directives was done.



WEEE symbol. Waste electrical products should not be disposed of with household waste. Please recycle where facilities exist. Check with your Local Authority or local store for recycling advice.

## Safety warnings

### GENERAL SAFETY INSTRUCTIONS



**WARNING!** Read all instructions. Failure to follow all instructions listed below may result in electric shock, fire and/or serious injury. The term "power tool" in all of the warnings listed below refers to your mains operated (corded) power tool or battery operated (cordless) power tool.

#### 1) WORK AREA

- > **Keep work area clean and well lit.** Cluttered and dark areas invite accidents.
- > **Do not operate power tools in explosive atmospheres, such as in the presence of flammable liquids, gases or dust.** Power tools create sparks which may ignite the dust or fumes.
- > **Keep children and bystanders away while operating a power tool.** Distractions can cause you to lose control.

## Power cord

- > If the power cord is damaged, it must be replaced by the manufacturer, its service agent or similarly qualified persons in order to avoid a safety hazard.

## UK plug

If you need to replace the fitted plug, then follow the instructions below.

**IMPORTANT:** The wires in the mains lead are coloured in accordance with the following code:

Blue – Neutral                      Brown – Live

As the colours of the wire in the mains lead of this product may not correspond with the coloured marking identifying the terminals in your plug, proceed as follows. The wire, which is coloured blue, must be connected to the terminal, which is marked with N or coloured black. The wire, which is coloured brown, must be connected to the terminal, which is marked L or coloured red.

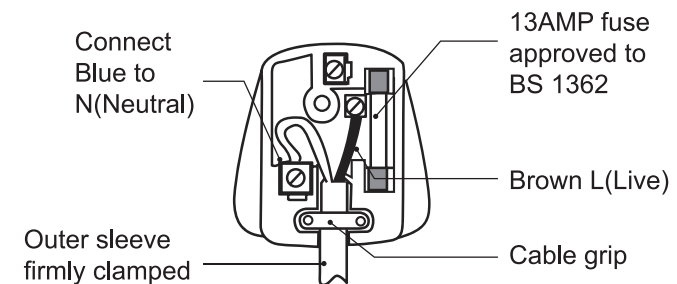

**WARNING!** Never connect live or neutral wires to the earth terminal of the plug.

Only fit an approved 13 Amp BS 1363 or BS 1363/A plug and the correctly rated fuse.

If in doubt, consult a qualified electrician.



**NOTE:** If a moulded plug is fitted and has to be removed take great care in disposing of the plug and severed cable, it must be destroyed to prevent engaging into a socket.

## 4 Golden rules for servicing

- > Switch off and remove plug.
- > Clean the ventilation grill and on / off button with a soft brush.
- > Make sure that the ventilation openings are always clear and clean.
- > Use a damp cloth with water to clean your stapler, but do not use alcohol, caustic cleaner.

## General operation

- > Check the product, its power cord and plug as well as accessories for damage before each use. Do not use the product if it is damaged or shows wear.
- > Always hold the product correctly. Keep the handle dry to ensure safe support.
- > Ensure that the air vents are always unobstructed and clear.
- > Clean them if necessary with a soft brush. Blocked air vents may lead to overheating and damage the product.
- > Switch the product off immediately if you are disturbed while working by other people entering the working area.
- > Do not overwork yourself. Take regular breaks to ensure you can concentrate on the work and have full control over the product.

## After use

- > Switch the product off, disconnect it from the power supply and let it cool down on a minimum of 20 minutes before storing.
- > Store the product and its accessories in a dry, frost-free place.
- > Always store the product in a place that is inaccessible to children.

## 2) ELECTRICAL SAFETY

- > **Power tool plugs must match the outlet. Never modify the plug in any way. Do not use any adapter plugs with earthed (grounded) power tools.** Unmodified plugs and matching outlets will reduce risk of electric shock.
- > **Avoid body contact with earthed or grounded surfaces such as pipes, radiators, ranges and refrigerators.** There is an increased risk of electric shock if your body is earthed or grounded.
- > **Do not expose power tools to rain or wet conditions.** Water entering a power tool will increase the risk of electric shock.
- > **Do not abuse the cord. Never use the cord for carrying, pulling or unplugging the power tool. Keep cord away from heat, oil, sharp edges or moving parts.** Damaged or entangled cords increase the risk of electric shock.

## 3) PERSONAL SAFETY

- > **Stay alert, watch what you are doing and use common sense when operating a power tool. Do not use a power tool while you are tired or under the influence of drugs, alcohol or medication.** A moment of inattention while operating power tools may result in serious personal injury.
- > **Use safety equipment. Always wear eye protection.** Safety equipment such as dust mask, non-skid safety shoes, hard hat, or hearing protection used for appropriate conditions will reduce personal injuries.
- > **Remove any adjusting key or wrench before turning the power tool on.** A wrench or a key left attached to a rotating part of the power tool may result in personal injury.
- > **Do not overreach. Keep proper footing and balance at all times.** This enables better control of the power tool in unexpected situations.
- > **Dress properly. Do not wear loose clothing or jewellery. Keep your hair, clothing and gloves away from moving parts.** Loose clothes, jewellery or long hair can be caught in moving parts.
- > **If devices are provided for the connection of dust extraction and collection facilities, ensure these are connected and properly used.** Use of these devices can reduce dust related hazards.

## 4) POWER TOOL USE AND CARE

- > **Do not force the power tool. Use the correct power tool for your application.** The correct power tool will do the job better and safer at the rate for which it was designed.
- > **Do not use the power tool if the switch does not turn it on and off.** Any power tool that cannot be controlled with the switch is dangerous and must be repaired.
- > **Ensure the switch is in the off position before making any adjustments, changing accessories, or storing power tools.** Such preventive safety measures reduce the risk of starting the power tool accidentally.



- > **Store idle power tools out of the reach of children and do not allow persons unfamiliar with the power tool or these instructions to operate the power tool.** Power tools are dangerous in the hands of untrained users.
- > **Maintain power tools. Check for misalignment or binding of moving parts, breakage of parts and any other condition that may affect the power tools operation. If damaged, have the power tool repaired before use.** Many accidents are caused by poorly maintained power tools.
- > **Keep cutting tools sharp and clean.** Properly maintained cutting tools with sharp cutting edges are less likely to bind and are easier to control.
- > **Use the power tool, accessories and tool bits etc., in accordance with these instructions and in the manner intended for the particular type of power tool, taking into account the working conditions and the work to be performed.** Use of the power tool for operations different from those intended could result in a hazardous situation.

#### 5) SERVICE

- > **Have your power tool serviced by a qualified repair person using only identical replacement parts.** This will ensure that the safety of the power tool is maintained.

#### SAFETY INSTRUCTIONS FOR NAILER/STAPLER

- > **Secure the workpiece** (a workpiece clamped with clamping devices or in a vice is held more securely than by hand).
- > **Never push in the nailer/stapler head manually** (there is danger of injury when at the same time the trigger is activated unintentionally).
- > **Never use the tool for fastening electrical wiring** (contact with electrical wires can lead to fire and electric shock)
- > Avoid damage that can be caused by screws, nails and other elements in your workpiece; remove them before you start working.
- > Always check that the supply voltage is the same as the voltage indicated on the nameplate of the nailer/stapler (nailers/staplers with a rating of 230V or 240V can also be connected to a 220V supply).
- > In case of electrical or mechanical malfunction, immediately switch off the tool or unplug charger from power source.
- > We can assure flawless functioning of the tool only when original accessories are used.
- > This tool should not be used by people under the age of 16 years.
- > Do not expose tool to rain.

#### Operating the tool

- > Firmly press nailer/stapler head (4) against the workpiece until there is no gap between the nailer/stapler head (4) and the workpiece.
- > Briefly press trigger (5) and then release again.
- > Trigger (5) is locked as long as you do not press nailer/stapler head (4) against the workpiece, thus preventing accidental operation.

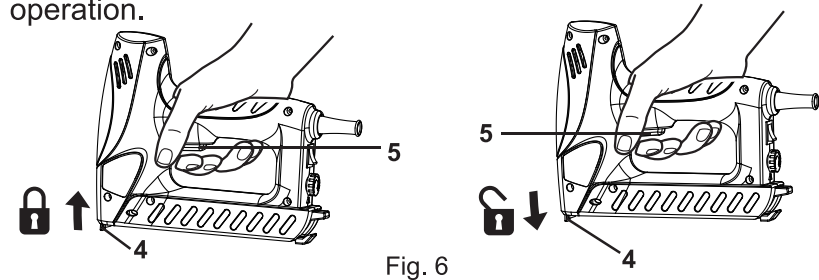

Fig. 6



**NOTE:** remove all staples/nails from the magazine after each use.

#### Impact control

- With wheel (2) the required impact level can be selected in steps.
- > Indicator (2) shows the selected impact level.
  - > “-” for thin and light materials such as foils and fabrics.
  - > “+” for thick and tough materials such as hard woods and walls.
  - > Before starting a job, find the optimal impact level by testing out on spare material.

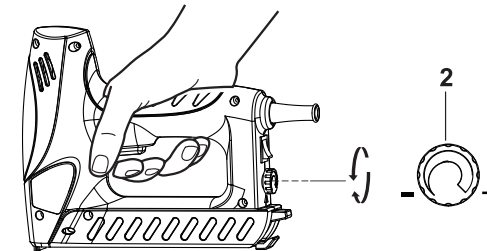

Fig. 7

## Intended use

The machine is intended for tacking of cardboard, insulating material, fabric, thin plywood, foils, leather and similar materials and similar materials on wooden surfaces or similar e.g. mdf, plywood; when used in accordance with these instructions. The machine is not suitable for the attachment of wall and ceiling panelling.

Any use beyond these parameters (different media, applied force) or any changes to the product (use on non original accessories, alteration etc) can lead to serious risks and is regarded as use that is contrary to the intended purpose. The operator is liable for any damage caused by improper use, and all main function warranty will be valid.

## Loading staples and nails

- > Switch off and unplug before insert nails, turn tool upside down (Fig. 4).
- > Press lever (1) while pulling state nail guage (7) backwards.
- > Insert the staple/nail strip into magazine (6) with points facing upward (maximum capacity 100 staples).
- > Push into magazine state nail guage (7) against nailer/stapler head (4) until it snap locks.
- > When inserting a nail strip tilt the tool in such a way, that the nail strip rests against the magazine side which corresponds with the nail symbol on nailer/stapler head (4) (Fig. 5) nail points upward.

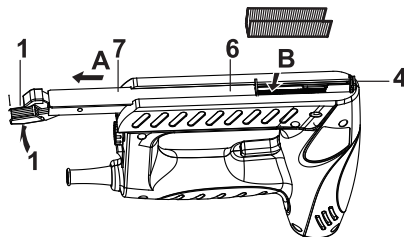

Fig. 4

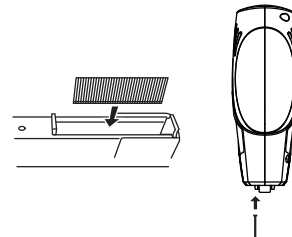

Fig. 5



**IMPORTANT:** Use Staples: TACWISE Types 53  
Nails: TACWISE 18ga Straight Nails. Max Length 15mm.

## Unpack

- > Unpack all parts and lay them on a flat, stable surface.
- > Remove all packing materials and shipping devices if applicable.
- > Make sure the delivery contents are complete and free of any damage. If you find that parts are missing or show damage do not use the product but contact your dealer. Using an incomplete or damaged product represents a hazard to people and property.
- > Ensure that you have all the accessories and tools needed for assembly and operation. This also includes suitable personal protective equipment.

## You will need

(items not supplied)  
Suitable personal  
protective equipment

(items supplied)  
Staples (14mm) (100pcs)  
Nails (15mm) (80pcs)

## Inserting Staples

Only use the nails/staples which are outlined in the technical specifications. Please keep in mind that staples and nails must be suited to the material they are used in. The harder the material is, the shorter the staples or nails should be.

1. Switch off and unplug the unit before inserting staples.
2. Turn the unit upside down.
3. Press the lever (1) in direction of the state nail guage (7) and pull out the magazine slider.
4. Insert a strip of staples (max. 100 staples) with the clip facing down and points upward into the magazine (Fig. 1).
5. Push in the magazine slider as far as it will go until the lever (1) audibly snaps in.

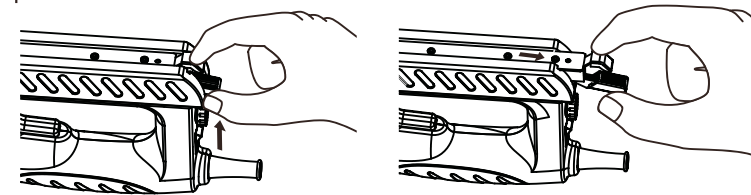

Fig. 1

## Inserting Nails

1. Switch off and unplug the power cord before inserting nails into the electric stapler.
2. Turn the unit upside down.
3. Press the lever (1) in direction of the state nail gauge (6) and pull out the magazine slider
4. Tilt the device and insert a strip of nails into the magazine, the points of nail should be upward. Pay attention to insert it in such a way that the nail strip rests against the left side of the magazine (seen from above) which corresponds to the nail symbol printed on the housing of the tool (Fig. 2). The heads of the nails face into the tool.
5. Push in the magazine slider as far as it will go until the lever (1) audibly snaps in.

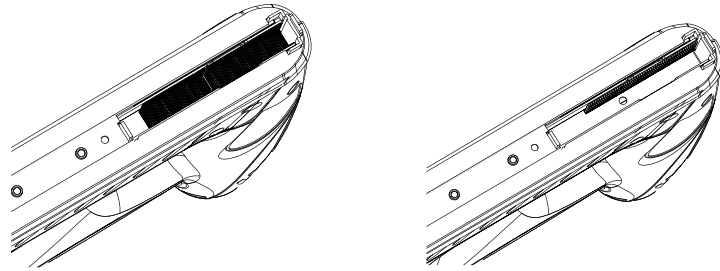

Fig. 2



## In more detail...

<b>Product functions</b>	13
<b>Care and maintenance</b>	15
<b>Trouble shooting</b>	18
<b>Recycling and disposal</b>	19
<b>EC declaration of conformity</b>	20