

GHFFX60SS1

60CM BUILT IN GAS HOB

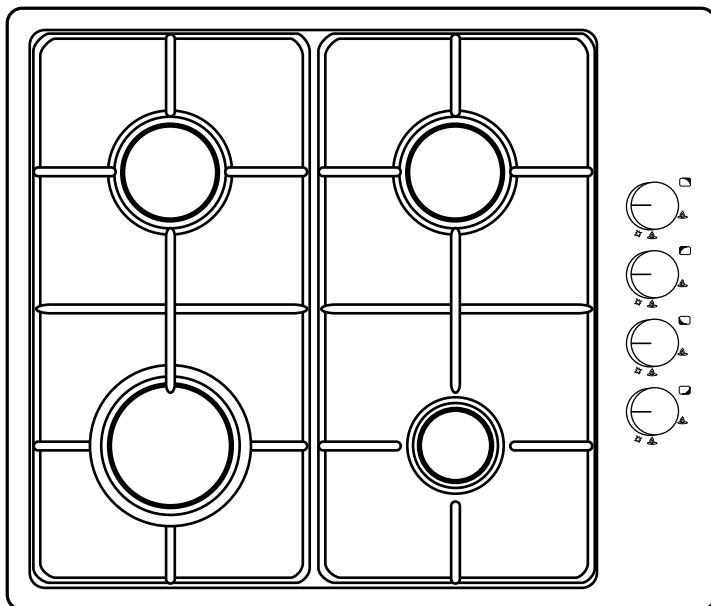

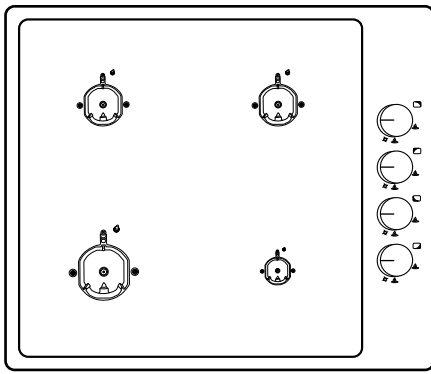

[01] x 1

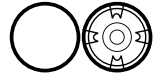

[02] x 1

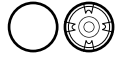

[03] x 2



[04] x 1

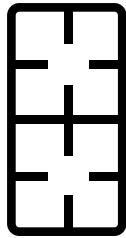

[05] x 2

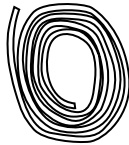

[06] x 1

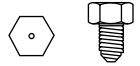

[08] x 4



[09] x 4 (4 x 25 mm)



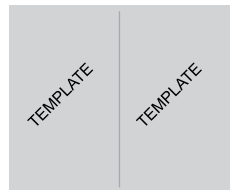

[07] x 4



[10] x 1

Let's get started...

These instructions are for your safety. Please read through them thoroughly before use and retain them for future reference.

	Getting started...	04
	Your product	04
	Before you start	04
	Safety	05
	In more detail...	09
	Operation	09
	Care and maintenance	12
	Troubleshooting	13
	Recycling and disposal	13
	Technical and legal information	14
	Guarantee	20
	CE Declaration of conformity	22
	Appendix...	
	Installation	23

Your product

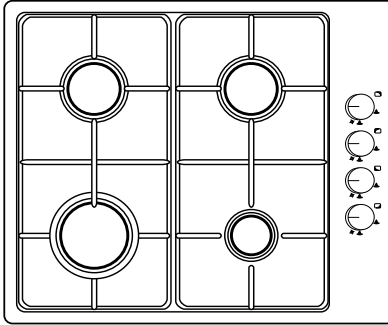

Installation guide
located at the end of
the guidebook

Things to check before you start

- To avoid the risks that are always present when you use an electrical appliance it is important that this appliance is installed correctly and that you read the safety instructions carefully to avoid misuse and hazards. Please keep this instruction booklet for future reference and pass it on to any future owners. After unpacking the appliance please check that it is not damaged. If in doubt, do not use the appliance but contact Customer Services on 0344 800 1128 (UK), 0144 75261 (Ireland).
- Check the package and make sure you have all of the parts listed.
- Decide on the appropriate location for your product.
- The specifications plate is available on this appliance. This plate displays all the necessary identification information for ordering replacement parts.
- If you sell the appliance, give it away, or leave it behind when you move house, make sure you also pass on this manual so that the new owner can become familiar with the appliance and its safety warnings.
- class of device: Class 3

You will need



These instructions are for your safety. Please read through them thoroughly prior to installation and retain them for future reference.



- All installation work must be carried out by a competent person or qualified electrician.
 - This appliance must be installed correctly by a suitably qualified person, strictly following the manufacturer's instructions.
- This appliance complies with all current European safety legislation, however, the Manufacturer must emphasise that this compliance does not prevent the surfaces of the appliance from heating up during use and remaining hot during its operation.
 - Accessible parts may become hot during use. Young children should be kept away. Care should be taken to avoid touching the appliance.
 - The Manufacturer highly recommends that this appliance be kept out of the reach of babies and small children.

- ☑ This appliance can be used by children aged from 8 years and above and persons with reduced physical, sensory or mental capabilities or lack of experience and knowledge if they have been given supervision or instruction concerning use of the appliance in a safe way and understand the hazards involved. Children shall not play with the appliance. Cleaning and user maintenance shall not be made by children unless they are older than 8 and supervised.
- ☑ Keep the appliance and its cord out of reach of children less than 8 years.
- ☑ Means for isolating the appliance must be incorporated in the fixed wiring in accordance with the current wiring regulations. An all-pole disconnection switch having a contact separation of at least 3 mm in all poles should be connected in fixed wiring.
- ☑ If the supply cord is damaged, it must be replaced by the manufacturer, its service agent or similarly qualified persons in order to avoid a hazard.
- ☑ Make sure that the power cord is not caught under or in the appliance and avoid damage to the power cable.

- ☑ Do not allow the electric cables to touch the hot parts of the appliance.
- ☑ Do not install the appliance outdoors in a damp place or in an area which may be prone to water leaks such as under or near a sink unit. In the event of a water leak allow the machine to dry naturally.
- ☑ Please dispose of the packing material carefully.
- ☑ Do not use flammable sprays in close vicinity to the appliance.
- ☑ We also recommend that great care be taken during use and cleaning. Read the cleaning and maintenance sections for this appliance carefully.
- ☑ A steam cleaner is not to be used.
- ☑ The appliance is not intended to be operated by means of external timer or separated remote-control system.
- ☑ The appliance is for domestic use only.
- ☑ When a cooking zone has been on for a long time, the surface remains hot for some time afterwards so do not touch the metal surface.
- ☑ Do not store detergents or flammable materials beneath the hob.
- ☑ Do not leave hot oils or fats unattended as they may catch light.

- ☑ The Manufacturer declines all liability for personal or material damage as a result of misuse or incorrect installation of this appliance.
- ☑ **Warning!** Unattended cooking on a hob with fat or oil can be dangerous and may result in fire.
- ☑ Never try to extinguish a fire with water, but switch off the appliance and then cover flame e.g. with a lid or a fire blanket.
- ☑ **Warning! Risk of fire!** Do not store items on the cooking surfaces.
- ☑ Prior to installation, ensure that the local distribution conditions (nature of the gas and gas pressure) and the adjustment of the appliance are compatible.
- ☑ The adjustment conditions for this appliance are stated on the label (or data plate).
- ☑ This appliance is not connected to a combustion products evacuation device. It shall be installed and connected in accordance with current installation regulations. Particular attention shall be given to the relevant requirements regarding ventilation.
- ☑ **CAUTION:** This appliance is for cooking purposes only. It must not be used for other purposes, for example room heating.
- ☑ The use of inappropriate hob guards can cause accidents.

Product functions

- 4 x burners: Four zones of cooking.
- Flame safety device (FSD): Stops the gas supply to the gas hob when the flame goes out.
- Auto ignition.
- LPG conversion kit supplied.

Control elements

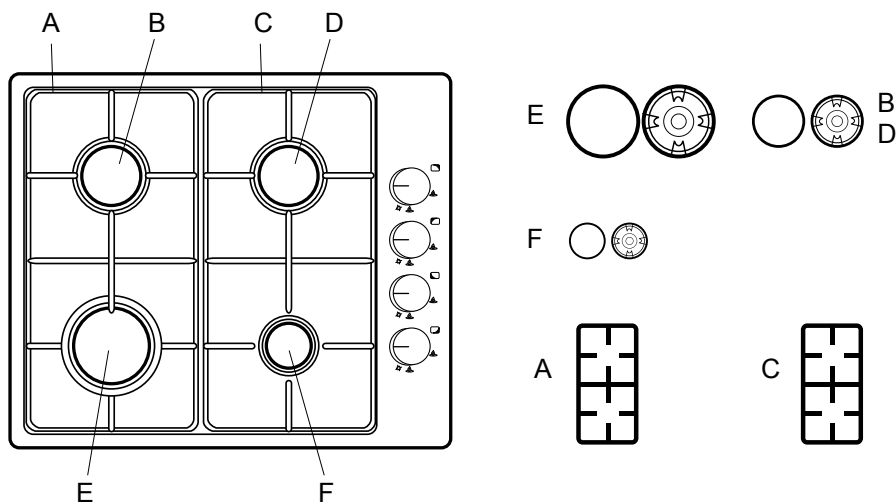

Reference	Description	Qty
A	Left pan support	1
B	Semi-rapid burner	1
C	Right pan support	1
D	Semi-rapid burner	1
E	Rapid burner	1
F	Auxiliary burner	1

Note: This diagram may be slightly different from the layout of the appliance.

Remark: There are plastic protective parts under the base of the pan support. There is no need to remove the plastic parts during use.

Operation

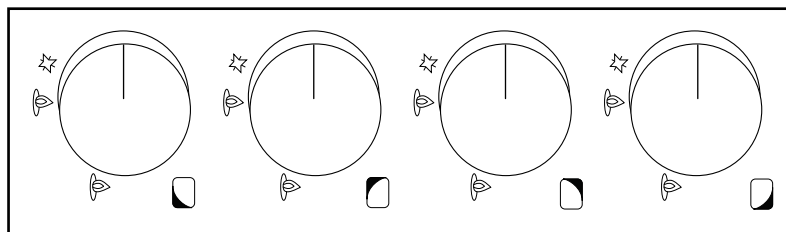

Use of the burners



Caution

- If there is no electric current you can light the burners with piezo electric spark gas ignitor.
- The burners can only be lit with safety thermocouples when the knob is on **MAXIMUM**.
- If ignition is failed for the first time, then we should wait for 5 mins before we try again.

On the right bottom side of each knob on the control panel there is a diagram to indicate the burner to which the knob refers to. The burners can be switched on in several ways, according to the type of appliance and its individual features.

Manual “ON” switch (this is always possible even if the electric current is off):

- Turn the knob corresponding to the selected burner in a counter-clockwise direction so that the knob is at **MAXIMUM** (this corresponds to a large flame).
- Use a piezo electric spark gas ignitor.

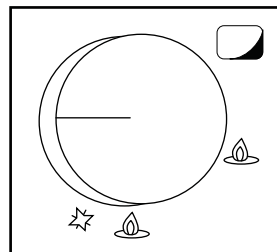

Automatic electric “ON” switch for burners with safety device (thermocouples):

- Turn the knob corresponding to the selected burner in a counter-clockwise direction so that the knob is at **MAXIMUM**.
- Once the burner is lit, keep the knob pressed in for about 10 seconds in order to allow the flame to heat up the thermocouple. If the burner goes out when the knob is let go, repeat the operation.

Operation

Note



- The use of a gas cooking appliance produces heat and humidity in the place where it is installed.
- Therefore, you need to ensure the place is well ventilated, keeping the natural ventilation openings clear and using a mechanical ventilation device/ flue or electric fan.
- Intensive or prolonged use of the appliance may require additional ventilation, such as opening a nearby window or increased ventilation efficiency obtained by increasing the power of the mechanical ventilators, where applicable.
- This appliance is only for flat bottomed pans.

Advice for the best use of the burner:

- When boiling point is reached, turn the knob to MINIMUM.
- Always use pans with a lid.

Burner	Recommended pan diameters (cm)
Auxiliary	12-14
Semi-rapid	14-26
Rapid	18-26

Care and maintenance



Warning

Always switch off the electricity supply before performing maintenance work. In the event of a fault, contact customer services.

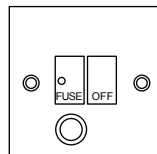

Caution

- Use soapy water and a cloth for cleaning. Never use abrasive powders.
- Avoid banging pots and pans down on the hob.
- Do not leave any empty pan on the heating zone.

- The appliance should be cleaned after use.
- Wipe the inner and outer surface of the appliance and its accessories with wet cloth.
- Any liquid overflowing from the pan must always be removed with a cloth.
- The surface of the hob may be easily cleaned as follows:

Cleaning of enamel parts:

To maintain the features of the enamel parts, wash frequently with soapy water. Never use abrasive powders. Avoid leaving acid or alkaline substances on the enamel parts (vinegar, lemon juice, salt, tomato juice, etc.) and washing the enamel parts while they are still warm.

Cleaning of stainless steel parts:

Wash these parts with soapy water and then dry them with a soft cloth. The shine is maintained by regularly cleaning them with special products normally commercially available. Never use abrasive powders.

Cleaning of burner flame dividers:

Given that they are not fixed, the flame dividers can be cleaned by simply removing them and washing them with soapy water. After drying them well and checking that the holes are not blocked, put them back into their correct position.

Replacement of parts

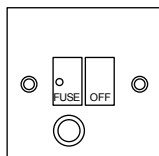

Warning

Always switch off the electricity supply before performing maintenance work. In the event of a fault, contact customer services.

Troubleshooting

The following circumstances may not be a problem. Do not contact the customer services until the problem has been confirmed.

If your appliance is still not functioning properly after making the above checks, please contact customer services.

1. Check that the mains supply has not been switched off.
2. Check that the fuse in the spur has not blown.
3. Ensure that the burner components are not excessively soiled as this can lead to ignition problems.

Do not take the appliance apart yourself, as you may damage the hob.

Before calling After Sales Service, please do the following:

1. Check that the appliance is correctly connected.
2. Read the failure text above. If you are still unable to solve the problem, switch off the appliance, do not try to take it apart and call customer services.

Recycling and disposal

Environmental protection

Waste electrical products should not be disposed of with household waste. Please recycle where facilities exist. Check with your Local Authority or retailer for recycling advice.



The symbol on the product or its packaging indicates that this product cannot be treated as normal household waste. This product must be handed over to an electric and electronic equipment collection point for recycling.

On ensuring that this product is disposed of correctly, you will help to avoid possible negative consequences for the environment and public health, which could occur if this product is not handled correctly. To receive more detailed information about recycling this product, contact your local government, domestic waste disposal services or the outlet where the product was bought.

Technical specifications

Supply voltage	220-240V~, 50/60Hz
Gas pressure	G20Type/20mabr/7.5kw, G30Type/28-30mbar/7.5kw
External dimensions (W x H x D)	590 x 90 x 500 mm
Net weight	7.3kg

USER CHARACTERISTICS

BURNER TYPE	MAX OUTPUT	MIN OUTPUT	G20 20mbar		G30 28-30mbar		Cooking zone
	Kw	Kw	Nozzle size (mm)	Cons M ³ /h	Nozzle size (1/100mm)	Cons g/h	
Small Auxiliary burner	1.00	0.35	0.72	0.095	- 50	73	F
Medium Semi-rapid Burner	1.75	0.65	0.97	0.167	- 65	127	B and D
Large rapid burner	3.0	1.0	1.15	0.286	- 85	218	E

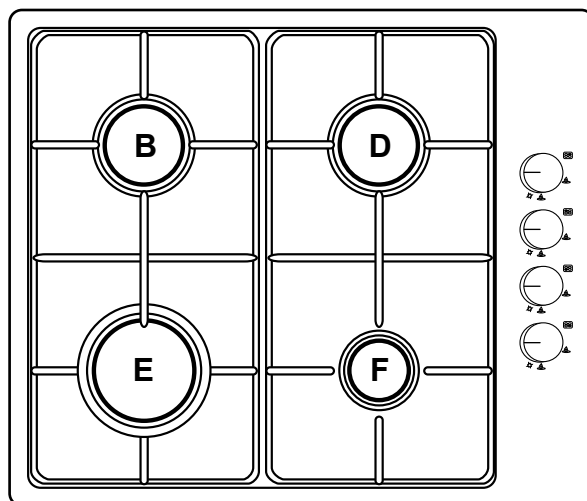

Wiring

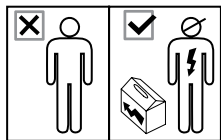

All installation work must be carried out by a competent person or qualified electrician.
Before connecting the mains supply ensure that the mains voltage corresponds to the voltage on the rating plate inside the cooker hob.



WARNING: THIS APPLIANCE MUST BE EARTHED.

Mains Supply could be connected to the Mains Voltage by Direct Connection

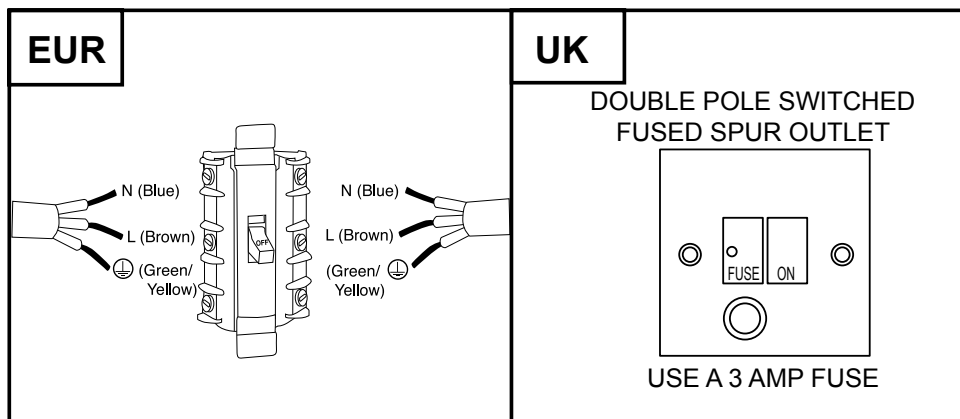

Direct Connection

If the appliance is being connected directly to the mains an omnipolar circuit-breaker must be installed with a minimum opening of 3mm between contacts.

The installer must ensure that the correct electrical connection has been made and that it complies with wiring diagram.

The cable must not be bent or compressed.

Regularly check the power plug and power cord for damage. If the supply cord is damaged, it must be replaced by a special cord or assembly available from the manufacturer or its service agent.

Technical and legal information

The Manufacturer declines all liability for damage caused to persons and objects due to incorrect or improper installation of the appliance.

Electrical Requirements

Any permanent electrical installation must comply with the latest I.E.E. Regulations and local electricity company regulations. For your own safety a qualified electrician or contractor who is on the roll of the National Inspection Council for Electrical Installation Contracting (NICEIC) should undertake the electrical installation.

Electrical Connection

Before connecting the mains supply ensure that the mains voltage corresponds to the voltage on the rating plate inside the appliance.



WARNING: THIS APPLIANCE MUST BE EARTHED

The appliance is supplied with a 3-core mains cable and must be connected to the electricity supply via a double pole switch having a 3mm minimum contact gap on each connector.

For UK only

A Switched Fused Connection Unit to BS 1363 Part 4 is recommended.

The fuse must be rated at 3 Amps.

The wires in the mains lead are coloured in accordance with the following code:

Brown = L - Live

Blue = N - Neutral

Green/Yellow = ⊕ - Earth

The connection point must be placed in a position adjacent to the appliance so as to be readily accessible for an engineer in the event of a breakdown.

Installation guidelines

Gas supply requirements

The appliance installation must be carried out in accordance with relevant local regulations.

The installation must be carried out by an authorised gas appliance installer and tested to local regulations.

We are not legally able to offer advice on the installation of gas appliances to un-authorised personnel.

Ventilation

All rooms require a window or equivalent (e.g. a door) which can be opened. Some rooms require a permanent vent or extractor in addition to a window (see below).

This unit must not be used in a room which is less than 5m³. The following table details the requirements based on the kitchen volume (L x W x H) in m³.

The above requirements also allow use of a gas oven and grill but if there are any other fuel burning appliances in the same room, consult the relevant British Standard (BS5440) or Gas Safe manual.

Room Volume (m ³)	Air vent required (cm ³)
5	100
6 to 10	50
6 to 11	No permanent vent required if a door opens to the outside
11 or more	None required

The above requirements also allow use of a gas oven and grill but if there are any other fuel burning appliances in the same room, consult the relevant British Standard (BS440) or Gas Safe document.

What you should do if you smell gas?

Switch off the gas supply

Open doors and windows

UK: Call Transco 0800 111 999

ROI: Call Irish Gas Board

Gas connection



Caution

The gas connection must be installed in compliance with applicable regulations in the country of installation.

The preferred method of connection is by rigid copper pipe or by flexible hose, depending on local regulations. The hob is supplied with a G $\frac{1}{2}$ " elbow that can be used or discarded depending on approved method of connection and best engineering practice.

Changing the nozzles



Caution

The hob installation and burner changes must be carried out by a competent person, e.g. a gas safe registered fitter.



Note

The LPG nozzles are provided in a separate bag marked "LPG" and if they are changed and the natural gas jets retained then the label should be changed to "NATURAL".

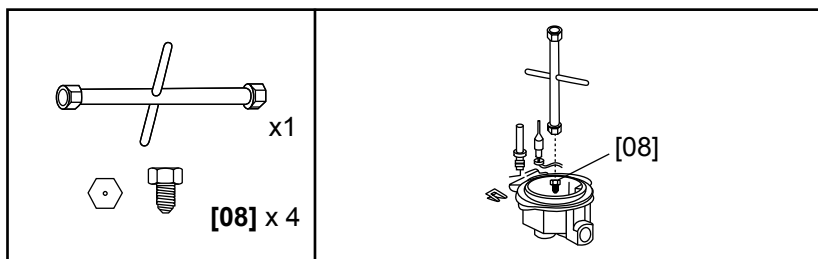

Lift up the burners and unscrew the nozzle using a dedicated tool and replace the nozzles with those designed for LPG gas supply.

Gas connection

Regulation of burners



Caution

The regulation described can only be carried out with burners that use methane gas and city gas (where available), whereas the screw must be fully tightened in a clockwise direction on burners using liquid gas.

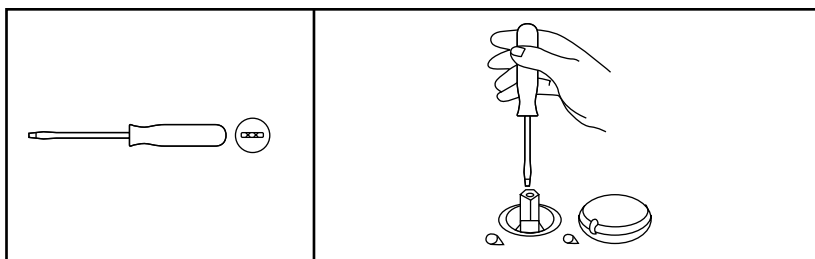

Regulation of the "MINIMUM" position on the burners.

To regulate the minimum position on the burners, follow the procedure below:

1. Turn on the burner and turn the knob to its MINIMUM position (small flame).
2. Remove the knob from the tap set for standard pressure. The knob is found on the bar of the tap itself.
3. Place the tap bar on the work top, use a small screwdriver that fits the (gold) screws located at the lower part of the tap and turn the fixing screw to the right or left until the flame of the burner is regulated in the most suitable manner to MINIMUM.
4. Make sure that the flame does not go out when changing the position quickly from MAXIMUM to MINIMUM position.
5. The minimum flame height is 15mm.



Caution

End User should not adjust "Minimum" position on the burner by themselves. It can only be adjusted by qualified technician according to relative standard.

Guarantee

This appliance is covered by a full manufacturer's 2 year parts and 2 year labour guarantee and covers all parts and labour costs associated with the repair of the appliance in a domestic environment. We will repair any defect that arises due to faulty materials or workmanship and use genuine manufacturers parts.

All claims must be supported with the original receipt or other reasonable proof of purchase.

If, during the guarantee period, the appliance becomes irreparable as agreed by the engineer approved by GAA then we reserve the right, at our discretion, to exchange the defective product with a replacement appliance at GAA's sole cost. If the same product is no longer available an alternative will be offered with the same functions as the faulty item.

After an appliance has been repaired or replaced any remaining balance of the GAA guarantee will be valid and any further call outs during this prescribed period will be covered by GAA on the replacement appliance.

Should any person other than an authorized engineer modify or attempt to repair the appliance then the warranty will be invalid.

The guarantee applies to the UK mainland, Scotland, Ireland, ROI and France but is not transferable between EU countries.

This guarantee is non-transferable to any other person or product. The guarantee is covered by UK law and is in addition to and does not diminish your legal rights.

Extended parts only warranty

As testimony to our commitment to you as a valued customer of Cooke & Lewis, we will offer you an additional 3 years parts warranty absolutely free.

If during the extended parts warranty period the appliance fails and it is considered uneconomical to repair our Customer Service Department will offer you the opportunity to purchase the same or equivalent model at a discounted price.

All parts supplied free of charge under the extended warranty must be fitted by our approved engineers and will be subject to a call out charge to fit the part.

Guarantee

Exclusions to the guarantee

This guarantee does NOT cover:

Appliances that have been damaged or neglected as a result of failure to store, assemble, install, use or care of the products in accordance with the manufacturer's instructions - GAA will not accept responsibility under this guarantee if a product is damaged or becomes defective due to, misuse, neglect, wilful or accidental damage or act of god.

Normal wear and tear.

Consumable items such as carbon filters and bulbs.

Claims arising from non-domestic use or commercial environment.

Any gas appliance not fitted by a gas safe qualified installer.

If no fault is found then GAA reserves the right to charge for the call out at the going rate.

In the course of the service work carried out it may be necessary to remove the built in appliance from its fitted position. If the appliance is glued, grouted or tiled in such a manner that it cannot be removed, it is the responsibility of the customer/installer to remove and reinstall the appliance to facilitate the repair.

This Guarantee does not affect your statutory rights.

The guarantee is offered by GAA Ltd, 1301-1303 Lu Plaza, 2 Wing Yip St, Kwun Tong, Kowloon, Hong Kong.

Customer Service

To arrange an in guarantee service call, please contact customer services on the following numbers.

UK & Northern Ireland
Phone: 0344 800 1128
Email: uksupport@apelson.co.uk
Web: www.myspareparts.co.uk

Republic of Ireland (Eire)
Phone: 014475261

CE Declaration of Conformity



MANUFACTURER: CATA

ADDRESS: C/ Ter nº 2, Torelló 08570 - Barcelona (Spain)

We hereby certify that the mentioned accessory complies with the essential requirements of the European Directives applicable, including their modifications and the corresponding transpositions from the national law.

MACHINE APPLICATION: GHFFX60SS1

TYPE: Built-in Gas Hob

EC DIRECTIVES APPLIED: Comply with the following European Directives 2006/95/CE:
LVD (Low Voltage Directive) and the 2004/108/CE:
EMC (Electromagnetic Conformity)

APPLIED HARMONIZED STANDARDS:

Standard EN 60335-2-102:2006

Standard EN 60335-1:2002 + A1:2004 + A12:2006 + A2:2006

Standard EN 50366:2003 + A1:2006

APPLIED INTERNATIONAL TECHNICAL

STANDARDS AND SPECIFICATIONS: ISO9001.2008

PLACE: Torelló

David Sala

Technical Manager

The Manufacturer has a policy of continuous product improvement, it reserves the right to adapt and carry out any modification considered necessary without prior warning.

Clearance



Warning

Good ventilation is required around the appliance for easier dissipation of heat and low power consumption. Sufficient clearance is required around the appliance. The gap between the hob and any cupboard above it should be at least 650mm.

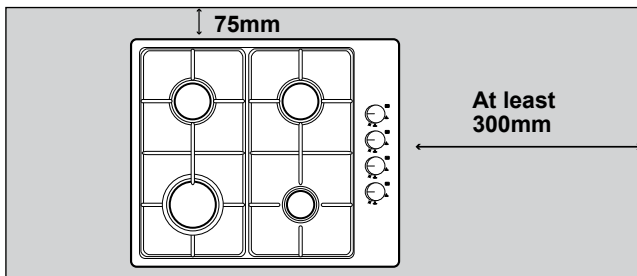
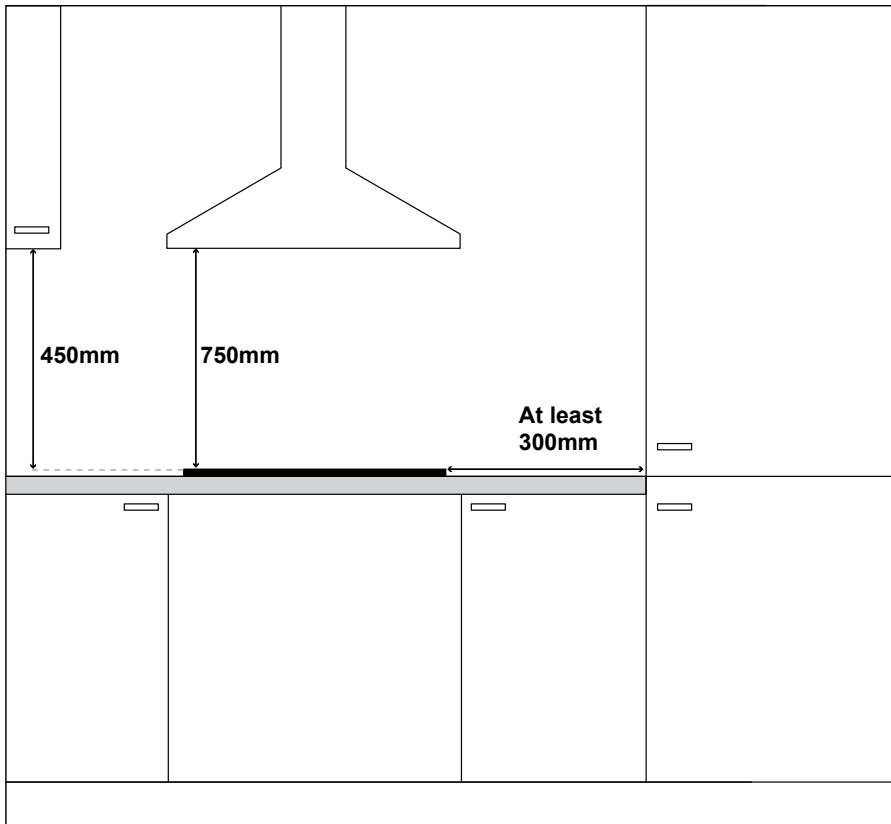

01



[10] x 1

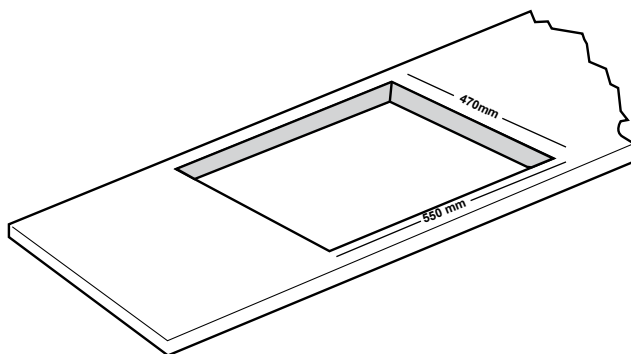

Cut out worktop to the template dimensions with suitable equipment.

02

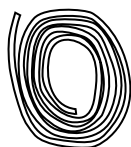

[06] x 1

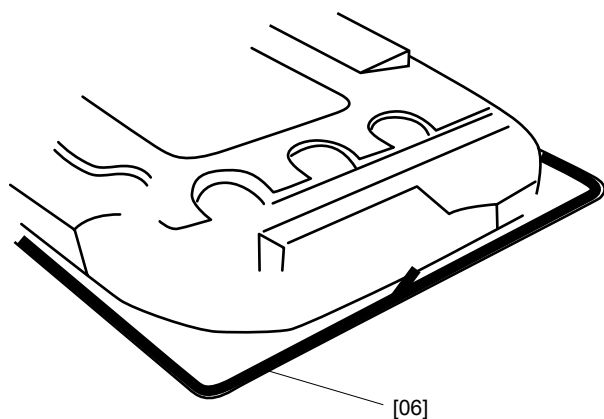

Stretch out the supplied seal along the underside edge of the hob, ensuring the ends overlap.

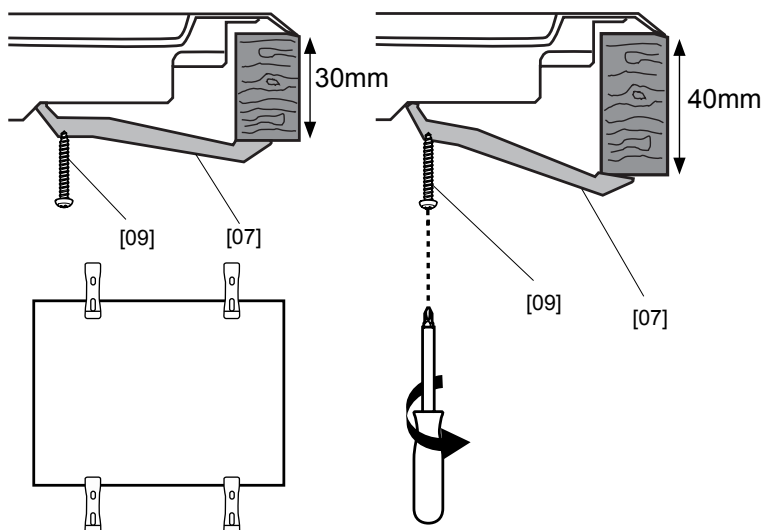
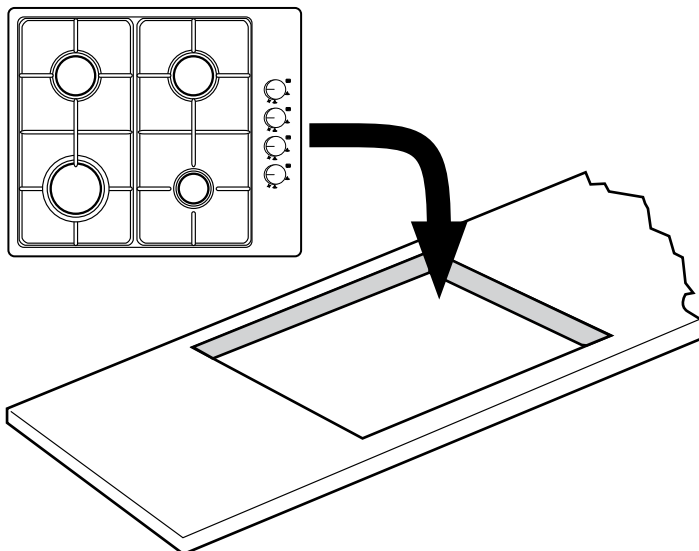

Note: For electrical connection see *Technical and legal information* section.



GAA Ltd
1301-1303 1Lu Plaza 2 Wing Yip St
Kwun Tong
Kowloon
Hong Kong
