

Robert Bosch GmbH
Power Tools Division
70745 Leinfelden-Echterdingen
Germany

www.bosch-garden.com

F 016 L70 833 (2012.04) O / 12 XXX



AHS

45-26 | 50-26 | 55-26 | 60-26 | 65-34 | 70-34



en Original instructions



2 | English

English

Safety Notes

Explanation of symbols



Read instruction manual.



Do not use the hedgecutter in the rain or leave it outdoors when it is raining.



Switch off and remove plug from mains before adjusting, cleaning or if the cable is entangled or if the cable is cut or damaged and before leaving the hedgecutter unattended for any period.



Wear ear protection.

General Power Tool Safety Warnings



Read all safety warnings and all instructions. Failure to follow the warnings

and instructions may result in electric shock, fire and/or serious injury.

Save all warnings and instructions for future reference.

The term "power tool" in the warnings refers to your mains-operated (corded) power tool or battery-operated (cordless) power tool.

Work area safety

- ▶ **Keep work area clean and well lit.** Cluttered or dark areas invite accidents.
- ▶ **Do not operate power tools in explosive atmospheres, such as in the presence of flammable liquids, gases or dust.** Power tools create sparks which may ignite the dust or fumes.
- ▶ **Keep children and bystanders away while operating a power tool.** Distractions can cause you to lose control.

Electrical safety

- ▶ **Power tool plugs must match the outlet. Never modify the plug in any way. Do not use any adapter plugs with earthed (grounded) power tools.** Unmodified plugs and matching outlets will reduce risk of electric shock.
- ▶ **Avoid body contact with earthed or grounded surfaces, such as pipes, radiators, ranges and refrigerators.** There is an increased risk of electric shock if your body is earthed or grounded.
- ▶ **Do not expose power tools to rain or wet conditions.** Water entering a power tool will increase the risk of electric shock.
- ▶ **Do not abuse the cord. Never use the cord for carrying, pulling or unplugging the power tool. Keep cord away**

from heat, oil, sharp edges and moving parts. Damaged or entangled cords increase the risk of electric shock.

- ▶ **When operating a power tool outdoors, use an extension cord suitable for outdoor use.** Use of a cord suitable for outdoor use reduces the risk of electric shock.
- ▶ **If operating a power tool in a damp location is unavoidable, use a residual current device (RCD) protected supply.** Use of an RCD reduces the risk of electric shock.

Personal safety

- ▶ **Stay alert, watch what you are doing and use common sense when operating a power tool. Do not use a power tool while you are tired or under the influence of drugs, alcohol or medication.** A moment of inattention while operating power tools may result in serious personal injury.
- ▶ **Use personal protective equipment. Always wear eye protection.** Protective equipment such as dust mask, non-skid safety shoes, hard hat, or hearing protection used for appropriate conditions will reduce personal injuries.
- ▶ **Prevent unintentional starting. Ensure the switch is in the off-position before connecting to power source and/or battery pack, picking up or carrying the tool.** Carrying power tools with your finger on the switch or engaging power tools that have the switch on invites accidents.
- ▶ **Remove any adjusting key or wrench before turning the power tool on.** A wrench or a key left attached to a rotating part of the power tool may result in personal injury.
- ▶ **Do not overreach. Keep proper footing and balance at all times.** This enables better control of the power tool in unexpected situations.
- ▶ **Dress properly. Do not wear loose clothing or jewelry. Keep your hair, clothing and gloves away from moving parts.** Loose clothes, jewellery or long hair can be caught in moving parts.
- ▶ **If devices are provided for the connection of dust extraction and collection facilities, ensure these are connected and properly used.** Use of dust collection can reduce dust-related hazards.

Power tool use and care

- ▶ **Do not force the power tool. Use the correct power tool for your application.** The correct power tool will do the job better and safer at the rate for which it was designed.
- ▶ **Do not use the power tool if the switch does not turn it on and off.** Any power tool that cannot be controlled with the switch is dangerous and must be repaired.
- ▶ **Disconnect the plug from the power source and/or the battery pack from the power tool before making any adjustments, changing accessories, or storing power tools.** Such preventive safety measures reduce the risk of starting the power tool accidentally.
- ▶ **Store idle power tools out of the reach of children and do not allow persons unfamiliar with the power tool or these instructions to operate the power tool.** Power tools are dangerous in the hands of untrained users.

- ▶ **Maintain power tools. Check for misalignment or binding of moving parts, breakage of parts and any other condition that may affect the power tool's operation. If damaged, have the power tool repaired before use.**

Many accidents are caused by poorly maintained power tools.

- ▶ **Keep cutting tools sharp and clean.** Properly maintained cutting tools with sharp cutting edges are less likely to bind and are easier to control.
- ▶ **Use the power tool, accessories and tool bits etc. in accordance with these instructions, taking into account the working conditions and the work to be performed.** Use of the power tool for operations different from those intended could result in a hazardous situation.

Battery tool use and care

- ▶ **Recharge only with the charger specified by the manufacturer.** A charger that is suitable for one type of battery pack may create a risk of fire when used with another battery pack.
- ▶ **Use power tools only with specifically designated battery packs.** Use of any other battery packs may create a risk of injury and fire.
- ▶ **When battery pack is not in use, keep it away from other metal objects, like paper clips, coins, keys, nails, screws or other small metal objects, that can make a connection from one terminal to another.** Shorting the battery terminals together may cause burns or a fire.
- ▶ **Under abusive conditions, liquid may be ejected from the battery; avoid contact. If contact accidentally occurs, flush with water. If liquid contacts eyes, additionally seek medical help.** Liquid ejected from the battery may cause irritation or burns.

Service

- ▶ **Have your power tool serviced by a qualified repair person using only identical replacement parts.** This will ensure that the safety of the power tool is maintained.

Hedge trimmer safety warnings

- ▶ **Keep all parts of the body away from the cutter blade. Do not remove cut material nor hold material to be cut when blades are moving. Make sure the switch is off when clearing jammed material.** A moment of inattention while operating the hedge trimmer may result in serious personal injury.
- ▶ **Carry the hedge trimmer by the handle with the cutter blade stopped. When transporting or storing the hedge trimmer always fit the cutting device cover.** Proper handling of the hedge trimmer will reduce possible personal injury from the cutter blades.
- ▶ **Hold the power tool by insulated gripping surfaces only, because the cutter blade may contact hidden wiring or its own cord.** Cutter blades contacting a "live" wire may make exposed metal parts of the power tool "live" and could give the operator an electric shock.

- ▶ **Keep cable away from cutting area.** During operation the cable may be hidden in shrubs and can be accidentally cut by the blade.

Additional safety warnings

- ▶ This tool is not intended for use by persons (including children) with reduced physical, sensory or mental capabilities, or lack of experience and knowledge, unless they have been given supervision or instruction concerning use of the appliance by a person responsible for their safety. Children should be supervised to ensure that they do not play with the appliance.
- ▶ **When working with the machine, always hold it firmly with both hands and provide for a secure stance.** The power tool is guided more secure with both hands.
- ▶ **Wait until the machine has come to a standstill before placing it down.**
- ▶ Other persons and animals should remain at a distance of 3 metres or more when the machine is being used. The operator is responsible for third persons in the working area.
- ▶ Never grasp the blade of the hedgecutter.
- ▶ Children or persons unfamiliar with these instructions must not operate the hedgecutter. Local regulations may restrict the age of the operator.
- ▶ Never cut a hedge while people, especially children or pets, are nearby.
- ▶ The operator or user is responsible for accidents or hazards occurring to other people or their property.
- ▶ Do not operate the hedgecutter when barefoot or wearing open sandals, always wear substantial footwear and long trousers. The use of sturdy gloves, non-skid footwear and safety glasses is recommended. Do not wear loose clothing or jewellery which can be caught in moving parts.
- ▶ Thoroughly inspect the area where the hedgecutter is to be used and remove all wires and other foreign objects.
- ▶ Prior to operation, check cutter blades, blade bolts and cutter assembly for wear or damage. Do not operate with a damaged or excessively worn cutting device.
- ▶ Check cable for damage before starting work and replace if necessary. Keep cable away from heat, oil and sharp edges.
- ▶ Know how to stop the hedgecutter quickly in an emergency.
- ▶ Cut a hedge only in daylight or in good artificial light.
- ▶ Never operate the hedgecutter with defective guards or without the guard in place.
- ▶ Always ensure all handles and guards supplied are fitted when using the hedgecutter. Never attempt to use an incomplete hedgecutter or one with an unauthorised modification.
- ▶ Never hold the hedgecutter by the guard.
- ▶ While operating the hedgecutter always be sure of a safe and secure operating position at all times, especially when using steps or a ladder.

4 | English

- ▶ Always be aware of your surroundings and stay alert for possible hazards that you may not hear whilst operating the hedgecutter.

Remove the plug from the socket:

- before checking, clearing a blockage or working on the hedgecutter.
- after striking a foreign object, inspect the hedgecutter for damage and make repairs as necessary.
- if the hedgecutter starts to vibrate abnormally check immediately.
- ▶ Keep all nuts, bolts and screws tight to ensure that the hedgecutter is always in a safe working condition.
- ▶ The hedgecutter should be stored in a dry, high or locked up place out of the reach of children.
- ▶ Replace worn or damaged parts for safety.
- ▶ Do not attempt to repair the machine unless you are qualified to do so.
- ▶ Ensure replacement parts fitted are Bosch approved.

Electrical Safety

- ▶ **Warning! Switch off, remove plug from mains before adjusting, cleaning or if cable is cut, damaged or entangled.**
- ▶ **The blades continue to move for a few seconds after the hedgecutter is switched off. Caution! Do not touch the moving blades.**

Your machine is double insulated for safety and requires no earth connection. The operating voltage is 230 V AC, 50 Hz (for non-EU countries 220 V, 240 V as applicable). Only use approved extension cables. Contact your Bosch Service Centre for details.

Extension cords/leads should only be used if they comply with H05VV-F or H05RN-F types.

It is recommended for increased electrical safety to use a Residual Current Device (RCD) with a tripping current of not more than 30 mA. Always check your RCD every time you use it.

For products **not sold in GB**:

WARNING: For your safety, it is required that the plug attached to the machine is connected with the extension cord. The coupling of the extension cord must be protected against splash water, be made of rubber or coated with rubber. The extension cord must be used with a cable strain relief.

The connection lead must be inspected for signs of damage at regular intervals and may only be used if in perfect condition. If the supply cord is damaged, it must be replaced by a Bosch Service Centre.

Products sold in GB only: Your product is fitted with an BS 1363/A approved electric plug with internal fuse (ASTA approved to BS 1362).

If the plug is not suitable for your socket outlets, it should be cut off and an appropriate plug fitted in its place by an authorised customer service agent. The replacement plug should have the same fuse rating as the original plug.

The severed plug must be disposed of to avoid a possible shock hazard and should never be inserted into a mains socket elsewhere.









Products sold in AUS and NZ only: Use a residual current device (RCD) with a rated residual current of 30 mA or less.

Maintenance

- ▶ Always wear gardening gloves when handling or working near the sharp blades.
- ▶ Examine the machine and replace worn or damaged parts for safety.
- ▶ Always lubricate the cutting blade with protective spray before storage.
- ▶ Keep all nuts, bolts and screws tight to be sure that the machine is in safe working condition.
- ▶ Ensure replacement parts fitted are Bosch approved.

Symbols

The following symbols are important for reading and understanding the operating instructions. Please take note of the symbols and their meaning. The correct interpretation of the symbols will help you to use the machine in a better and safer manner.

Symbol	Meaning
	Wear protective gloves
	Wear eye protection.
	Movement direction
	Switching On
	Switching Off
	Beware electric shock hazard.
	Permitted action
	Prohibited action
	Accessories

Intended Use

The machine is intended for cutting and trimming hedges and bushes in domestic use.

Technical Data

Hedgecutter		AHS 45-26	AHS 50-26	AHS 55-26	AHS 60-26
Article number	3 600 ...	H47 E..	H47 F..	H47 G..	H47 H..
Rated power input	W	550	600	600	600
Cutting length	mm	450	500	550	600
Tooth opening	mm	26	26	26	26
No-load stroke rate	min ⁻¹	3 400	3 400	3 400	3 400
Slipping Clutch Torque	Nm	50	50	50	50
Weight according to EPTA-Procedure 01/2003	kg	3.5	3.5	3.6	3.6
Protection class		□/II	□/II	□/II	□/II

The values given are valid for a nominal voltage [U] of 230 V. For different voltages and models for specific countries, these values can vary.

Please observe the article number on the type plate of your garden product. The trade names of the individual garden products may vary.

Hedgecutter		AHS 65-34	AHS 70-34
Article number	3 600 ...	H47 J..	H47 K..
Rated power input	W	700	700
Cutting length	mm	650	700
Tooth opening	mm	34	34
No-load stroke rate	min ⁻¹	3 400	3 400
Slipping Clutch Torque	Nm	50	50
Weight according to EPTA-Procedure 01/2003	kg	3.7	3.8
Protection class		□/II	□/II

The values given are valid for a nominal voltage [U] of 230 V. For different voltages and models for specific countries, these values can vary.

Please observe the article number on the type plate of your garden product. The trade names of the individual garden products may vary.

Noise/Vibration Information

Measured sound values determined according to EN 60745.	3 600 ...	H47 E.. H47 F.. H47 G.. H47 H..	H47 J.. H47 K..
Typically the A-weighted noise levels of the product are:			
Sound pressure level	dB(A)	75	76
Sound power level	dB(A)	96	97
Uncertainty K	dB	1	1
Wear hearing protection!			
Vibration total values a_h (triax vector sum) and uncertainty K determined according to EN 60745:			
a_h	m/s ²	2.5	4.0
K	m/s ²	1.5	1.5

The vibration emission level given in this information sheet has been measured in accordance with a standardised test given in EN 60745 and may be used to compare one tool with another. It may be used for a preliminary assessment of exposure.

The declared vibration emission level represents the main applications of the tool. However if the tool is used for different applications, with different accessories or poorly maintained, the vibration emission may differ. This may significantly increase the exposure level over the total working period.

An estimation of the level of exposure to vibration should also take into account the times when the tool is switched off or when it is running but not actually doing the job. This may significantly reduce the exposure level over the total working period.

Identify additional safety measures to protect the operator from the effects of vibration such as: maintain the tool and the accessories, keep hands warm, organise work patterns.

6 | English



Declaration of Conformity

3 600 ...	H47 E.. H47 F.. H47 G.. H47 H..	H47 J.. H47 K..
We declare under our sole responsibility that the product described under "Technical data" is in conformity with the following standards or standardization documents: EN 60745 according to the provisions of the directives 2011/65/EU, 2004/108/EC, 2006/42/EC, 2000/14/EC. 2000/14/EC: Guaranteed sound power level Conformity assessment procedure according to Annex V.	dB(A)	97
		98

Equipment category: 25

Technical file (2006/42/EC) at:
Bosch Lawn and Garden Ltd., PT-LG/ENS,
Stowmarket, Suffolk IP14 1EY, England

Dr. Egbert Schneider Helmut Heinzelmann
Senior Vice President Head of Product Certification
Engineering PT/ETM9

Robert Bosch GmbH, Power Tools Division
D-70745 Leinfelden-Echterdingen
12.04.2012

Action	Figure
Starting	3
Stopping	3
Working Advice	4
Sawing Function	5
Blade Maintenance	6
Storage and Transport	6
Selecting Accessories	7

Working Advice

Sawing Function

Although the tooth opening allows wood to be cut up to $\varnothing 26/34$ mm, the tip of the blade is designed to cut wood up to $\varnothing 32/38$ mm.

Mounting and Operation

Action	Figure
Delivery Scope	1
Connecting the Extension Lead	2

Troubleshooting



Problem	Possible Cause	Corrective Action
Hedgecutter does not operate	Power turned off	Turn power on
	Mains socket faulty	Use another socket
	Inbuilt supply cable damaged	Inspect supply cable carefully, contact Service Agent for replacement
	Separate extension cable damaged	Inspect extension cable, replace if damaged
Hedgecutter operates intermittently	Fuse faulty/blown	Replace fuse
	Inbuilt supply cable damaged	Inspect supply cable carefully, contact Service Agent for replacement
	Separate extension cable damaged	Inspect extension cable, replace if damaged
	Internal wiring of garden product damaged	Contact Service Agent
Motor runs but blades remain stationary	On/Off switch defective	Contact Service Agent
	Internal fault	Contact Service Agent

Problem	Possible Cause	Corrective Action
Cutting blade hot	Cutting blade blunt	Have blade sharpened
	Cutting blade has dents	Have blade inspected/overhauled
	Too much friction, due to lack of lubricant	Apply lubricant spray
Excessive vibrations/noise	Garden product defective	Contact Service Agent

After-sales Service and Customer Assistance

www.bosch-garden.com

In all correspondence and spare parts order, please always include the 10-digit article number given on the type plate of the machine.

Great Britain

Robert Bosch Ltd. (B.S.C.)
P.O. Box 98
Broadwater Park
North Orbital Road
Denham
Uxbridge
UB 9 5HJ
Tel. Service: +44 (0844) 736 0109
Fax: +44 (0844) 736 0146
E-Mail: boschservicecentre@bosch.com

Ireland

Origo Ltd.
Unit 23 Magna Drive
Magna Business Park
City West
Dublin 24
Tel. Service: +353 (01) 4 66 67 00
Fax: +353 (01) 4 66 68 88

Australia, New Zealand and Pacific Islands

Robert Bosch Australia Pty. Ltd.
Power Tools
Locked Bag 66
Clayton South VIC 3169
Customer Contact Center
Inside Australia:
Phone: +61 (01300) 307 044
Fax: +61 (01300) 307 045
Inside New Zealand:
Phone: +64 (0800) 543 353
Fax: +64 (0800) 428 570
Outside AU and NZ:
Phone: +61 (03) 9541 5555
www.bosch.com.au

Republic of South Africa

Customer service
Hotline: +27 (011) 6 51 96 00

Gauteng – BSC Service Centre

35 Roper Street, New Centre
Johannesburg
Tel.: +27 (011) 4 93 93 75
Fax: +27 (011) 4 93 01 26
E-Mail: bsctools@icon.co.za

KZN – BSC Service Centre

Unit E, Almar Centre
143 Crompton Street
Pinetown
Tel.: +27 (031) 7 01 21 20
Fax: +27 (031) 7 01 24 46
E-Mail: bsc.dur@za.bosch.com

Western Cape – BSC Service Centre

Democracy Way, Prosperity Park
Milnerton
Tel.: +27 (021) 5 51 25 77
Fax: +27 (021) 5 51 32 23
E-Mail: bsc@zsd.co.za

Bosch Headquarters

Midrand, Gauteng
Tel.: +27 (011) 6 51 96 00
Fax: +27 (011) 6 51 98 80
E-Mail: rbsa-hq.pts@za.bosch.com

Disposal

Do not dispose of power tools into household waste!

Only for EC countries:



According to the European Guideline 2002/96/EC for Waste Electrical and Electronic Equipment and its implementation into national right, power tools that are no longer usable must be collected separately and disposed of in an environmentally correct manner.

Subject to change without notice.

1

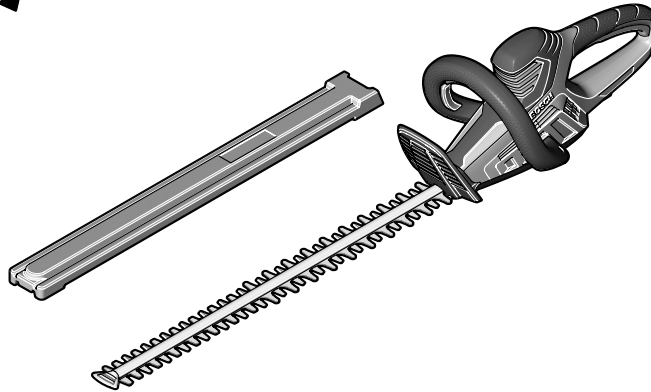
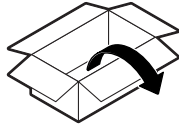

AHS 70-34

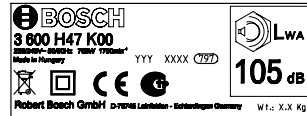

2

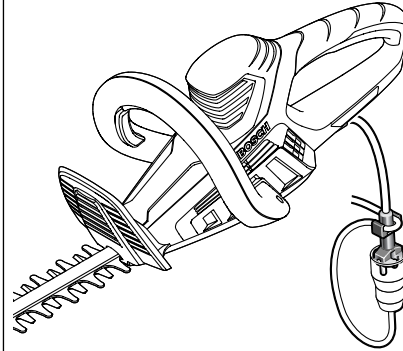
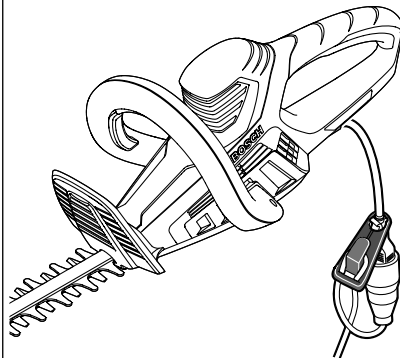

3

① + ② = I

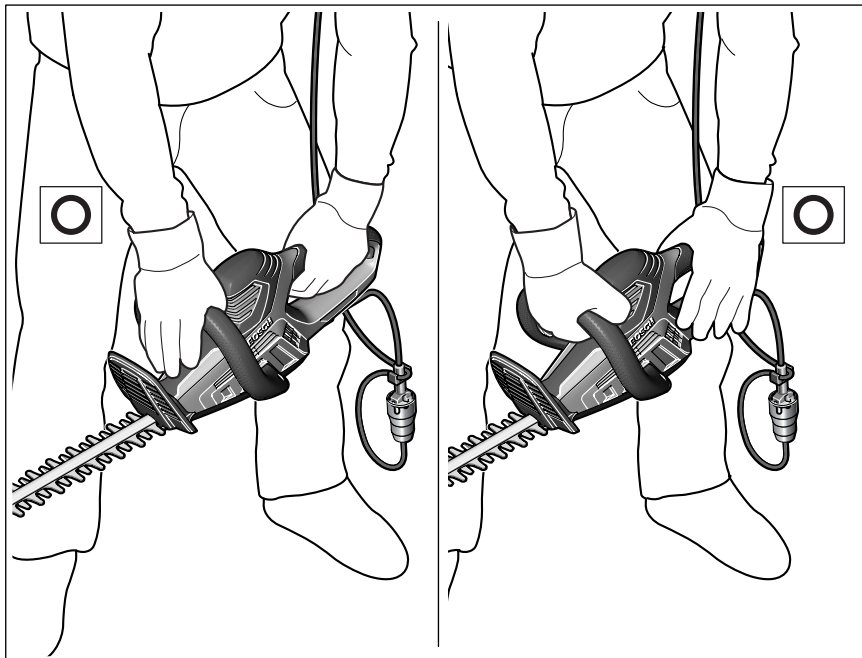
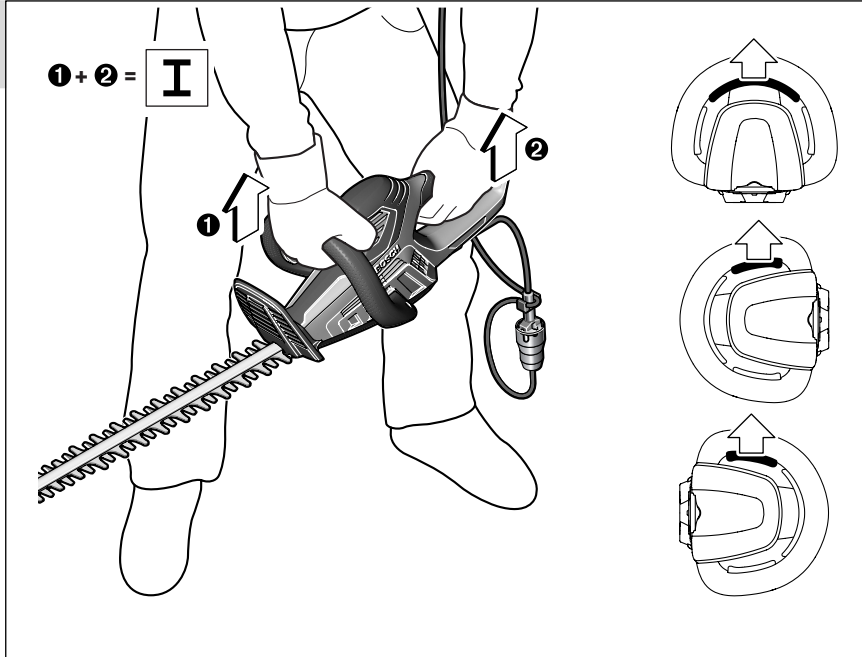

4

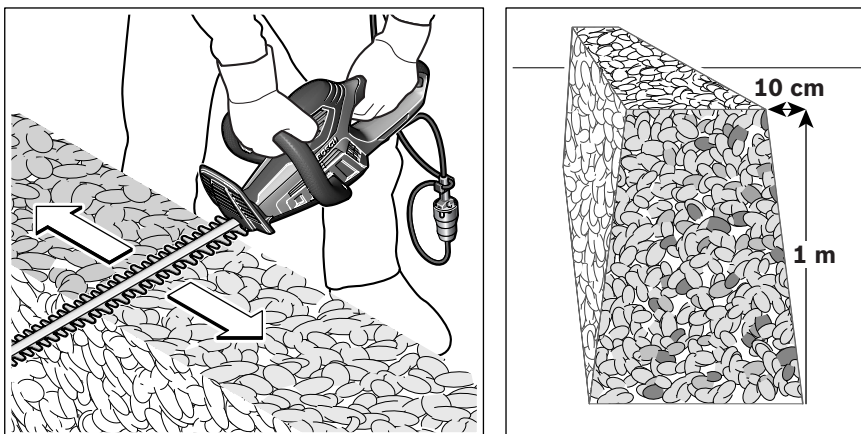
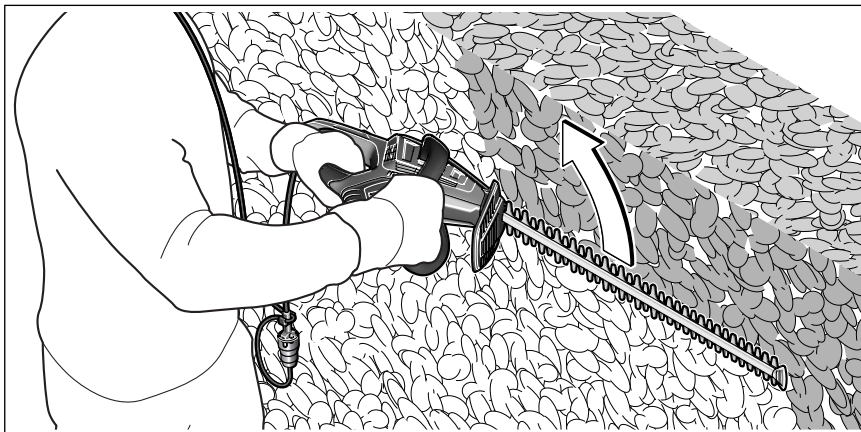
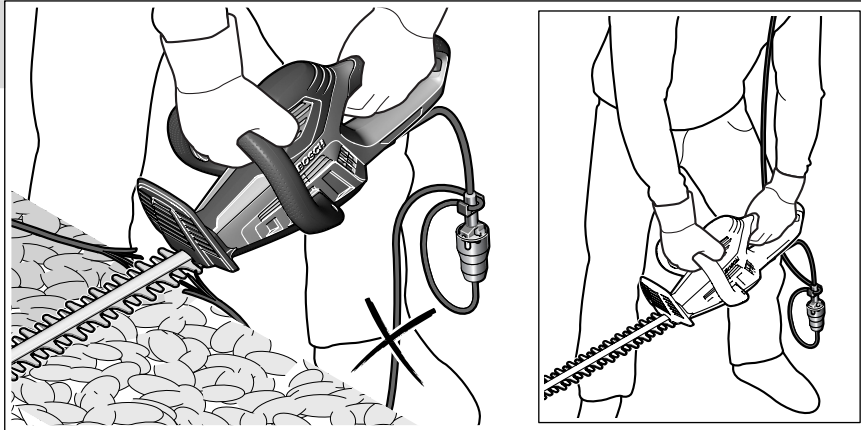



5

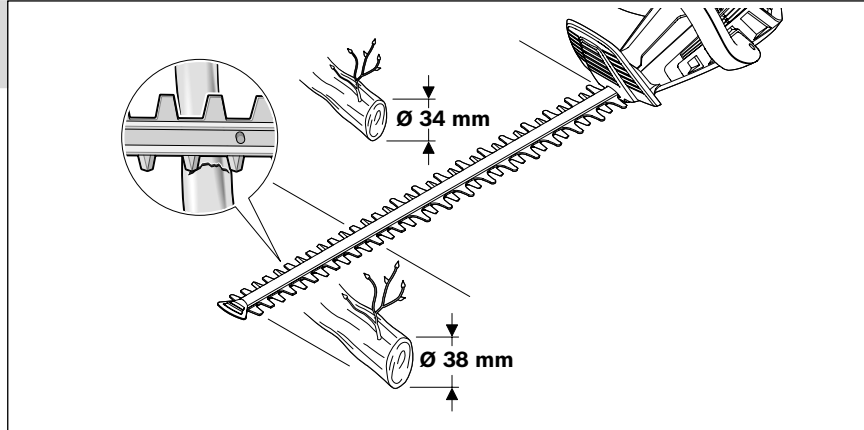

6

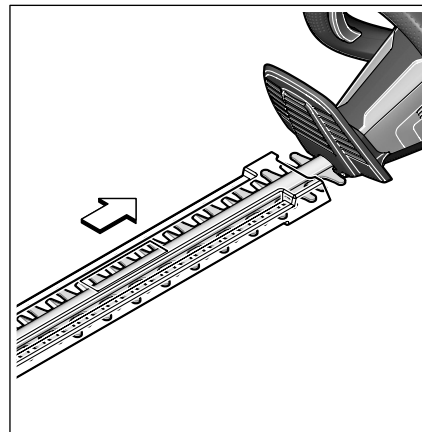
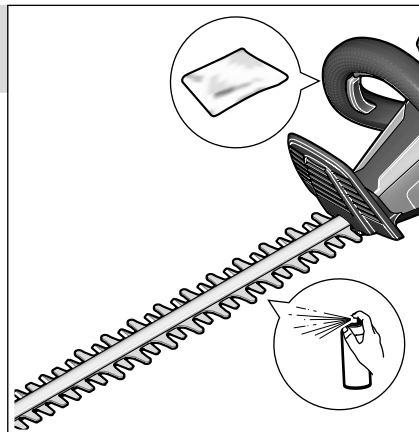

7



1 609 200 399



F 016 800 178

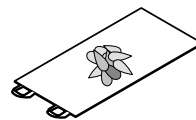

F 016 800 055

