

EC DECLARATION OF CONFORMITY

The manufacturer of the product covered by this Declaration is.



NAP Brands Ltd.
Napier House, Unit 7, Corunna Court,
Warwick, United Kingdom CV34 5HQ

The manufacturer hereby declares that the machine as detailed in this declaration fulfils all the relevant provisions of the Machinery Directive and other appropriate directives as detailed below.

The manufacture further declares that the machine as detailed in this declaration, where applicable, fulfils the relevant provisions of the essential health and safety requirements.

The Directives covered by this Declaration are as detailed below

2006/42/EC The Machinery Directive.
2006/95/EC. Low Voltage Equipment Directive.
2004/108/EC. Electromagnetic Compatibility Directive,
93/68/EC. The CE Marking Directive.
2002/96/EC as amended by 2003/108/EC The Waste Electrical and Electronic Equipment (WEEE) Directive.
2002/88/EC. The Emission of Gaseous and Particulate Pollutants from Internal Combustion Engines to be Installed in Non-Road Mobile Machinery Directive
2000/14/EC, Annex VI, and the Directive 2005/88/EC The Noise Emissions in the Environment by Equipment for use Outdoors Regulations 2001 (SI 2001/1701 as amended)

And is in conformity with the applicable requirements of the following documents

EN 12601
EN 55012
EN 61000-6-1
EN ISO 3744

Product Details:

Description: Inverter Generator
Model No: IM2500I
Brand Name: Impax

Name and address of technical documentation holder.

The technical documentation required to demonstrate that the product meets the requirements of directive has been compiled and is available for inspection by the relevant enforcement authorities.

Signed:  Print: Mark Shannon

Quality Director.
NAP Brands Ltd.
Napier House, Unit 7, Corunna Court, Warwick, United Kingdom CV34 5HQ



Date: 11.09.2013

After sales support: Tel: 0844 264 2485 Website: www.impaxpowertools.com



2500W INVERTER GENERATOR

IM2500I



Always Read Instruction Manual
Retain for Future Reference

CERTIFICATE OF GUARANTEE

This product is guaranteed for a period of 1 Year, with effect from the date of purchase and applies only to the original purchaser. This guarantee only applies to defects arising from, defective materials and or faulty workmanship that become evident during the guarantee period only and does not include consumable items. The manufacturer will repair or replace the product at their discretion subject to the following. That the product has been used in accordance with the guidelines as detailed in the product manual and that it has not been subjected to misuse, abuse or used for a purpose for which it was not intended. That it has not been taken apart or tampered with in any way whatsoever or has been serviced by unauthorised persons or has been used for hire purposes. Transit damage is excluded from this guarantee, for such damage the transport company is responsible. Claims made under this guarantee must be made in the first instance, directly to the retailer within the guarantee period. Only under exceptional circumstances should the product be returned to the manufacturer. In this case it shall be the consumer's responsibility to return the product at their cost ensuring that the product is adequately packed to prevent transit damage and must be accompanied with a brief description of the fault and a copy of the receipt or other proof of purchase. The manufacturer shall not be liable for any special, exemplary, direct, indirect, incidental, or consequential loss or damage under this guarantee. This guarantee is in addition to and does not affect any rights, which the consumer may have by virtue of the Sale of Goods Act 1973 as amended 1975 and 1999.

INTRODUCTION

Thankyou for purchasing this product which has passed through our extensive quality assurance process. Every care has been taken to ensure that it reaches you in perfect condition. However, in the unlikely event that you should experience a problem, or if we can offer any assistance or advice please do not hesitate to contact our customer care department. For details of your nearest customer care department please refer to the telephone numbers at the back of this manual.

Safety First

Before attempting to operate this product the following basic safety precautions should always be taken to reduce the risk of fire, electric shock and personal injury. It is important to read the instruction manual to understand the application, limitations and potential hazards associated with this product.

HELPLINE & SPARE PARTS

In the unlikely event of a defect occurring please contact our Helpline.
Office hours: Monday - Friday 9:00am – 5:30pm.
Telephone Number 0844 264 2485

SAFETY INFORMATION

Specific Safety Instructions

Electrical generator must always be grounded, (connected to earth).

Petrol or diesel powered generators must never be used in an unventilated closed spaces. The exhaust fumes are highly dangerous and can cause "Carbon Monoxide Poisoning" which will cause drowsiness and death.

The generator must be mounted on a firm level surface.

The electrical output load must not exceed the maximum load stated on the rating plate.

Exceeding the rated load will damage the unit or shorten its life and will invalidate the guarantee.

The engine must not be run at speeds that exceed the maximum stated on the rating plate.

Operating an engine at excessive speeds increases the hazard of personal injury.

Do not tamper with components, which may increase or decrease the governed speed.

Mains extension leads, mains supply leads, and all electrical equipment must be in good working condition.

Never operate electrical equipment with damaged or defective mains supply leads.

Keep the area around the generator clear of obstructions at all times. Never locate the generator against a building or near a canvas or plastic structure i.e. Tents etc.

Always use the correct fuel mix as stated in the user manual and on the rating plate.

To prevent fire, always stop the engine when refueling and never over fill the fuel tank.

Always clean up spilt fuel immediately using sand.

Do not use the generator in or near an explosive atmosphere.

To prevent an electric shock, never operate the machine in rain, snow or touch with wet hands.

Check the fuel system periodically for leaks, seals and hoses should be checked for signs of deterioration or chafing. Check for loose or missing clamps, damaged fuel tank or filler cap. All defects should be corrected before further use.

Always allow the generator to reach full operating speed before connecting any electrical load.

Always disconnect the electrical load before switching the generator off.

To prevent surging that may possibly damage electrical equipment, do not allow engine to run out of fuel while electrical loads are connected.

Before transporting the generator in a vehicle, drain all fuel to prevent leakage.

To prevent an electric shock and fire, never connect an electrical load with the electrical output switched on.

Do not connect the generator to any other electrical source.

The engine speed has been factory set to provide safe operation. Tampering with the engine speed adjustment could result in overheating of attachments and could cause a fire. Never attempt to "speed-up" the engine to obtain more performance. Both the output voltage and frequency will be thrown out of standard by this practice, endangering attachments and the user.

Store the generator in a well-ventilated area with the fuel tank empty.

Fuel Filling instructions

Warning! Select bare ground for fuelling and move at least 10 feet (3m) from fuelling spot before starting the engine. After refuelling, properly tighten fuel cap; wipe off any spilled fuel and check for leakage.

Warning! If fuel gets spilled on clothes, especially trousers, it is very important to change clothes immediately. Do not rely on evaporation.

Flammable quantities of fuel may remain on clothes after a spill for longer than expected.

SAFETY INFORMATION

Warning! Vibrations can cause an improperly tightened fuel cap to loosen or come off and spill quantities of fuel. In order to reduce the risk of fuel spillage and fire, tighten fuel filler cap by hand as securely as possible.

Before use always make sure that the fuel cap has been properly tightened. Check for fuel leakage while refuelling and during operation. If a fuel leak is suspected, do not start or run the engine until leak is fixed and spilled fuel has been wiped away.

Warning! The ignition system of your unit produces an electromagnetic field of a very low intensity. This field may interfere with some pacemakers. To reduce the risk of serious or fatal injury, people with a pacemaker fitted should consult their physician and the pacemaker manufacturer before operating this tool.

General Safety Rules

Warning! Read all instructions. Failure to follow all instructions listed below may result in electric shock, fire and/or serious injury. The term "power tool" in all of the warnings listed below refers to your mains operated (corded) power tool or battery operated (cordless) power tool.

Save These Instructions

1) Work Area

- a) **Keep work area clean and well lit.** Cluttered and dark areas invite accidents.
- b) **Do not operate power tools in explosive atmospheres, such as in the presence of flammable liquids, gases or dust.** Power tools create sparks which may ignite the dust or fumes.
- c) **Keep children and bystanders away while operating a power tool.** Distractions can cause you to lose control.

2) Electrical Safety

- a) **Power tool plugs must match the outlet. Never modify the plug in any way. Do not use any adapter plugs with earthed (grounded) power tools.** Unmodified plugs and matching outlets will reduce risk of electric shock.

- b) **Avoid body contact with earthed or grounded surfaces such as pipes, radiators, ranges and refrigerators.** There is an increased risk of electric shock if your body is earthed or grounded.
- c) **Do not expose power tools to rain or wet conditions.** Water entering a power tool will increase the risk of electric shock.
- d) **Do not abuse the cord. Never use the cord for carrying, pulling or unplugging the power tool. Keep cord away from heat, oil, sharp edges or moving parts.** Damaged or entangled cords increase the risk of electric shock.
- e) **When operating a power tool outdoors, use an extension cord suitable for outdoor use.** Use of a cord suitable for outdoor use reduces the risk of electric shock.

3) Personal Safety

- a) **Stay alert, watch what you are doing and use common sense when operating a power tool. Do not use a power tool while you are tired or under the influence of drugs, alcohol or medication.** A moment of inattention while operating power tools may result in serious personal injury.
- b) **Use safety equipment. Always wear eye protection.** Safety equipment such as dust mask, non-skid safety shoes, hard hat, or hearing protection used for appropriate conditions will reduce personal injuries.
- c) **Avoid accidental starting. Ensure the switch is in the off position before plugging in.** Carrying power tools with your finger on the switch or plugging in power tools that have the switch on invites accidents.
- d) **Remove any adjusting key or wrench before turning the power tool on.** A wrench or a key left attached to a rotating part of the power tool may result in personal injury.

SAFETY INFORMATION

- e) **Do not overreach. Keep proper footing and balance at all times.** This enables better control of the power tool in unexpected situations.
- f) **Dress properly. Do not wear loose clothing or jewellery. Keep your hair, clothing and gloves away from moving parts.** Loose clothes, jewellery or long hair can be caught in moving parts.
- g) **If devices are provided for the connection of dust extraction and collection facilities, ensure these are connected and properly used.** Use of these devices can reduce dust related hazards.

4) Power Tool Use And Care

- a) **Do not force the power tool. Use the correct power tool for your application.**
The correct power tool will do the job better and safer at the rate for which it was designed.
- b) **Do not use the power tool if the switch does not turn it on and off.** Any power tool that cannot be controlled with the switch is dangerous and must be repaired.
- c) **Disconnect the plug from the power source before making any adjustments, changing accessories, or storing power tools.** Such preventive safety measures reduce the risk of starting the power tool accidentally.
- d) **Store idle power tools out of the reach of children and do not allow persons unfamiliar with the power tool or these instructions to operate the power tool.**
Power tools are dangerous in the hands of untrained users.
- e) **Maintain power tools. Check for misalignment or binding of moving parts, breakage of parts and any other condition that may affect the power tools operation. If damaged, have the power tool repaired before use.** Many accidents are caused by poorly maintained power tools.
- f) **Keep cutting tools sharp and clean.**
Properly maintained cutting tools with sharp

cutting edges are less likely to bind and are easier to control.

- g) **Use the power tool, accessories and tool bits etc., in accordance with these instructions and in the manner intended for the particular type of power tool, taking into account the working conditions and the work to be performed.** Use of the power tool for operations different from intended could result in a hazardous situation.

5) Service

- a) **Have your power tool serviced by a qualified repair person using only identical replacement parts.** This will ensure that the safety of the power tool is maintained.

COMPONENTS

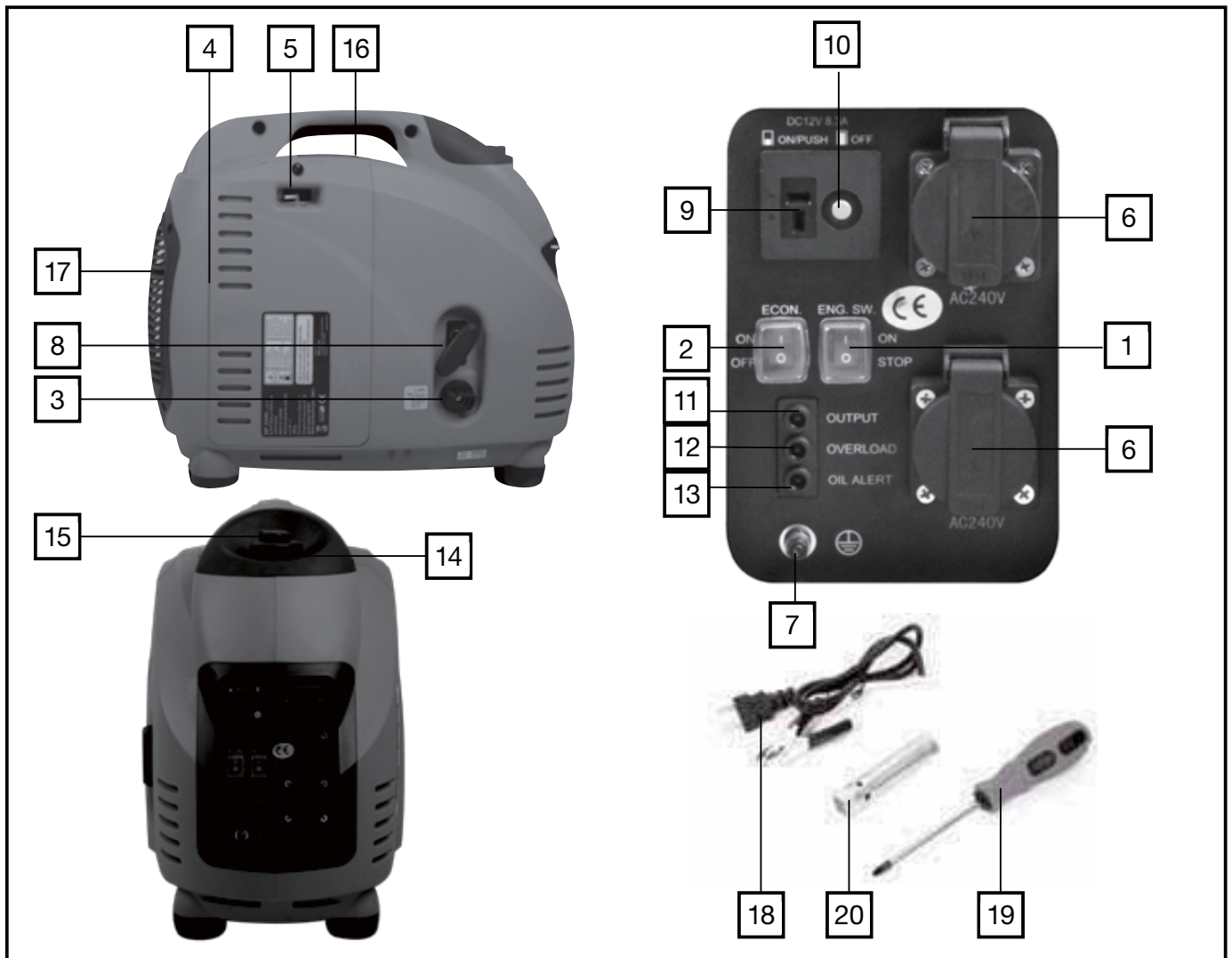

Component List

- | | |
|--|----------------------------------|
| 1. Engine ON/OFF switch | 11. Pilot light (Output) |
| 2. Economy control switch | 12. Overload indicator light |
| 3. Fuel ON/OFF tap | 13. Low Oil warning light |
| 4. Air filter and oil filler maintenance cover | 14. Fuel filler cap |
| 5. Choke lever | 15. Fuel tank vent tap |
| 6. AC socket | 16. Spark plug maintenance cover |
| 7. Ground (earth) terminal | 17. Exhaust |
| 8. Recoil starter | 18. DC charging leads |
| 9. DC socket | 19. Screwdriver |
| 10. DC circuit breaker | 20. Spark plug spanner |

Technical specification

AC output:	230V~50Hz	No load speed (high):	4200 min ⁻¹
Rated power:	2.2kVA	Continuous operating time:	4hrs (100% load)
Peak power:	2.5kVA	Fuel tank capacity:	5.7L
Rated current:	9.6A	Fuel type:	Unleaded petrol
Phase:	Single	Oil type:	SAE 10W-30
Power factor:	cos ϕ =1	Oil capacity:	0.9L
Displacement:	124.6cc	Ignition system:	T.C.I.
DC output:	12V/8.3A	Starting system:	Recoil starter
Engine:	4.6HP, 4 stroke	Spark plug type:	A7RTC
No load speed (low):	3800min ⁻¹	Sound power level:	96dB(A)

UNPACKING AND OPERATING INSTRUCTIONS

Unpacking

Caution! This packaging contains sharp objects. Take care when unpacking. Remove the machine, together with the accessories supplied, from the packaging. Check carefully to ensure that the machine is in good condition and account for all the accessories listed in this manual. Also make sure that all the accessories are complete. If any parts are found to be missing, the machine and its accessories should be returned together in their original packaging to the retailer.

Do not throw the packaging away, keep it safe throughout the guarantee period, then recycle if possible, otherwise dispose of it by the proper means. Do not let children play with empty plastic bags due to the risk of suffocation.

Operating Instructions

Location and Grounding

Before using this generator it must be prepared correctly before use. Locate the generator on firm level ground away from buildings or other structures ensuring that the exhaust is not obstructed.

Warning! It is advisable to properly earth-ground your generator before starting using a wire and a small earth stake. Note: The wire and earth stake are not supplied with the unit.

Earth spike and cable can be purchased at your local camping supplies, or alternatively an earth spike can be made, and it is suggested you get advice from a registered electrical trades person. To make a spike use a copper tube or copper rod 12mm diameter, a minimum length of 200mm and with an M6 machine screw one end. The cable used should be a maximum length of 1 metre and a minimum of 1.0mm² to carry a 10amp load. The cable should be attached to the generator at the earth point (Fig 1) and to the spike between a flat washer and the copper with a lock washer under the head of the M6 Machine screw in a similar fashion to the earth point screw on the generator.

When placing the spike into the ground the generator must not be running and it is suggested that the spike is pushed into the ground by at least 100mm so that it is firm and

a litre of water poured around it to ensure good earth continuity.

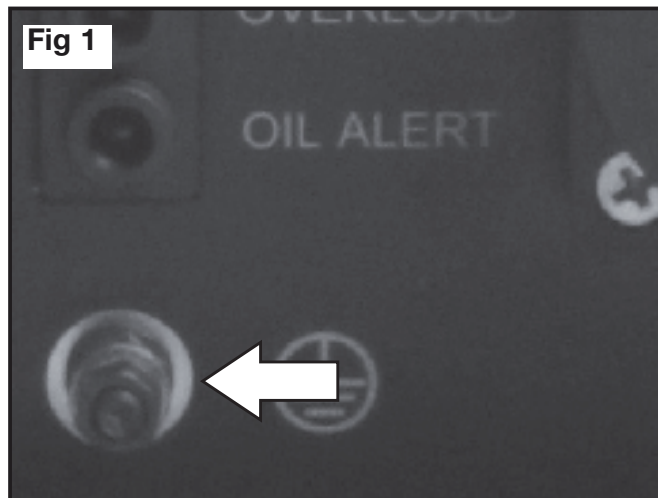

Checking The Oil

Warning! The generator is supplied without oil and must be filled before first use, failure to do so will invalidate your guarantee. Loosen the cover screw and remove the maintenance cover, Fig 2.



Remove the oil filler cap and wipe the dipstick clean, Fig 3.

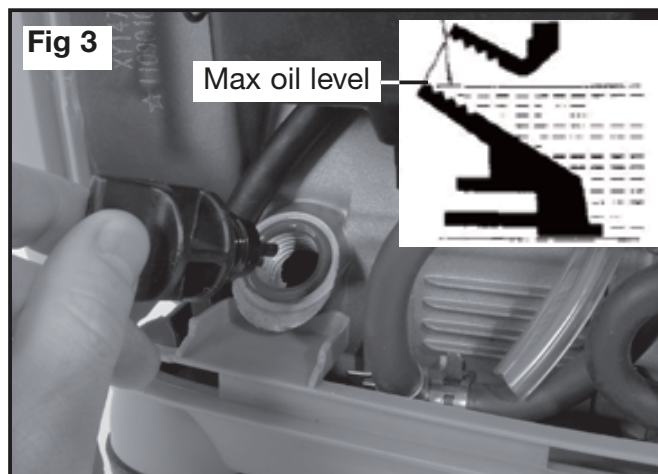

OPERATING INSTRUCTIONS

Check the oil level by inserting the dipstick into the filler neck without screwing it in. If the level is low, fill to the top of the oil filler neck with the recommended oil.

Use high-detergent, premium quality 4-stroke engine oil SAE 10W-30.

Warning! Non-detergent and 2-stroke engine oils will damage the engine and are not recommended.

Low Oil Alert System

The low oil alert system is designed to prevent engine damage caused by an insufficient amount of oil in the crankcase. Before the oil level in the crankcase can fall below a safe limit, the low oil alert indicator light turns on and the low oil alert system will automatically shut down the engine.

Note: The engine switch will remain in the On position. If the engine stops or the oil alert indicator light turns on when you pull the starter grip, check the engine oil level. Oil must be added to the engine before it will re-start.

Fueling

Danger!

STOP engine before adding fuel. This engine is certified to operate on unleaded gasoline. Unleaded gasoline produces fewer engine and spark plug deposits and extends exhaust system life.

Warning! Never use stale or contaminated gasoline or an oil/gasoline mixture. Avoid getting dirt or water in the fuel tank.

Replace and secure the fuel cap after adding fuel, Fig 4.



Petrol is extremely flammable and explosive under certain conditions.

Do not smoke or allow flames or sparks where the generator is refuelled or where Petrol is stored.

Refuel in a well-ventilated area.

Do not let fuel spill over the generator casing. If there is some fuel spillage, be sure that it has evaporated before starting the engine.

Avoid touching gasoline or breathing in gasoline fumes.

Starting the generator

AC Power Applications. Before using this generator it must be prepared correctly before use. Locate the generator on firm level ground away from buildings or other structures ensuring that the exhaust is not obstructed.

Before starting the engine make sure that all the electrical loads are disconnected from the generator AC outlet socket.

Open the fuel filler cap vent (Fig 5) and the fuel cock, Fig 6.

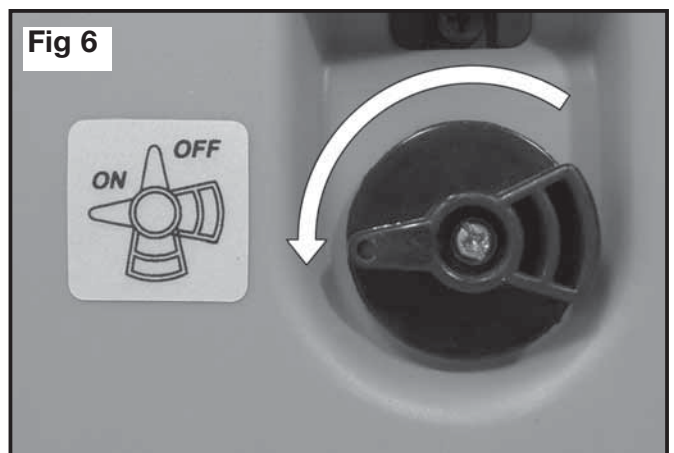
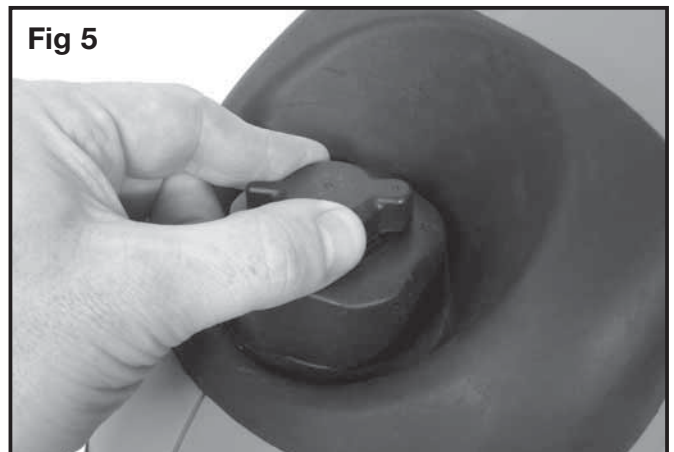

OPERATING INSTRUCTIONS

Turn the engine switch to the On position and the economy switch to the Off position, Fig 7.

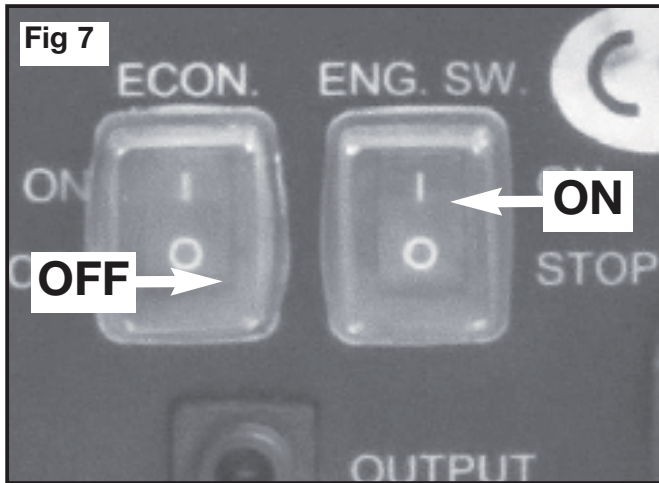

To start a cold engine, set the choke to the "CHOKE" position, Fig 8.

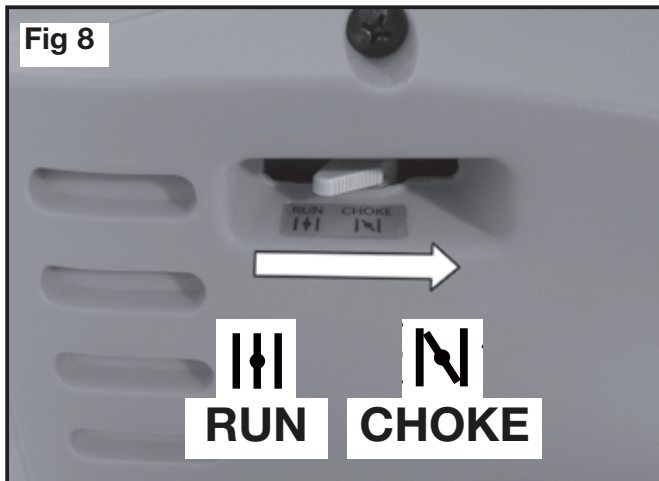

Caution: When engine is hot or environment temperature is high, set the choke to the "Run" position.

Hold down the generator firmly with one hand. With the other hand grip the recoil starter cord handle and pull slowly until resistance is felt indicating that the recoil starter is engaged.

When resistance is felt pull the cord sharply. Continue this procedure until the engine starts, Fig 9.

Caution: Do not allow the starter grip to snap back.

When the engine has been successfully started and is running smoothly return the choke to the "RUN" position.



Warning! Before connecting any electrical load to the generator ensure that the load does not exceed the maximum load as stated on the rating plate. Ensure that the appliance being connected is in good working order and that the mains supply lead is long enough to reach the generator without any strain.

When the generator engine has been successfully started and is running smoothly connect the electrical load into the generator AC output socket.

Warning! DC power and AC power can be used at the same time but DO NOT exceed the maximum power output, as shown on the rating plate.

DC Battery Charging Function

This function is applicable to 12V battery charging only.

Disconnect the leads from the battery.

Loosen the vents on the battery.

Make sure the battery fluid level is correct

Using a hydrometer measure the specific gravity of the battery fluid and calculate the charging time in accordance with the table shown, Fig 10.

Attach the 12v charging leads to the battery observing correct polarity (Red = + Positive) (black = - Negative).

Plug the 12v charger lead into the socket on the generator, Fig 11.

The specific gravity for the fully charged battery shall be within 1.26 to 1.28. It is advisable to check the specific gravity every hour.

OPERATING INSTRUCTIONS

Fig 10

Aim for specific gravity and charging time

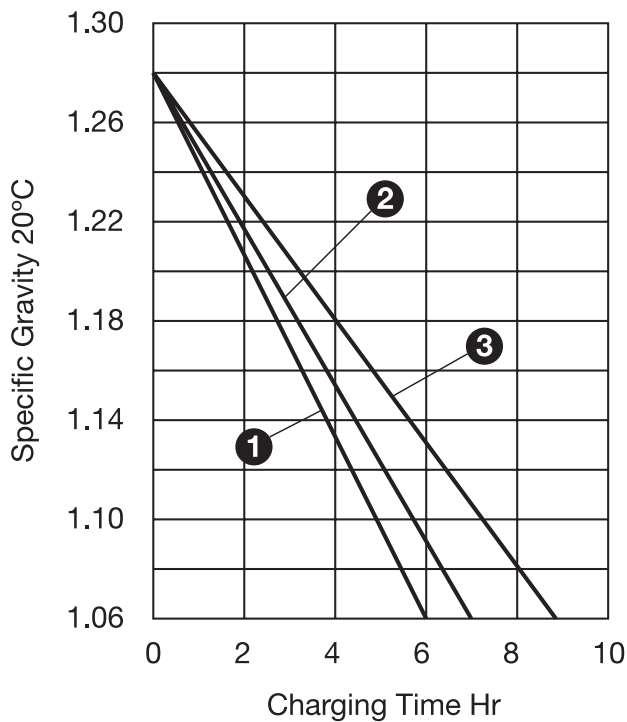

Battery	Battery Capacity
30Ah	20Hr
35Ah	20Hr
47Ah	20Hr

Fig 12



With the switch in the On position, the engine speed is controlled automatically. The engine speed is lowered when the load on the generator is reduced, turned off or disconnected. When loads are turned on or re-connected, the engine returns to the correct speed to power the connected load.

In the Off position the system does not operate. The economy system also helps in fuel economy and reduced noise levels when under no load conditions.

When a load is connected to the generator, the generator speed will automatically adjust in order to supply enough power.

Appliances with large start-up power demands may not allow the engine to reach normal operating speed when they are connected to the generator. Turn the economy switch to the Off position and connect the appliance to the generator. If the engine still will not reach normal operating speed, check that the appliance does not exceed the rated load capacity of the generator.

Stopping The Generator Engine

Before stopping the engine make sure that all the electrical loads are disconnected from the generator AC outlet socket. Turn the generator On/Off switch to the Off position, Fig 13.

Close the fuel filler cap vent, Fig 14.

Fig 11

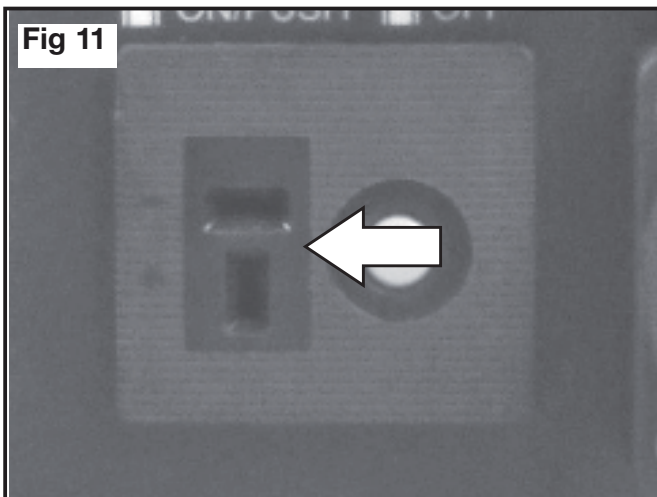

Economy Control Switch (Fig 12)

On: Recommended to minimize fuel consumption and further reduce noise levels when no load is applied to the generator.

Off: The smart throttle system does not operate. Engine speed varies with the load.

OPERATING INSTRUCTIONS

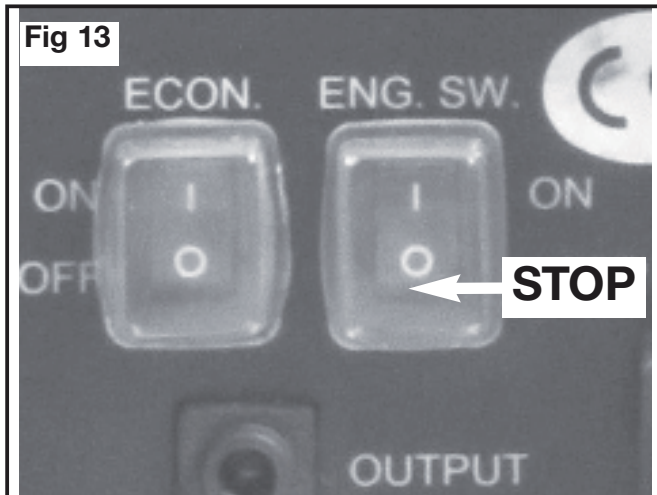

If the (Red) overload indicator light illuminates stop the generator and investigate the cause.

Before connecting an appliance to the generator, check that it is in good order, and that its electrical rating does not exceed that of the generator. Then connect the power cord of the appliance, and start the engine.

When an electric motor is started, both the (Red) overload indicator and the (Green) output indicator will illuminate simultaneously. This is normal, the (Red) over- load indicator extinguishes after about four (4) seconds. If the (Red) overload indicator remains illuminated, consult your generator dealer.



Caution: Substantial overloading that continuously illuminates the (Red) overload indicator may damage the generator. If the (Red) overload indicator light and the (Green) output indicator illuminate at the same time when engine starts and the (Red) overload indicator remains illuminated after the (Green) output indicator extinguishes, please contact your supplier.

Note: For equipment with an inductive load (more power will be required at initial start). Under these conditions it is normal for both the (Red) overload indicator and the (Green) output indicator will illuminate simultaneously for a short period about four (4) seconds. After the appliance starts, the (Red) over-load indicator extinguishes and the (Green) output indicator will remain illuminated.

Overload Protection (Fig 15)

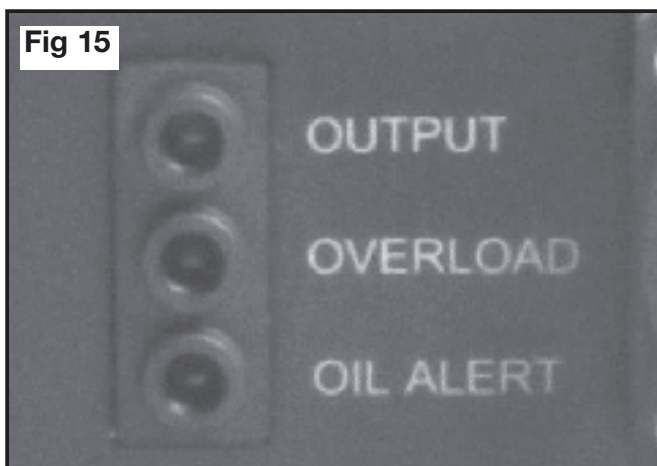

Under normal working conditions the (Green) output indicator light will be illuminated.

If the generator is overloaded or if there is a malfunction or a short circuit in a connected appliance, the (Green) output indicator will extinguish and the (Red) overload indicator light illuminates and the power to the connected appliance will be disconnected.

The circuit breaker for the 12V DC charging function is positioned next to the 12V socket, Fig 16.

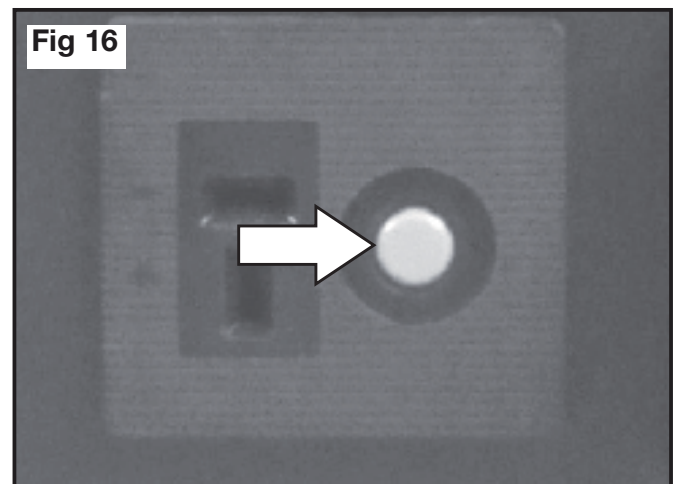

OPERATING INSTRUCTIONS

Spark Plug Maintenance

To ensure proper engine operation, the spark plug must be properly gapped and free of deposits.

Remove the spark plug maintenance cover, Fig 17.

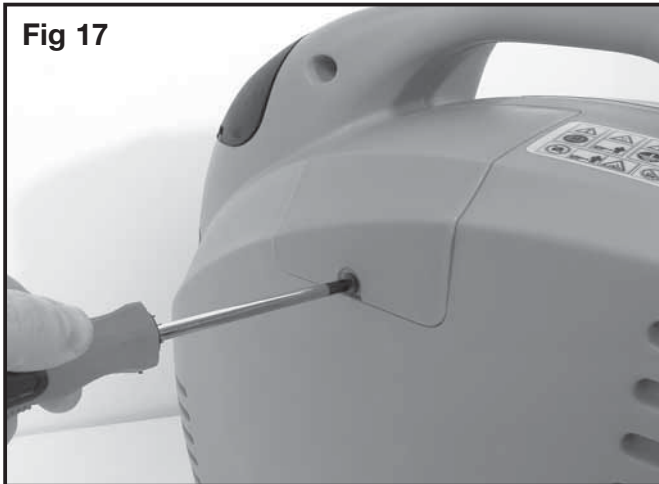

Pull the HT lead off the spark plug, Fig 18, and clean any dirt from around the spark plug base. Using the wrench supplied remove the spark plug, Fig 19.

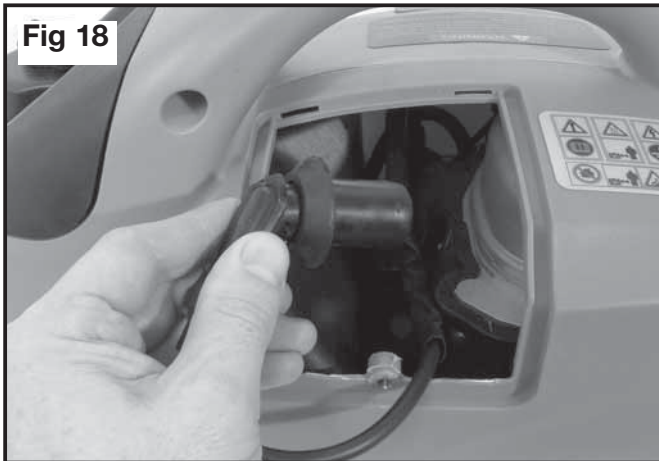

Visually inspect the spark plug. Discard it if the insulator is cracked or chipped. Please use a spark plug gauge to check the spark plug gap, it should be 0.6-0.7mm (0.024-0.028inch).

Check that the spark plug sealing washer is in good condition, and thread the spark plug in by hand to prevent cross threading.

After the spark plug is seated, tighten with a spark plug wrench to compress the washer. If installing a new spark plug, tighten 1/2 turn after the spark plug seats to compress the washer. If reinstalling a used spark plug, tighten 1/8 - 1/4 turn after the spark plug seats to compress the washer.

Reinstall the spark plug cap on the spark plug securely.

Reinstall the spark plug maintenance cover.

Warning! Spark plug must be assembled firmly, or it will become hot and may damage generator.

A loose spark plug can overheat and damage the engine.

Engine Oil Replacement

Remove the side maintenance cover, Fig 20.

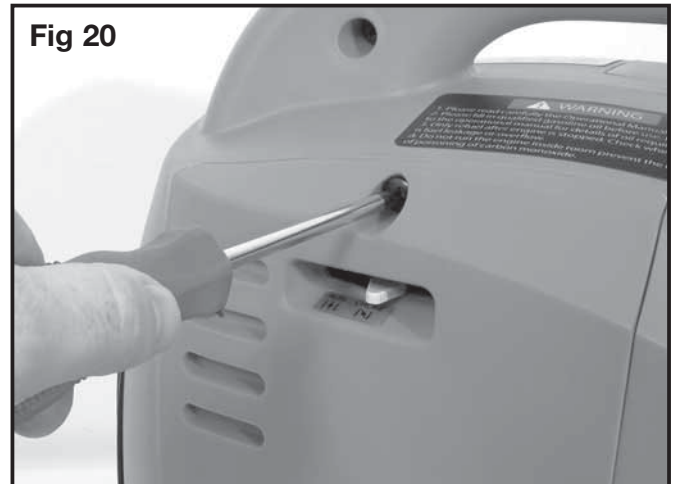

Note: Drain the used oil while the engine is warm. Warm oil drains quickly and completely.

Place a suitable container under the engine to catch the used oil. Remove the dipstick and pour out the old oil into the container, Fig 21.

OPERATING INSTRUCTIONS

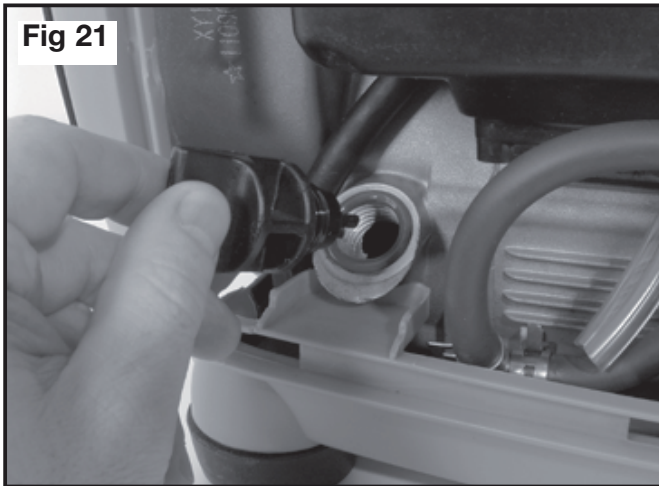

With the engine in a horizontal position, fill to the top of the oil filler neck with the recommended oil.

Replace the dipstick then reinstall the maintenance cover and tighten the cover screw securely.

Note: Improper disposal of engine oil can be harmful to the environment. If you change oil please dispose of it properly. Put it in a sealed container and take it to a recycling centre. Do not discard it in household waste, dump it on the ground or pour it down a drain.

Fuel Tank Filter (Fig 22)

After every 100 hours of running or every 6 months the fuel tank filter should be removed and cleaned.

Remove the fuel tank filler cap and the filter, clean the filter thoroughly using an environmentally friendly water based degreasing agent and re-fit.



Air Filter

A dirty air cleaner will restrict air flow to the carburettor. To prevent carburettor malfunction, service the air cleaner regularly.

Warning! Using gasoline or flammable solvent to clean the air filter can cause a fire or explosion. Use only soapy water or a non flammable solvent.

Having first removed the side maintenance cover, Fig 23, loose the 2 nuts (with M10 socket wrench) and 6 screws on the air cleaner cover, and remove the cover. Fig 24, 24-2. Then release 1 bolt (with M8 socket wrench) 24-3.

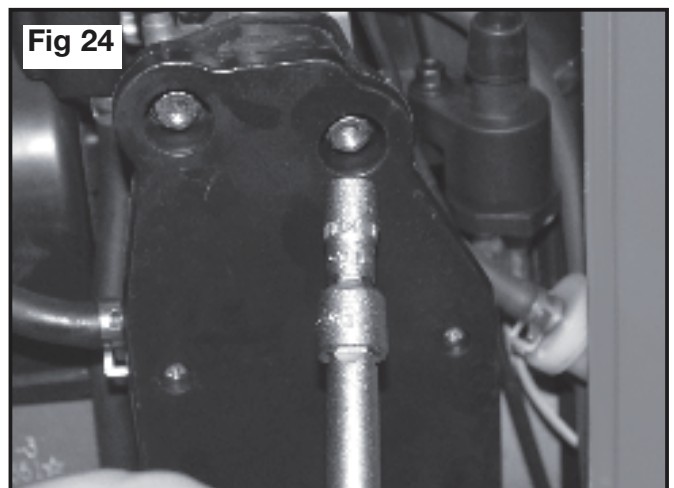

Pull away the air cleaner housing, use the flat screwdriver to release two plastic clips, then the filter can now be removed. Fig. 25 & 26. Wash the air filter in a solution of household detergent and warm water, then rinse it thoroughly, or wash it in a non flammable or high flash point solvent. Allow the air filter to dry thoroughly.

OPERATING INSTRUCTIONS

Reinstall the air filter and cleaner cover, then reinstall the maintenance cover.

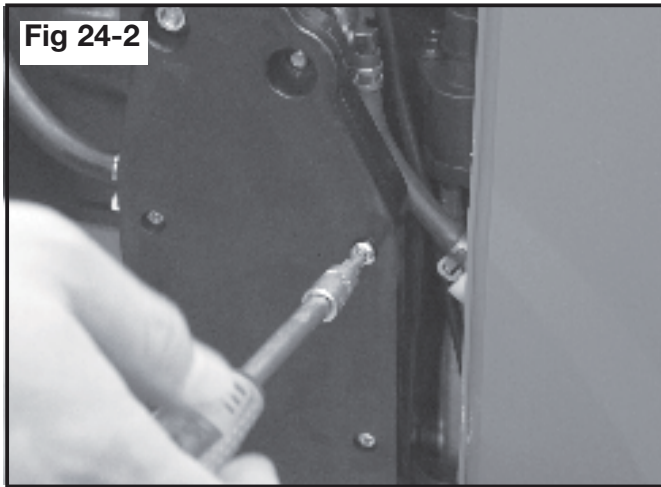

Fig 24-2

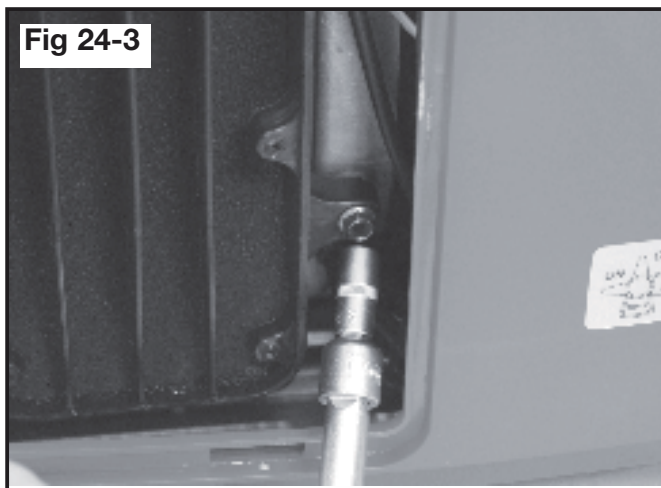

Fig 24-3



Fig 25

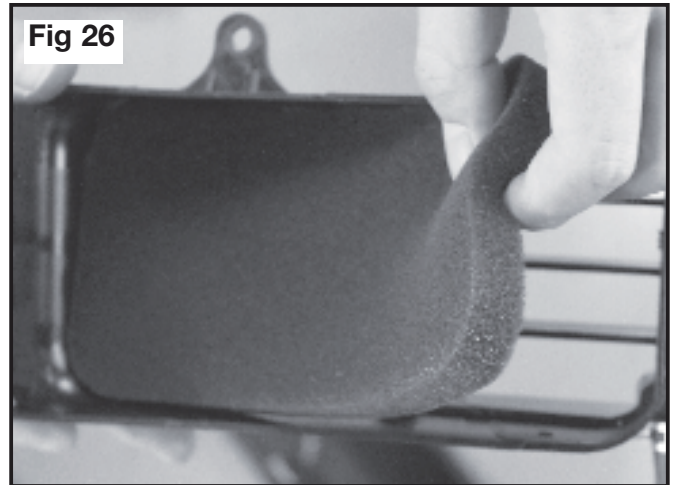

Fig 26

Oil Filter

The oil filter should be cleaned every 6 months or 100 hours of use. The oil filter can be found on the base of the generator. Ensure the generator has been drained of oil, remove the cap, Fig 27, to gain access to the filter assembly.

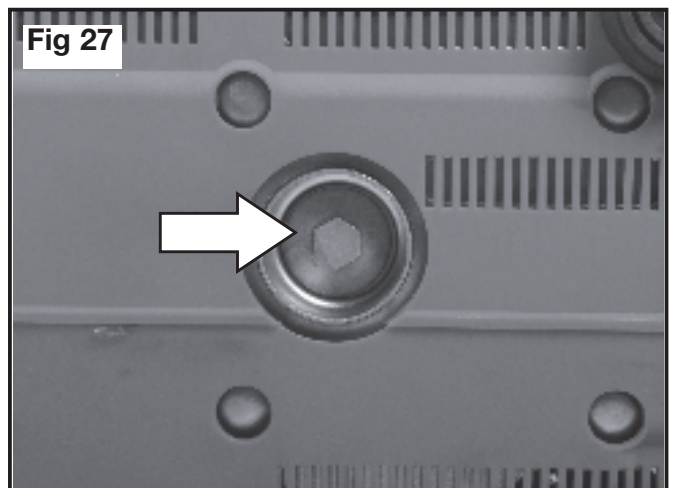

Fig 27

General Inspection And Storage

Regularly check that all the fixing screws are tight. They may vibrate loose over time.

Storage

If the generator is not to be used or is to be stored for more than one month the following storage procedure should be carried out. Drain all the fuel from the fuel tank and the carburettor, ensure that all the fuel has been removed. Remove the spark plug and pour approximately one tablespoon full of clean engine oil into the spark plug hole. With the ignition turned OFF gently pull on the recoil starter cord several times. Re-fit the spark plug

OPERATING INSTRUCTIONS

and continue to pull the recoil starter cord until the piston is on the compression stroke (when resistance is felt) then stop pulling.

Store the generator in a dry well ventilated place under a cover to prevent any dust or debris from accumulating on the generator.

PLEASE NOTE:

If using for a caravan, motor home or boat etc refer to the manufacturers manual regarding connection of a generator.

Do **NOT** connect into a house ring main circuit.

TROUBLESHOOTING

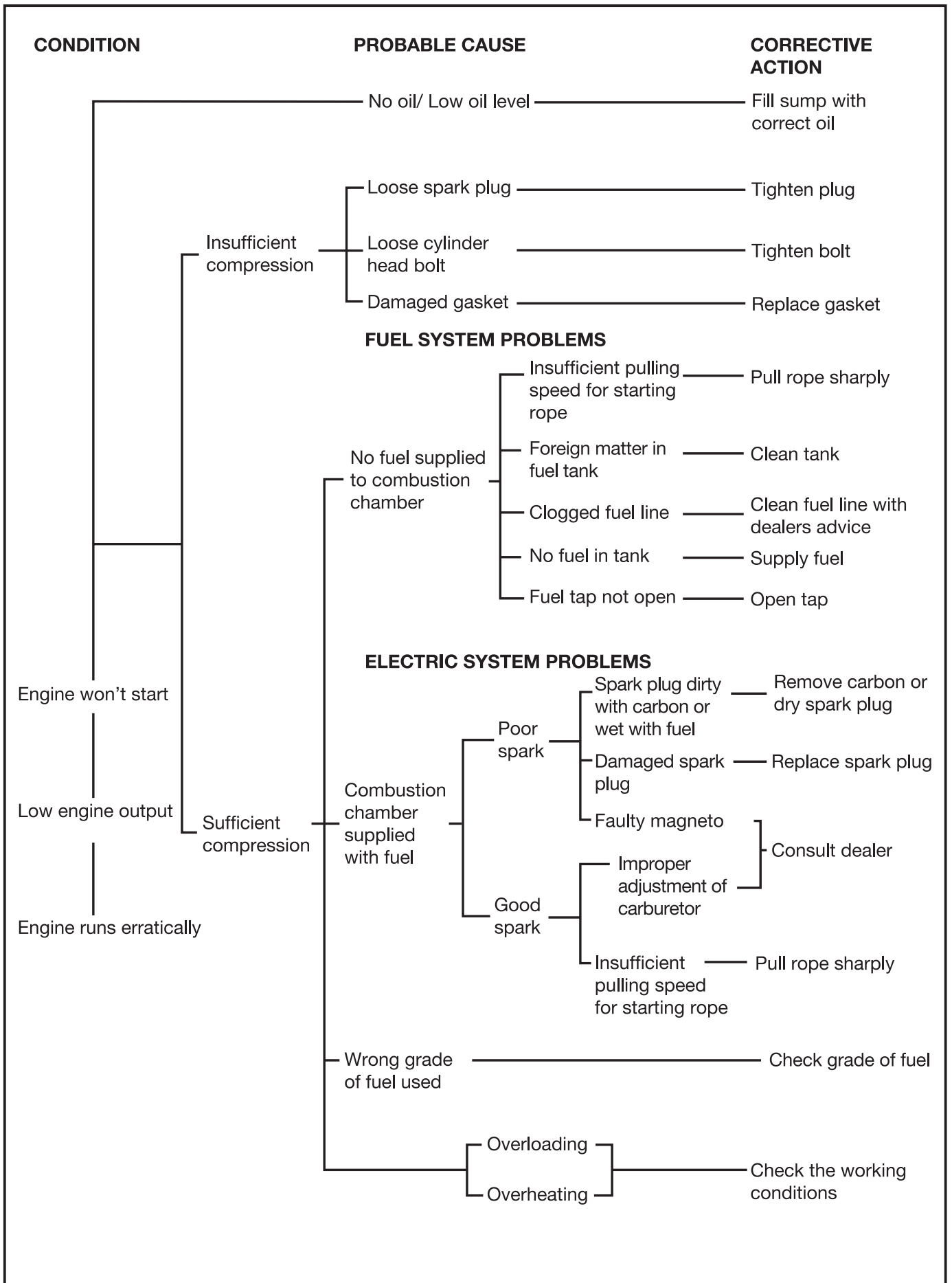

TROUBLESHOOTING

CONDITION	PROBABLE CAUSE	CORRECTIVE ACTION
Indicator light ON. No AC output	Tripped circuit breaker	Reset
	Poor connection or faulty lead	Check and repair
	Broken recepticle	Check and repair
	Faulty circuit breaker	
Indicator light OFF. No AC output	Generator problem	
Output power too high or low	Engine RPM set too high or low	No load speed set to 3000rpm
	Loose component	Locate and tighten
	Internal generator problem	Consult dealer

MAINTENANCE CHART

Item	Remark	Pre-operation check (daily)	Initial 1 month or 20hours	Every 3 month or 50 hours	Every 6 month or 100 hours	Every 12 month or 300 hours
Spark plug	Check condition Adjust gap and clean Replace if required			●		
Engine oil	Check oil level	●				
	Replace		●		●	
Air filter	Clean. replace if required			●		
Fuel Filter	Clean fuel cock filter Replace if required				●	
Valve clearance	Check and adjust when engine is cold					●
Fuel line	Check fuel hose for cracks or damage. Replace if required	●				
Exhaust system	Check for leakage. Tighten or replace gasket if required.	●				
	Check exhaust screen. Clean and replace if required.				●	
Carburetor	Check choke operation	●				
Cooling system	Check fan damage					●
Starting system	Check recoil starter operation	●				
Decarbonisation	More frequently if necessary					●
Fittings/ Fastenings	Check all fittings and fixtures and tighten if required				●	

The figures quoted are emission levels and are not necessarily safe working levels. Whilst there is a correlation between the emission and exposure levels, this cannot be used reliably to determine whether or not the actual level of exposure of the workroom, the other sources of noise etc. i.e. the number of machines and the adjacent processes and the length of time for which an operator is exposed to the noise. Also the permissible exposure level can vary from country. This information however, will enable the user of the machine to make a better evaluation of the hazard and risk. The supplier recommends the use of ear protection at all time.

ENVIRONMENTAL PROTECTION

Information for (private householders) for the environmentally responsible disposal of Waste Electrical and Electronic Equipment (WEEE)



This symbol on products and or accompanying documents indicates that used and end of life electrical and electronic equipment should not be disposed of in household waste. For the proper disposal, treatment, recovery and recycling, please take these products to designated collection points, where they will be accepted on a free of charge basis. Alternatively, in some countries you may be able to return your products to your retailer upon the purchase of an equivalent new product. Disposing of this product correctly will help to save valuable resources and prevent any potential adverse effects on human health and the environment which could otherwise arise from inappropriate waste disposal and handling. Please contact your local authority for further details of your nearest designated collection point. Penalties may be applicable for incorrect disposal of this waste in accordance with national legislation.

FOR BUSINESS USERS IN THE EUROPEAN UNION.

If you wish to discard electrical and electronic equipment, please contact your dealer or supplier for further information.

Information on Disposal in other Countries outside the European Union.

This Symbol is only valid in the European Union.

If you wish to dispose of this product, please contact your local authorities or dealer and ask for the correct method of disposal.

SYMBOLS

The rating plate on this product may show symbols. These represent important information about the product or instructions on its use.



Wear hearing protection.
Wear eye protection.
Wear respiratory protection.



Conforms to relevant safety standards.



Read the instruction manual.



General warning



Waste electrical products should not be disposed of with household waste. Please recycle where facilities exist.



Check with your Local Authority or retailer for recycling advice.



Connect the generator to earth using a suitable earth spike



CAUTION: This is a 4 stroke engine. Fill with petrol and oil mixture only. Do not fill with diesel oil



Allow motor to cool before opening the fuel cap. The vapour is extremely flammable and may ignite on contact with hot surface or flames



CAUTION: Hot exhaust, do not touch