



FOCALPOINT

FULL DEPTH GAS FIRE

MANUAL OR REMOTE CONTROL

RANGE

**BLENHEIM STYLE
ELEGANCE
LULWORTH**

**INSTALLATION AND USER
INSTRUCTIONS**



FOCALPOINT

All instructions must be handed to user for safekeeping

Revision A - 05/04

Country(s) of destination - GB/IE

Focal Point Fires plc, Christchurch, Dorset BH23 2BT

Tel: 01202 499330 Fax: 01202 499326

www.focalpoint.co.uk

e-mail: sales@focalpointfires.co.uk



FOCALPOINT

CE

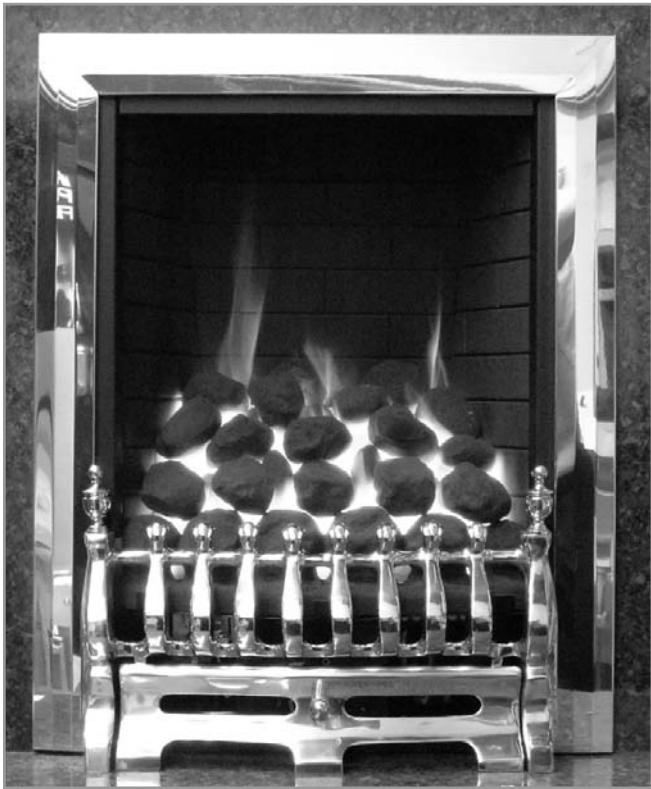

Blenheim Style



Elegance



Lulworth

INSTALLATION INSTRUCTIONS

Preliminary Notes Before Installation

This appliance is an Inset Live Fuel Effect appliance that provides radiant warmth utilising the latest type burner technology.

The fire is designed to fit various types of fireplaces and natural draught flues as listed in the Installation Requirements.

The appliance must be installed by a competent person in accordance with Gas Safety (Installation and Use) Regulations 1998. It is strongly recommended that a CORGI registered engineer be used for this purpose.

Read all these instructions before commencing installation.

This appliance must be installed in accordance with the rules in force and only used in a sufficiently ventilated space.

The appliance is designed for installation on to a non-combustible hearth of at least 300mm depth.

This appliance is factory set for operation on the gas type, and at the pressure stated on the appliance data plate.

This appliance is available in either a manual control version, or a battery powered remote control version, with a number of fuel effect options. These instructions cover both control options, and all fuel effect options. See the relevant sections of these instructions for further details.

<i>Section</i>	<i>Contents</i>	<i>Page No.</i>	<i>Section</i>	<i>Contents</i>	<i>Page No.</i>
1.0	Important Notes	1	11.0	Fitting the Firebox	7
2.0	Appliance Data	2	11.1	Installation by Cable Fixing Kit	7
3.0	Installation Requirements	2	12.0	Fuel Bed Layout (coal versions)	8
4.0	Site Requirements	3	12.1	Fuel Bed Layout (pebble versions)	9
4.1	Debris Collection Space	4	13.0	Fitting the Firefront	10
5.0	Ventilation	4	14.0	Testing and Commissioning	10
6.0	Pre Fabricated Flue Boxes	4	14.1	Operating the Appliance (manual)	10
7.0	Unpacking the Appliance	4	14.2	Operating the Appliance (remote)	11
7.1	Component Checklist	5	14.3	Operating the Handset	11
8.0	Preparing the Appliance	5	14.4	Spark Failure	11
8.1	Fitting the Decorative Frame	6	14.5	Setting Pressure	11
9.0	Preparing the Opening	6	14.6	Flue Spillage Monitoring System	11
10.0	Gas Supply Routing	6	14.7	Testing for Spillage	12
			15.0	Servicing	12
			16.0	Troubleshooting Guide	14

1.0 IMPORTANT NOTES

This fire is an Inset Live Fuel Effect Gas Fire providing radiant warmth. It is designed to operate on Natural Gas only.

It is the LAW that all gas appliances and fittings are installed by a competent person (such as a CORGI registered fitter) and in accordance with the Gas Safety (Installation and Use) Regulations 1998, the relevant British Standards for Installation, Codes of Practice and in accordance with the Manufacturers' Instructions. The installation shall also be carried out in accordance with the following regulations:

The Building Regulations issued by the Department of the Environment, the Building Standards (Scotland) (Consolidation) Regulations issued by the Scottish Development Department.

BS 5871 part 2

BS 5440 part 1

BS 1251

BS 6891

BS 6461 part 1

Note - For Republic of Ireland, reference should be made to the relevant standards governing installation, particularly in regard to flue sizing and ventilation. See IS813, ICP3, IS327 and any other rules in force.

Failure to comply with these regulations could lead to prosecution and deem the warranty invalid.

This appliance must be installed in accordance with the rules in force and used only in a sufficiently ventilated space.

Consult all instructions before installation and use of this appliance.

This appliance is free from any asbestos material. Refractories and coal bed are constructed from ceramic fibre.

Note : Remote control models only - This appliance features a battery-operated remote control system, and under normal usage will need new batteries approximately every twelve months.

Remote control Handset requirements - 1 x 'PP3' type (9 volt)

Receiver/motor unit requirements - 4 x 'AA' type (1.5 volt)

Refer to the appropriate section of these instructions for details of how to change the batteries.

2.0

APPLIANCE DATA

	<u>Manual Control Version</u>	<u>Remote Control Version</u>
Gas Group	G20 Natural Gas CAT I2H	G20 Natural Gas CAT I2H
Inlet Pressure	20 mbar	20 mbar
Max Energy Input (gross)	6.8 kW	6.8 kW
Min Energy Input (gross)	3.5 kW	3.5 kW
Pilot Energy Input (gross)	210 W	210 W
Setting Pressure (cold)	15.8 mbar (+/- 0.75mbar)	15.8 mbar (+/- 0.75mbar)
Main Injector Burner	Stereo size 81/Bray cat. 82/420	Stereo size 81/Bray cat. 82/420
Gas Inlet Connection	8mm Inlet Restrictor Elbow	8mm Inlet Restrictor Elbow
Gas Control Valve	Dungs BM 733/NGC 6801	Mertik Maxitrol GV34 Series
Ignition	Integral Piezo spark	Integral Piezo spark
Spark Gap	3.5 to 4.5mm	3.5 to 4.5mm
Weight	20 Kg	21 Kg

Please see Data Badge affixed to appliance for current data.

This appliance is for use only with the gas type, and at the pressure stated on the appliance Data Badge, and is for decorative purposes.

3.0 INSTALLATION REQUIREMENTS

This appliance MUST NOT be installed into a room containing a bath or shower, or where steam may be present. The fire has been designed to fit into a builders' opening or fireplace conforming to BS 1251 (and meeting certain dimensional requirements), or a suitable flue box complying with the constructional requirements of BS 715. The flue box must be installed onto a suitable non-combustible insulating surface at least 12mm thick, covering the entire base area of the box.

The flue must have an effective height of at least three metres, as measured from the hearth to the top of the flue. Any flue damper plates or restrictors should be removed and no other restriction fitted to the flue. Where removal is not practical, the restriction must be fixed in the fully open position.

A natural draught flue system is required, and if previously used for solid fuel or oil burning, the flue and chimney must be swept prior to appliance installation. Pre-cast flues must be checked for mortar fangs and correct installation of joints, flue sections in loft space and terminals. The flue must be checked before installation by using a smoke pellet or similar to ensure proper draw and that leakage is not evident at any joints. Repair and re-test as necessary before the appliance is installed.

The flue must be connected to only one fireplace, and the flue must not vent more than one appliance (i.e. not shared with a gas back boiler). There must be no opening in the flue apart from the one that the appliance is installed into, and the one venting the gases into the air. A suitable terminal may be fitted, such as class GC1, as regulations allow.

This appliance has been tested for use in a pre-cast block flue complying with BS 1289. In accordance with BS 1289 part 1, pre-cast flues built with directly plastered faces (front or rear) are not correctly installed as to ensure proper operation with **any** type of gas fire. In some instances of this flue construction, temperature cracking of the surface plaster may occur through no fault of the appliance. An air gap or some form of insulation material should be installed to prevent normal flue temperatures from damaging wall surfaces.

This appliance is suitable for use with a "lightweight" surround and back panel of 150°C minimum rating.

4.0 SITE REQUIREMENTS

The fireplace opening should be inspected and repairs made where necessary. Any chair brick or fireback may be left in situ, providing that the dimensional requirements for debris collection space and spigot clearances are met. See diagram below..

The opening WIDTH and HEIGHT dimensions should be between 375mm and 450mm wide, and 540mm (**see note below**) to 575mm high.

Note: The spigot outlet of the fire is 560mm high, but should fit into the gather at the top of the fireplace as the appliance is fitted. Any modifications to the fireplace opening must be to a height of 560mm min.

Opening DEPTH should be 200mm or greater for a clay/cement lined or pre-cast flue which is new, unused, or previously used only with a gas appliance. DEPTH should be 240mm or greater for a flue used for solid fuel or oil burning appliances. Opening DEPTHS include any plaster or infill panels which form part of the installation.

This appliance requires a natural draught flue system which may be one of the following;

225mm x 225mm (9in x 9in) brick or stone.

125mm (5in) minimum diameter lined brick or stone.

125mm (5in) minimum diameter twin wall flue conforming to BS 715.

Pre-cast block flue complying with BS 1289.

Any existing under grate draught device must be sealed off. The opening wall must be non-combustible.

The appliance requires a hearth with non-combustible surface of at least 12mm thick. The top surface must be at least 50mm above the surrounding floor level, or be surrounded by a raised edge or fender 50mm high.

To enable the products of combustion to be cleared properly up the flue, the outlet at the back of the appliance must have a 50mm minimum clearance between it and the back wall of the opening or any other obstruction. The area immediately above the outlet must form a smooth path into the flue.

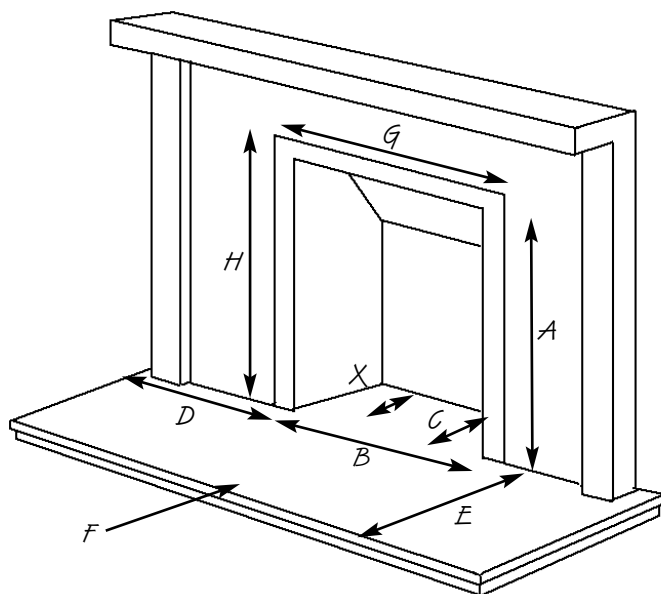

- A. Opening height: 540mm min/575 mm max.
- B. Opening width: 375mm min/450mm max.
- C. Mounting depth: 180mm
- D. Hearth must extend minimum of 150mm either side of the opening.
- E. Hearth must extend minimum of 300mm in front of the opening.
- F. Non-combustible hearth must be a minimum of 50mm in height, or be surrounded by 50mm high fender.
- G. 470mm, this area must be flat and vertical to ensure a good seal.
- H. 585mm, this area must be flat and vertical to ensure a good seal.
- X. Debris collection space - See section 4.1 on following page.

Any type of fire surround used with this appliance must be adequately sealed to the wall and floor.

A combustible shelf may be fixed to the wall above the fire, providing that it complies with the dimensions given below.

<i>Maximum depth of shelf</i>	<i>Minimum distance from finished hearth surface to underside of shelf</i>
100mm (4in)	745mm (29 1/4 in)
150mm (6in)	845mm (33 1/4 in)
203mm (8in)	895mm (35 1/4 in)

A non-combustible shelf may be fitted to within 10mm of the top edge of the fireframe. Combustible materials, such as wood, may be fitted to within 100mm (4in) of either side of the fireplace opening, providing the forward projection does not exceed 100mm (4in).

Any combustible side walls must be at least 500mm to the side of the radiant heat source.

As with all heating appliances, any decorations, soft furnishings, and wall coverings (i.e. flock, blown vinyl and embossed paper) positioned too close to the appliance may discolour or scorch.

4.1 DEBRIS COLLECTION SPACE

The mounting depth of this appliance is 180mm.

In accordance with BS 5871 part 2, minimum debris collection volumes are required behind the installed appliance. These are shown in the table below and as dimension X on the fireplace diagram shown previously.

CLAY/CEMENT LINES OR BLOCK FLUE WHICH IS NEW, UNUSED, OR PREVIOUSLY ONLY USED WITH A GAS FIRE.
X Dimension = 20mm

UNLINED FLUE OR CHIMNEY WHICH HAS BEEN PREVIOUSLY USED FOR A SOLID FUEL OR OIL BURNING APPLIANCE
X Dimension = 60mm

5.0 VENTILATION

No purpose provided ventilation is normally required for this appliance. The requirements of other appliances operating in the same room or space must be taken into consideration when assessing ventilation.

If spillage is detected when commissioning the appliance, then amongst other problems there may be insufficient natural ventilation for correct operation of the flue. If the appliance does not spill with the windows open, but spillage is detected with the windows closed, this demonstrates a lack of natural ventilation. If spillage is still detected with the windows open, the flue is at fault. Installation of an air brick is the best solution to lack of ventilation. Any ventilation fitted must comply with BS 5871 part 2 and BS 5440 part 2. Vents fitted under or within the immediate vicinity of the appliance must not be used as adverse effects to the operation of the ODS may occur.

Spillage detected during commissioning is almost always a result of poor flue performance that cannot be corrected by any amount of ventilation.

For Republic of Ireland ventilation may be required, see IS 813, ICP3, IS 327, and any other rules in force.

6.0 PREFABRICATED FLUE BOXES

This appliance can be fitted into a number of proprietary flue boxes provided that the minimum dimensions given in the diagram below are complied with.

Constructional Note: The frame of the fire, any back panel or other infill panels, and the flue box must be sealed together so that there is no possibility of leakage between them. Adequate clearances to combustible materials (e.g. false chimney breast construction) must be maintained.

The manufacturers' instructions for fitting the prefabricated box shall be complied with at all times.

To fit the fire using the cable fixing kit, some minor adaptation may be necessary for certain flue boxes. A check should be made to ensure the firebox does not obscure the flue box outlet.

The firebox, base of the flue box, and hearth below may be drilled to allow plugs and screws to secure installation.

It is important that the sealing requirements of the appliance are met at all times and that the flue box is well sealed to any back or infill panel.

Note: The DEPTH dimension is inclusive of any back or infill panel.

125mm min internal dia
twin wall flue

560mm min
opening height

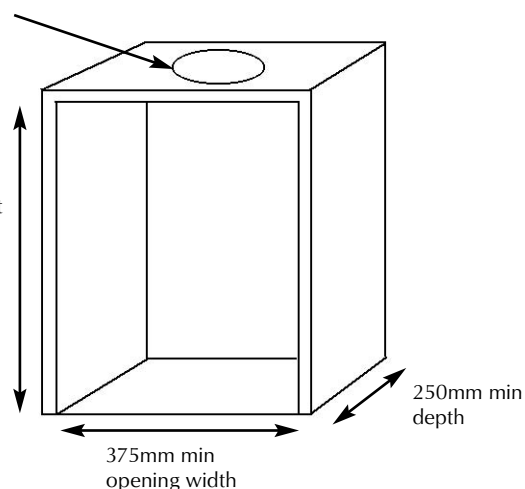

7.0 UNPACKING THE APPLIANCE

Stand the carton the right way up, cut the strapping bands and remove the top endcap. Read **all** the instructions before continuing to unpack or install this appliance.

Remove the box containing the firefront, and the bags containing the ceramic components. Remove the cardboard packing pieces, and any other bags or boxes containing fittings or other parts. When all loose parts have been removed, the outer sleeve may be lifted off to reveal the appliance. Check that the components supplied correlate with the component checklist given in section 7.1. Please dispose of all the packing materials at your local recycling centre.

7.1 COMPONENT CHECKLIST

QUANTITY	DESCRIPTION
1	Firebox and burner tray assembly
1	Decorative frame (either magnetic type or 3 piece clip-on type)
1	Cast or fabricated firefront with separate ashpan door
1	Moulded ceramic fibre combustion matrix
1	Moulded ceramic front strip
16	Individual ceramic coals (coal effect versions)
16	Individual ceramic pebbles (pebble effect versions)
3	Ceramic brick effect radiant panels
2	Ceramic brick panel retaining clips
1	Cable fixing kit; 2 cables, 2 tensioners, 2 cable clamps, 4 eyebolts
1	Sealing grommet
1	Remote control handset (remote control versions only)
1	Set of batteries (1 x 'PP3', 4 x 'AA') (remote control versions only)
3	Lengths of adhesive sealing strip
1	Self tapping screw pack; 4 No8 x 5/16
1	Set of manufacturers instructions
4	Fibre Rawl Plugs

8.0 PREPARING THE APPLIANCE

Note: Ensure that the gas supply is isolated before commencing installation of the appliance.

The fireplace opening and environment must be in compliance with specifications laid down in the appropriate sections of these instructions.

Remove the appliance from its carton as described previously and stand upon a dust sheet or similar. Place the decorative frame, coals, ceramics and fixings safely to one side. Remove the burner from the assembly by removing the retaining screws. The tray is now free, and may be lifted away.

RADIANT PANELS: The three radiant panels may now be fixed inside the firebox. Select the plain or patterned side of each panel and insert as follows; Lay the firebox on its back. Lay the tapered panel onto the rear face of the firebox.

The side panels should be fitted by inserting their front edges into the pre-fitted retaining brackets on the front face of the firebox. Gently align the side panels with the side of the firebox as shown, over the top of the back panels already in place.

Make sure that the side panels are pushed **up** firmly to the roof of the firebox, and **back** firmly to retain the tapered panel. Make small adjustments to line up the mortar lines if required. Secure the side panels using the small 'L' shaped brackets and screws provided (shown inset). The screws should locate into the pre-punched holes in the sides of the firebox.

SPIGOT RESTRICTOR: If installing the fire into a Class 1 or good Class 2 flue, simply bend up (stitch bend join) the spigot restrictor into position in the flue outlet of the fire. **You MUST remove (or bend down fully) the spigot restrictor and re-test if the appliance fails a spillage test during commissioning.**

SUPPLY PIPE ENTRY: Knockout holes are provided in the rear and sides of the firebox for use where concealed pipework is required. Where necessary, knock out the appropriate hole with a sharp tap from a hammer, and fit the rubber grommet supplied. A small incision can now be made in the rubber to slip snugly around the outside of the pipe and sleeving.

Do not install or use the appliance without the seals in place. If a hole is inadvertently opened, reseal with an intact grommet. Failure to fit the seal correctly will cause flue suction to act upon the area under the burner, resulting in poor performance and intermittent cutting out of the burner.

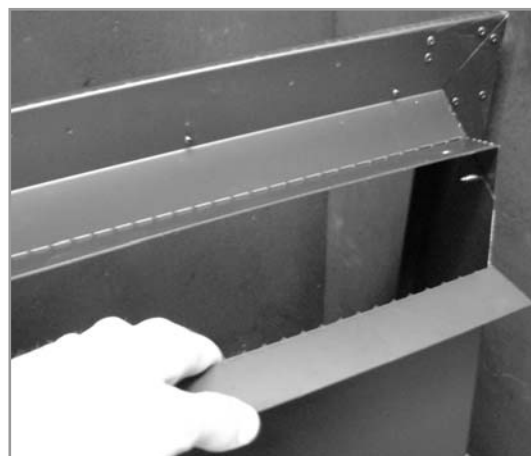
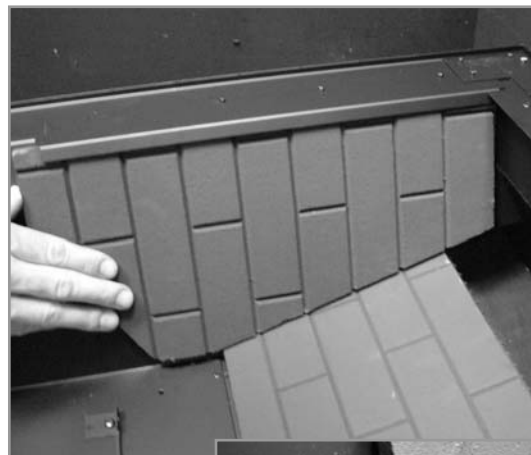

8.1 FITTING THE DECORATIVE FRAME

The appliance is supplied with a decorative frame. The frame attaches to the firebox using either four magnetic pieces, or as a three piece clip-on assembly. If a three piece clip on frame is to be fitted, and the firebox is to be retained by the cable method, this is the most convenient stage at which to do so. Magnetic type frames may either be fitted now or after the appliance has been secured into the opening. If the firebox is to be retained by the screw fixing method, then the frame must be fitted after the appliance is fixed into its final position.

Before fitting the frame remove any plastic protective coating.

For three piece frames : The side pieces of the clip on assembly should be pushed into position first, followed by the top bar (shown), which should overlap the sides. **IMPORTANT NOTE: Due to the possibility of sharp edges, care should be taken when handling the three piece frame components. The use of protective gloves is recommended.** Place the firefront into position in front of the fire and slide the ashpan door into place. Do not use any other firefront other than the one supplied with this appliance. The firefront shown in these instructions may differ from the one supplied with the appliance.

For single piece frames : Fit the magnets to the backing plates in four corners of the firebox as shown. Follow the frame assembly instructions which are provided with the frame itself.

When the frame is in position, apply the self adhesive sealing strips to the back of the fireframe to give a continuous seal.

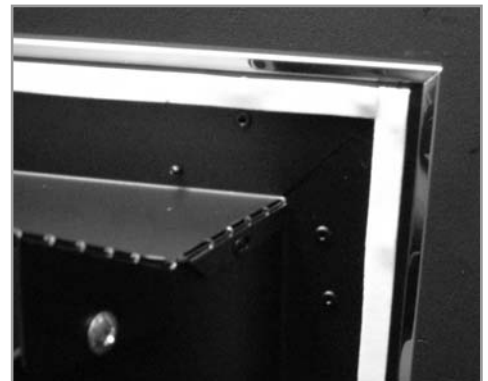

9.0 PREPARING THE OPENING

Before installing the fire, check the flue using a smoke pellet. All of the smoke should travel up the flue and exit correctly from the terminal. If problems are found, DO NOT fit the fire until corrective action is completed.

Protect the decorative hearth whilst pushing the firebox in and out of the opening. Part of the packaging will make an ideal hearth saver pad.

Before running the gas supply into the opening, offer up the firebox to the fireplace to check the fit is good. Angle the firebox or adjust the spigot outlet as described in the Fitting the Firebox section. Ensure that it slides in correctly, the sealing face sits flat and square to the wall or infill panel, and that the base is firm on the floor of the opening as no leaks are permissible here. At this stage it is essential to ensure that the spigot outlet of the fire is not restricted in any way. Remove the firebox and take any necessary measurements before making good and preparing for final installation.

CABLE FIXING. For fixing of the fire by the cable method, see the relevant section. The cable fixing locations should be marked on the back of the opening and the holes drilled. Fit the fibre rawlplugs and eyebolts to these holes. **Note: Plastic rawlplugs are NOT suitable for this application.**

SCREW FIXING. For fixing by screw, mark and drill the fireframe or base, and the relevant points in the opening or on the wall. Rawlplugs will again be required. Pre-punched holes are not provided for this purpose to allow you to choose the optimum positions.

GAS SUPPLY. Following preparation for the fixing method, the concealed gas supply, where required, can now be put into place. Refer to the gas supply section for suggested pipe routes. The ends of the sleeving in which the gas pipe is run should be sealed. The ends of the 8mm supply pipe should be temporarily sealed to prevent the ingress of debris during fixing.

10.0 GAS SUPPLY ROUTING

When the opening is ready for installation of the fire, the gas supply can be routed as shown in the diagrams below. **IMPORTANT -** Wherever a concealed connection is made a rubber grommet must be used to seal the firebox.

Manual control version

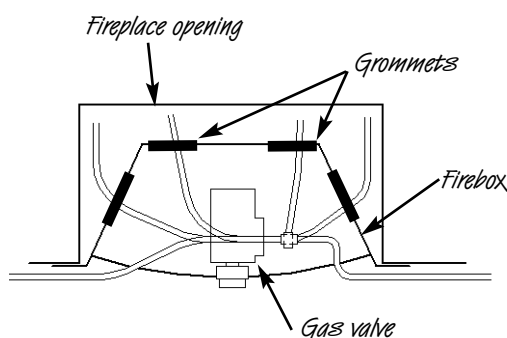

Remote control version

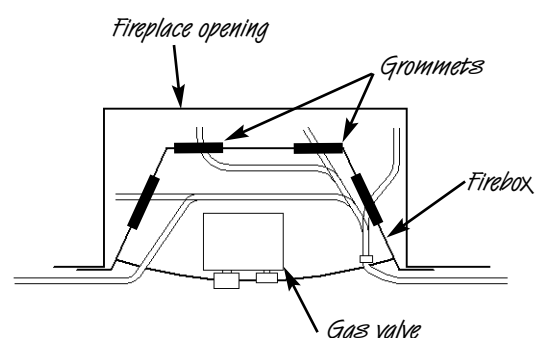

10.0 GAS SUPPLY ROUTING (continued)

The gas pipe must be suitably protected where it passes through fireplace openings. Any sleeving should be sealed to the pipe at its ends. This appliance is fitted with an inlet restrictor elbow.

The open end of the supply pipe should be sealed temporarily during the installation of the firebox to prevent the ingress of dirt and dust.

The appliance firefront is specially notched to allow the gas pipe to pass through when an over hearth supply is necessary.

11.0 FITTING THE FIREBOX

The firebox may be fitted to the opening by using screw fixing or by the cable kit as described in the relevant section. It may be easier to fit the decorative brass fireframe at this stage rather than later if it is a clip-on type. See relevant section for fitting details. Leave the polythene coating in place until fitting procedures are complete to eliminate any risk of scratching the decorative finish.

To fit the firebox, firstly check the fire goes fully back into the opening. If the fire will not fit straight in, tilt the unit backwards and insert the spigot first to lead in to the gather at the top of the fireplace. If this is still not possible, remove the spigot outlet screws using a screwdriver, bend it down and partly insert the firebox. **Now push the outlet deflector back up to the original position** under the lip of the fireplace opening and secure with the screws. The fire is designed to operate correctly with the deflector screwed in its original position and spillage problems may arise by not realigning correctly once fitted.

Secure the fire box by drilling and screwing down the frame or base of the firebox, or use the cable fixing method.

11.1 INSTALLATION BY CABLE FIXING KIT

Drill the four holes for the rawl plugs, as shown in the diagram. If the fireplace configuration does not allow the exact layout given, the eyebolts should be positioned as close to the correct layout as possible.

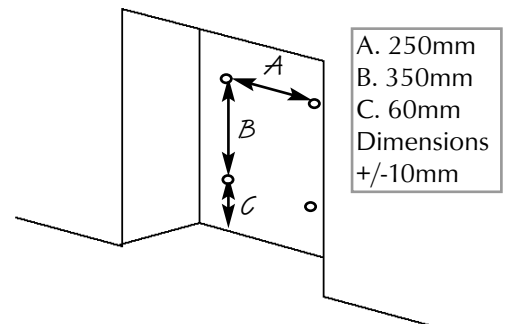

Before finally fitting cables, ensure the self adhesive sealing strips are in position on the back of the appliance frame. The fireframe must be sealed evenly to the fireplace opening all around the periphery.

Thread the tensioning cables through the holes in the top of the firebox, then the eyelets, and finally through the lower holes in the back of the firebox, as shown in the photographs.

Note: The burner tray MUST be removed as per relevant section to gain access to the cable adjusters.

Push the appliance back into to fireplace, centralise, and pull the loose tensioning cables through the holes into the firebox. You may need to temporarily adjust the outlet deflector at this point as described in the Fitting the firebox section. Thread the tensioner bolts onto the cables, with the nuts screwed down close to the tensioner head. Slide the screwed nipple onto the cable, pull cable tight, and tighten nipple.

The tension of the cable may now be adjusted by using a suitable spanner on the tensioner nuts to pull the appliance tightly against the fireplace opening. Visually inspect the seal and reseal if necessary.

Note: DO NOT cut off excess cable. Surplus cable must not be cut off, as it will be impossible to refit the fire after servicing. Coil up the surplus cable, and locate at rear of firebox.

Note : If running a concealed gas supply, ensure grommets are secure around incoming pipes.

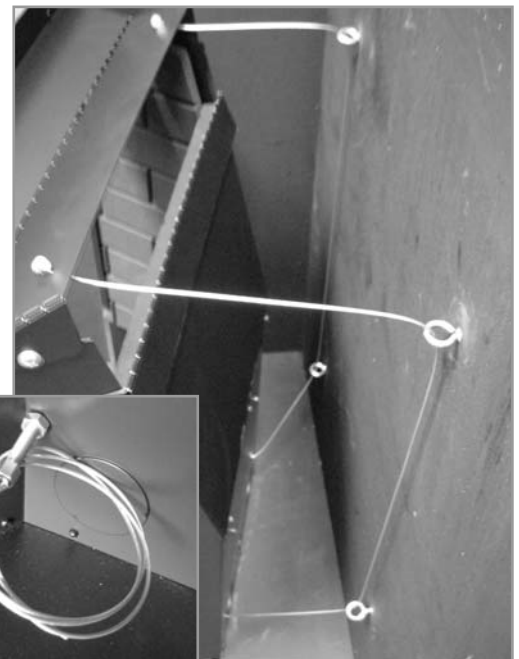

11.2 FITTING THE BURNER TRAY

Important Note: Check the thermocouple nut connection into the rear of the valve is secure.

Temporarily fit the burner tray and ensure a suitable gas route can be achieved. Place the burner tray into the firebox making sure that the rear lugs locate properly on to the ledge in the firebox. Fit the two securing screws through the tray legs to secure the assembly.



11.3 GAS CONNECTION

Purge the gas supply thoroughly to remove air and dirt/debris **BEFORE** connection. Now disconnect the inlet restrictor elbow from the inlet pipe. Connect the previously installed gas supply to inlet restrictor elbow, and re-fit the restrictor elbow to the inlet pipe of the appliance.

If using an across hearth connection, ensure the decorative fireframe and firefront will clear the supply route.

If the data/control plate is not already fitted, attach with two screws, ensuring the control knob is free to be depressed fully.

12.0 FUEL BED LAYOUT (coal effect option)

1. Remove the combustion matrix from its protective packaging, and position onto the burner tray as shown. The front edge of the matrix should sit snugly behind the back edge of the burner rails. Do not fit the matrix on top of the burner rails.

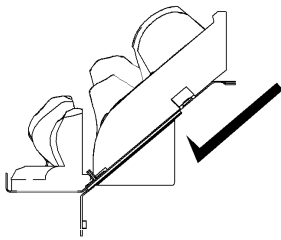

Correct

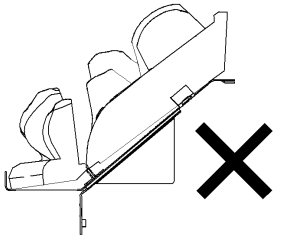

Incorrect

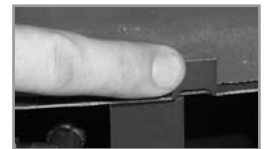
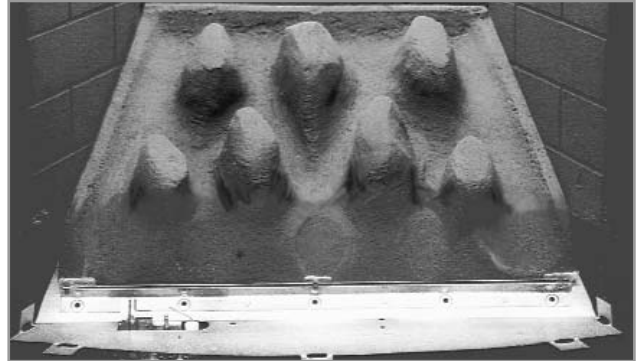

2. Next, remove the front coal strip from its protective packaging and position as shown. The rear edge of the front coal strip should fit in front of the burner rail. Again, do not place on top of the burner rails. When the front coal is in position bend up the three metal tags at the front of the tray to retain (inset).

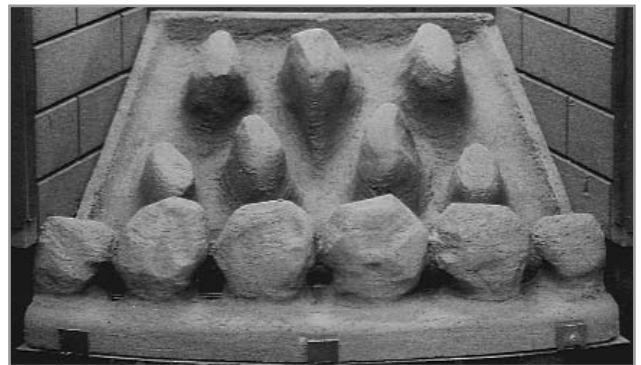

3. Open the bag of 16 moulded coals. All of the coals are the same. Take five coals and place them as shown. Care should be taken to ensure that the coals bridge the gap between the front coal and the four coal supports at the front of the matrix. Care should also be taken not to push the coals right down between the coal supports, as this can detract from the flame picture when the appliance is running.



4. Take five more moulded coals and position as shown to form the 'second row' of the fuel effect. The coals may be rotated as desired to fit into the gaps between the coal supports in order to create a random, realistic effect. Again, remember not to push the coals down too far into the valleys between the coal supports as this can have a detrimental effect to the flame picture.



12.0 FUEL BED LAYOUT (continued)

5. Now take another four coals and place behind the second row of coals, in order to complete the third row. The coals may be orientated as desired to achieve a realistic effect. Keep the spacing between the coals even and uniform. The two coals at the ends of the row may be placed rearwards, towards the back corners of the fuel matrix.

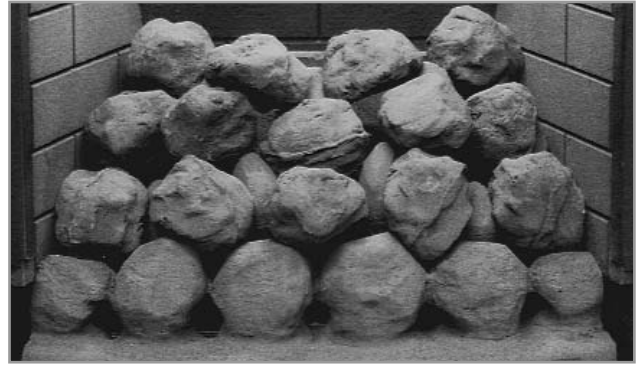

6. Finally, take the two remaining coals and place at the back of the fuel matrix, in the centre as shown. Adding these coals should complete the appearance of the fuel bed giving an even distribution of equally spaced coals.

The fire is designed to operate correctly with the coals supplied when assembled according to the instructions. Never add to the sixteen coals, or change them for a different type. Never throw rubbish or other matter onto the coal bed.



12.1 FUEL BED LAYOUT (pebble effect option)

1. Refer back to section 12.0 - Fuel bed layout (coal effect option) and follow steps 1 and 2. The front strip and fuel effect matrix used for pebble effect versions are of the same design as coal effect versions, but have a different surface finish.

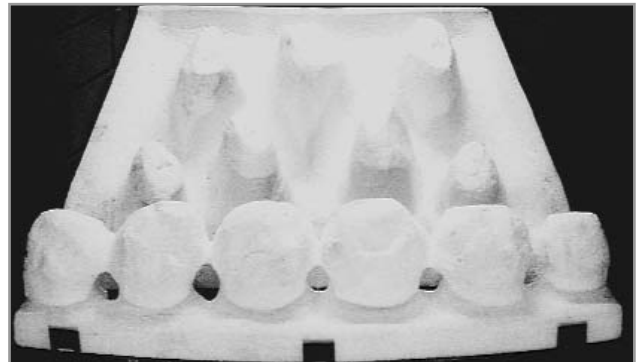

2. Open the bag of 16 ceramic pebbles. All of these pebbles are the same. Take five pebbles and place them as shown. Care should be taken to ensure that the pebbles bridge the gap between the front strip and the four supports at the front of the matrix. Care should also be taken not to push the pebbles right down between the supports, as this can affect the flame picture when the appliance is running.

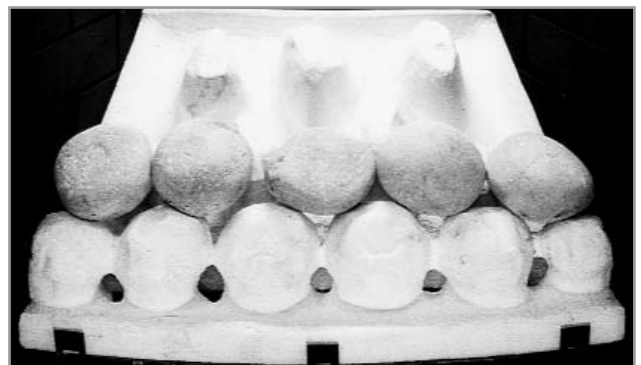

3. Take five more ceramic pebbles and position as shown to form the 'second row' of the fuel effect. The pebbles may be rotated as desired to fit into the gaps between the supports in order to create a random, realistic effect. Again, remember not to push the pebbles down too far into the valleys between the supports as this can have a detrimental effect to the flame picture.

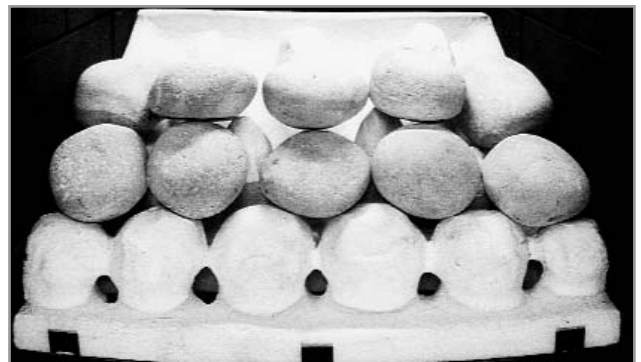

12.1 FUEL BED LAYOUT (continued)

4. Now take another two pebbles and place behind the second row of coals, next to each other in the centre of the fuel bed. The pebbles may be orientated as desired to achieve a realistic effect. Keep the spacing between the pebbles even and uniform.



5. Finally, take the four remaining pebbles and place at the back of the fuel matrix as shown.

Once again, the pebbles may be orientated as desired in order to give a realistic effect. Avoid pushing the pebbles down between the supports. The fuel bed layout is now complete.

The fire is designed to operate correctly with the pebbles supplied when assembled according to the instructions. Never add to the sixteen pebbles, or change them for a different type. Never throw rubbish or other matter onto the coal bed.

Due to the light colour of the pebbles, some discolouration/sooting is to be expected during normal use.

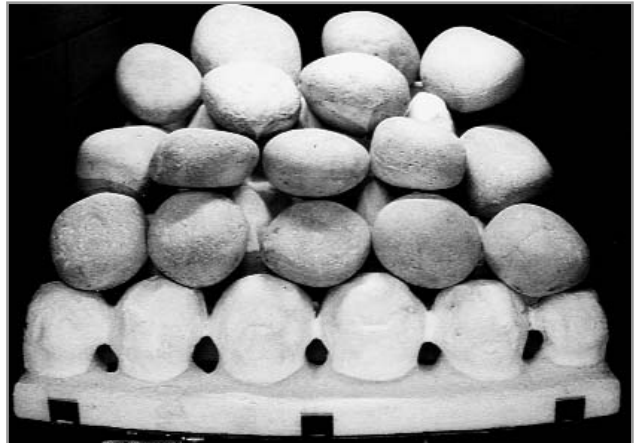

12.2 INSTALLING THE BATTERIES (remote control versions only)

Handset - Remove cover from rear of handset and insert 1 x 'PP3' (9 volt) battery - Replace cover

Appliance - **Ensure appliance is off and cool.** Remove cover from top of receiver box. The cover is protected by reflective foil, and located towards the right hand side, underneath the burner unit. Insert 4 x 'AA' (1.5 volt) batteries - Replace cover.

13.0 FITTING THE FIREFRONT

Place the decorative firefront in front of the fire and slide the ashpan door into place. The firefront shown in these instructions may be different to the one supplied with the appliance.

If the frame supplied is a one-piece magnetic type, then this should be fitted at this stage, place the on the magnet plates in each corner of the firebox as shown. The frame then locates onto the firebox and is held by these magnets.

IMPORTANT : *Due to the possibility of sharp edges, care should be taken when installing the frame components. The use of protective gloves is recommended.*



14.0 TESTING AND COMMISSIONING

Turn on and test the gas supply up to the fire for any leaks, in accordance with current Approved Codes Of Practice (ACOPs).

When the appliance is first used, protective oils coating the firebox may burn off. It is advisable to ventilate the room during this period for at least one hour.

14.1 OPERATING THE APPLIANCE (manual versions)

The pilot is visible through the left hand side of the matrix. Rotate the coals or pebbles for good viewing. Push in and turn the control knob to the SPARK position, and hold there for a few seconds.

Continue turning anti-clockwise through the spark click to the PILOT light position, ensuring the pilot has lit. If not, return the knob clockwise, and repeat.

When the pilot lights after the spark, keep the knob depressed for approximately ten seconds. Now release the knob and the pilot should stay alight. If the pilot is extinguished during use, wait three minutes before repeating the ignition procedure. To achieve the HIGH setting, push the control knob in slightly and continue turning anti-clockwise to the high position. The main burner should light after a few seconds. To decrease the setting to LOW, turn the control knob clockwise to the low setting.



To turn to the PILOT position from the HIGH or LOW positions, press the control knob in, and return to the pilot position and release. To turn the fire OFF, keep the knob pressed in, return to the off position and release.

14.2 OPERATING THE FIRE (remote control versions)

The gas valve has two control knobs ;

Turn the main burner control (shown on left hand side of control valve) knob fully anti-clockwise.

Turn ignition knob (shown on right hand side of control valve) slightly left towards the ignition position until reaching the stop, press down and hold for a few seconds until pilot gas is flowing. Continue pressing down the knob while turning further to the left to activate the piezo spark, continue to hold the knob down for a further 10 seconds after the pilot has been lit. If the pilot does not light repeat the previous steps.

Upon lighting the pilot and after the further 10 seconds, release the knob and turn further to the left to the ON position. The main burner will light and be controlled in accordance with the main burner control knob setting. Adjust the main burner control knob to the desired setting.

If the pilot is extinguished during use of the fire, you must wait three minutes before repeating the ignition procedure.

To turn the main burner OFF whilst keeping the pilot flame lit, turn the ignition control knob to the pilot position then only the pilot will remain lit.

To shut the fire off completely, press the ignition control knob down and continue turning to the right from the pilot position to the OFF position.

A safety interlock prevents re-ignition of the pilot flame until the thermocouple has cooled sufficiently to allow the magnetic valve unit to reset itself.



14.3 OPERATING THE HANDSET (remote control versions)

The remote control unit allows operation of the main burner between maximum and pilot only setting. It does not turn the pilot on or off.

The remote control handset incorporates an inbuilt safety feature to prevent the main burner being activated or turned up accidentally. It is necessary to press button 1 and 2 (see illustration) simultaneously to turn the fire up.

To turn the fire down press button 3 only.

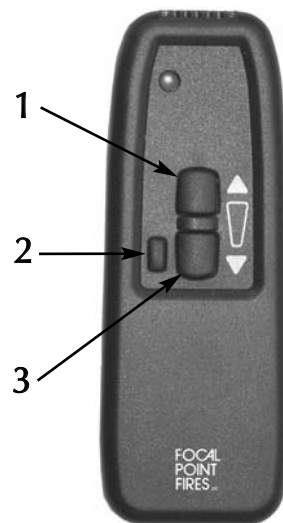

14.4 SPARK FAILURE

The gap between the spark electrode and the pilot should be 3.5 - 4.5mm to produce a good spark. There should be no need to adjust this. If under any circumstances the electric spark fails, the pilot may be lit manually by proceeding with the ignition sequence as previously described, and after turning the control knob through the spark position, the knob should be held in and the pilot lit with a taper.

14.5 SETTING PRESSURE

Remove the screw from the pressure test point, which will be situated on the main injector pipe. Attach a U gauge. Light the fire on the HIGH setting.

The setting pressure should be in accordance with the figures stated on page 2 of these instructions. The fire is factory set to achieve these pressures, and any significant variation could indicate a supply problem.

If the pressure is too high, the gas supply meter may be set incorrectly. This should be checked with the fire running and if necessary reset by the gas supplier. If the pressure is too low, then check the meter governor pressure with the appliance running. If this is incorrect it will need to be reset by the gas supplier.

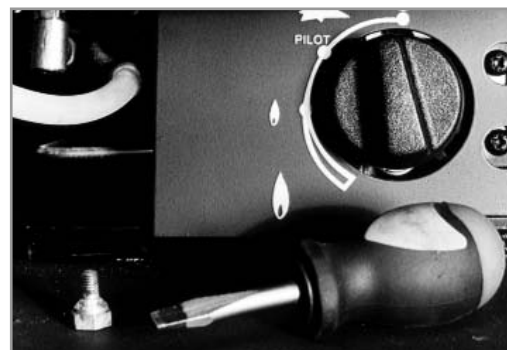

If the setting pressure is too low, but the meter pressure is acceptable, then a problem in the supply pipework is to be suspected. This will be dirt and debris, kinked or inadequate size pipes, restriction in a fitting or solder flashing across a joint. (NOTE: you will not get an accurate reading of the inlet pressure with a pressure gauge on the end of the supply pipe - this is the static pressure in the system. You must use a T piece and measure the supply pressure with the fire on High - the dynamic pressure). Refit and tighten the screw into the pressure test point when the test is complete.

14.6 FLUE SPILLAGE MONITORING SYSTEM

This fire is fitted with a flue spillage safety device (ODS). If the fire shuts down during use for no apparent reason then several things may be suspected. If a door or window has been opened creating a draught, then pilot disturbance is the problem, and removal of the draught should resolve this. The gas pressure reaching the fire must also be checked (again, recall your installer to check and rectify any problem). The thermocouple connection into the back of the gas control valve may also have worked loose during installation, simply get the installer to tighten. If pilot disturbance is not the cause, then the ODS safety system may be in operation. Switch the appliance OFF, check the flue and carry out any remedial work required. Relight the fire and carry out a spillage test. DO NOT allow the appliance to be used if it continues to fail a spillage test.

The aeration hole of the pilot must be carefully cleaned out on each annual service to ensure continued function of the ODS.

The spillage monitoring system shall not be adjusted, modified, or put out of operation by the installer. Any spare parts fitted MUST be of a type supplied for the purpose by the appliance manufacturer. If the fire is not spilling, then further guidance should be sought, using the Troubleshooting section as a guide.

14.7 TESTING FOR SPILLAGE

Close all doors and windows to the room containing the appliance. Let the fire run on HIGH for five minutes. Take a smoke match, light it, and using a smoke match tube, hold it at the top edge of the fire opening, 25mm down and 25mm in. Starting 50mm in from either side, run the smoke match across the opening. All the smoke should be drawn away up the flue. Any smoke returning into the room indicates that spillage is occurring. If the initial spillage test fails, run the fire for a further 10 minutes and repeat the test. When the test has been completed satisfactorily, repeat with any extractor fans in the premises running on the highest setting, and any communicating doors open. Finally, repeat with all doors open.

DO NOT allow the fire to be used until the test is satisfactorily passed.

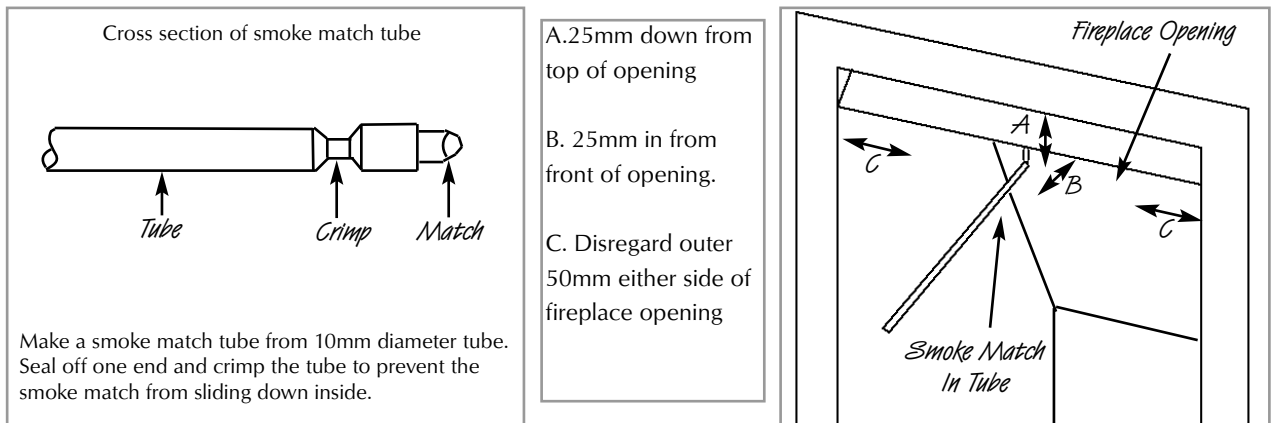

14.8 BRIEFING THE CUSTOMER

All instructions must be handed to the user for safekeeping. Show the customer how to light and control the fire.

After commissioning the appliance, the customer should be instructed on the safe use of the appliance and the need for regular servicing. Frequency of service depends on usage, but MUST be carried out at least once annually.

Advise that cleaning of the fire may be achieved when the fire is cold using a damp cloth and mild detergent on most surfaces.

Scratched and other superficial damage to the matt black paintwork of the appliance can be covered with matching heatproof spray. Use only the manufacturers' recommended spray paint. Paint only when the fire is OFF and cold. Always mask off the surrounding area to prevent contamination with overspray. Ventilate the room during the use of the spray. DO NOT attempt to spray paint the coals or ceramics, or wash them in water.

Advise that the fire will emit a "newness" smell for a time after initial commissioning and that extra ventilation may be needed during this time. Advise that the fire is fitted with a spillage safety device (O.D.S.). If the fire shuts down, this system may be in operation. If spillage is suspected, SWITCH APPLIANCE OFF and call in the installer to investigate any problems.

15.0 SERVICING

Isolate the fire from the gas supply. Ensure that the fire is fully cold before attempting service. A suggested procedure for servicing is detailed below.

1. Lay out the dust sheet and tools.
2. Carefully remove the ceramic components.
3. Remove the cast front fret.
4. Remove the two screws that retain the data/control plate.
5. Disconnect the gas supply, and remove the two securing screws in the tray legs.
6. Remove the burner tray.
7. Remove firebox as described.
8. Check the fireplace opening for rubble accumulation and remove. If debris is excessive, initiate remedial work on the flue.
9. Check the flue with smoke pellet for correct operation.
10. Refit firebox using new seals where necessary

15.0 SERVICING - continued

11. Strip off the burner pipes and clean thoroughly.
12. Clean out the injector, pilot assembly and burner tube. DO NOT remove the pilot injector.
13. Re-assemble and re-fit the burner tray.
14. Turn on the gas supply, and leak test.
15. Refit the decorative casting and ceramics.
16. Check any purpose provided ventilation is un-obstructed.
17. Light the fire and test for spillage.
18. Check setting pressure and safe operation of the appliance.

For specific servicing instructions, see the relevant sections.

15.1 CLEANING THE CERAMIC PARTS

Remove the firefront casting and place to one side. Remove the ceramic components. Gently clean in the open air. Be careful not to create dust from the coals. Where necessary replace damaged components with genuine spares. Seal scrap ceramic components in plastic bags and dispose at proper refuse sites as directed.

Re-fit the coals by referring to the relevant section of these instructions.

15.2 REMOVING THE BURNER TRAY

Remove the decorative front. Remove the ceramics and the data/control plate and place safely aside.

Remove the two screws securing the tray legs to the firebox. Pull tray forward slightly and lift away.

Refitting is the reverse of above, being sure to engage the tray location lugs on the shelf at the rear of the firebox.

15.3 DISMANTLING THE BURNER TRAY

Remove the tray as previously described.

The pilot unit can be removed by withdrawing the tubing nut, the thermocouple nut on the rear of the valve, and the two securing screws, and lifting away. Remove the tubing nut from the valve end of the pilot pipe, and blow through to dislodge any debris.

Remove the two tubing nuts on the ends of the gas pipe to the injector elbow and blow clear. Release the screw through the supporting leg and lift assembly clear. The injector pipe can now be checked for debris. Remove the nut retaining the injector elbow. Blow through the elbow to remove any debris.

The valve is not field serviceable, apart from the pilot filter. Remove the control knob by pulling it forwards, then remove the largest of the three screws on the face of the valve. Slide the filter out and clean away any debris that may have accumulated. The filter element should also be blown clean. This component should not require replacement, however if signs of deterioration are evident then a genuine spare part must be used. If a large amount of debris is present in the filter then the pipework and control should be thoroughly cleaned before re-assembly.

15.4 PILOT ASSEMBLY

Remove the burner tray as in relevant section and pilot unit as described.

Clean the pilot assembly with a soft brush and blow through. Check the aeration holes are free of any dirt or lint. Clean thoroughly internally, the connection can be removed from the base of the pilot unit using two spanners to make cleaning easier. Do not damage or try to remove the pilot injector.

The unit is factory set and the only check necessary is to ensure the spark gap is correct. See specifications for gap setting.

15.5 REMOVING THE FIREBOX

Remove the burner tray as described previously.

Protect the hearth from potential damage. Unroll the coiled tensioner cables from the rear of the firebox. Remove the securing nipples and tensioner adjusters. The firebox is now released from the opening and can be slid outward onto the hearth. Inspect the fireplace opening for debris and if excessive rectify the flue before proceeding further. Check the seal around the fireframe and if necessary replace. Refitting of the firebox is as described in the fitting section of these instructions.

16.0 TROUBLESHOOTING GUIDE

Fire sparks but pilot does not light

No gas to fire, check isolators are open.
Pipework blockage, clean out.
Air not fully purged, repurge supply or wait longer.
Spark earthing to metal work, reset gap correctly.
Blocked pilot, clean out internally.

Pilot lights but then goes out

Severe restriction in gas supply, clear obstruction.
Faulty thermocouple, replace pilot unit.
Hold control knob in for longer.
Check control knob does not foul data plate.
Missing grommet seal in firebox, replace

Fire does not spark at pilot

HT lead detached, refit.
Spark gap too large or small, reset correctly.
Faulty piezo unit, replace.
Debris shorting out electrode, clean.
Spark shorting to metalwork under tray, realign HT lead.

Fire runs for a time and then cuts off

Excessive room draught or flue pull, rectify.
Loose or faulty thermocouple, rectify.
ODS system in operation.
Firebox grommet seal not fitted, rectify.
Lint in pilot aeration hole, clean thoroughly internally

Pilot flame shrinks when fire is on high

Poor gas flow to fire, check pressure with fire on high.
If pressure is low, remove any restriction in pipework or valve.
Check all isolators are adequately sized and fully open.
Check meter pressure is adequate.
Air leak under base of firebox, rectify.
Lint in pilot aeration hole, clean thoroughly internally.
Firebox grommet seal missing, rectify

Fire smells when first lit or in use

Newness smell from brand new appliance.
Spillage occurring. Carry out spillage test and rectify any problems.
Low temperature sealants or combustible materials used in incorrect positions.
Air leak under base of firebox, rectify
Firebox grommet seal missing, rectify.

USER INSTRUCTIONS

<i>Section</i>	<i>Contents</i>	<i>Page No.</i>
1.0	Important Notes	1
2.0	Firefront	2
3.0	Clearances to Combustibles	2
4.0	Ventilation	2
5.0	Operating Instructions	2
6.0	Flue Spillage Monitoring System	2
7.0	Cleaning	3
8.0	Cleaning the Ceramics	3
9.0	Servicing	3
10.0	List of spare parts	3

1.0 IMPORTANT NOTES

The installation of this fire **MUST** only be carried out by a competent person (such as a CORGI registered fitter) in accordance with the Gas Safety (Installation and Use) Regulations 1998, the relevant British Standards, Codes of Practice, the Building Regulations and the manufacturers' instructions.

Failure to comply with the above recommendations could lead to prosecution and invalidate the appliance warranty.

Please ensure you are handed all of the manufacturers documents on completion of the installation. This will include these instructions.

Always keep a note of the installer's name, address and CORGI registration number, the original purchase receipt and the date of installation for future reference.

The fire and flue should be serviced regularly to ensure continued safe operation. See the servicing section for further details. Frequency of service will depend on use, but **MUST** be carried out at least once annually.

Parts of this appliance become naturally hot during use. It is recommended that a suitable fire guard conforming to BS 8423 : 2002 is used, especially where young children, the elderly, or infirm are concerned.

Combustible items, such as flooring and furniture, and soft wall coverings (such as blown vinyl or embossed paper) may discolour if fitted too close to the fire. See relevant section for further details on clearances to combustibles. No combustible material or flooring should protrude onto the hearth.

DO NOT burn any foreign material on this fire, the coals or pebbles must be of the correct type and laid out in accordance with the relevant section of these instructions. Failure to do so could create a hazard or lead to soot-ing.

Before the appliance is installed, the chimney should be swept. All flues should be checked by the installer to ensure there are no defects or obstructions that may prevent the flow of combustion products.

This appliance is fitted with a flue blockage safety device which will shut down the fire if abnormal flue conditions occur. It is **NOT** a substitute for an independently mounted Carbon Monoxide detector.

The fire is only suitable for use with the gas type for which it is supplied.

Remote control models only - This appliance features a battery-operated remote control system. Remote control models, under normal usage will need new batteries approximately every twelve months.

Remote control Handset requirements - 1 x 'PP3' type (9 volt)
Receiver/motor unit requirements - 4 x 'AA' type (1.5 volt)

Refer to the appropriate section of these instructions for details of how to change the batteries.

2.0 FIREFRONT

This fire is supplied with a particular style of firefront. Use of the firefront will ensure an adequate airflow under the firebed for the correct functioning of this appliance.

Compliance with safety standards cannot be guaranteed if another style of front is used.

3.0 CLEARANCES TO COMBUSTIBLES

A combustible shelf may be fixed to the wall above the fire, providing that it complies with the dimensions given below.

<i>Maximum depth of shelf</i>	<i>Minimum distance from finished hearth surface to underside of shelf</i>
100mm (4in)	745mm (29 1/4 in)
150mm (6in)	845mm (33 1/4 in)
203mm (8in)	895mm (35 1/4 in)

A non-combustible shelf may be fitted to within 10mm of the top edge of the fireframe.

Combustible materials, such as wood, may be fitted to within 100mm (4in) of either side of the frame of the appliance, providing the forward projection does not exceed 100mm (4in).

Any combustible side walls must be at least 500mm to the side of the radiant heat source.

As with all heating appliances, any decorations, soft furnishings, and wall coverings (i.e. flock, blown vinyl and embossed paper) positioned too close to the appliance may discolour or scorch.

4.0 VENTILATION

No purpose provided ventilation is normally required for this appliance. The requirements of other appliances operating in the same space or room, and the results of a spillage test must be taken into consideration when assessing ventilation requirements, this will have been carried out by your CORGI registered installer.

For Republic of Ireland, ventilation may be required, see IS 813, ICP3, IS 327, and any other rules in force.

5.0 OPERATING INSTRUCTIONS

The pilot is visible through the underside of the left hand side of the matrix. Push in and turn the control knob to the SPARK position, and hold there for a few seconds.

Continue turning anti-clockwise through the spark click to the PILOT light position, ensuring the pilot has lit. If not, return the knob clockwise, and repeat.

When the pilot lights after the spark, keep the knob depressed for approximately ten seconds. Now release the knob and the pilot should stay alight. If the pilot is extinguished during use, wait three minutes before repeating the ignition procedure.

To achieve the HIGH setting, push the control knob in slightly and continue turning anti-clockwise to the high position. The main burner should light after a few seconds.

To decrease the setting to LOW, turn the control knob clockwise to the low setting.

To turn to the PILOT position from the HIGH or LOW positions, press the control knob in, and return to the pilot position and release.

To turn the fire OFF, keep the knob pressed in, return to the off position and release.



5.1 OPERATING THE FIRE (remote control versions)

The gas valve has two control knobs ;
Turn the main burner control (shown on left hand side of control valve) knob fully anti-clockwise.

Turn ignition knob (shown on right hand side of control valve) slightly left towards the ignition position until reaching the stop, press down and hold for a few seconds until pilot gas is flowing. Continue pressing down the knob while turning further to the left to activate the piezo spark, continue to hold the knob down for a further 10 seconds after the pilot has been lit. If the pilot does not light repeat the previous steps.

Upon lighting the pilot and after the further 10 seconds, release the knob and turn further to the left to the ON position. The main burner will light and be controlled in accordance with the main burner control knob setting. Adjust the main burner control knob to the desired setting.



5.1 OPERATING THE FIRE (continued)

If the pilot is extinguished during use of the fire, you must wait three minutes before repeating the ignition procedure.

To turn the main burner OFF whilst keeping the pilot flame lit, turn the ignition control knob to the pilot position then only the pilot will remain lit.

To shut the fire off completely, press the ignition control knob down and continue turning to the right from the pilot position to the OFF position.

A safety interlock prevents re-ignition of the pilot flame until the thermocouple has cooled sufficiently to allow the magnetic valve unit to reset itself.

5.3 OPERATING THE HANDSET (remote control versions)

The remote control unit allows operation of the main burner between maximum and pilot only setting. It does not turn the pilot on or off.

The remote control handset incorporates an inbuilt safety feature to prevent the main burner being activated or turned up accidentally. It is necessary to press button 1 and 2 (see illustration) simultaneously to turn the fire up.

To turn the fire down press button 3 only.

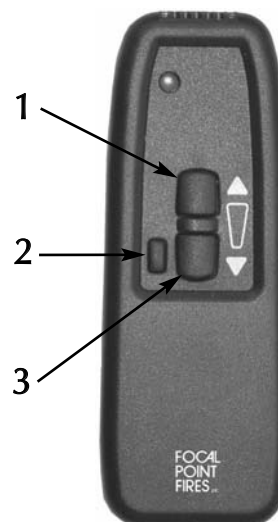

6.0 FLUE SPILLAGE MONITORING SYSTEM

This fire is fitted with a flue spillage safety device (ODS). If the fire shuts down during use for no apparent reason then several reasons may be suspected. If a door or window has been opened creating a draught, then pilot disturbance could be the problem, and removal of the draught should resolve this. The fire can then be re-lit in accordance with the previous section. A grommet seal may also be missing from the firebox causing abnormal draught to shut down the pilot. Call your installer to check seals are properly fitted. If pilot disturbance is not the cause, then the ODS safety system may be in operation. Switch the appliance OFF, call in your installer to check the flue and ventilation and carry out any remedial work required. DO NOT allow the appliance to be used until the flue system is passed as safe.

7.0 CLEANING

Before carrying out any of the following operations, ensure that the fire is OFF and completely cold.

Debris that may form on the firebed should be periodically removed by a competent person. Large deposits could indicate deterioration of the flue. This should be repaired by a competent person, and the fire serviced before further use.

FIREFRONT - Any dust accumulating in the firefront may be removed using a vacuum cleaner or dry cloth. Heavy stains may be removed by using a damp cloth and mild household detergent. Brass parts of the firefront may be cleaned using a suitable brass cleaner. Replace the front centrally against the fire after cleaning.

PAINTED AREAS - These can be cleaned using a dry cloth.

8.0 CLEANING THE CERAMIC PARTS

Remove the firefront casting and place to one side. Remove the ceramic components. Gently clean in the open air. Be careful not to create dust from the ceramics. Where necessary replace damaged components with genuine spares. Seal scrap ceramic components in plastic bags and dispose at proper refuse sites as directed.

Re-fit the ceramic parts by referring to the relevant section of these instructions.

9.0 SERVICING

The fire and flue should be checked on an annual basis to ensure all of the product of combustion are entering the flue and that there is no excessive build up of soot. The frequency of service will depend on usage, but MUST be carried out at least once annually. Servicing must be carried out by a competent person, such as a CORGI registered installer.

Cleaning of the coals/pebbles may be carried out by following the instructions given in the Installation section. The Installation instructions carry full servicing details for the use of the installer.

If debris from the flue or other foreign matter is found on the fire it may indicate a need for servicing. Do not use the fire until the source of the debris has been found and rectified. Air vents (where fitted) should be checked periodically to ensure they are free from obstruction.

10.0 LIST OF SPARES

<i>PART NO.</i>	<i>ITEM</i>	<i>PART NO.</i>	<i>ITEM</i>
CE/F550038	Pack of 16 coals	CE/F780008	Front strip - coal
CE/F550050	Pack of 16 pebbles	CE/F780013	Front strip - pebble
CE/F780007	Ceramic combustion matrix - coal	EL/F930017	Remote handset
CE/F780012	Ceramic combustion matrix - pebble		
CE/FB004050/0	Ceramic pad set (includes rear pad and side pads)		
Please Enquire	Decorative Frame		
Please Enquire	Decorative Front		