

TITAN®

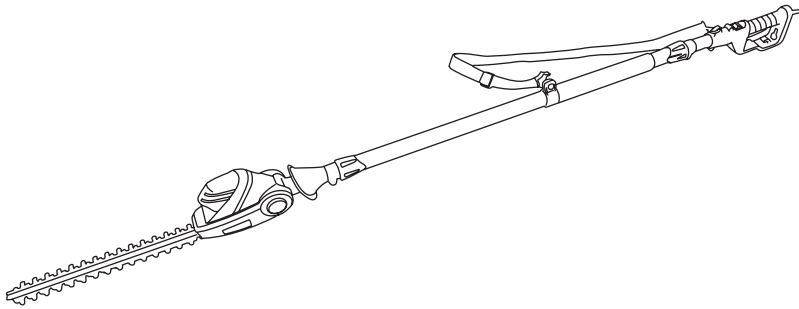

24 month
Manufacturer's
Warranty

SAFETY AND OPERATING MANUAL

Original Instructions

POLE HEDGE TRIMMER 400W TTB427GTM

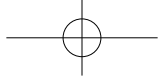

TITAN®

Congratulations on your purchase of a TITAN® product from Titan Power Tool (UK) Ltd. We want you to continue getting the best performance from it so this handbook includes information on safety, handling and care. Please retain this handbook in case you need to refer to any of the information in the future. Your TITAN® product comes with a 24-month guarantee, so should it develop a fault within this period contact your retailer.

GUARANTEE

This TITAN® product carries a guarantee of 24 months. If your product develops a fault within this period, you should, in the first instance contact the retailer where the item was purchased.

This guarantee specifically excludes losses caused due to:

- Fair wear and tear
- Misuse or abuse
- Lack of routine maintenance
- Failure of consumable items (such as batteries)
- Accidental damage
- Cosmetic damage
- Failure to follow manufacturer's guidelines
- Loss of use of the goods

This guarantee does not affect your statutory rights. This guarantee is only valid in the UK.

For any enquiries relating to the guarantee please refer to your retailer.

POLE HEDGE TRIMMER 400W TTB427GTM

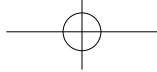

SAFETY INSTRUCTIONS



Warnings! Read this instruction carefully before operating this pole hedge trimmer. Make sure that you are familiar with the controls and properly operate the machine. Following this instructions, you can reduce the risk of fire, electric shock and personal injury.

GENERAL SAFETY INSTRUCTIONS

Read all safety warnings and all instructions. Failure to follow the warnings and instructions may result in electric shock, fire and/or serious injury! Save all warnings and instructions for future reference. The term "garden power tool" in the warnings refers to your mains-operated (corded) garden power tool or battery-operated (cordless) garden power tool!

1. This product is not intended for use by persons (including children) with reduced physical, sensory or mental capabilities, or lack of experience and knowledge, unless they have been given supervision or instruction concerning use of the product by a person responsible for their safety.
2. Children should be supervised to ensure that they do not play with the product.
3. The garden power tool must be kept out of reach of children.
4. Store the instruction manual in a location accessible to all users of the garden power tool and always include the instruction manual when passing it on to other users.
5. Instruct inexperienced persons on the safe use of this garden power tool using this instruction manual.

Work area safety

1. Keep work area clean and well lit. Cluttered or dark areas invite accidents.

2. Do not operate power tools in explosive atmospheres, such as in the presence of flammable liquids, gases or dust. Power tools create sparks which may ignite the dust or fumes.

3. Keep children and bystanders away while operating a power tool. Distractions can cause you to lose control.

Electrical safety

1. Power tool plugs must match the outlet. Never modify the plug in any way. Do not use any adapter plugs with earthed (grounded) power tools. Unmodified plugs and matching outlets will reduce risk of electric shock.

2. Avoid body contact with earthed or grounded surfaces, such as pipes, radiators, ranges and refrigerators. There is an increased risk of electric shock if your body is earthed or grounded.

3. Do not expose power tools to rain or wet conditions. Water entering a power tool will increase the risk of electric shock.

POLE HEDGE TRIMMER 400W TTB427GTM

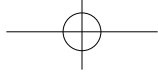

4. Do not abuse the cord. Never use the cord for carrying, pulling or unplugging the power tool. Keep cord away from heat, oil, sharp edges or moving parts.

Damaged or entangled cords increase the risk of electric shock.

5. When operating a power tool outdoors, use an extension cord suitable for outdoor use. Use of a cord suitable for outdoor use reduces the risk of electric shock.

6. If operating a power tool in a damp location is unavoidable, use a residual current device (RCD) protected supply. Use of an RCD reduces the risk of electric shock.

Personal safety

1. Stay alert, watch what you are doing and use common sense when operating a power tool. Do not use a power tool while you are tired or under the influence of drugs, alcohol or medication. A moment of inattention while operating power tools may result in serious personal injury.

2. Use personal protective equipment. Always wear eye protection. Protective equipment such as dust mask, non-skid safety shoes, hard hat, or hearing protection used for appropriate conditions will reduce personal injuries.

3. Prevent unintentional starting. Ensure the switch is in the off-position before connecting to power source and/or battery pack, picking up or carrying the tool. Carrying power tools with your finger on the switch or energising power tools that have the switch on invites accidents.

4. Remove any adjusting key or wrench before turning the power tool on. A wrench or a key left attached to a rotating part of the power tool may result in personal injury.

5. Do not overreach. Keep proper footing and balance at all times. This enables better control of the power tool in unexpected situations.

6. Dress properly. Do not wear loose clothing or jewellery. Keep your hair, clothing and gloves away from moving parts. Loose clothes, jewellery or long hair can be caught in moving parts.

7. If devices are provided for the connection of dust extraction and collection facilities, ensure these are connected and properly used. Use of dust collection can reduce dust-related hazards.

Garden power tool use and care

1. Do not force the garden power tool. Use the correct garden power tool for your application. The correct garden power tool will do the job better and safer at the rate for which it was designed

2. Do not use the garden power tool if the switch does not turn it on and off. Any garden power tool that cannot be controlled with the switch is dangerous and must be repaired.

3. Disconnect the plug from the power source and/or the battery pack from the

POLE HEDGE TRIMMER 400W TTB427GTM

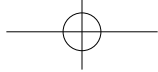

garden power tool before making any adjustments, changing accessories, or storing garden power tools. Such preventive safety measures reduce the risk of starting the power tool accidentally.

4. Store idle garden power tools out of the reach of children and do not allow persons unfamiliar with the garden power tool or these instructions to operate the garden power tool. Garden power tools are dangerous in the hands of untrained users.

5. Maintain garden power tools. Check for misalignment or binding of moving parts, breakage of parts and any other condition that may affect the garden power tool's operation. If damaged, have the garden power tool repaired before use. Many accidents are caused by poorly maintained garden power tools.

6. Keep cutting tools sharp and clean. Properly maintained cutting tools with sharp cutting edges are less likely to bind and are easier to control.

7. Use the garden power tool, accessories and tool bits etc. in accordance with these instructions, taking into account the working conditions and the work to be performed. Use of the garden power tool for operations different from those intended could result in a hazardous situation.

Service

Have your garden power tool serviced by a qualified repair person using only identical replacement parts. This will ensure that the safety of the garden power tool is maintained.

POLE HEDGE TRIMMER SAFETY WARNINGS

1.Keep all parts of the body away from the cutter blade. Do not remove cut material or hold material to be cut when blades are moving. Make sure the product is switched off when clearing jammed material. A moment of inattention while operating the product may result in serious personal injury.

2.Carry the product by the handle with the cutter blade stopped. When transporting or storing the product always fit the cutting device cover. Proper handling of the product will reduce possible personal injury from the cutter blades.

3.Hold the product by insulated gripping surfaces only, because the cutter blade may contact hidden wiring or its own cord. Cutter blades contacting a "live" wire may make exposed metal parts of the product "live" and could give the operator an electric shock.

4.Keep cable away from cutting area. During operation the cable may be hidden in shrubs and can be accidentally cut by the blade.

5.Check the hedge for foreign objects before operation, e.g. wire fences.

6.Hold the product properly, e.g. with both hands if two handles are provided. Loss of control can cause personal injury.

POLE HEDGE TRIMMER 400W TTB427GTM

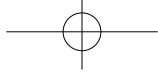

ADDITIONAL SAFETY WARNINGS

IMPORTANT

Read carefully before use
Keep for future reference

Training

1. Become familiar with the instruction manual before attempting to operate the product.

Preparation

1. This product can cause serious injuries. Read the instructions carefully for the correct handling, preparation, maintenance, starting and stopping of the product. Become familiar with all controls and the proper use of the product.

2. Never allow children to use the product.

3. Beware of overhead power lines. Do not use the product in any position that causes any part to come within 10 m of overhead electrical lines.

4. Avoid operating while people, especially children, are nearby.

5. Dress properly! Do not wear loose clothing or jewellery, which can be caught in moving parts. Use of sturdy gloves, non-skid footwear and safety glasses is recommended.

6. If the cutting mechanism strikes any foreign object or the product starts making any unusual noise or vibration, switch the product off, allow the product to stop, disconnect it from the power supply and let it cool down. Take the following steps:

- inspect for damage,
- check for, and tighten, any loose parts,
- have any damaged parts replaced or repaired with parts having equivalent specifications.

Operation

1. Provide instructions for correct use and an indication that the hedge trimmer should not be used for any other purpose, as well as the following instructions.

2. Stop the motor before

- cleaning or when clearing a blockage,
- checking, carrying out maintenance or working on the product,
- adjusting the working position of the cutting device,
- leaving the product unattended.

3. Ensure that the product is correctly located in a designated working position before starting the motor.

4. While operating the product, always ensure that the operating position is safe and secure. Do not use this product on steps or a ladder.

5. Do not operate the product with a damaged or excessively worn cutting device.

POLE HEDGE TRIMMER 400W TTB427GTM



6. Always ensure that all handles and guards are fitted when using the product. Never attempt to use an incomplete product or one fitted with an unauthorised modification.

7. Always use two hands to operate a product fitted with two handles.

8. Always be aware of your surroundings and stay alert for possible hazards of which you may not be aware due to the noise of the product.

Maintenance and storage

1. When the product is stopped for servicing, inspection or storage, shut off the power source, disconnect the product from the power supply and make sure all moving parts have come to a stop. Allow the product to cool before making any inspections, adjustments, etc.

2. Always allow the product to cool down before storing.

3. When transporting or storing the product, always fit the cutting device transport guard.

VIBRATION AND NOISE REDUCTION

To reduce the impact of noise and vibration emission, limit the time of operation, use low-vibration and low-noise operating modes as well as wear personal protective equipment.

Take the following points into account to minimise the vibration and noise exposure risks:

1. Only use the product as intended by its design and these instructions.

2. Ensure that the product is in good condition and well maintained.

3. Use correct application tools for the product and ensure they in good condition.

4. Keep tight grip on the handles/grip surface.

5. Maintain this product in accordance with these instructions and keep it well lubricated (where appropriate).

6. Plan your work schedule to spread any high vibration tool use across a number of days.

The European Physical Agents (Vibration) Directive has been brought in to help reduce hand arm vibration syndrome injuries to users of product's with vibration emission. The directive requires manufacturers and suppliers to provide indicative vibration test results to enable users to make informed decisions as to the period of time a product can be used safely on a daily basis and the choice of tool. Further Advice can be found at www.hse.gov.uk

POLE HEDGE TRIMMER 400W TTB427GTM

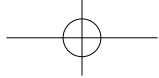

EMERGENCY

Familiarise yourself with the use of this product by means of this instruction manual. Memorise the safety directions and follow them to the letter. This will help to prevent risks and hazards.

1. Always be alert when using this product, so that you can recognise and handle risks early. Fast intervention can prevent serious injury and damage to property.

2. Switch off and disconnect from the power supply if there is any malfunction. Have the product checked by a qualified specialist and repaired, if necessary, before you put it into operation again.

POLE HEDGE TRIMMER 400W TTB427GTM

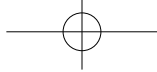

VIBRATION

The European Physical Agents (Vibration) Directive has been brought in to help reduce hand arm vibration syndrome injuries to power tool users. The directive requires power tool manufacturers and suppliers to provide indicative vibration test results to enable users to make informed decisions as to the period of time a power tool can be used safely on a daily basis and the choice of tool.

Further Advice can be found at www.hse.gov.uk

Vibration total values (triax vector sum) determined according to EN ISO 10517 and EN60745:	
Vibration level for operation	Vibration emission value $a_h = 1.656 \text{ m/s}^2$
	Uncertainty $K = 1.5 \text{ m/s}^2$

The declared vibration emission value should be used as a minimum level and should be used with the current guidance on vibration.

Calculating the actual period of the actual period off use can be difficult and the HSE website has further information.

The declared vibration emission been measured in accordance with a standard listed test stated above and may be used to compare one tool with another. The declared vibration emission value may also be used in a preliminary assessment of exposure.



WARNING! The vibration emission value during actual use of the power tool can differ from the declared value depending on the ways in which the tool is used dependant on the following examples and other variations on how the tool is used:

How the tool is used and the materials being ground or cut.

The tool being in good condition and well maintained.

The use the correct accessory for the tool and ensuring it is sharp and in good condition.

The tightness of the grip on the handles.

And the tool is being used as intended by its design and these instructions.

This tool may cause hand-arm vibration syndrome if its use is not adequately managed.



WARNING! identify safety measures to protect the operator that are based on an estimation of exposure in the actual conditions of use (taking account of all parts of the operating cycle such as the times when the tool is switched off and when it is running idle in addition to the trigger time). Note The use of other tools will reduce the users' total working period on this tool.

Helping to minimise your vibration exposure risk.

Maintain this tool in accordance with these instructions and keep well lubricated (where appropriate).

Avoid using tools in temperatures of 10°C or less.

Plan your work schedule to spread any high vibration tool use across a number of days. Health Surveillance.

POLE HEDGE TRIMMER 400W TTB427GTM

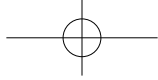

Health Surveillance.

All employees should be part of an employer's health surveillance scheme to help identify any vibration related diseases at an early stage, prevent disease progression and help employees stay in work.

Double insulation:

The tool is double insulated. This means that all the external metal parts are electrically insulated from the mains power supply. This is done by placing insulation barriers between the electrical and mechanical components making it unnecessary for the tool to be earthed.

Important note:

Be sure the supply is the same as the voltage given on the rating plate. The tool is fitted with a two-core cable and plug. Remove the mains plug from socket before carrying out any adjustment or servicing.

POLE HEDGE TRIMMER 400W TTB427GTM

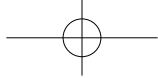

SYMBOLS



Warning



Read the instruction manual



Double insulation



Compliance with relevant safety standards



Wear ear protection



Wear eye protection



Wear helmet protection



Wear safety helmet!



Wear face protection!



Gloves with saw protection



Boots with saw protection, steel toecap and non-slip sole



Wear protective clothing



To avoid potential electric shock, do not use the unit in humid or wet



Switch off! Remove plug from mains before cleaning or maintenance



Switch off! Remove plug from the mains immediately if the cable is damaged or cut.

POLE HEDGE TRIMMER 400W TTB427GTM

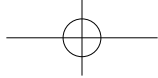

Objects thrown by the product could hit the user or other bystanders. Always ensure that other people and pets remain at a safe distance from the product when it is in operation. In general, children must not come near the area where the product is. Minimum distance 15 m.



Always beware of the danger from overhead electric-power line, keep a safe distance at least 10M from the power line.



Waste electrical products should not be disposed of with household waste, please recycle where facilities exist. Check with your local authority or retailer for recycling advice.



Guaranteed sound power level

POLE HEDGE TRIMMER 400W TTB427GTM

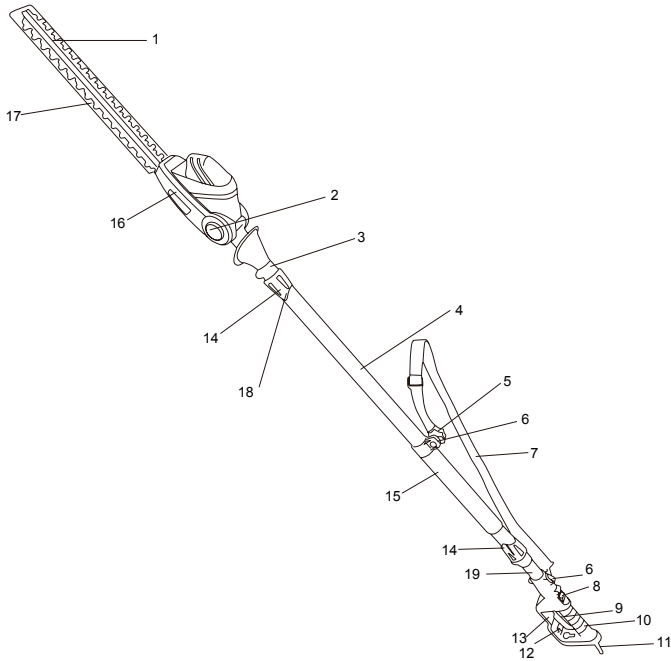
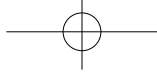

- 1. Cutting blade**
- 2. Lock-off button for cutting angle adjustment**
- 3. Upper shaft**
- 4. Middle shaft**
- 5. Fixation knob**
- 6. Securing clip (upper/lower)**
- 7. Harness**
- 8. Lock-off button**
- 9. Switch trigger**
- 10. Main handle**
- 11. Power cord with plug**
- 12. Cord strain relief**
- 13. Rear safe guard**
- 14. Bolt**
- 15. Soft grip**
- 16. Cooling air vents**
- 17. Blade protection sheath**
- 18. Locking pin**
- 19. Lower shaft**

POLE HEDGE TRIMMER 400W TTB427GTM

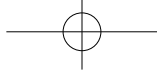

TECHNICAL DATA

Rated voltage	230-240VAC 50Hz
Rated power	400W
No-load speed	1850/min
Cutting blade length	450mm
Max. cutting length	410mm
Max. cutting capability	16mm
Net weight	4 kg
Cable length	10m

NOISE AND VIBRATION DATA

Measured sound pressure level	83.7 dB(A), K=1.051 dB(A)
Measured sound power level	95.8 dB(A), K=1.051 dB(A)
Guaranteed sound power level	97 dB(A)
Vibration	1.656 m/s ² , K=1.5m/s ²

The declared vibration value has been measured in accordance with a standard test method and may be used for comparing one tool with another.

The declared vibration value may also be used in a preliminary assessment of exposure.

WARNING! The vibration emission value during actual use of the tool can differ from the declared value depending on the ways in which the tool is used. Identify safety measures to protect the operator that are based on an estimation of exposure in the actual conditions of use (taking account of all parts of the operating cycle such as the times when the tool is switched off and when it is running idle in addition to the trigger time).

The sound intensity level for the operator may exceed 85dB(A) and ear protection measures are necessary.

ACCESSORIES

HARNESS **1PC**

HEX KEY **1PC**

POLE HEDGE TRIMMER 400W TTB427GTM



OPERATION INSTRUCTIONS



WARNING! Read all instructions carefully. Do not connect the pole hedge trimmer to mains supply power before it is completely assembled. Always use gloves during assembly.

1. INTENDED USE

1). This pole hedge trimmer TTB427GTM is designated with a rated power of 400Watts. This product is intended for cutting and trimming of high and wide hedges, bushes and shrubs in domestic gardens.

The maximum cutting capacity must be observed. Do not cut branches exceeding the stated maximum capacity.

2). The use of this product in case of rain or humid environment is prohibited.

3). This product is intended for private domestic use only, not for any trade use. It must not be used for any purposes other than those described.

2. ASSEMBLY INSTRUCTIONS

1). UNPACK

a). Unpack all parts and lay them on a flat, stable surface.

b). Remove all packing materials and shipping devices if applicable.

c). Make sure the delivery contents are complete and free of any damage. If you find that parts are missing or show damage do not use the product but contact your dealer. Using an incomplete or damaged product represents a hazard to people and property.

d). Ensure that you have all the accessories and tools needed for assembly and operation. This also includes proper personal protective equipment.

2). ASSEMBLY



WARNING! Once assembled the product, the telescopic shaft can be disassembled to replace inner cable during maintenance. (See "MAINTENANCE" description)

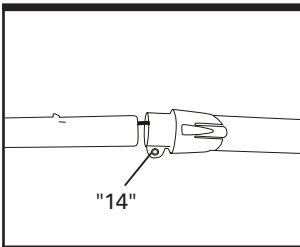

Fig. 1

After unpacking, assembly is required.

a). Loosen the bolts (14) with a supplied hex key,

b). Align the middle shaft (4) with the lower shaft (19) and insert it until nipple snaps into place audibly. (See Fig. 1).

c). Repeat in the same way for middle shaft (4) and upper shaft (3).

POLE HEDGE TRIMMER 400W TTB427GTM

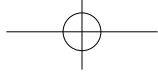

3). HARNESS



WARNING! Always operate using the harness provided. Failure to do so could result in loss of balance and result in personal injury.

- a). Open the securing clip (6) to remove the harness from the loop.
- b). Place the harness so that it runs over the left shoulder, crossing the chest and back. (See Fig. 2a)
- c). Locate the product to the harness by using the securing clip.
- d). Adjust the position of the upper securing clip loosening the fixation knob anticlockwise and sliding it into required position. (See Fig. 2b)
- e). To allow safe and comfortable use, the lower shaft should be adjusted so that the upper and lower Harness Securing Clips (6) are approximately the same width as the user's shoulders.

NOTE: The lower adjustable section is NOT to increase the cutting length but to alter the harness positions.

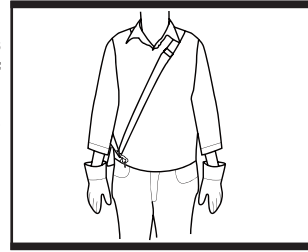

Fig. 2a

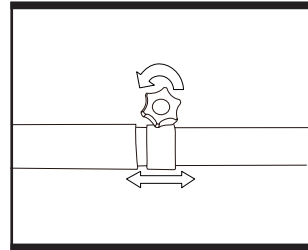

Fig. 2b

3. CABLE ROUTING

1). Always route the electric main cable away from the work area to prevent it from coming into contact with the blade. Plan your route before starting work. Start your work at the nearest point to the electrical outlet, and work away from it. This will keep the cable away from the tool and avoid it being accidentally cut. Keep the cable over your shoulder for added safety.

2). For tension relief of the cable, form a loop of the end of the main cable and bring this through the opening at the handle and insert it into the cord strain relief (12). (See Fig.3)

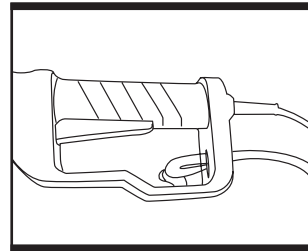

Fig. 3

4. POWER CONNECTION



WARNING! Before operating the pole hedge trimmer, ensure that the fastening elements are undamaged. In order to prevent risk, always switch off the motor and pull out the mains plug before starting this task.

POLE HEDGE TRIMMER 400W TTB427GTM

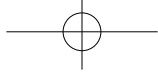

The pole hedge trimmer can be connected to any socket (with 230-240V alternating current).

Always use the appliance via a Residual Current Device (RCD) with a tripping current of max. 30mA.

1). Use only rubber-insulation-sheath extension cables suitable for outdoor use. The recommended size of extension cord is not lighter than 1.5mm² and a maximum of 10meters in length.

2). Mains leads on pole hedge trimmer are particularly susceptible to insulation damage. The causes of this include the following:

- Cut the cable by passing over it with the pole hedge trimmer.
- Damage through crushing if the mains lead is routed under doors or windows.
- Cracks caused by ageing of the insulation sheath.
- Kinks caused by incorrect fastening or routing of the mains lead.

3). Such damaged mains leads should not be used under any circumstances as they may cause fatal injuries due to their damaged insulation sheath.

4). Always check the plug and cable and make sure they are in good condition before operation.

5. CUTTING LENGTH ADJUSTMENT



WARNING! Always switch the motor off and pull the mains plug from power supply before any adjustment.



WARNING! The length of the shaft is limited! Stop pushing/pulling as soon as you feel a resistance! Extend the shaft only to the length required to reach the hedges being trimmed! Do not attempt to use the product at a length which does not allow you to achieve proper footing and balance at all times!

The cutting length of the pole hedge trimmer can be adjusted continuously according to required cutting height.

1). Unscrew the bolt (14) with a supplied hex key(See Fig.1a).

2). Push the shafts (3, 4) towards each other to shorten or pull away from each other to lengthen the shaft.

3). Tighten the bolts (14) once the desired length is adjusted.

POLE HEDGE TRIMMER 400W TTB427GTM



NOTE: The lower adjustable section is NOT to increase the cutting length but to alter the harness positions.

6. CUTTING ANGLE ADJUSTMENT



WARNING! Always switch the motor off and pull the mains plug from power supply before any adjustment.

This pole hedge trimmer supplied 4 cutting position for different cutting status, adjust the cutting head angle to fit the growth of the plant.

1). Push lock-off buttons (2) on the left and right of the trimming head. (See Fig. 4a).

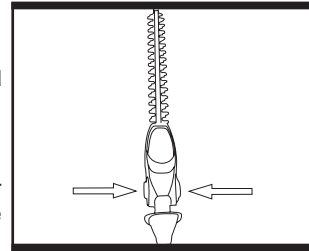

Fig. 4a

2). Adjust the head until it snaps securely into place at one of the four positions indicated by the notches. (See Fig. 4b).

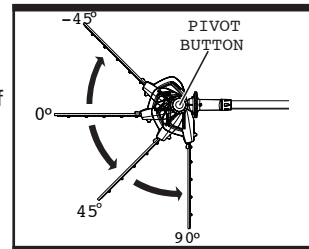

Fig. 4b

7. STARTING AND STOPPING

1). STARTING

The pole hedge trimmer is fitted with a lock-off button feature. To start the pole hedge trimmer, simply pull the lock-off button (8) and hold it in position then fully press and hold the switch trigger (9) to switch the product on. (See Fig.5a)

NOTE: It is not necessary to maintain pressure on the lock-off button once the switch trigger is squeezed and the motor is running. The lock-off button is a safety device to avoid accidental start-up of the device.

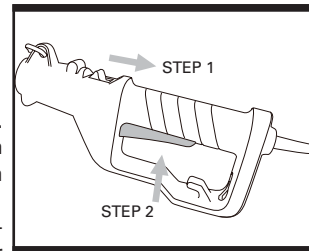

Fig. 5a

POLE HEDGE TRIMMER 400W TTB427GTM

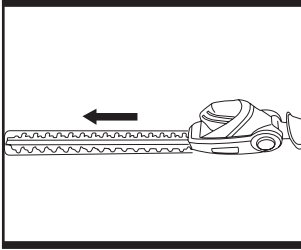
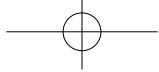

Fig. 5b

2). STOPPING

a). The pole hedge trimmer will automatically stop once the switch trigger (9) is released. The lock-off button will have to be depressed and the switch trigger squeezed to restart the tool.

b). When the blade has come to a complete stop, remove plug from power source and replace the blade protection sheath.

3). REMOVE BLADE PROTECTION SHEATH

a). Remove the blade protection sheath from the blade before operation. (See Fig. 5b)

b). Refit the blade protection sheath when the product is not in use, for storage or transportation.

8. GENERAL BEHAVIOUR

1). Check the product as well as accessories for damage before each use. Do not use the product if it is damaged or shows wear.

2). Double check that accessories and blade are properly fixed.

3). Always hold the product the product by its handle and gripping surface. Keep them dry to ensure safe support.

4). Ensure that the air vents are always unobstructed and clean. Clean them if necessary with a soft brush. Blocked air vents may lead to overheating and damage the product.

5). Switch the product off immediately if you are disturbed while working with it and when other people enter the working area. Always let the product come to complete stop before putting it down.

6). Do not overwork yourself. Take regular breaks to ensure you can concentrate on the work and have full control over the product.



Fig. 6a

9. HEDGE TRIMMING

1). Adjust the shaft to required length as described above.

2). Cut and remove branches exceeding the cutting capacity of this product using a proper pruner before operation.

3). Always hold the product firmly with both hands on soft grip (15) and main handle (10). Never operate this product using only one hand.

4). Cut both sides from the bottom cutting upwards to the top. This will prevent any of the cuttings falling into the path of the area still to be cut. (See Fig. 6a).



Fig. 6b

5). After cutting the sides proceed to the top.

POLE HEDGE TRIMMER 400W TTB427GTM



6). When cutting wide hedges with the cutting area in sight move the cutting blade lightly through the cutting surface in a sweeping motion following the shape of the hedge or shrub. A slight tilt downwards of the cutting blade in the direction of motion is recommended for optimum cutting performance.

(See Fig. 6b).

7). Move the product with slow motion forward when cutting higher hedge and the cutting area out of sight. (See Fig. 6c).

8). Do not to rush and do not attempt to cut too much with one stroke of the cutting blade.

NOTE: Try to keep the cutting blade angled at approximately 15° to the cutting surface.

9). Cut in a number of stages if the area being cut is particularly long to achieve a better result; smaller cuttings will allow for easy composting.

NOTE: When shaping it is advisable to achieve a trapezoidal shape (See Fig. 6d). A trapezoidal cut corresponds to the natural growth of plants and results in optimal hedge growth, as it will expose more light to the bottom of the hedge.



Fig. 6c

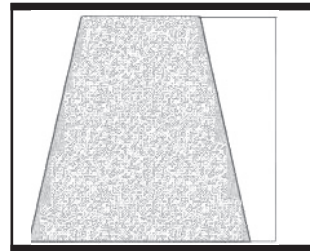
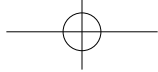

Fig. 6d

POLE HEDGE TRIMMER 400W TTB427GTM



MAINTENANCE



WARNING! Before carrying out any repairs or servicing work, you must ensure that the pole hedge trimmer has been disconnected from the power supply. Repairs and maintenance work other than described within this instruction manual may be performed only by qualified specialist!

1. SERVICE

To ensure long and reliable service, carry out the following maintenance regularly. Servicing and cleaning work on the pruner and the removal of the guards may only be carried out after the motor has been switched off and the plug disconnected from the power supply.

- 1). Keep the product clean. Remove debris from it after each use and before storage.
- 2). Regularly check for obvious defects such as loose, dislodged or damaged blade, loose fixings and worn or damaged components.
- 3). Clean the product with a dry cloth. Use a brush for areas that are hard to reach.
- 4). In particular clean the air vents after every use with a cloth and brush.
- 5). Clean the pole hedge trimmer with a brush or cloth. Do not use any solvents or water to remove dirt. Remove stubborn dirt with high pressure air (max. 3 bar).
- 6). Do not clean the pole hedge trimmer while it is running.
- 7). Ensure that all the fastening elements (screws, nuts, etc.) are tight at all times so that you can safely work with the pole hedge trimmer.
- 8). Check the pole hedge trimmer frequently for signs of wear. Replace worn or damaged parts.
- 9). Store your pole hedge trimmer in a dry place. To ensure a long service life all screw parts should be cleaned and then oiled.
- 10). The component that is subject to most wear is the cutting blade. You should therefore check the condition of the cutting blade and its mounting at regular intervals.
 - If the cutting blade is worn or blunt it must be replaced immediately;
 - If the pole hedge trimmer starts to suffer from excessive vibrations, this means that the cutting blade has suffered deformation due to impacts. In this case it must be repaired or replaced.

POLE HEDGE TRIMMER 400W TTB427GTM

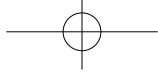

2. LUBRICATE CUTTING BALDE

- 1). Keep the blade (1) clean and free of debris. Remove trimmings.
- 2). Keep the blade (1) sharp to retain a good cutting performance. Replace a worn or damaged cutting blade with a new one of the same type.
- 3). Lubricate the blade (1) after each use to prolong the life span of cutting blade and product. Apply light machine oil along the edge of the cutting blade. (See Fig. 7).

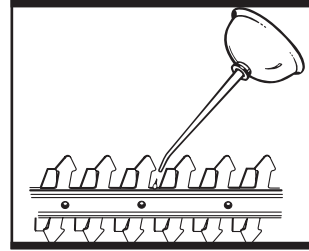

Fig. 7

3. REPAIR

This product does not contain any parts that can be repaired by the consumer. Contact a qualified specialist to have it checked and repaired.

To separate the shaft to enable cable replacement, press the locking pin (18) with a appropriate tool and then pull middle shaft (4) away from upper shaft (3). Repeat in the same way for middle shaft (4) and lower shaft (19).(See Fig.8)
Now, you can replace any worn inner cable.

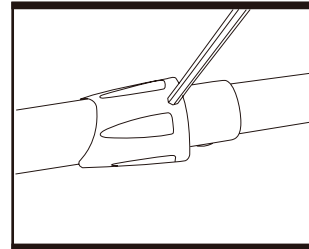

Fig. 8

4. STORAGE

- 1). Clean the product as described above.
- 2). Store the product and its accessories in a dry, frost-free, well-ventilated place.
- 3). Always store the product in a place that is inaccessible to children. The ideal storage temperature is between 10 and 30°C.
- 4).We recommend covering the product with a proper cloth or enclosure to protect against dust.

5. TRANSPORTATION

- 1). Switch the product off and disconnect it from the power supply before transporting it anywhere.
- 2). Attach transportation guards as described, if applicable.
- 3). Always carry the product by its handle/gripping surface.
- 4). Protect the product from any heavy impact or strong vibrations which may occur during transportation in vehicles.
- 5). Secure the product to prevent it from slipping or falling over.

POLE HEDGE TRIMMER 400W TTB427GTM

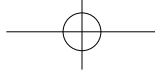

TROUBLESHOOTING

WARNING! Only perform the steps described in these instructions! All further inspection, maintenance and repair work must be performed by a qualified specialist! Contact a specialist if the problem cannot be solved by yourself!

WARNING! Only perform the steps described within these instructions! All further inspection, maintenance and repair work must be performed by an authorised service centre or a similarly qualified person if you cannot solve the problem yourself!

Problem	Possible cause	Fault correction
Product does not start	Not connected to power supply	Connect to power supply
	Power cord or plug is defective	Check by a specialist electrician
	Other electrical defect to the product	Check by a specialist electrician
Product does not reach full power	Extension cord not suitable for operation with this product	Use a suitable extension cord
	Power source (e.g. generator) has too low a voltage	Connect to another power source
	Air vents are blocked	Clean the air vents
Unsatisfactory result	Blade is worn	Have it replaced with a new one
	Thickness of branches exceeds capacity	Only cut branches within the limits
Excessive vibration/noise or exhaust	Blade is dull/damaged	Replace with a new one
	Bolts/nuts are loosen	Tighten bolts/nuts

ENVIRONMENTAL PROTECTION



Waste electrical products should not be disposed of with household waste. Please recycle where facilities exist. Check with your Local Authority or retailer for recycling advice.

For further information visit www.recycle-more.co.uk.

POLE HEDGE TRIMMER 400W TTB427GTM



UK PLUG REPLACEMENT

The fuse in the main plug of your garden power tool should always be replaced with one of identical rating.

Check the voltage given on your garden power tool matches the supply voltage.

The garden power tool is supplied with a fitted plug, however if you should need to fit a new plug follows the instruction below.

IMPORTANT:

The wires in the mains lead are coloured in accordance with the following code:

Blue – Neutral

Brown – Live

As the colours of the wires in the mains lead of this appliance may not correspond with the coloured markings identifying the terminals in your plug, proceed as follows:

The wire which is coloured **blue** must be connected to the terminal which is marked with N.

The wire which is coloured **brown** must be connected to the terminal, which is marked with the letter **L**.

Warning: Never connect live or neutral wires to the earth terminal of the plug.

A 13 AMP plug (approved by BS1363/A) must be used and a 5 AMP fuse must be fitted.

NOTE: If a moulded plug is fitted and has to be removed take great care in disposing of the plug and severed cable, it must be destroyed to prevent engaging into a socket. If the supply cord is damaged it must be replaced by a service agent or a similarly qualified person in order to avoid hazard.

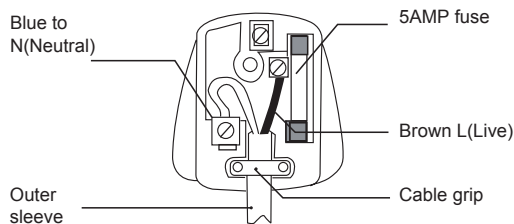

POLE HEDGE TRIMMER 400W TTB427GTM

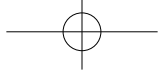

TITAN®

Declaration of Conformity

We, Importer
TITAN Power Tools (UK) Ltd
Trade House, Mead Avenue, BA22 8RT

Declare that the product:
Designation: **400W POLE HEDGE TRIMMER**
Model: **TTB427GTM**

Complies with the following directives:
2006/42/EC - Machinery Directive
2004/108/EC - Electromagnetic Compatibility Directive
2006/95/EC - Low Voltage Directive
2000/14/EC amended by 2005/88/EC - Noise Emission in the Environment by Equipment for Use Outdoors Directive
2002/95/EC - Restrictions of the Use of Certain Hazardous Substances in Electrical and Electronic Equipment
2002/96/EC and 2003/108/EC - Waste Electrical and Electronic Equipment (WEEE)

The conformity assessment followed was according to Annex III of the directive for equipment listed in schedule 1 / article 13 the chosen conformity assessment route Internal control of production

(schedule 10 / Annex V)
- Measured Sound Power Level **95.8 dB(A)**
- Guaranteed Sound Power Level **97 dB(A)**

Standards and technical specifications referred to:

EN60745-1:2009 + A11:2010
EN ISO 10517:2009
EN55014-1:2006 + A1:2009
EN55014-2:1997 + A1:2001 + A2:2008
EN61000-3-2:2006 + A1:2009 + A2:2009
EN61000-3-3:2008

Authorised signatory and technical file holder

Date: 20/12/11

Signature: 

Name / title: Peter Harries / Quality Manager

Titan Power Tools (UK)Ltd. Trade House, Mead Avenue, BA22 8RT



ISSUE DATE: REV3-MAR12

POLE HEDGE TRIMMER 400W TTB427GTM

