

Finnlife® Log cabins

Build guide, parts and plans list

Model: 144771



A.0. Introduction

Those lazy summer afternoons may be beckoning, but don't rush to build your Finnlife Log Cabin. Take the time to understand how it goes together, and you'll enjoy many years of trouble-free pleasure.

No specialist skills are required. Anyone can build a Finnlife log cabin, although some tasks may require more than one pair of hands. Construction times will vary depending on your skills and the number of people who help you.

Of course you don't have to do it yourself. You could hand this booklet to a professional builder, then sit back until he presents you with the keys to your finished cabin.

Whoever does the job, the first stage is to familiarise yourself with these instructions. The trick is to be methodical and to plan ahead.

If you're looking for information on a specific topic, refer to the contents list below or to the glossary.

For a complete parts list and detailed wall and floor plans please see the back pages within this instruction manual.

B.0. Contents

Planning consent and building regulations

Tool list - what you need

Delivery, Checking and storage

Foundations & Preparations

Laying out, checking and sorting

Assembling your door & window frames

Attaching your door & window frame fascia's

Attaching your beading

Installing your floor beams

Laying your DPM (Damp Proof Membrane)

First layer of wall boards

Building up the walls

Finishing the walls

Ridge and roof beams

Roof Boards

Eaves fascia boards

Internal roof battens

Roofing shingles

Gable fascia boards and cover boards

Floorboards

Skirting Board

Air vents

Floor Plans

Exploded Diagram

Parts List

Timber treatments

Wood - a natural material

Health and safety

Customer service

Glossary



The images displayed within this literature are for illustration purpose only and generic for cabin build. They may not appear exactly as your finished product.



Before you commence with construction of your new log cabin please ensure you have a complete set of components. Using the checklist provided at the back of this booklet tick off each part as you remove it from the transit packaging.

Planning consent and building regulations

In most cases you do not need planning permission to build a log cabin in your garden; it is usually also exempt from building regulations. It would be advantageous to contact your local

authority to ensure they are happy for you to proceed before arranging installation.

Tool list - what you need

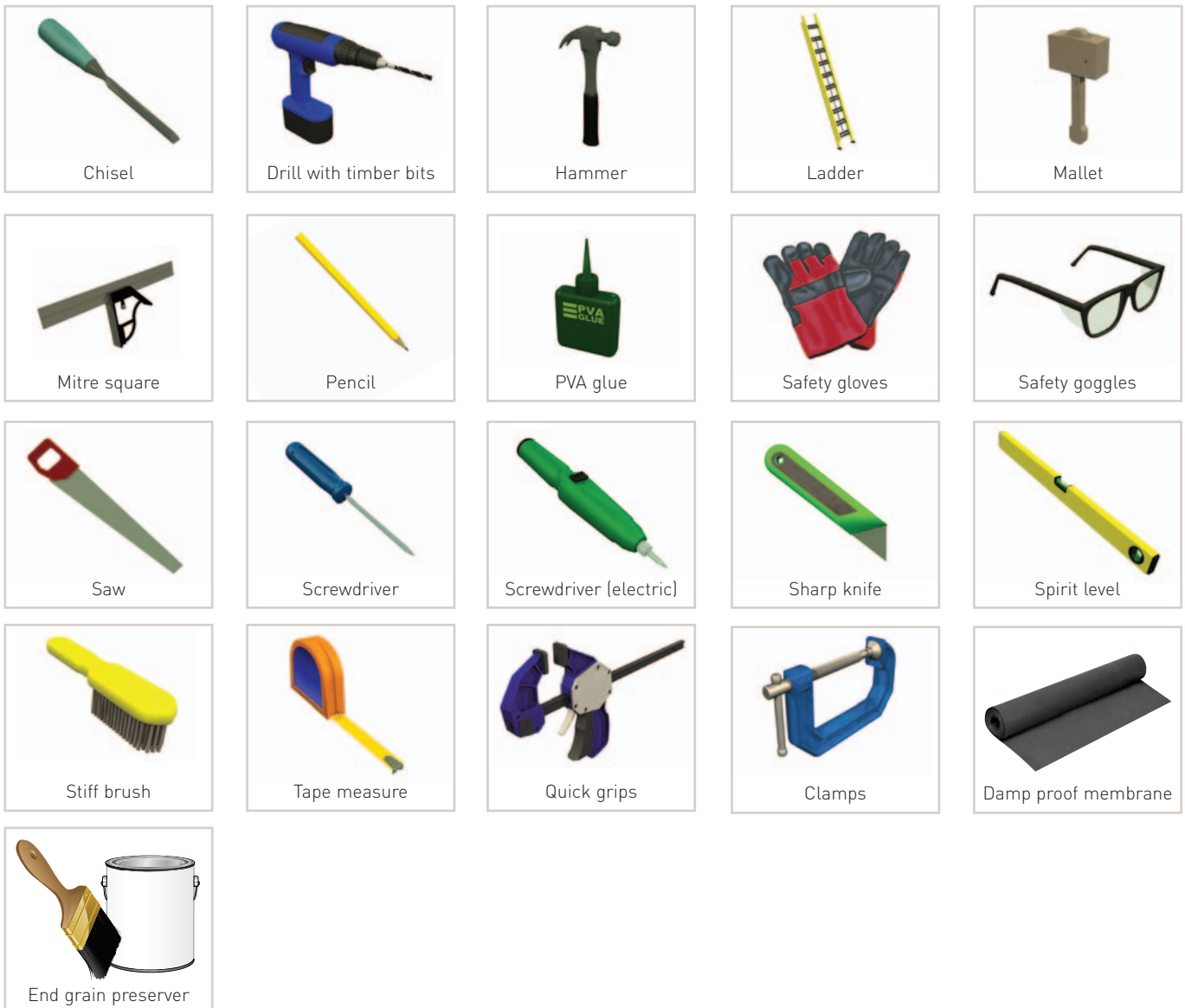

Delivery, checking and storage

Your log cabin comes wrapped in polythene for protection, and strapped to one or more pallets (depending on the model) for ease of transport.

The transit packaging allows for ventilation: it is not waterproof. Please store your wrapped cabin in a dry place, protected from rain and sun. Ensure cabin components are not in contact with the ground.

Foundations and preparation

You can build your log cabin on foundations of concrete or on compressed gravel. Whichever option you choose, a firm and level base is essential. Time spent on the foundations is well invested. For your specific base size please see your floor plan in the model specific manual. An uneven or unstable base will affect the final outcome of the log cabin, doors and windows will NOT function properly, walls may bow and joints may not fit together.

Concrete option:

Remove all organic matter before you start work on the foundations.

Concrete foundations should always be the exact base size stated in the Floor Plan to minimise the amount of water that the base will carry. It is recommended the concrete base be 150mm thick.



Gravel option:

Remove all organic matter before you start work on the foundations.

Foundations should always be laid larger than the footprint of your cabin – 300mm wider in every direction and 150mm thick when using compressed type 1 gravel.

For compressed gravel foundations you should use retaining boards to keep the gravel in place and compressed.



Laying out, checking and sorting

Before you begin to build you should check that you have a complete set of components. Check off each piece against the parts list as you remove it from the transit packaging. In the unlikely event that there is a missing component, or that a component has been damaged in transit, please contact the technical helpline, quoting the cabin reference number displayed on the packing label of the transit packaging.

As you check off components lay them out on the ground around the site of the cabin. Place each component close to where it will be used. Laying out helps you visualise how the cabin goes together, and it means that components are ready to hand when you need them. You can use the Building Plans and Parts List as a guide to what goes where. Be careful not to lay components too close to the cabin footprint. Give yourself adequate room to work in.



Please note:

Do not leave parts directly on wet ground for extended periods, as excessive moisture can damage or cause the timbers to swell.

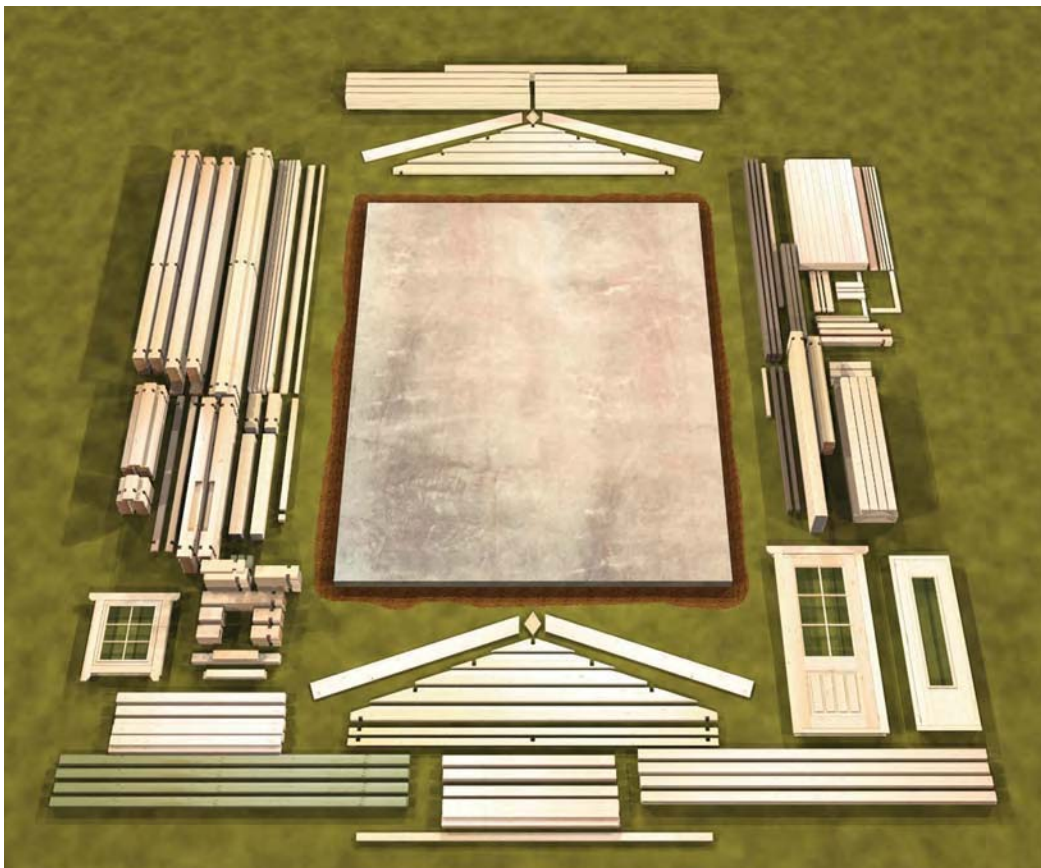

Picture displayed is for illustration purpose only and may not represent your specific model.

Assembling your door frames

Your cabin comes supplied with door frames that do not come pre-assembled. They need to be assembled glued and screwed, since strong PVA adhesive needs time to dry, you should assemble and glue your door frames before you begin building your cabin.

The door frame is constructed of four parts the Door Jambs left & Right, the Header and the Sill. These will need to be constructed before you can continue to build your cabin.

Layout the four sides of the door frame on a clean and level surface so that the hinges are on the upper surface of the door jambs. (Place a protective sheet on the ground if necessary.)

Loosely arrange them to match the finished frame.

*** Please note: The bottom of the door frame (Sill) has a metal threshold.**

Starting with the header, run some glue in to the corner joint. Then slot in the left side door jamb ensuring a tight fit. Using the screws provided secure together. Once tight wipe of any excess glue with a damp cloth. Repeat the process for the right hand door jamb.

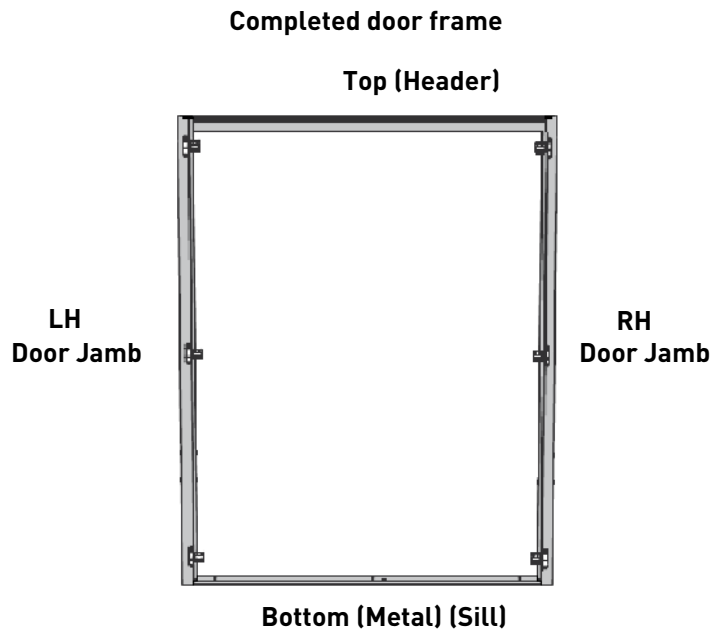

Now you will need to secure the sill (bottom) of the door frame.

You will notice that the seal is constructed out of metal and has turned up corners with holes in. Align these holes to the door jambs ensuring you have positioned them correctly. The sill corners are designed to be positioned on the outside edge of the frame so the fixings are hidden. Using the fixings supplied secure into position.

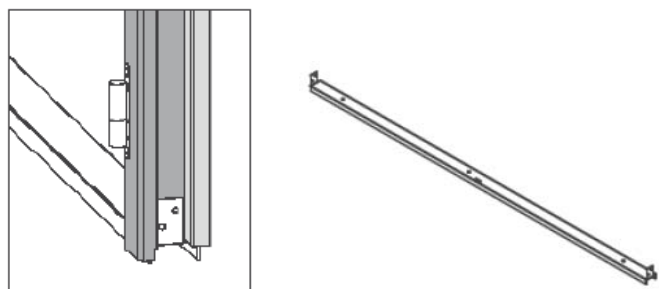

Attaching your door & window frame fascia's

Please note: This section shows double doors, however the same principles apply to single doors & windows.

Once the door frame is complete the next step is to fit the door frame fascias.

Place a protective sheet on the ground so the door frame does not get damaged or marked, Then lay the door frame face down flat on the ground. Please note that the hinges will be laying towards the ground.

Place all of the Fascia's in situ on the door and window frames, once they are aligned secure using the screws provided.

Top Tip:

To ease installation of your door or window frames, do not fully tighten the screws until the door and window frames are in position.

Insert your door or doors in to the door fame to make sure they fit correctly. You can adjust both doors by simply turning the hinges on the frame sides of the doors. Please make sure both doors open and close freely.

Attaching your beading

Align the beading square on each door once they are in the correct location fix to the door using the screws provided.

Now remove both doors from the frame before fitting the frame to the cabin.



Please note: The beadings are supplied with two size screws, long screws for the horizontal beading, and short screws for the vertical beading.

Please ensure that the correct screws are used in the correct location, if wrong screws are used they may damage the glass within the window or door.

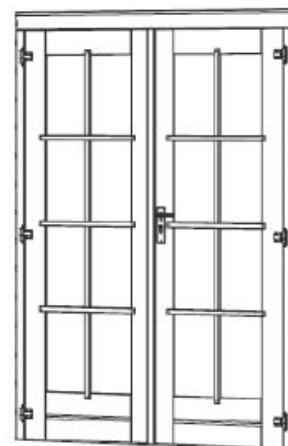
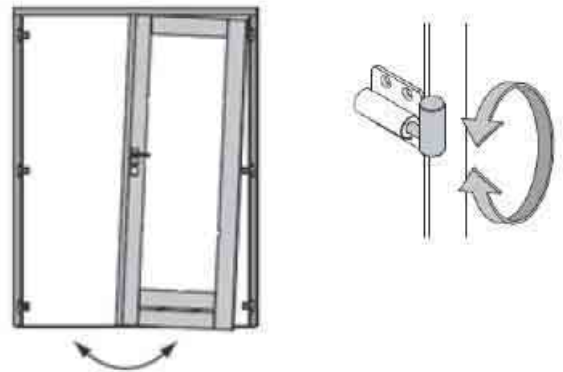
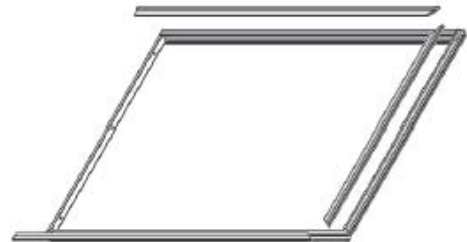
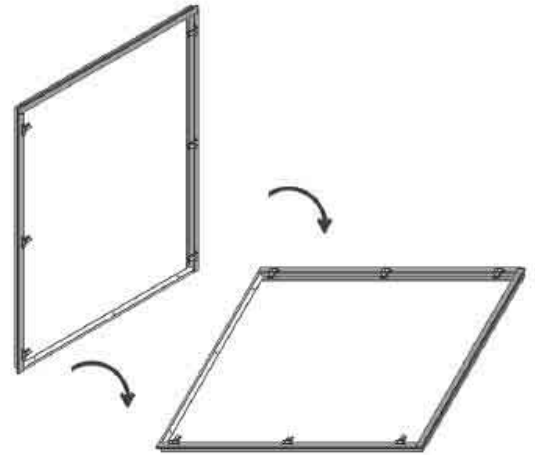

Installing your floor beams

Your finished cabin rests on a series of beams known as floor beams. They provide a solid base and raise the cabin off the ground for ventilation.

To prevent damp rising into your cabin, each floor beam should be covered by two strips of damp-proof membrane. **(Product not supplied)**

You can purchase a sheet of commercial damp-proof membrane and cut into strips as required.

Floor beams are easy to identify. They are impregnated with a long-lasting preservative that makes them appear darker in colour.

Although each beam is pressure treated, any freshly exposed timber or cuts must be treated with an end grain preserver. **(Product not supplied)**

***The layout of floor beams depends on your cabin model; please refer to your Building Plans towards the end of this guide.**

Since all floor beams come in standard 2.4m lengths, you will have to join lengths of floor beams for walls which are in excess of 2.4m.

Ensure you have checked off your components for your foundations, as you will need to cut these parts to the required lengths.

The first stage in creating your floor beams is to form an external ring foundation which the cabin wall logs will rest upon. Refer to your floor plan towards the end of this guide for detail.

There are two different types of connections.

Corner Bracket (A)

These brackets are used to connect the corners only of your external ring foundation.

DO NOT use on the internal floor beams!

Connecting Strips (B)

These connecting strips are to be used to join lengths of floor beams together.

Starting in one corner, join two of your lengths of your floor beams together to form the start of your ring foundation.

Ensure they are flush on the corner and the corners are square.

When using these connection brackets please ensure that you use the fixings supplied and always connect on the internal edges of your foundation layer. see image above.

This way the fixings are hidden on the inside and there are no unsightly brackets exposed on the external foundation layer.

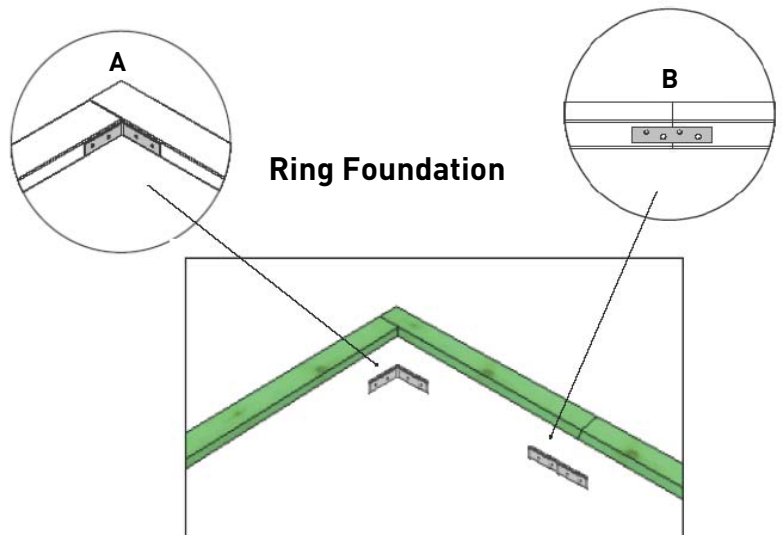

When fixing using brackets and strips, please ensure the screws are fixed on the inner side of the timber.

Installing your floor beams (Continued)

Continue to cut your floor beams and secure together to make the *ring foundation*. To minimize waste we advise you to use the off-cut to create the start of your next row or run.

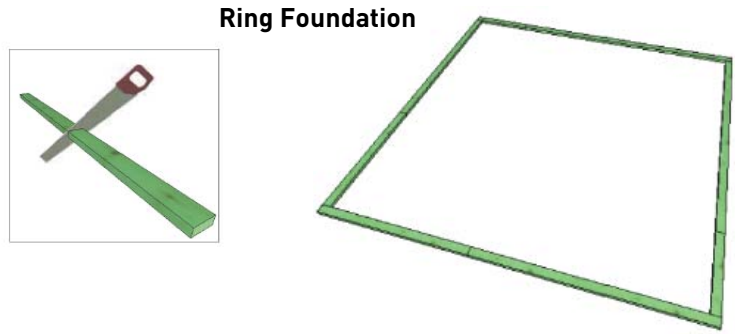

Now insert your remaining floor beams into position within your *ring foundation*. Continue to cut and join these together to make your framework up. Refer to your floor plan for guidance to the position of these beams.

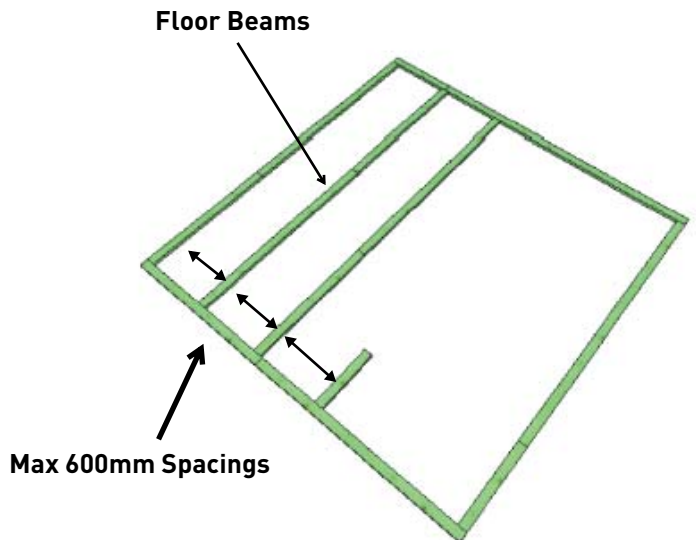

Fix the floor beams to the inner faces of the foundation layer by driving screws in at an angle of about 45° . Use two screws at either end. (Screws not supplied)
When you have fixed all the floor beams, adjust the position of your foundation layer to make sure it sits squarely on your base foundation.

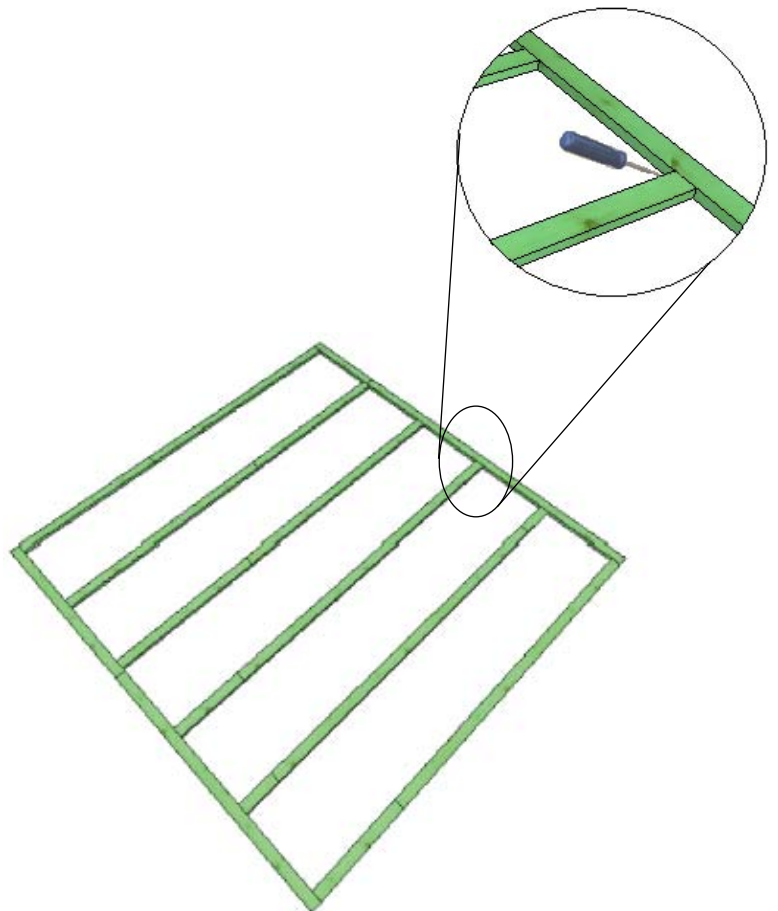

Laying your DPM (Damp Proof Membrane)

Your cabin rests on a set of floor beams, these will be in contact with your foundation base.

We advise that you place a DPM (Damp Proof Membrane) on top of your ring foundation and floor beams to prevent moisture ingress into the cabin walls.

Cut a sheet of DPM into strips roughly 68mm wide for both the ring foundation and floor beams.

Perimeter

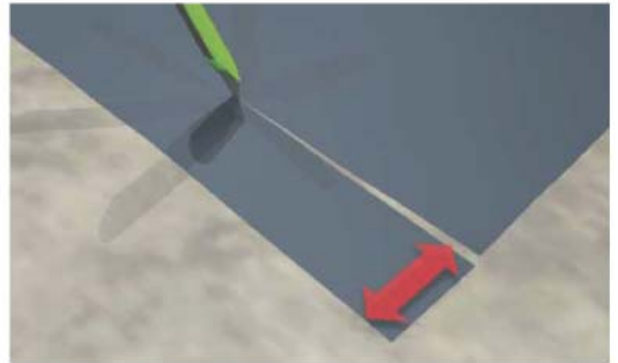
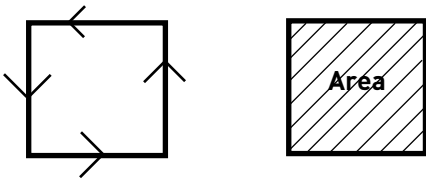

It is critical to fit a DPM according to instructions.

Line your strips of DPM around the perimeter area of your ring foundation.
Position the DPM to leave approx 18mm of exposed area of ring foundation.
You will need to lay 2 layers of DPM around the perimeter area of the ring foundation only.
You will find you have a large amount of excess DPM on the inside edge of the ring foundation.
Do not worry at this stage as the bottom layer will be positioned under your floor boards and the top layer must be turned up and secured to the cabin walls as instructed within this guide.

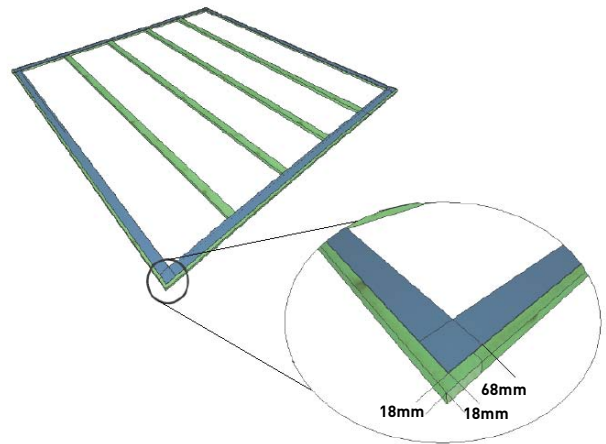

Cut further strips to the width of your central floor beams. Approx 68 mm as these will need to be laid on top of the floor beams.

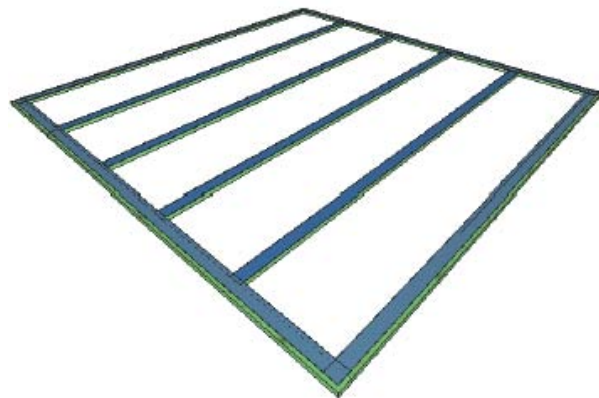

***Please note that when your cabin is fully constructed, a line of sealant must be applied around the base of the cabin walls, between your ring foundation and the bottom of the cabin. This is to prevent moisture from sitting on your ring foundation.**



first layer of wall boards

Wall boards and posts have been machined for a secure fit. Before you use a wall board or post, it's worth running a stiff-bristled brush along the grooves and poking the bristles into the joints to remove any stray sawdust. Sawdust-free joints result in a better fit. Walls are built by inserting wall boards into the posts at right angles to one another.

Individual wall boards are identified by reference to the Parts List and Plans featured towards the end of this guide, we advise you measure them before continuing to construct, so that the correct wall boards are being used in the correct position.

Start with a post and a couple of wall boards. They form the corner structure of the cabin. Position the post over the corner of the ring foundation ensuring the post has a 10mm overhang beyond the ring foundation. See image. Slot in a couple of wall boards into the post at right angles ensuring they are pushed in firmly.

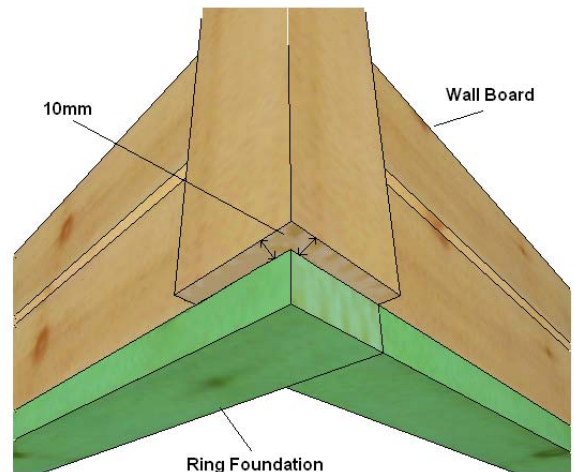

Ensure the post is in the vertical position and the wall boards are level. (Use a spirit level to check this.)

Secure corner bracket to the post and first two wall boards approximately 65mm up from the bottom edge and secure using the screws provided.

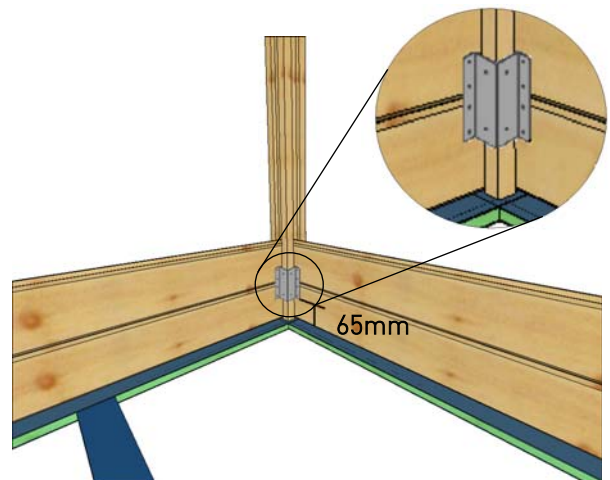

Note.
There are different types of corner brackets, please refer to parts list for details.

Repeat the process for the remaining walls and have in place all your posts.

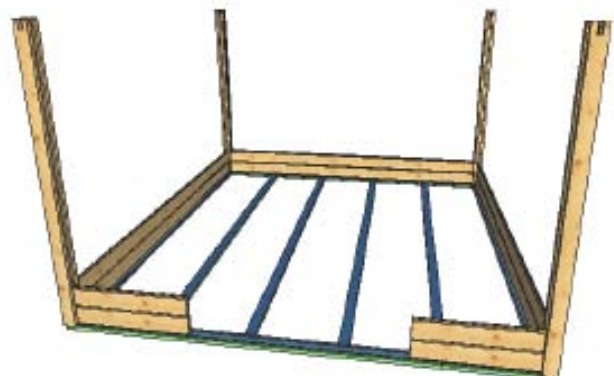

first layer of wall boards (Continued)

Once you have attached all your corner brackets you will need to insert your door frames.

Door and frames do not come pre-assembled. If you have not yet put your door frame together, refer to Assembling your door frame Section earlier for assembly details. Installing the assembled unit into your cabin is one job that could benefit from a second pair of hands. All doors open outwards. Make sure you install them in the correct way.



Please note: We advise you to only position the door frame without the doors hung, as excess weight and pressure on the frame will cause the frame to twist.

Please note: There may be a gap above the doors which will close up over time. (approx 30 - 50mm) The gap is there to allow for shrinkage within the building. Please do not block the opening as this may prevent the cabin from settling naturally.

Install door frames after you have laid TWO layers of short wall boards on the front elevation of your cabin.

The assembled door frames have wide grooves cut into the architraves. Slide the frames vertically into the gaps in the walls so that the ends of the wall boards fit into the grooves in the architraves. Tap the door frames lightly from above to ensure they go all the way to the bottom, but be careful not to exert too much pressure or to twist or distort the frames. Check that the hinges are facing the outside.

Check that the door frames are square and vertical before you continue to build up the cabin walls. A misaligned door will not open properly.

If your doors are misaligned you may have to remove and replace once more, ensuring a tight secure fit.

Once the door frame is in position, you will need to secure using the door frame brackets. Locate these brackets and position these approx 65mm up on each of the door jambs either side and secure using the screws provided.

To check your door frame is sitting square, use a tape measure to measure the diagonals - they should match each other.

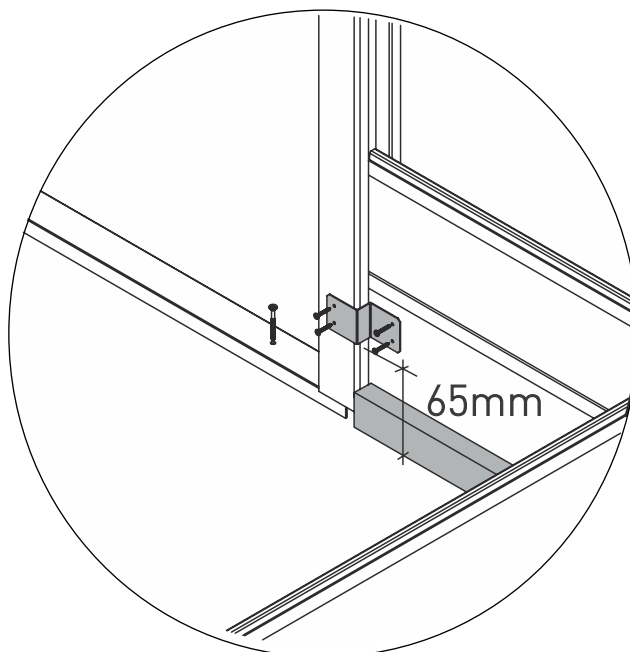
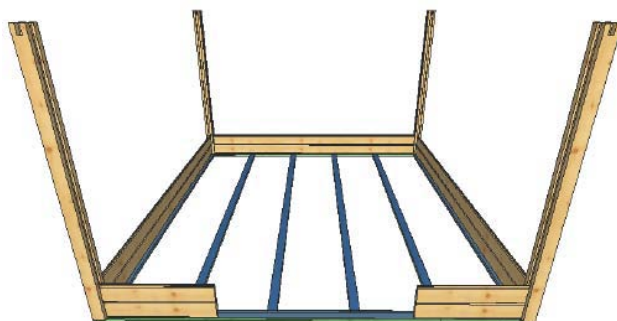

Building up the walls

Once you have secured the door frame and posts into the correct position, you will need to check that the cabin is square. Using a tape measure, measure across the diagonals and adjust to suit, ensuring the cabin walls are level and post are vertical.

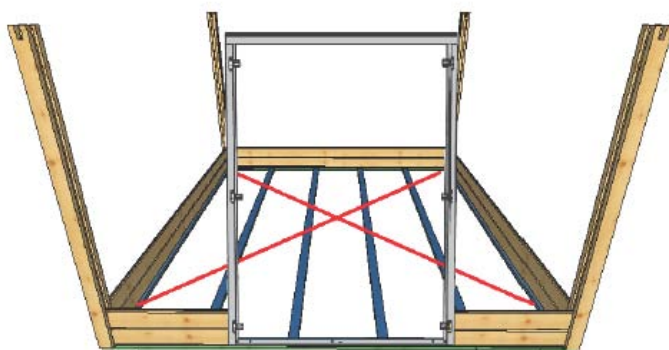
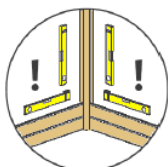

Once the cabin is in the correct position you can continue to insert more additional wall boards.

Continue building until you reach your 6th layer whilst continually checking the cabin to be square and level.

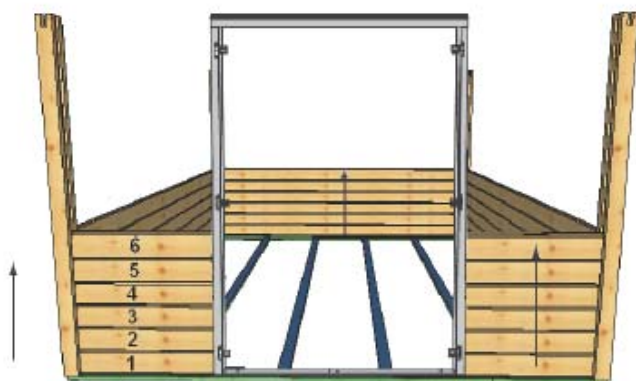

Once you have reached your 6th layer you will need to install an additional internal corner bracket. Position this central to the 6th wall board, securing using the screws provided. Repeat the process for the other three posts.

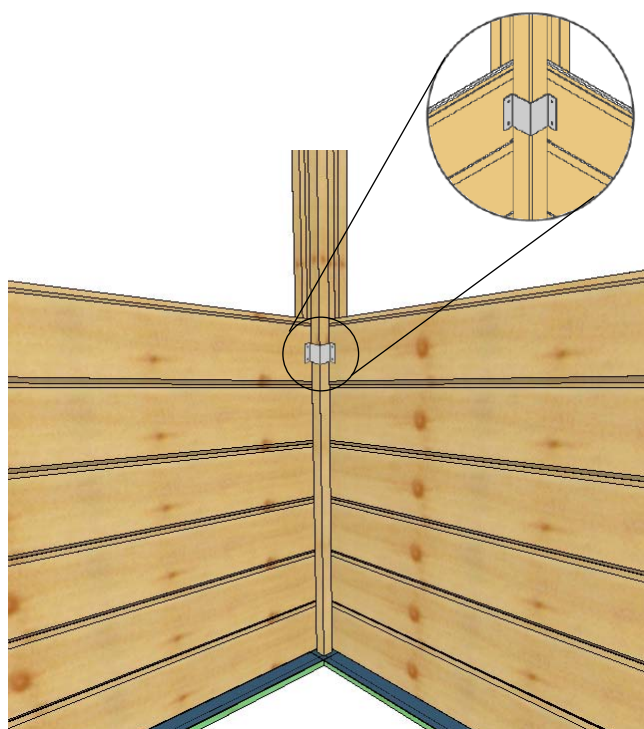

Building up the walls (continued)

Continue to insert further wall boards ensuring you install your windows are at the correct height. Please ensure that your windows are installed the correct way round and open correctly before further construction.

Refer to you Building Plans and Parts List for guidance for height and positioning.

Once the windows are correctly installed continue building up the walls.



Check you parts and plans list for height & positioning of window.

Finishing the walls

Completing the following steps will require an additional pair of hand's, as these parts can be very large and heavy. And require accurate positioning as machined notches can be easily damaged if handled incorrectly.

Wall Board Top

By now the structure is starting to resemble a cabin and you will need to install the top most wall board and gable boards.

The top wall board is needed to help secure the top ends of the posts and maintain a more firm structure to work on.

The Gable board is needed to create a structure for your roof beams and roof boards to rest upon.

Install the top most wall board on both sides of your cabin, ensuring the wall board sits over the post securely.

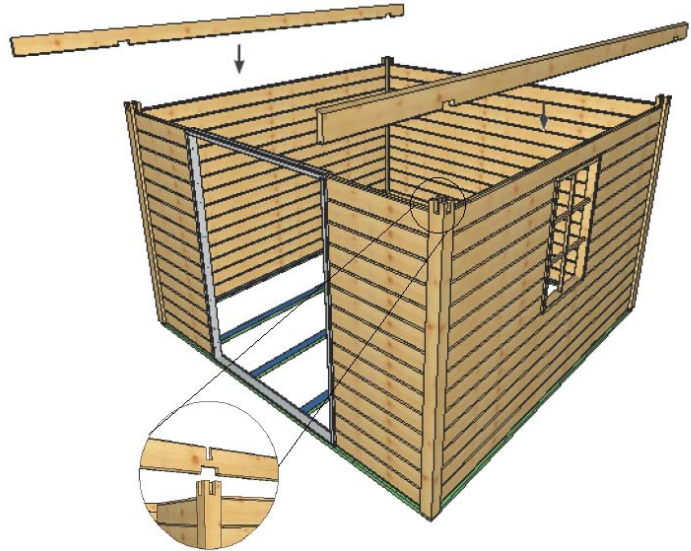

Gable Board

Position the gable triangle over the top wall board and post allowing it to sit into position, the post has been designed to allow the cabin to settle and expansion allowing the gable triangle to move with the walls.

Completing the following steps will require an additional pair of hand's, as these parts can be very large and heavy. And require accurate positioning as machined notches can be easily damaged if handled incorrectly.

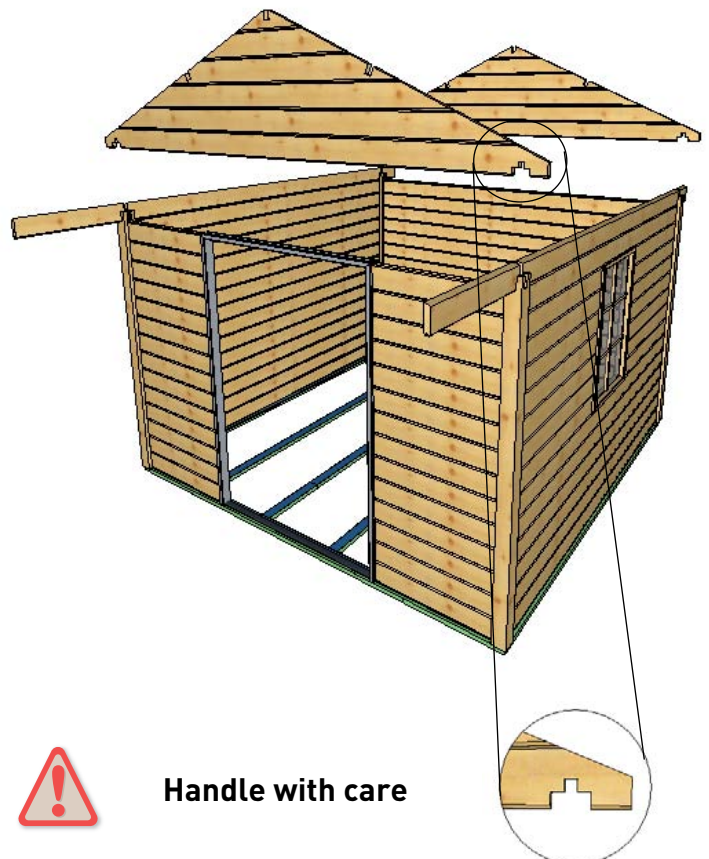

Ridge and roof beams

Building up the gable ends reveals a succession of slots for the roof beams. As each slot appears, tap in a roof beam. Make sure that the top of each roof beam lies flush with the slope of the gable. Nail through into the gable boards to secure.

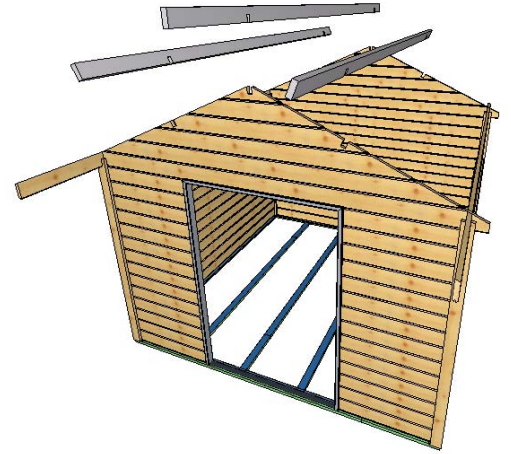
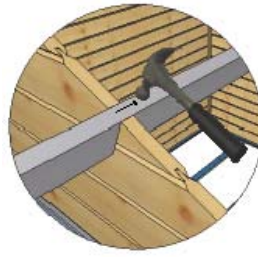

Tap the ridge beam into place at the apex of the gable triangle. Secure by nailing into the uppermost gable board.

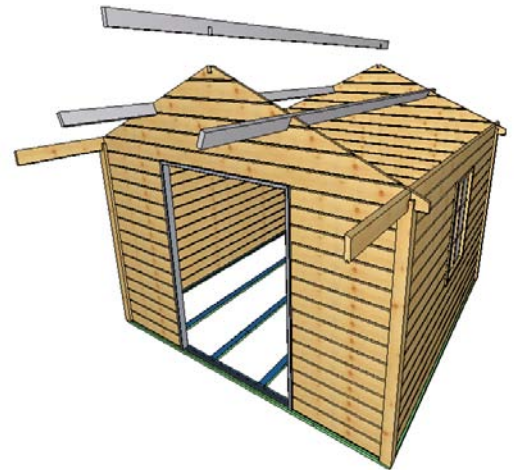

Installing Upperwall Brackets

Once the ridge beams are secured you will need to install your final set of adjustable corner brackets.

Position the bracket at the top of the post and secure to the wall boards.

Finally insert a screw and washer into the adjustable bracket in to the post, secure the screw approx 20mm down from the top of the elongated hole in the bracket.

Do not over tighten the screw, ensure the washer is free to move.

The elongated hole is designed to allow for movement within the wall boards.

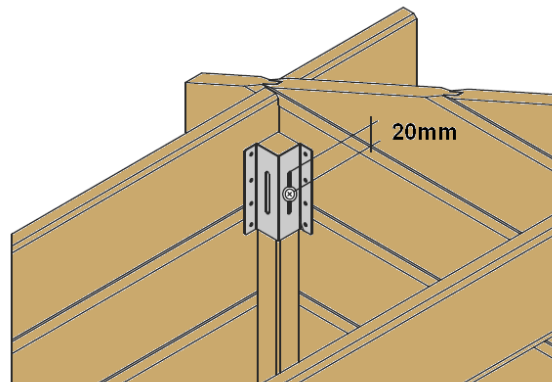

Roof boards

When laying the roof boards, you will need to temporarily tack an eaves fascia board to the ridge beam as a guide batten, and use it to make sure that all roof boards terminate in a flush ridge line.

Mark the centre line on the front and rear faces of the ridge beam.

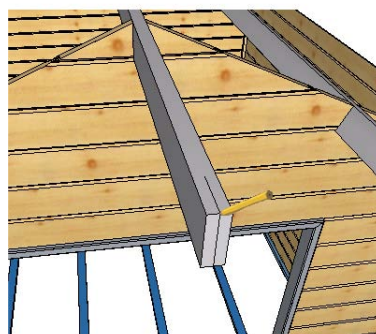

Tack an eaves fascia board temporarily with nails to the ridge beam so that one edge is flush with the marked centre line.



Do not hammer the eaves fascia board in all the way as you will have to remove it later on.



When constructing the cabin during the summer periods, we advise to leave small gaps between the roof boards to allow expansion for the boards during the winter months. Where as building during the winter months we would advise knocking the boards together, to reduce any gap appearing during the hot and dry periods.!!

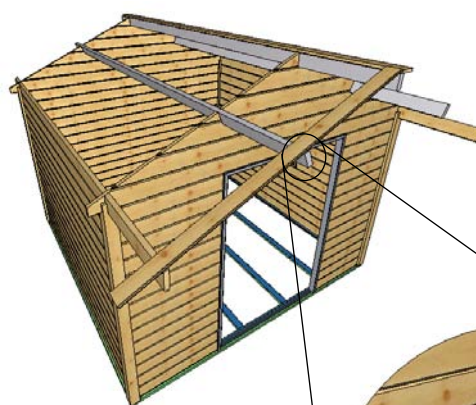

Begin nailing roof boards on one side of the roof, starting from the front. The leading edge of the first roof board should be set 5mm from the ends of the ridge and roof beams. The uppermost end of the roof board should be flush with the temporary ridge-beam guide batten. Nail each roof board to the ridge beam and every roof beam, driving 2 nails per board - per joint in at right angles to the roof slope.

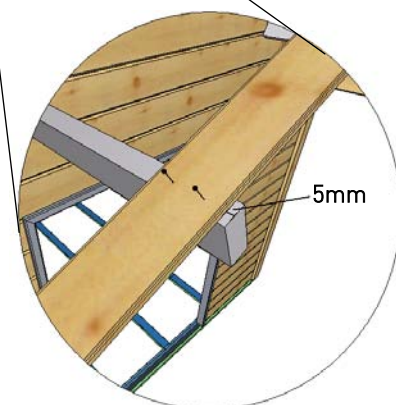

Roof Boards (Continued)

Work through, board-by-board, to the rear gable. Make sure that the eaves line created by the lower edges of the roof boards is as straight as possible.



The last roof board may project beyond the ends of the ridge & roof beams. Tack it down lightly and mark on the underside where it meets the ends of the ridge and roof beams.

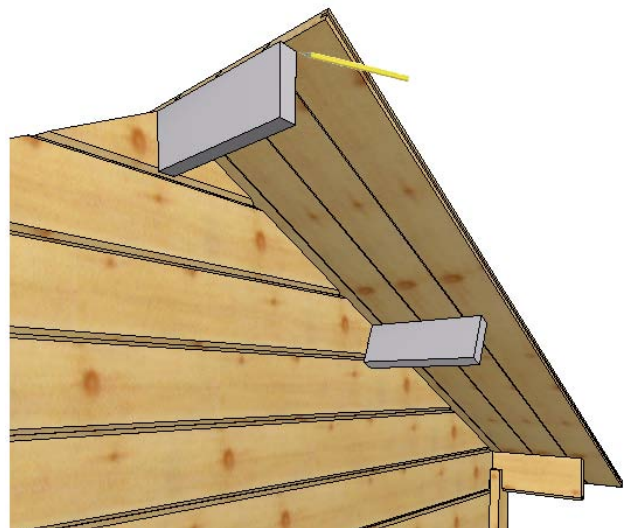

Remove the final roof board and saw it lengthways 5mm inside the marked line. Lay it back on the roof and nail down.



Allowing a 5mm gap between the last board and fascia will enable the timber to expand & contract.

Remove the temporary guide batten (Eaves Fascia) from the ridge beam, then repeat stages for the other side of the roof.

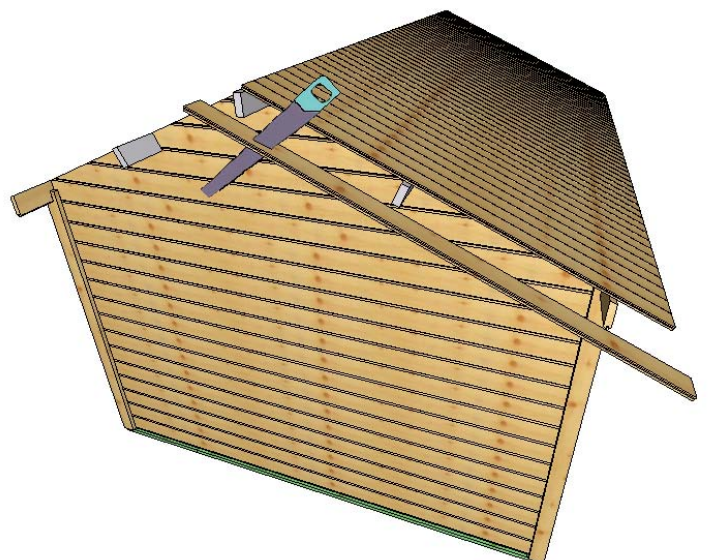

Eaves fascia boards

Check that the eaves line created by the roof boards is reasonably straight. If necessary, use a saw to trim it flush.

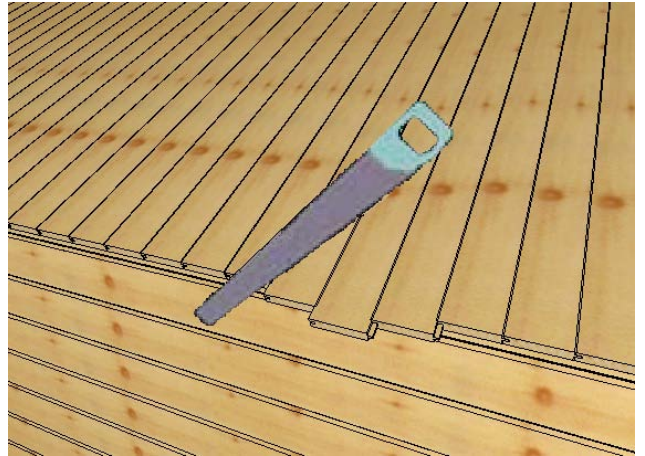

Attach the eaves fascia boards perpendicular to the roof boards, and flush with their upper surface. You may find your eaves fascia supplied in various length depending on your model. (Refer to parts list)
Secure the eaves fascia board to each side of the cabin into the ends of the roof boards.

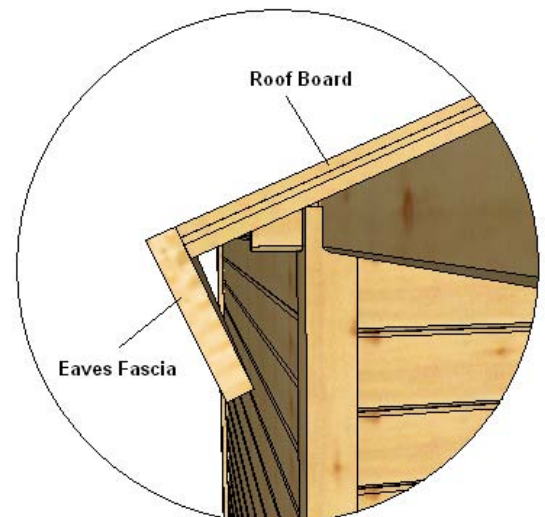

Internal roof battens



Please note:

Roof battens and skirting look very alike, please ensure you are using the correct items, by referring to the parts list.

The internal roof batten is fitted to cover the gap between the wall board and the roof board.

Locate your internal roof batten and position up against the internal edge of your roof boards and the lower edge of your wall. Refer to Image.

Secure the internal roof batten to the roof boards using the fixings provided. Take care when fixing into position ensuring you do not protrude through the roof board.

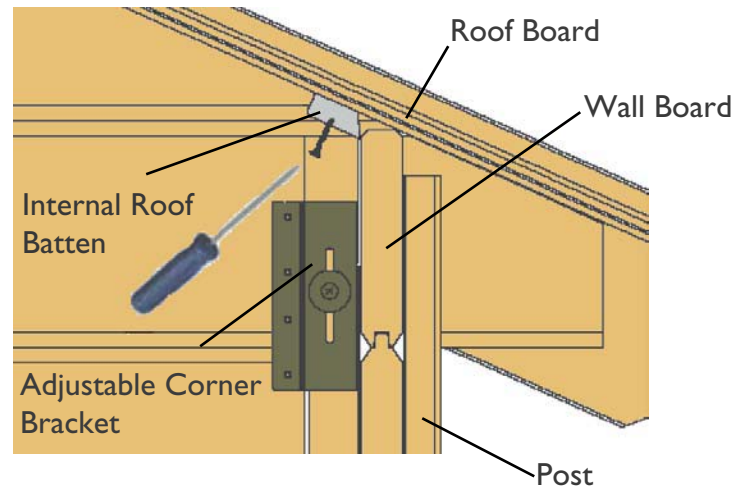

Roofing shingles

Roofing shingles are rectangular. The lower half is cut in two places to give a decorative finish which gives the appearance of individual shingles or tabs once laid. The upper half is coated with bitumen. With the exception of the first row, all shingles are laid with the decorative flaps at the bottom. Lay roof shingles when the temperature is above 5°C. We recommend that you use a bitumen shingle adhesive (NOT SUPPLIED) on the underneath of the tiles. This would be an extra measure to ensure longevity of the shingle life. Proceed with caution when working on the roof: for your own safety, and to avoid damaging the shingles. The roof is not designed to take the weight of a person. Always use a ladder which is secure, and on level ground. Be careful not to let sharp tools damage the roofing materials or to let tools or materials fall on to people below.

Please note that for illustration purpose the shingles shown are green, however the colour of the shingle supplied within your cabin are model specific and may vary in colour.

The quantities of shingles included with your log cabin have been tested to ensure that you have enough coverage for the whole roof. Here are some tips to help ensure you get the maximum coverage from the roofing shingles supplied.

*When counting shingles please note that 21 sheets are supplied with each pack. (See parts list for details)

*Each new row should be laid so that the decorative edge of the shingle finishes just above (2-3mm) of the top of the slit in the tabs of the shingle below.

*Any off-cuts should be used to either start a new row or end a row where possible.

*Many un-used off-cuts may also be suitable for cutting into ridge shingles. (Refer to later section)

Remove all debris and stray sawdust from the roof. Drive home any protruding nail heads to leave a flat and flush surface.



Do not attempt to fit roof shingles at temperatures less than 5°C.

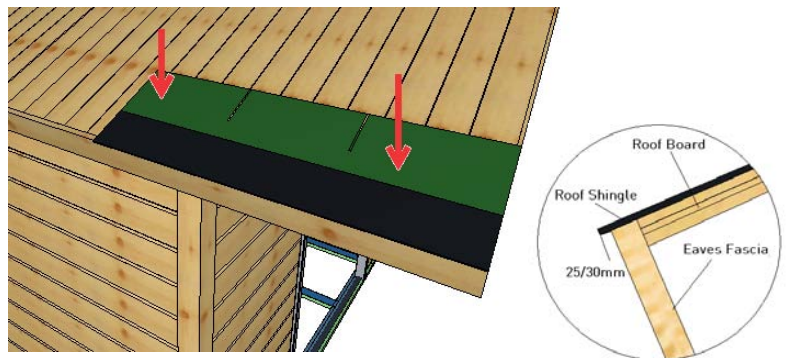

Lay the first row of shingles with the green/black face uppermost and the green flaps at the top. Place the first shingle so that one side aligns with the right-hand edge of the roof and the black bitumen overhangs the eaves fascia board. Ensure that the edge of the black bitumen extends about 25/30mm out from the edge of the eaves fascia board. The 25/30mm overhang is known as the 'water drop edge'.



Please note if you intend to use a guttering system with your cabin, please read and understand your guttering instructions before proceeding with the shingling process.

Secure the shingle with four clout nails driven through the bitumen patches on the shingle into the roof boards. Complete the row by laying more shingles edge-to-edge until the entire length of the eaves is covered. Trim the excess from the left-hand end of the roof. Retain cut pieces for later use.

Begin the second row from the left-hand end. Lay this row (and all subsequent rows) with the green/black face uppermost and the green flaps at the bottom.

Align the second row of shingles so that the lower edge of the green flaps are just proud of the roof edge. Secure with four clout nails driven through the lower green part. Locate these nails just below the line that separates black bitumen from decorative green. Properly located nails will be obscured by subsequent layers of shingles.

Trim the last shingle to fit. Retain cut pieces for later use.

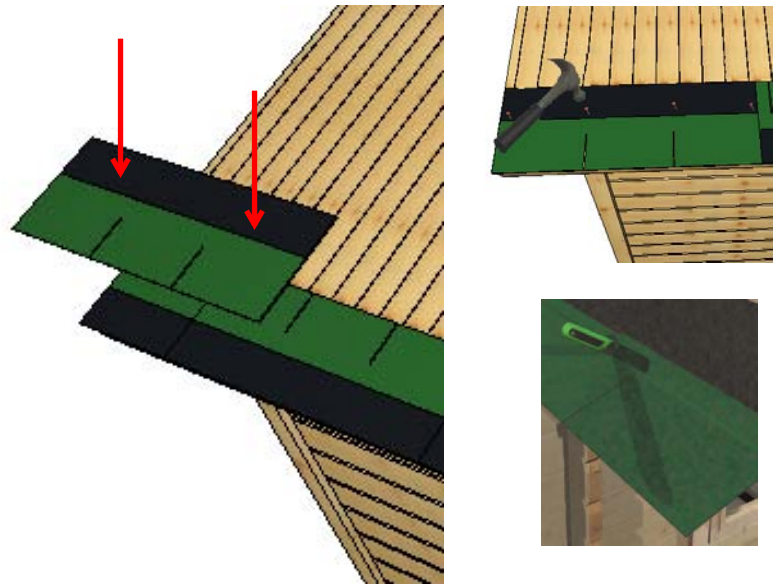

Lay the first shingle in row three so that the mid-point of the left-hand flap aligns with the edge of the roof. Adjust its height until the tips of the decorative flaps align above with the tops of the slits between the flaps in the row below.

Nail down shingle as directed in the previous stage.

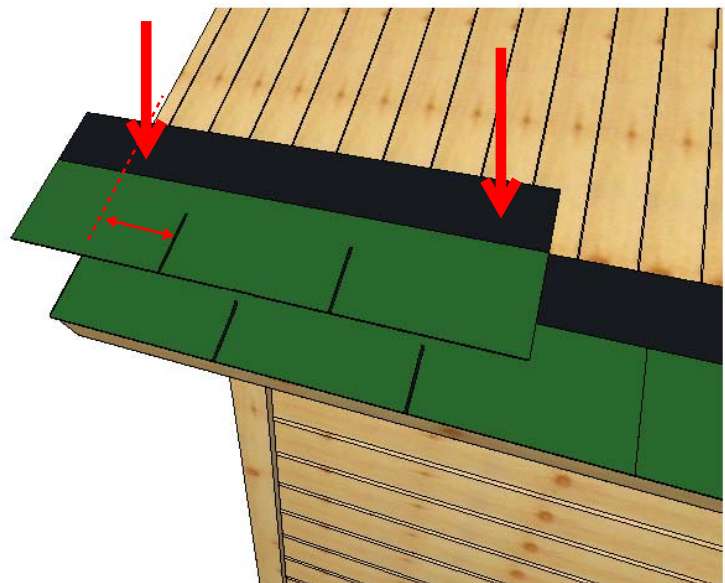

From now on each row has to be parallel with the row below to create an even pattern. Start every row from the left-hand end of the roof. In each case the first shingle in the row must be offset to the left by half a flap, i.e. by one sixth of its total length. That means that the centres of the flaps of the current row will align with the gaps between the flaps in the row below.

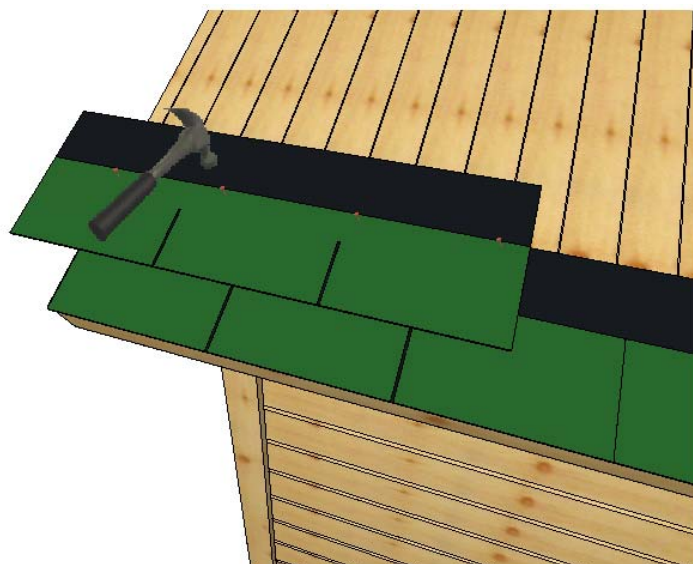

Continue laying shingle sheets from left to right, edge-to-edge, to complete a full row. Trim the excess from both ends and retain cut pieces for later use.

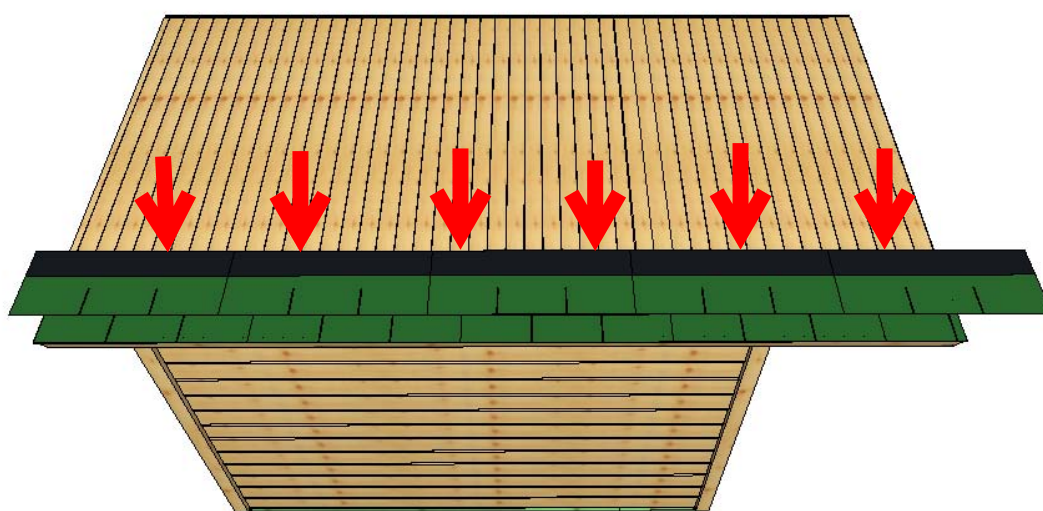

Continue laying rows of shingles from left to right, giving each row an extra half-flap offset to the left. Where possible, use the trimmed pieces you have already saved as the first or last shingles in the row.

When you reach the final row, the upper edge of the shingles will extend beyond the roof ridge. Bend the excess over the ridge and nail it down.

Repeat the process for the opposite side.

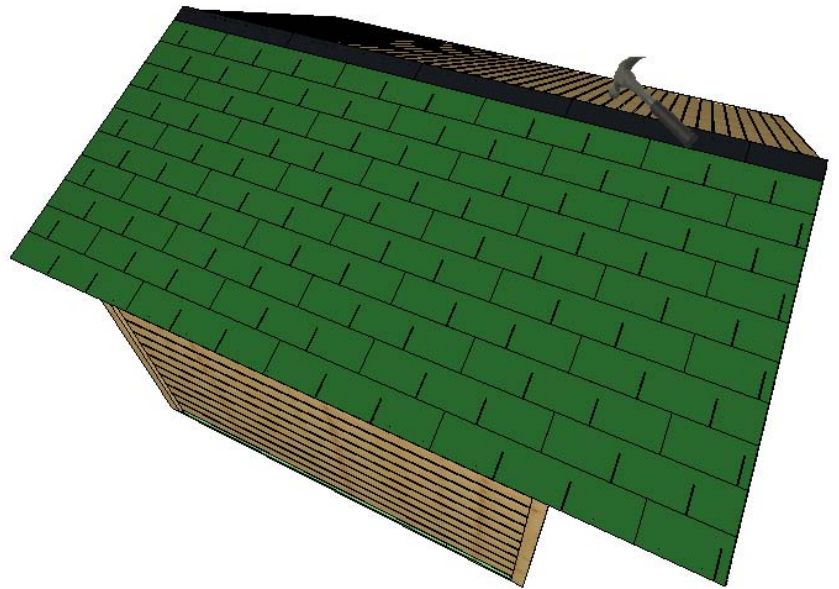

Ridge Caps

Cut several roof shingles into thirds to create ridge shingles. Cut them by extending the slits between the flaps right through the bitumen layer. You can do the same with any trimmed pieces left over from lower rows.

To complete each ridge shingle, you should taper the half containing the black bitumen. Start the taper at the point where the original slit ended. Finish it at the furthest edge of the black bitumen. Take the taper in about 10mm at either side of the bitumen.

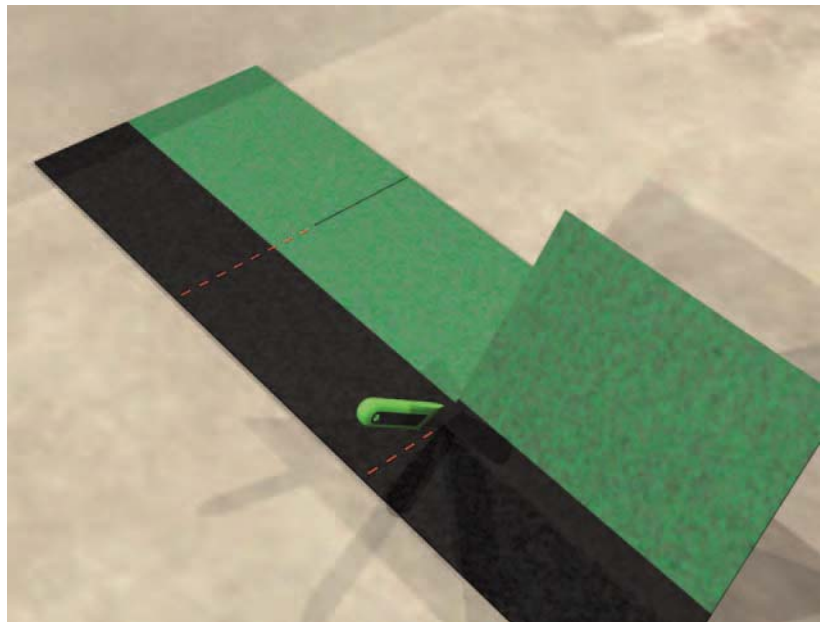

Lay ridge shingles carefully over the ridge without creasing. Begin from the front of the cabin by laying a ridge shingle evenly across the roof ridge so that the tip of the green edge is flush with the leading edge of the roof boards. Secure by driving two clout nails through the black bitumen on either side of the roof ridge.

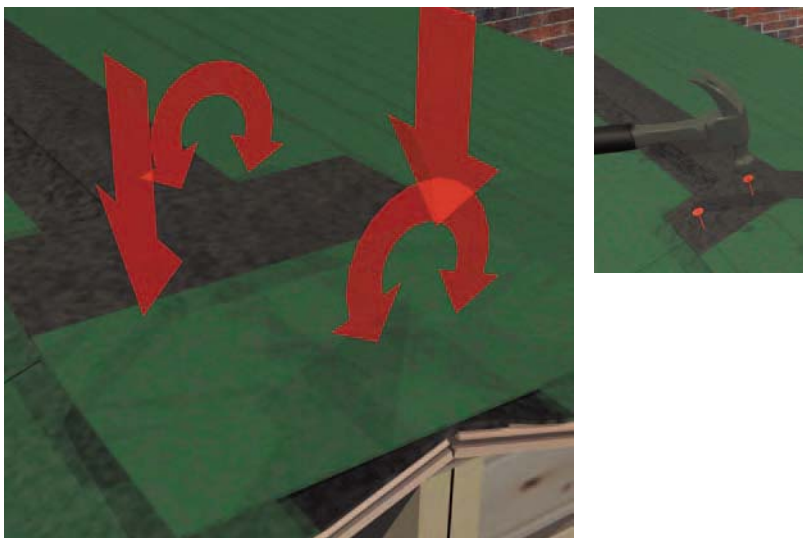

Lay the second and subsequent ridge shingles so that the green half completely covers the bitumen of the preceding shingle. In each case, drive clout nails through the black bitumen to secure.

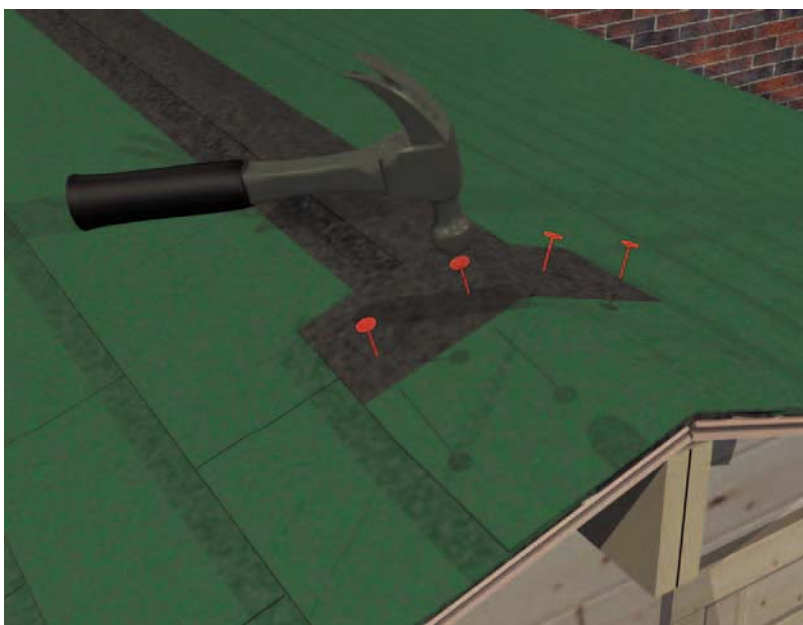

You will have laid the last ridge shingle when there is no black bitumen showing after you have trimmed it flush with the rear gable. Nail it to secure.

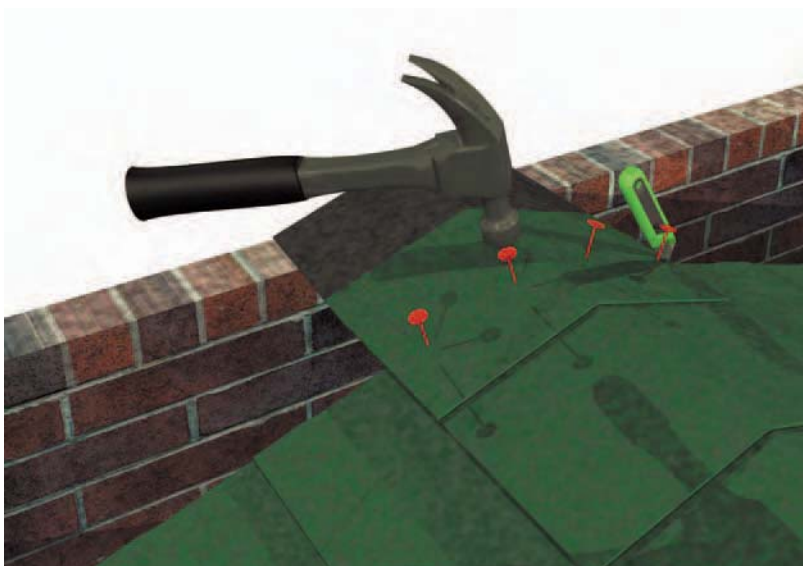

Gable fascia boards and cover boards

Pencil in the vertical centre line on the front end of the ridge beam.



Align gable fascia boards so that the cross-cut angled ends are flush with the vertical pencil mark on the ridge beam and the upper edges of the boards are flush with the upper surface of the shingles. Attach the fascia boards by nailing to the ends of the ridge and roof beams using the provided nails.

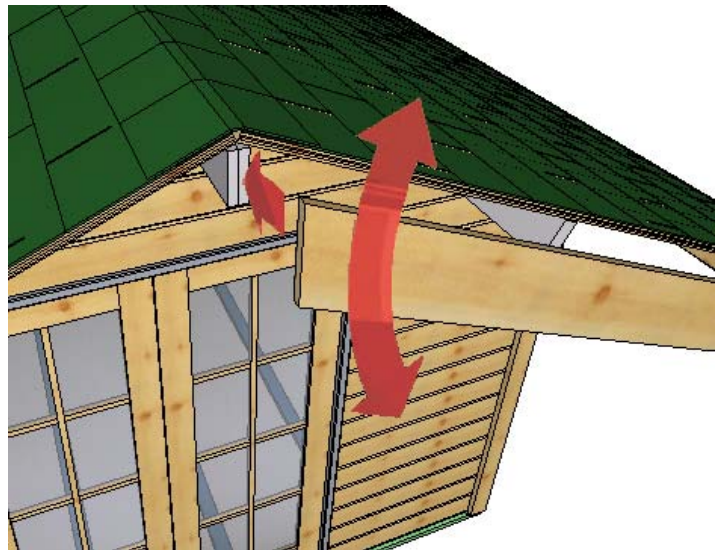

Repeat the process for the opposite end.



Place gable fascia cover boards if supplied with your cabin over the upper edge of the gable fascia. Lay them perpendicular to the gable fascia so that their front edge is flush with the front face of the fascia. Fix them by nailing through to the gable fascia.

Repeat for the other gable end.

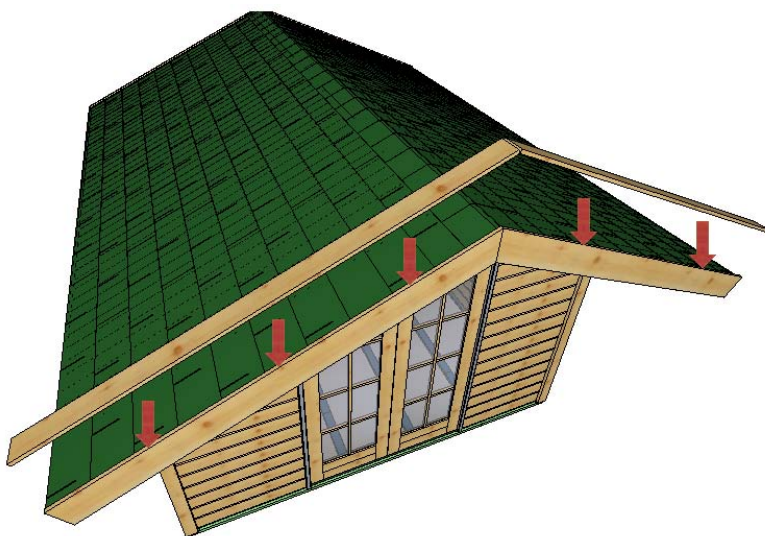

Nail a gable diamond at each end of your cabin so that it covers the join between the two gable fascia boards.

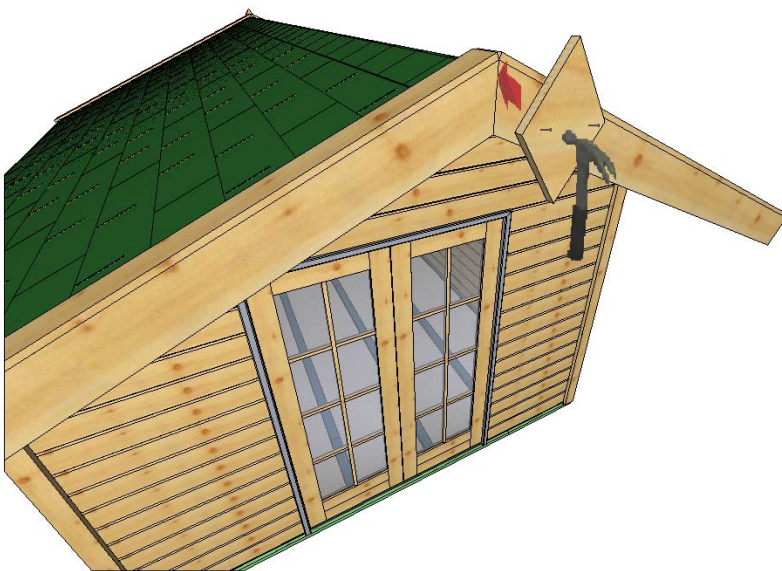

Floor Boards



Please note:

When constructing the cabin during the summer periods, we advise to leave a slight small gaps between the floor boards to allow expansion of the boards during the winter months. Where as during the winter months we would advise knocking the boards together to reduce any gaps appearing during the hot and dry periods.

If you are going to treat the floorboards in some way, cover them with cardboard or paper until the time comes to apply the treatment.

Untreated floorboards get dirty easily. Lay the floorboards last . That way you minimize the chance of getting them dirty when working on other tasks.

Your cabin will be supplied with floor boards which have tongue & grooves on four sides.

Firstly check that you have the correct amount of floorboards. (Refer to your parts list for details)

Before you lay your first board you will need to adjust the DPM (Damp Proof Membrane) layers you laid previously at the start of the build.

You will have laid two layers of DPM, the floorboards will need to be positioned only on the bottom layer of DPM. (See illustration)

The top layer of DPM will need to be lifted up and secured to the wall. You can temporarily tack the top layer to the wall - Keeping it clear of the floorboards.

You will need to cut in the corners of the top layer to allow you to turn the DPM up.

The first floorboard which you lay within your cabin should be positioned 10mm away from the cabin walls.

You will also need to cutout the floorboard to fit around the post in the corners to allow for any expansion.

Floorboard

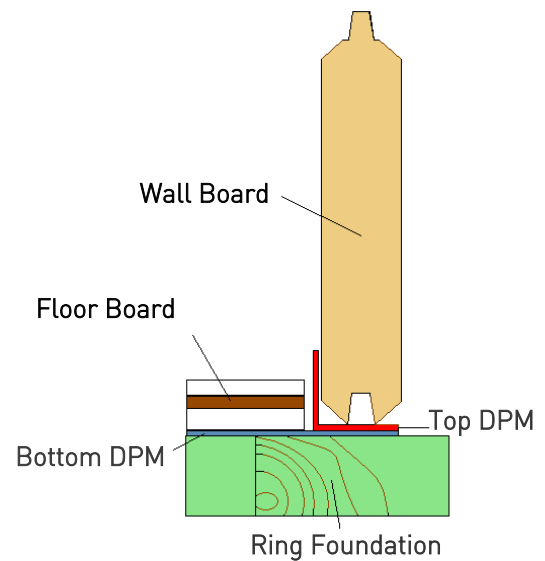
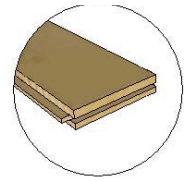

Do Not cut through the bottom layer of DPM!

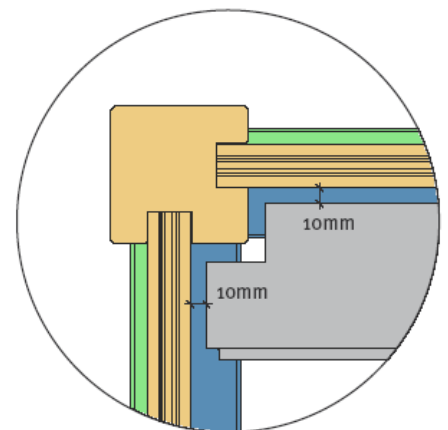

Starting at the front of the cabin, insert your first floorboard into position pushing it up to the internal edge of the post.

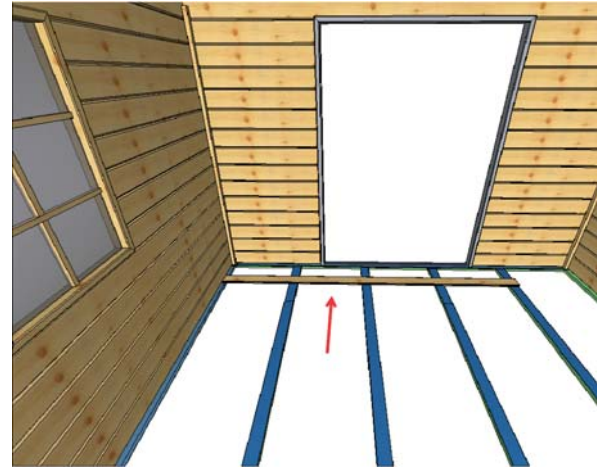

Ensure you allow a 10mm expansion gap at the edge & end of the board mark a line allowing 10mm clearance area around the post.

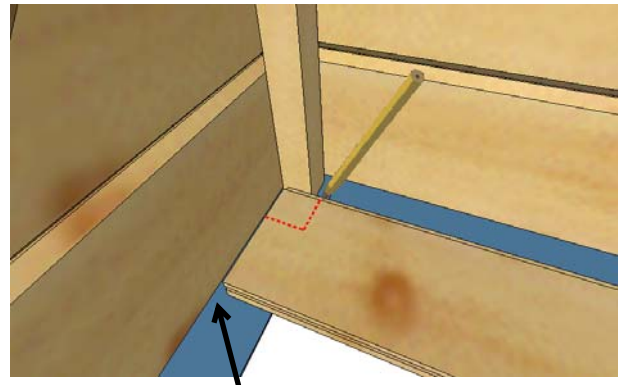

10mm Expansion Gap

Lift up the top layer of DPM and fold it up the wall as shown earlier.
Lay the first floor board into position on top of the bottom layer of DPM.
Once you are happy with the position of the board, secure it to the floor beams.

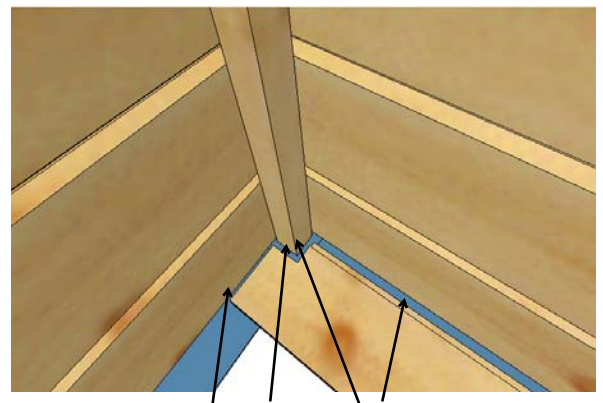

10mm Expansion Gap

Secure using 2 nails per floor beam.
You may find that the length of floor board overhangs the floor beam, do not worry as the next floor board will interlock with this board producing a secure and stable surface.

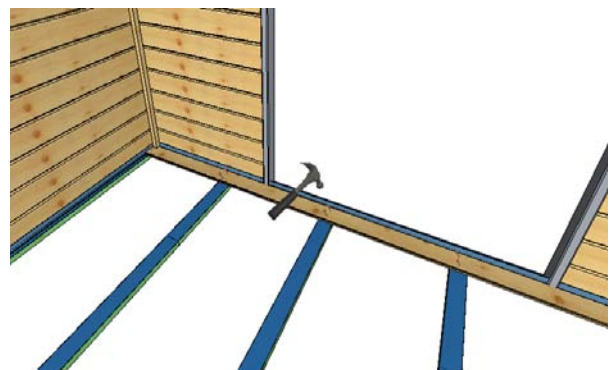

Locate your next floorboard as you may need to complete the first row,
Position the board so they are butted up together opposite edge to opposite edge. Tongue to tongue or groove to groove see image.

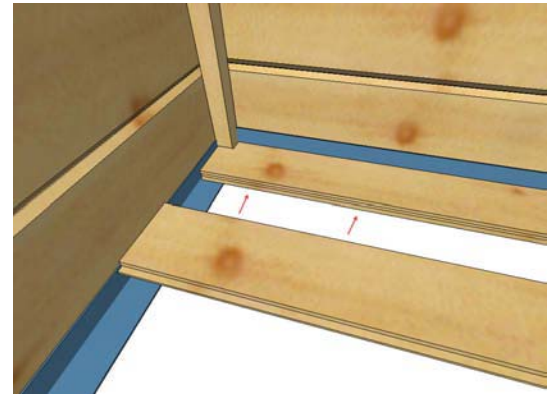

Boards may be orientated differently than shown.
Check which edges have tongues and grooves.

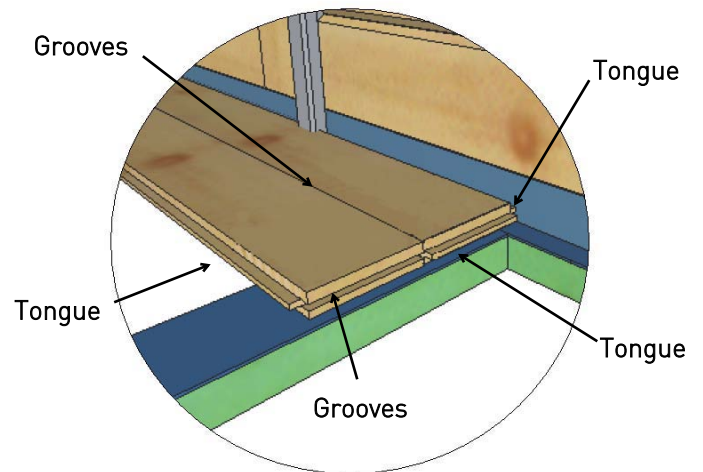

Slide the board so that it is in line with the first floorboard laid, and position so that it has a 10mm clearance from the edge of the wall for expansion.

Use a pencil to mark a line where the first floor board ends and cut.

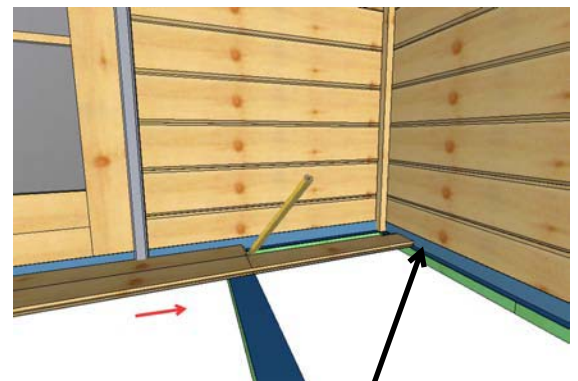

10mm Expansion Gap

With the board cut, rotate the floor board 180 degrees and slot into position, pushing up to the post.
The remaining piece of floor board will be the start of your next row.



Ensure you allow a 10mm expansion gap at the end of the board, mark a line allowing a 10mm clearance area around the post.



Slot your board into position ensuring you have allowed enough clearance for expansion. Before securing into position, lift the top layer of DPM only to allow you to fix down to the floor beam.

Secure using 2 nails per floor beam.



Repeat the process until the Penultimate row of floor boards.

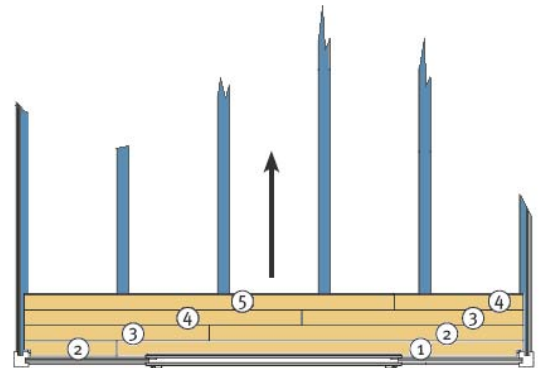

Cut your final row of boards to the width of your cabin.

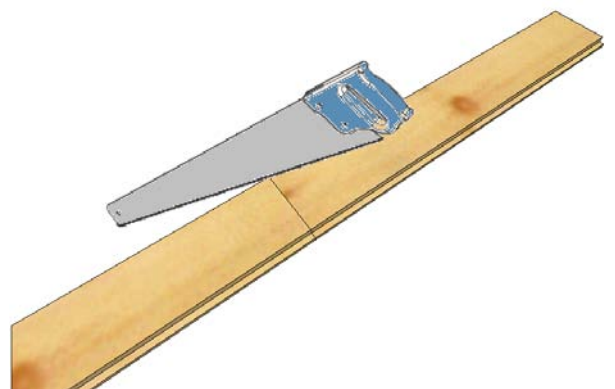

Measure from the edge of the penultimate floor board to the wall and reduce the measurement by 10mm for expansion.

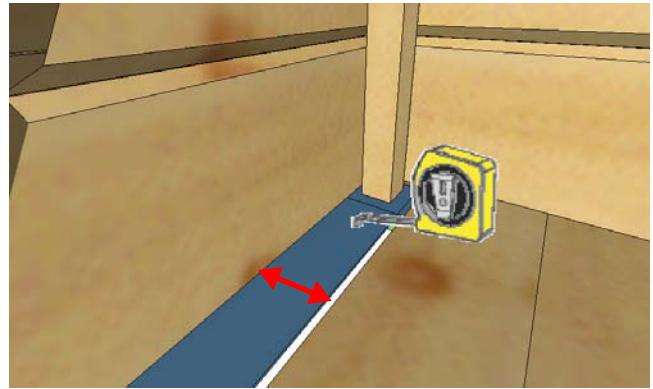

Transfer your measurement to the final board, draw a line on the correct edge down the length of the board and cut.

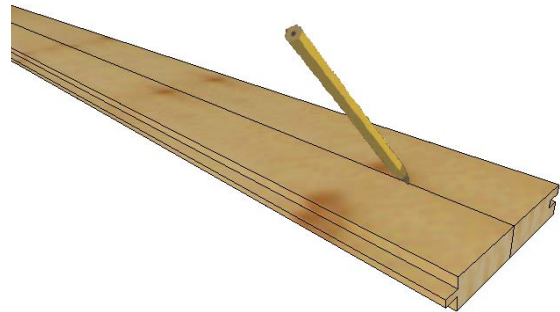

Position your final cut board and push up to the post. Mark the position of the post and allow for a 10mm expansion gap and cut.

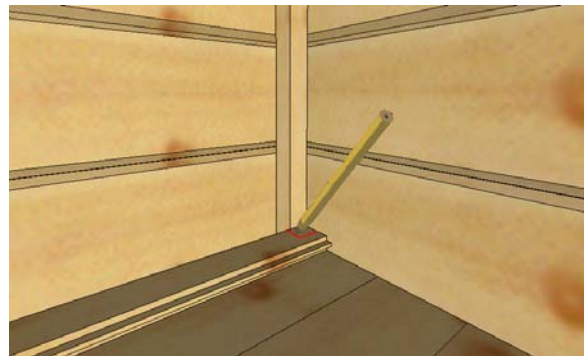

Slot the Penultimate board and final boards together and carefully slot into position ensuring the top layer of DPM has been lifted up and attached to the walls.

Once the final board have been placed into position Secure using 2 nails per floor beam.



Skirting boards

Once the floor boards have been nailed down, you can nail skirtings directly to the walls.

Before fixing the skirting please ensure that the DPM is secured to the walls.

You may want to trim some of the excess DPM away as the skirting will be fixed over the top

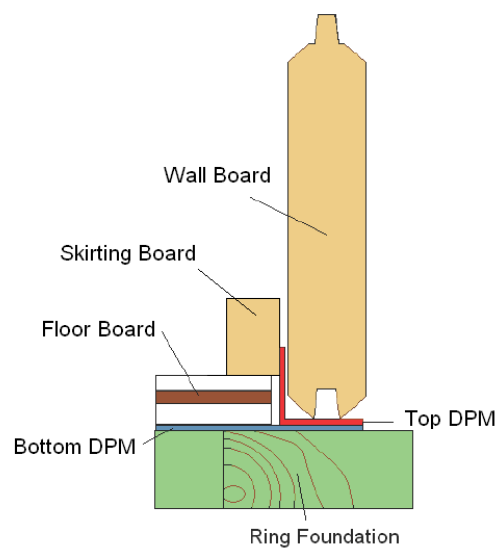

The skirting boards will need to be cut to suit the shape of the cabin. Trim and secure to the walls using the nails supplied.



Air vents

Locate the air vents and the fixings.

Decide on the location of the air vents, this should be on opposing walls.

The first air vent should be placed on the 2nd wall log from the bottom approximately 300mm in from the corner.



Use a 25mm spade bit or drill bit and drill 4 holes evenly as shown in the diagram.

Attach air vent face plate as shown in the diagram using the fixings supplied.



Place the second air vent on the opposing wall, on the second wall board below the eaves height. Position 300mm in from the corner.

Use a 25mm spade bit or drill bit and drill 4 holes evenly as shown (roof removed for illustration).

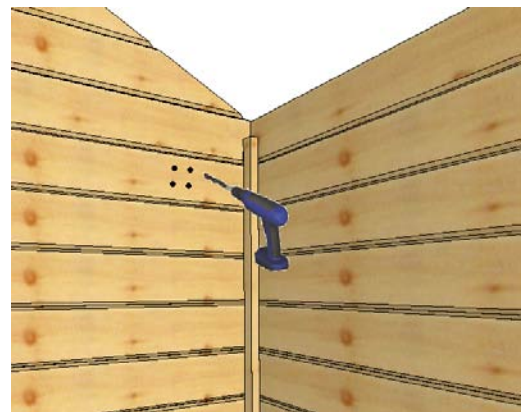



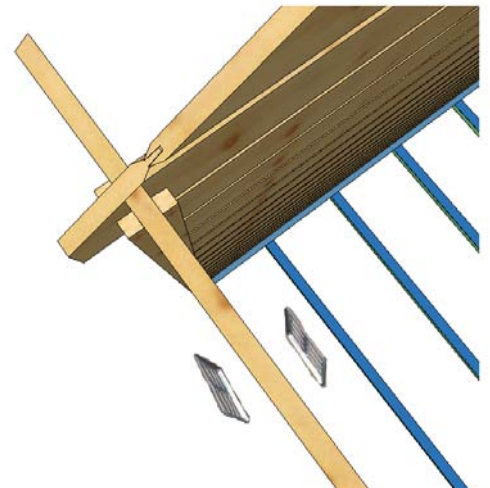

Attach air vent fascia plate as shown in the diagram using the fixings supplied.

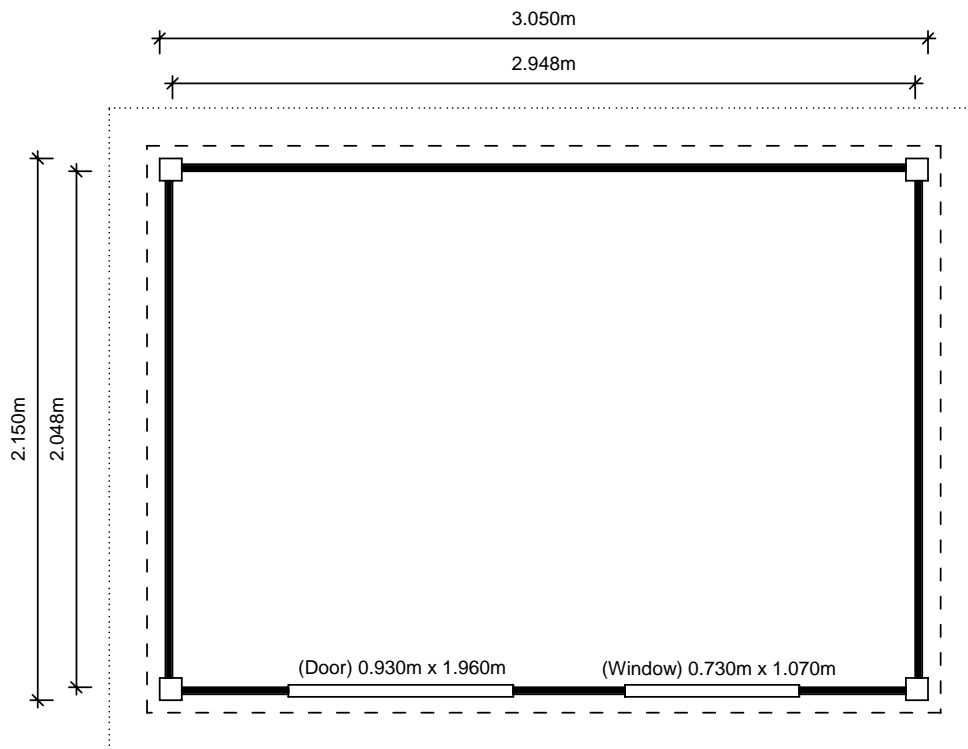

144771 Floor Plans

Floor Plan







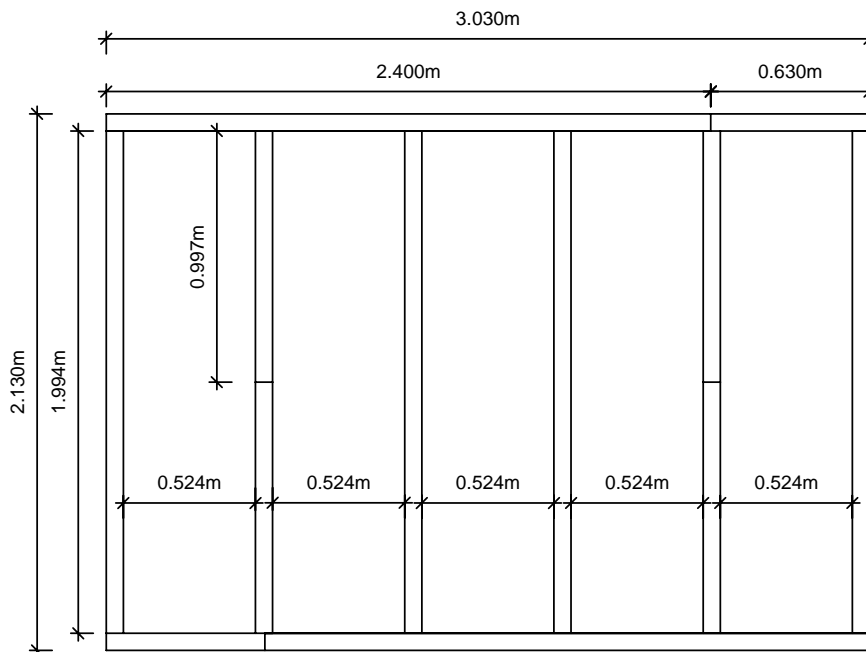

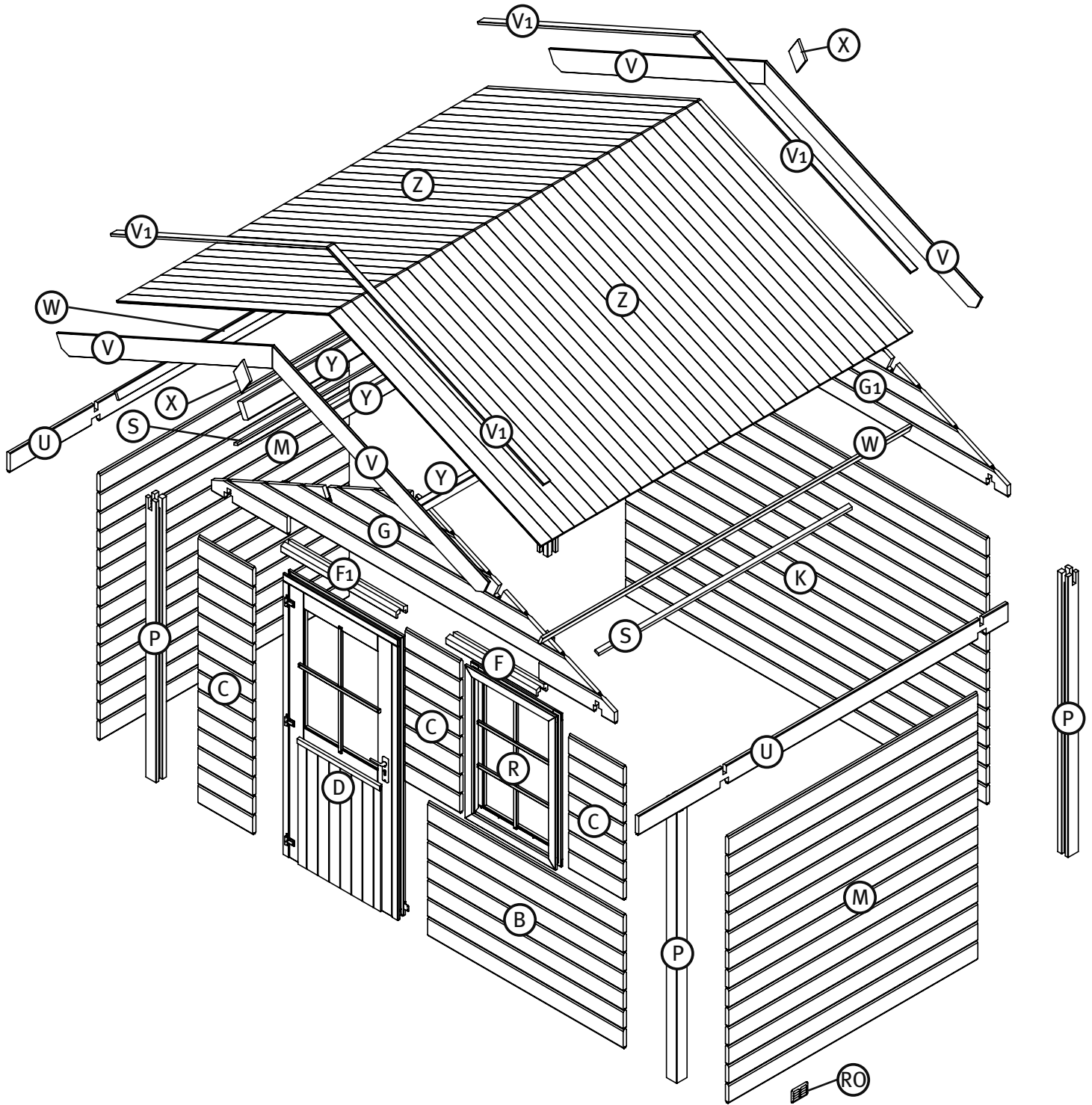



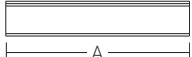



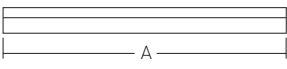
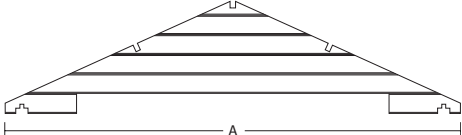
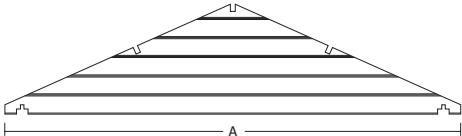

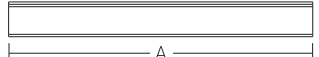
-  Cabin walls.
 -  Concrete foundation (optional) - this should be made to the same dimensions as the stated floor plan.
 -  Compressed gravel (optional) - this should be made 300mm larger than the stated floor plan in each direction.
- Base sizes shown are a minimum requirement.

Floor Beam Layout



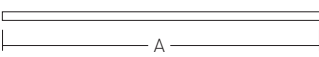

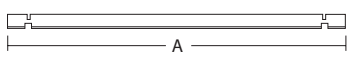

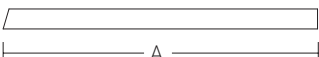



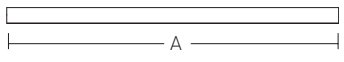

Parts list

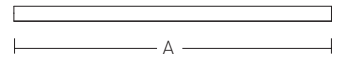
144771 Parts List							<input checked="" type="checkbox"/>
list of parts	A	B	C	part ref.	quantity	checklist	
		1578	27	133	B	7	<input type="checkbox"/>
		443	27	133	C	29	<input type="checkbox"/>
		730	32	57	F	2	<input type="checkbox"/>
		930	32	57	F1	2	<input type="checkbox"/>
		3250		27	G	1	<input type="checkbox"/>
		3250		27	G1	1	<input type="checkbox"/>
		2910	27	133	K	14	<input type="checkbox"/>
		2010	27	133	M	28	<input type="checkbox"/>
		1960	86	86	P	4	<input type="checkbox"/>
		2046	15	38	S	2	<input type="checkbox"/>
		2980	27	138	U	2	<input type="checkbox"/>
		1910	16	145	V	4	<input type="checkbox"/>

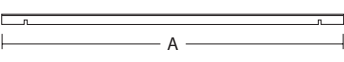
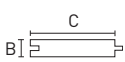
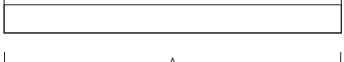
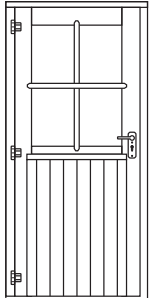
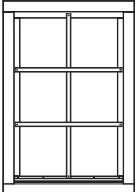
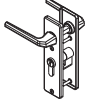
Continued...



list of parts	A	B	C	part ref.	quantity	checklist	
		1910	15	55	V1	4	<input type="checkbox"/>
		2980	18	55	W	2	<input type="checkbox"/>
		16	115	150	X	2	<input type="checkbox"/>
		2980	45	117	Y	3	<input type="checkbox"/>
		1870	15	90	Z	66	<input type="checkbox"/>
		930		1960		1	<input type="checkbox"/>
		730		1070		1	<input type="checkbox"/>
		Door Handle			D1	1	<input type="checkbox"/>
		Window Handle			W3	1	<input type="checkbox"/>
		Adjustable Corner Bracket			Q3-28	4	<input type="checkbox"/>
		Wall Board Bracket			Q1028	4	<input type="checkbox"/>



Continued...



list of parts	A	B	C	part ref.	quantity	checklist
	Wall Board Bracket			Q2-28	4	<input type="checkbox"/>
	Door Frame Bracket			KA1	2	<input type="checkbox"/>
	Air Vent			R0	4	<input type="checkbox"/>
	Washers			CR	4	<input type="checkbox"/>
	60	4		SC1	20	<input type="checkbox"/>
	40	4		SC2	25	<input type="checkbox"/>
	30	4		SC3	50	<input type="checkbox"/>
	30	5		BK1	4	<input type="checkbox"/>
	20	4		BK2	120	<input type="checkbox"/>
	45	2		BK2	650	<input type="checkbox"/>
	15	3		AS		<input type="checkbox"/>
	Corner Bracket			A	4	<input type="checkbox"/>
	Connecting Bracket			B	6	<input type="checkbox"/>

Continued...

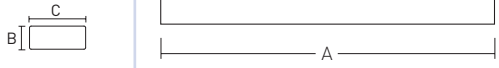
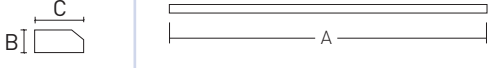
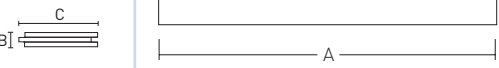

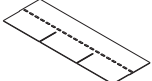
list of parts	A	B	C	part ref.	quantity	checklist
	2400	28	68	C	8	<input type="checkbox"/>
	2400	19	45	D	4	<input type="checkbox"/>
	2370	18	90	E	28	<input type="checkbox"/>
	Nails			F	400	<input type="checkbox"/>
	Roof Shingles			RS6	105	<input type="checkbox"/>

Timber treatments

Your log cabin will last longer if you treat the timbers (interior and exterior) with preservative. Do not treat your timbers until you have completely finished building.

NB: DO NOT TREAT THE INTERNAL WALLS OF YOUR CABIN IF YOU INTEND TO USE IT AS A SAUNA.

Wood - a natural material

Wood is a natural material. No two boards in your cabin are alike. They will expand and contract to reflect changes in the moisture content of their surroundings. They come with natural markings and imperfections.

Expansion and contraction may cause slight deformation in some of your cabin components. If joints are tight, they can be eased by paring with a knife or a chisel.

After construction, the entire cabin will tend to settle. The amount of settling varies from building to building. After a few weeks, check joints and screws. Some screws may need to be tightened or relocated. Doors and windows may need adjustment.

After a while cracks may appear in some timbers. No need to worry: cracks are natural. They will not reduce the strength or the warmth of your cabin.

Health and safety

Take care when building your log cabin. Wear safety goggles when drilling, cutting, or sawing; wear gloves when hammering. Always cut away from you when you use a knife or a chisel; do not wrap your fingers behind any piece of wood that you are cutting or sawing.

Pay particular attention when using ladders or working on the roof. Make sure your ladder is vertical, that it stands on firm ground, and that it's leaning on a solid object. Do not leave heavy or sharp objects in places where they could fall down.

Wood creates splinters. You can minimise the chance of catching a splinter in your hands by wearing safety gloves.

Take care when applying preservative. Follow the manufacturer's instructions if preservative gets in eyes or on skin or clothes.

Keep children away from the area where you are working, and away from ladders, tools and cabin components. Do not let them climb on the cabin.

Customer service

If you want to discuss any aspect of the construction or care of your cabin, or if you want to report a damaged or missing component, please contact your technical team - their details

are stated on your confirmation letter, quoting the reference number displayed on the transit packaging.

Glossary

Some of the terms used in these instructions may be unfamiliar. This is what they mean.

architrave

door and window surround

cabin reference number

unique reference number to identify your cabin in case of a query – found on the packing label

cross-diagonal

measured length from corner to corner – when cross-diagonals are equal, your cabin is square

DPM

damp proof membrane

eaves

lowest part of the roof slope

fascia board

board attached to eaves or gable to cover exposed edges of roof boards

fascia cover board

board attached to eaves or gable to cover joint between roof boards and fascia boards

floor beam

darker impregnated beam that supports the floors

foundation beam

darker impregnated beam that supports the external walls

frame capping

capping with an L-shaped cross-section for the topmost architraves of doors and windows

full-height board

standard height wall board for cabin construction

gable

triangular section of wall between the two roof slopes

half-height board

half the height of a full-height board – the first board to be laid in cabin construction

ridge beam

main and uppermost supporting beam for roof

roof beam

intermediate supporting beam for roof

roof board

board that covers roof

storm batten

corner-fixed vertical timber for securing cabin walls

tongue and groove

interlocking joint between wall boards and floorboards

wall board

interlocking wooden board used in main cabin construction



For technical help please refer to the telephone number in your confirmation letter.

Finnlife® is a registered trademark of Finnforest UK.

Wood is the only building material that is truly renewable, if well managed. Forest certification schemes give assurance that the timber is legal and from sustainable sources. Finnforest UK sources certified timber over uncertified and is an approved Chain of Custody supplier.

FF3247 April 2010.

The photographs in this brochure are for illustration purposes only. Finnforest reserves the right to change the range without notice.