



# HX 3000 TB UK



EN

GENERATING SET USER  
AND  
MAINTENANCE MANUAL



33522129801\_0\_1

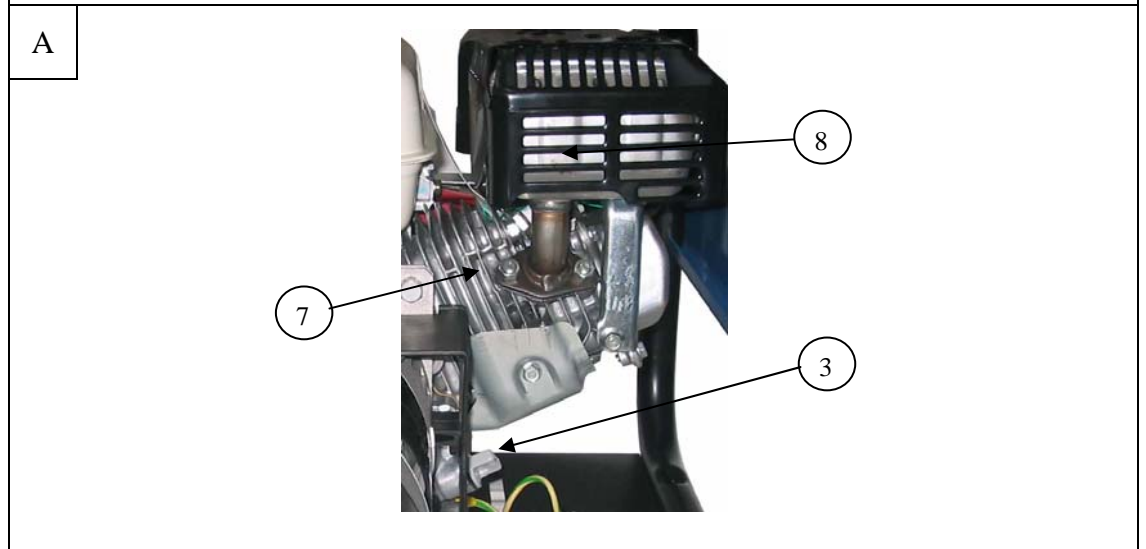
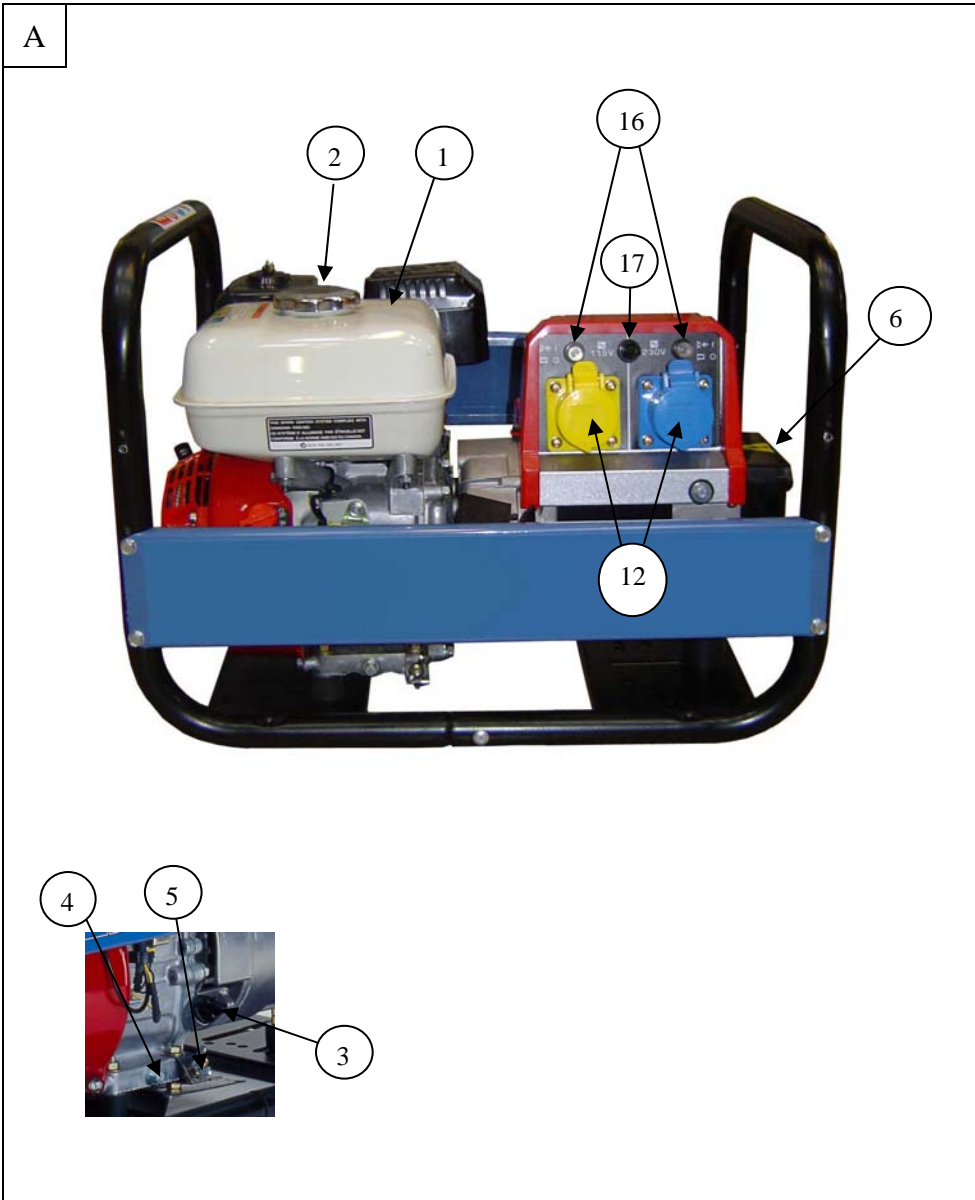

A

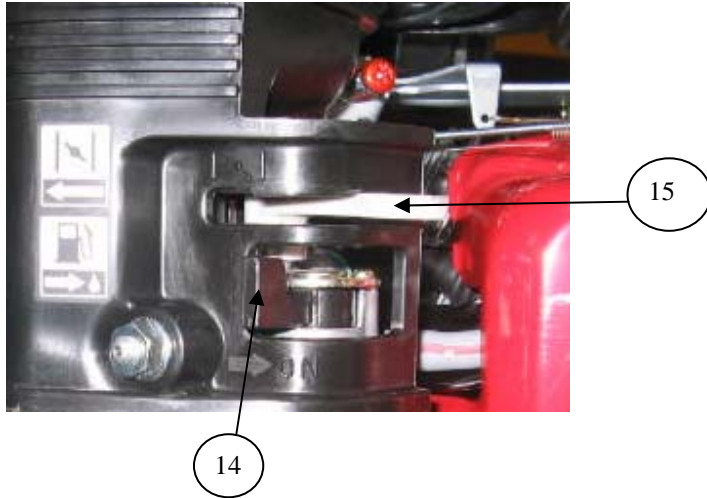

B

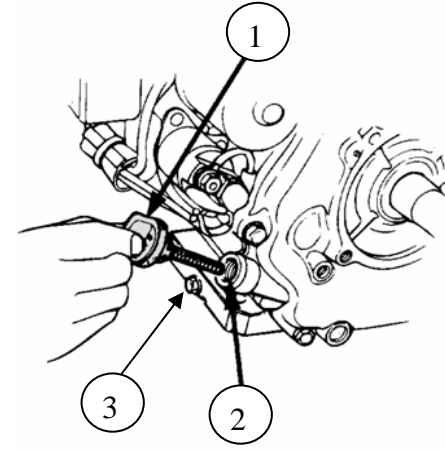

C

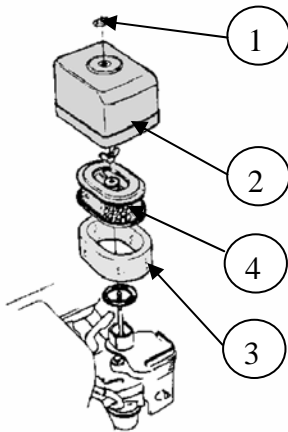

D

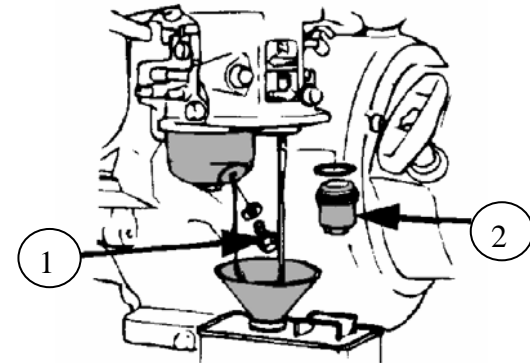

E

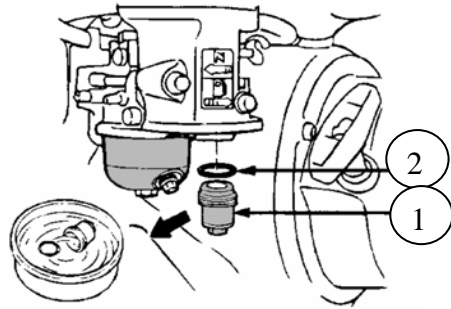

F

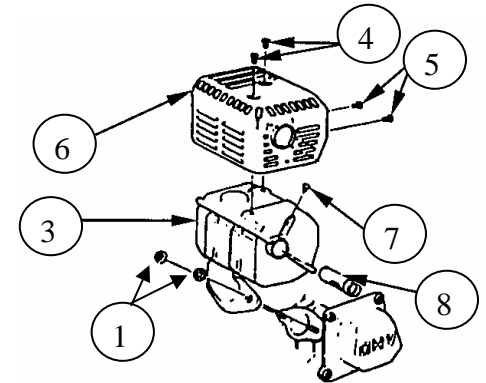
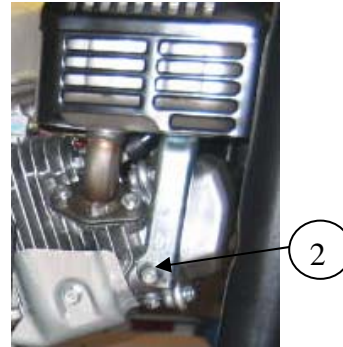

G

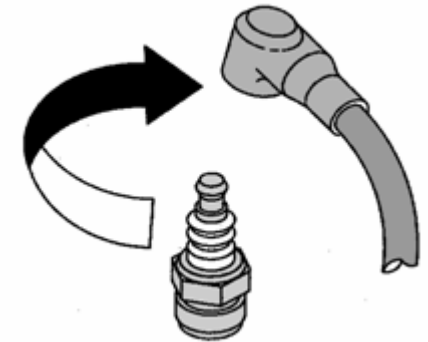
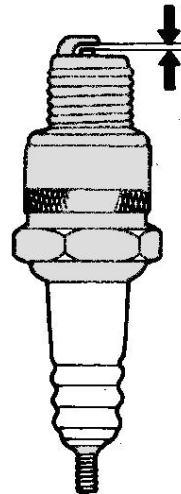
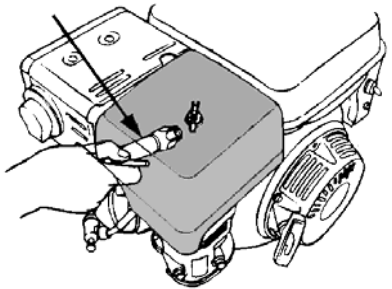

## Contents

1. Preface 2. General description 3. Preparation before starting 4. Using the generator set 5. Safety features (if fitted, see specifications table) 6. Maintenance schedule	7. Maintenance procedures 8. Storing the generating set 9. Fault finding 10. Specifications 11. Cable sizes 12. EC Declaration of conformity
---	---

### 1. Preface

#### 1.1. Recommendations

Thank you for buying one of our generating sets. We recommend that you read this manual carefully and follow the safety and maintenance advice and user instructions for your generating set very closely.

The information contained in this manual is taken from technical data available at the time of print. In the intention of permanently improving the quality of our products, this information may be amended without warning.

#### 1.2. Pictograms and plates on the generating sets and what they mean

 Danger	 Warning: risk of electric shock	 ER P31-02A Warning: the generating set is supplied without oil. Always check the oil level before starting the generating set.
 Earth	 Danger, risk of burns	

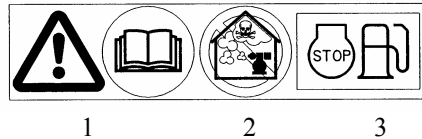

- 1 - Important: refer to the documentation accompanying the generating set.  
 2 - Warning: emission of toxic exhaust gases. Do not use in a confined or poorly ventilated area.  
 3 - Stop the motor before filling with fuel.

A = Generating set model B = Generating set output C = Voltage D = Amperage E = Current frequency F = Power factor	<p style="text-align: center;">Example of an identification plate</p>	G = Protection rating H = Generating set noise output I = Generating set earth J = Reference Standard K = Serial number
---	---	---

### 1.3. Instructions and safety regulations

 Danger	Do not run the generating set without having put back the protective covers and closed the access doors. Never take the protective covers off or open the access doors if the generating set is running.
------------	---

#### 1.3.1 Warnings

You are likely to encounter several warning symbols in this manual.

 Danger	This symbol indicates a definite risk to the health and life of people. Not following this instruction may seriously affect the health of people or prove fatal.
------------	--

 Warning	This symbol draws attention to the potential risk to the health and life of people. Not following this instruction may seriously affect the health of people or prove fatal.
-------------	--



	This symbol indicates a dangerous situation if the warning is not heeded. Not following this instruction could result in non-serious injury or damage.
Warning	

### 1.3.2 General advice

One of the fundamental safety considerations is observation of the interval between maintenance procedures (see maintenance schedule). Furthermore, never attempt to carry out repairs or maintenance procedures without the necessary experience and/or tools. When you take delivery of your generating set, check that it is complete and not damaged in any way. A generating set should be handled gently, avoiding sudden movements, and the place where it is to be stored or used should be carefully prepared beforehand.

	Before use, it is essential that you know how to stop the generating set immediately and that you thoroughly understand all the controls and operations.
Warning	

Never let other people use the generating set without giving them all necessary instructions beforehand.

Never let children touch the generating set, even when it is not in operation. Do not operate the generating set near animals (as it could cause them to panic).

Never start the motor without an air filter or exhaust.

Never invert the positive and negative battery terminals (if fitted) when connecting them. Such an inversion can lead to severe damage to the electrical equipment.

Never cover the generating set with any type of material while it is in operation or just after it has been turned off. Wait until the motor is cold.

Never coat the generating set with oil in an attempt to protect it from corrosion. Some preservative oils are flammable. Also, some are dangerous to inhale.

In all cases, respect the local regulations currently in place concerning the use of generating sets.

### 1.3.3 Safety guidelines to prevent electrocution

	While they are in operation, generating sets produce electric current. Connect the generating set to earth each time you use it, in order to prevent electrocution.
Danger	

Never touch stripped cables or disconnected connectors. Never handle a generating set with wet hands or feet. Never expose the equipment to liquid splashes or rainfall, and do not place it on wet ground. Always keep the electrical cables and the connections in good condition.

Do not use equipment in a poor state of repair which could lead to electrocution or damage to the equipment.

Use a differential protection device between the generating set and the appliances if the cable or cables used are more than 1 metre in length. This device must be positioned at a maximum distance of 1 metre from the generating set electrical sockets. Use flexible, durable cables, with rubber sheathing, conforming to the IEC 60245-4 standard or equivalent cables. Do not connect the generating set to other power sources, such as the mains. In specific cases where there is provision for a reserve connection to existing electrical networks, this must only be carried out by a qualified electrician, who should take the operating differences of the equipment into account, according to whether the public distribution network or generating set is being used.

Special circuit breakers designed for use with generating sets are used to prevent electrocution. If these circuit breakers need to be replaced, circuit breakers with identical nominal ratings and specifications must be used.

### 1.3.4 Safety guidelines to prevent fire

	Keep all inflammable materials (e.g.: petrol, oil, fabric etc.) out of the way when the generating set is in operation. The motor should not be operated in areas containing explosive products. There is a risk of sparks forming where all electrical and mechanical components are not shielded. Never cover the generating set with any materials while it is operating or just after it has been switched off (wait for the motor cool down).
Danger	

### 1.3.5 Safety guidelines for exhaust gases

	Exhaust gases contain carbon monoxide, which is a highly toxic substance. This substance can cause death if it is present in excessive concentrations in the air inhaled. For this reason, always use the generating set in a well ventilated area, where gases will not be able to accumulate.
Danger	

Good ventilation is required for your generating set to work properly. Without this, the motor would very quickly run at too high a temperature, which could lead to accidents or damage to the equipment and to surrounding items. However, if it is necessary to operate it inside a building, adequate ventilation must be provided, so that people and animals are not affected. It is imperative that exhaust gases are discharged outside.

### 1.3.6 Filling with fuel

	The fuel is highly flammable and its vapours are combustible. Smoking, using a naked flame or producing sparks are forbidden while the fuel tank is being filled.
Danger	Filling should be carried out with the motor turned off. All traces of fuel should be wiped off with a clean cloth.

Always place the generating set on a flat, level and horizontal surface to avoid fuel spillage from the tank onto the motor. Storage and handling of petroleum products must be carried out in accordance with the law. Close the fuel tap (if fitted) each time the tank has been filled. Fill the tank using a funnel, taking care not to spill any fuel. Then screw the petrol cap back on to the fuel tank as soon as filling is complete. Never top up fuel when the generating set is in operation or hot.

### 1.3.7 Safety guidelines against burns

	Never touch the motor or the silencer while the generating set is in operation, or when it has just stopped.
Warning	

Hot oil burns, avoid contact with the skin. Check that the system is no longer pressurised before carrying out any procedures. Never start or run the motor when the oil filler cap is off as oil may splash out.

### 1.3.8 Safety guidelines for handling batteries

	Never place the battery close to a flame or fire Use only insulated tools
Danger	Never use sulphuric acid or acid water to top up the electrolyte level.

### 1.3.9 Protecting the environment

Never drain or discard used oil onto the ground, but put it into a designated container. As far as possible, try to avoid sound reverberating through walls and buildings, as the noise will be amplified. If the exhaust silencer of your generating set is not fitted with a spark arrester and you need to use it in wooded, bushy or uncultivated areas, be extremely careful and make sure that sparks do not cause a fire (clear vegetation from a fairly large area where you wish to place your generating set).

### 1.3.10 Danger of moving parts

	Never go near a moving part that is in operation if you have loose clothing or long hair that is not enclosed in a protective hair net. Do not try to stop, slow down or impede a moving part when it is in operation.
Warning	

### 1.3.11 Capacity of the generating set (overload)

Never exceed the rated load of the generating set (in Amps and/or Watts) when it is running continuously.

Before connecting and operating the generating set, calculate the electrical power required by the electric appliances (in Watts). This electrical power rating is usually found on the manufacturer's plate on bulbs, electrical appliances, motors etc. The sum total of power required by these appliances should not exceed the nominal power rating of the generating set.

### 1.3.12 Operating conditions

The stated outputs of the generating sets are obtained in example conditions according to ISO 3046-1:

+27°C, 100 m above sea-level, humidity level equal to 60 % or

+20°C, 300 m above sea-level, humidity level equal to 60 %.

Performance is reduced by approximately 4 % for every additional 10°C and/or approximately 1 % for every additional 100 m in altitude.

## 2. General description

### 2.1. Description of the generating set

Fuel tank (no. 1, fig. A)	Engine (no. 7, fig. A)	Starting handle (no. 13, fig. A)
Fuel tank plug (no. 2, fig. A)	Silencer (no. 8, fig. A)	Fuel tap (no. 14, fig. A)
Oil filler plugs (no. 3, fig. A)	Air filter (no. 9, fig. A)	Choke (no. 15, fig. A)
Oil drain plugs (no. 4, fig. A)	Engine switch (no. 10, fig. A)	Circuit breaker (no. 16, fig. A)
Earth connection (no. 5, fig. A)	Starter – recoil reel (no. 11, fig. A)	Current transformer switch (no. 17, fig. A)
Alternator (no. 6, fig. A)	Household sockets (no. 12, fig. A)	

### 3. Preparation before starting

#### 3.1. Checking the oil level

	Always check the engine oil level before starting.
---	--

Checking and topping up should be carried out with the generating set on a horizontal surface.

- ➊ Remove the grey-coloured plug-gauge (no. 1, Fig. B) on the exhaust side by unscrewing it, and wipe the gauge.
- ➋ Insert the gauge into the filler neck (no. 2, Fig. B) without screwing it up.
- ➌ Visually check the level and top up if necessary.
- ➍ Using a funnel, fill the oil sump until it overflows.
- ➎ Screw the cap back up again tightly in the filler tube.
- ➏ Check that there are no leaks.
- ➐ Wipe off excess oil with a clean cloth.

#### 3.2. Checking the fuel level

	Stop the engine before filling up with fuel and fill up in a well-ventilated area. Do not smoke, or bring naked flames or sparks near to the area where you are filling up with fuel or where the fuel is stored.
Danger	Only use clean fuel without any water. Do not overfill the tank (there should not be any fuel in the filler neck). When you have filled up, ensure that the tank cap is closed correctly. Take care not to spill any fuel when filling the tank. Before starting up the generating set, and if any fuel has been spilt, make sure that it has dried and that the vapours have cleared away.

Check the fuel level and top up if necessary:

- ➊ Unscrew the fuel tank cap (no. 2, fig A).
- ➋ Fill the tank (no. 1, fig A) using a funnel, taking care not to spill petrol.
- ➌ Screw the cap back on to the fuel tank.

#### 3.3. Earthing the generating set

To earth the generating set, use a 10 mm<sup>2</sup> copper wire attached to the generating set earth connection and to an earthing rod of galvanised steel set in the ground to a depth of 1 metre. This also dissipates the static electricity that builds up in the electrical machines.

#### 3.4. Positioning the generating set for operation

Place the generating set on a flat, horizontal surface which is firm enough to prevent the set sinking down (under no circumstances should the set tilt any direction by more than 10°).

Choose a site that is clean, well-ventilated and sheltered from bad weather, and store the additional supplies of oil and fuel within close proximity, although respecting a certain distance for safety.

### 4. Using the generator set

#### 4.1. Starting procedure

- ➊ Open the petrol tap by turning the control lever (no. 14, fig. A) to the right.
- ➋ Place the knob of the choke (no. 15, fig. A) on closed position as shown on the illustration.  
Note: Do not use the choke when the engine is warm or when the atmospheric temperature is high.
- ➌ Place the engine switch (no. 10, fig. A) on "ON" or "I".
- ➍ Seize the starting handle (no. 13, fig. A) correctly and pull it slowly until some resistance is felt, then let it return gradually.
- ➎ Take the starting handle again correctly, then pull the cord sharply and rapidly (pull it right out, using both hands if necessary). Allow the handle to return slowly by hand. If the engine has not started, repeat the operation until the engine starts by gradually opening the choke.
- ➏ When the engine has started, gradually open the choke (no. 15, fig. A).

#### 4.2. Operation

When the engine begins to heat up, gradually bring the knob of the choke (no. 15, fig A) to open position.

When the running speed of the generating set has stabilised:

- ➊ Check that circuit breaker (no. 16, fig A) is engaged.
- ➋ Connect the plug(s) to the generating set socket(s).



### 4.3. Electric current voltage selection

- ❶ Unplug the connected devices if necessary
- ❷ Put the switch on the desired voltage (no. 17, diag A), then plug back the devices on the sockets

### 4.4. Switching off

	When the generating set is turned off, the engine continues to give off heat. Appropriate ventilation should be provided after the generating set is turned off.
Warning	To stop the generating set urgently, place the engine switch on "OFF" or "O".

- ❶ Take the plugs out of the sockets and allow the engine to run without any charge for 1 to 2 minutes.
- ❷ Place the engine switch (no. 10, fig. A) on "OFF" or "O" and the set will stop.
- ❸ Close the fuel tap (no. 14, fig. A).

## 5. Safety features (if fitted, see specifications table)

### 5.1. Oil cut-out

This mechanism is designed to prevent any damage to the motor resulting from lack of oil in the motor sump. It automatically cuts out the motor. If the motor stops and will not restart, check the motor oil level before looking for any other cause of the problem.

### 5.2. Circuit breaker

The electrical circuit of the set is protected by several magnetothermal, differential or thermal cut-out switches. Any overload and/or short circuits cause the supply of electrical energy to be cut.

## 6. Maintenance schedule

### 6.1. Reminder of use

The maintenance interval frequency and the operations to be carried out are outlined in the maintenance programme. However, it should be added that it is the environment in which the generating set is operating which determines this programme. Accordingly, if the set is used in extreme conditions, shorter intervals between maintenance procedures should be adopted. These maintenance schedules apply only to generating sets running on fuel and oil, that conform to the specifications given in this booklet.

### 6.2. Maintenance table

carry out the maintenance procedures at whichever deadline is reached first		Each time it is used	First month or after the first 20 hours	Every 3 months or 50 hours	Every 6 months or 100 hours	Every 12 months or 300 hours
Engine oil	Check the level	•				
	Change		•		•	
Air filter	Check	•				
	Clean			• (1)		
Sediment bowl	Clean				•	
Spark plug	Check / clean				•	
Spark arrester	Clean				•	
Valve clearance	Check / adjust					• (*)
Strainer and petrol tank	Clean					• (*)
Cleaning the generating set					•	
Fuel line	Check (replace if necessary)		Every 2 years (*)			

Note: \* This procedure should be carried out by one of our registered agents

(1) : Perform air filter maintenance more frequently for operation in dusty locations.

## 7. Maintenance procedures

### 7.1. Cleaning the air filter

	Never use petrol or solvents with a low flash point for cleaning the air filter element as this could result in a fire or explosion.
Danger	

- ➊ Remove the wing nut (no. 1, fig. C) attaching the air filter cover (no. 2, fig. C), then remove the latter.
- ➋ Remove the wing nut attaching the filter.
- ➌ Remove the assembly consisting of foam (no. 3, fig. C) and paper (no. 4, fig. C) elements, and separate them. Check carefully that the two elements are not torn or pierced. Replace them if they are damaged.
- ➍ Foam element (no. 3, fig. C):
  - A) Wash the element in a solution of household cleaning product and warm water, then rinse thoroughly, or wash it in non-flammable solvent or solvent with a high flash point. Leave the element to dry fully.
  - B) Soak the element in clean engine oil and remove the excess oil. The engine will smoke when it is started for the first time if too much oil remains in the foam.
- ➎ Paper element (no. 4, fig. C):  
Tap the element lightly several times on a hard surface to remove excess dirt, or send compressed air through the filter, from the inside outward. Never try to remove dirt using a brush. Replace the element if it is too dirty.
- ➏ Carry out refitting following the reverse procedure to that used for removal.

### 7.2. Cleaning the sediment bowl

- ➊ Switch off the fuel tap (no. 14, fig. A).
- ➋ Unscrew the plug (no. 1, Fig. D) to drain the fuel.
- ➌ Fit the plug (no.1, Fig. D) back on.
- ➍ Remove the bowl (no. 1, Fig. E) and the seal (no. 2, Fig. E).
- ➎ Wash the bowl (no. 1, Fig. E) with non-flammable solvent or solvent having a high flash point. Leave to dry fully.
- ➏ Refit the seal and the bowl.
- ➐ Open the fuel tap (no.14, Fig. A) and check that there are no leaks.

### 7.3. Renewing the motor oil

Change the oil when the engine is still warm, to ensure that drainage is rapid and complete.

- ➊ Remove the filling plug-gauge (no. 1, fig. B) and the drain plug (no. 3, fig. B) and drain the oil into a suitable container.
- ➋ On completion, screw up again and tighten the drain plug (no. 3, fig. B).
- ➌ Fill the engine oil sump with the recommended oil, then check the level.
- ➍ Put in place and tighten the filling plug-gauge (no. 1, fig. B).
- ➎ Check that there is no oil leak after filling.
- ➏ Wipe off any trace of oil with a clean cloth.

### 7.4. Cleaning the spark arrester

- ➊ Loosen the three mounting bolts (no. 1, fig. F) and (no. 2, fig. F) from the silencer (no. 3, fig. F), then remove the latter.
- ➋ Loosen the four bolts (no. 4, fig. F) and (no. 5, fig. F) holding the silencer guard (no. 6, fig. F) and then remove silencer guard.
- ➌ Remove the mounting bolt (no. 7, fig. F) from spark arrester (no. 8, fig. F) and place it down.
- ➍ Using a wire brush, remove the carbon deposits from the spark arrester screen.  
Note: The spark arrester must have no holes or cracks. Replace if necessary.
- ➎ Refit the spark arrester (no. 8, fig. F), the guard (no. 6, fig. F) and the silencer (no. 3, fig. F) in the reverse order to removal.

### 7.5. Checking the spark plug

- ➊ Remove the spark plug cap and use a spark plug spanner to remove the spark plug.
- ➋ Visually inspect the spark plug and discard it if the electrodes are worn or if the insulation is split or chipped. If it is to be re-used, clean the spark plug with a wire brush.
- ➌ Measure the electrode gap with a feeler gauge. The electrode gap should be from 0.70 to 0.80 mm. Check that the spark plug washer is in good condition and screw the spark plug in by hand, in order to avoid damaging the threads.
- ➍ After fitting the spark plug, tighten it with a spark plug spanner to secure the washer.  
Note: when fitting a new spark plug, tighten it by 1/2 turn after it is in place, in order to press the washers tightly. For the installation of an old spark plug, tighten it by a 1/8–1/4 turn after it is in place, in order to press the washer tightly.

### 7.6. Checking bolts, nuts and screws

Daily, detailed checks of all nuts, bolts and screws are essential in order to prevent any accidents or breakdowns.

- ❶ Inspect the generating set as a whole before and after each use.
- ❷ Tighten any loose nuts or screws.  
**NB:** the tightening of cylinder head bolts should be carried out by a specialist. Contact your local agent.

### 7.7. Cleaning the generating set

- ❶ Remove all dust and debris from around the exhaust and clean the generating set using a cloth and a brush (cleaning with a water jet is not recommended, and cleaning with high-pressure cleaning equipment is forbidden).
- ❷ Carefully clean the motor air inlets and outlets and the alternator.
- ❸ Check the general condition of the generating set and, if necessary, replace any faulty parts.

### 8. Storing the generating set

Generating sets which are to remain unused for a long period of time must undergo certain procedures, in order to keep them in good condition. Check that the storage area is not dusty or humid. Clean the exterior of the generating set and apply rustproofing product.

- ❶ Close the fuel tap (**OFF** position), remove the sediment bowl and drain it.
- ❷ Open the fuel tap (**ON** position) and drain the petrol from the tank into a suitable container.
- ❸ Refit the sediment bowl and tighten fully.
- ❹ Drain the carburettor by loosening the drain screw. Collect the petrol in a suitable container.
- ❺ Change the engine oil.
- ❻ Remove the spark plug and pour about 15 ml of oil into the cylinder, then refit the spark plug.
- ❼ Leave the engine to run for a few moments to distribute the oil in the cylinder.
- ❽ Clean the generating set and cover the engine again to protect it from dust.
- ❾ Store the generating set in a clean, dry place.

### 9. Fault finding

The engine will not start	<b>Probable causes</b>		<b>Remedial action</b>	
		The generating set is being charged during start-up		Take it off charge
		Fuel level too low		Fill up with fuel
		The fuel tap is closed		Open the fuel tap
		Fuel supply blocked or leaking		Have the system repaired
		Blocked air filter		Clean the air filter
		Control on " <b>OFF</b> " or " <b>O</b> "		Place the control on " <b>ON</b> " or " <b>I</b> "
The engine cuts out	<b>Probable causes</b>		<b>Remedial action</b>	
		Blocked ventilation inlets		Clean the air inlet and outlet guards
		Probable overcharge		Check the charge
No electric current	<b>Probable causes</b>		<b>Remedial action</b>	
		Circuit-breaker tripped		Reset the circuit breaker
		Circuit-breaker faulty		Have it checked, repaired or replaced
		Faulty plug socket		Have it checked, repaired or replaced
		Faulty appliance supply lead		Change the lead
		Faulty alternator		Have it checked, repaired or replaced
Circuit breaker trips out	<b>Probable causes</b>		<b>Remedial action</b>	
		Faulty equipment or lead		Have it checked, repaired or replaced

## 10. Specifications

Model	HX 3000 TB UK	
Engine type	GX 200	
Output (Watts)	1840	2800
Direct current	X	
Alternating current	115V/16A	230V/12.2A
Socket type	1x10/16A 115V	1x10/16A 230V
Circuit breaker	●	
Oil guard	●	
Battery	X	
Acoustic pressure at 1 m	83 dB(A)	
Weight in kg (without fuel)	41	
Dimensions l x w x h in cm	59x46x43	
Recommended oil	SAE 15W40	
Oil sump capacity in L	0.6	
Recommended fuel	Unleaded petrol	
Fuel tank capacity in litres	3.6	
Spark plug	NGK – BPR6ES / DENSO : W20 EPR-U	

●: standard      ○: optional      X: impossible

## 11. Cable sizes

Rated current (A)	Cable lengths		
	0 – 50 metres	51 – 100 metres	101 – 150 metres
6	1.5 mm <sup>2</sup>	1.5 mm <sup>2</sup>	2.5 mm <sup>2</sup>
8	1.5 mm <sup>2</sup>	2.5 mm <sup>2</sup>	4.0 mm <sup>2</sup>
10	2.5 mm <sup>2</sup>	4.0 mm <sup>2</sup>	6.0 mm <sup>2</sup>
12	2.5 mm <sup>2</sup>	6.0 mm <sup>2</sup>	10.0 mm <sup>2</sup>
16	2.5 mm <sup>2</sup>	10.0 mm <sup>2</sup>	10.0 mm <sup>2</sup>
18	4.0 mm <sup>2</sup>	10.0 mm <sup>2</sup>	10.0 mm <sup>2</sup>
24	4.0 mm <sup>2</sup>	10.0 mm <sup>2</sup>	16.0 mm <sup>2</sup>
26	6.0 mm <sup>2</sup>	16.0 mm <sup>2</sup>	16.0 mm <sup>2</sup>
28	6.0 mm <sup>2</sup>	16.0 mm <sup>2</sup>	16.0 mm <sup>2</sup>

## 12. EC Declaration of conformity

Name and address of manufacturer

SDMO, 12 bis rue de la Villeneuve, CS 92848, 29228 BREST CEDEX 2

Description of the equipment

Product	Generating set
Make	SDMO
Type	HX 3000 TB UK
Electrical output supplied	
Rated output: 2240 W	

G. G. Le Gall, the manufacturer's authorised representative, hereby declares that the product conforms to the following EU Directives:

98/37/EC / *Machinery Directive*.

73/23/EEC / *Low Voltage Directive (modified by Directive 93/68/EEC)*

89/336/EEC / *Directive on Electromagnetic Compatibility (modified by directives 92/3/EEC and 93/68/EEC)*

2000/14/EC / *Directive relating to the Noise Emission of Outdoor Equipment*

For Directive 14 /2000 /EC

- Notified Body:

**CETIM SERVICE DIFFUSION**

**BP 67 F60304 - SENLIS**

- Compliance procedure: Appendix VI

- Sound pressure level guaranteed (L<sub>wa</sub>) : 96 dBA

References to harmonized standards used

- EN12601/EN1679-1/EN 60204-1

03/2006

G. Le Gall

