

Erbauer®



ERB121SDS

2 WARRANTY
YEARS

6 kg SDS-MAX ROTARY HAMMER



Erbauer®

Congratulations on your purchase of a quality power tool. This product should give you reliable service but for your peace of mind this Erbauer power tool does carry a 24-month guarantee, the terms of which are detailed below.

If this product develops a fault within the guarantee period contact your retailer.

Please retain this handbook in case you need to refer to safety, care or guarantee information in the future.

GUARANTEE

This **Erbauer** product carries a guarantee of 24 months. If your product develops a fault within this period, you should, in the first instance contact the retailer where the item was purchased.

This guarantee specifically excludes losses caused due to:

- Fair wear and tear
- Misuse or abuse
- Lack of routine maintenance
- Failure of consumable items (such as batteries) -Accidental damage
- Cosmetic damage
- Failure to follow manufacturer's guidelines
- Loss of use of the goods

This guarantee does not affect your statutory rights. This guarantee is only valid in the UK.

For further technical advice and spare parts, please contact the customer helpline number on 0870 205 2945.

6 kg SDS-MAX ROTARY HAMMER

SAFETY INSTRUCTIONS



WARNING! Read all instructions. Failure to follow all instructions listed below may result in electric shock, fire and/or serious injury.
SAVE THESE INSTRUCTIONS

1. Work area

- a. Keep work area clean and well lit.** Cluttered and dark areas invite accidents.
- b. Do not operate power tools in explosive atmospheres, such as in the presence of flammable liquids, gases or dust.** Power tools create sparks which may ignite the dust or fumes.
- c. Keep children and bystanders away while operating a power tool.** Distractions can cause you to lose control.

2. Electrical safety

- a. Power tool plugs must match the outlet. Never modify the plug in any way. Do not use any adapter plugs with earthed (grounded) power tools.** Unmodified plugs and matching outlets will reduce risk of electric shock.
- b. Avoid body contact with earthed or grounded surfaces such as pipes, radiators, ranges and refrigerators.** There is an increased risk of electric shock if your body is earthed or grounded.
- c. Do not expose power tools to rain or wet conditions.** Water entering a power tool will increase the risk of electric shock.
- d. Do not abuse the cord. Never use the cord for carrying, pulling or unplugging the power tool. Keep cord away from heat, oil, sharp edges or moving parts.** Damaged or entangled cords increase the risk of electric shock.
- e. When operating a power tool outdoors, use an extension cord suitable for outdoor use.** Use of a cord suitable for outdoor use reduces the risk of electric shock.
- f. Use a Residual Circuit Breaker on all 230V Power tools.** This can help minimise the risk of an electrical shock if an earth fault or short circuits occurs.
- g. If using a power cable extension ensure that the cable is fully unwound and that its length is less than 30 m.** Lengths over 30 m will effect the tools performance as a result of voltage drop.

3. Personal safety

- a. Stay alert, watch what you are doing and use common sense when operating a power tool. Do not use a power tool while you are tired or under the influence of drugs, alcohol or medication.** A moment of inattention while operating power tools may result in serious personal injury.
- b. Use safety equipment. Always wear eye protection.** Safety equipment such as dust mask, non-skid safety shoes, hard hat, or hearing protection used for appropriate conditions will reduce personal injuries.
- c. Avoid accidental starting. Ensure the switch is in the off-position before plugging in.** Carrying power tools with your finger on the switch or plugging in power tools that have the switch on invites accidents.

d. Remove any adjusting key or wrench before turning the power tool on. A wrench or a key left attached to a rotating part of the power tool may result in personal injury.

e. Do not overreach. Keep proper footing and balance at all times. This enables better control of the power tool in unexpected situations.

f. Dress properly. Do not wear loose clothing or jewellery. Keep your hair, clothing and gloves away from moving parts. Loose clothes, jewellery or long hair can be caught in moving parts.

g. If devices are provided for the connection of dust extraction and collection facilities, ensure these are connected and properly used. Use of these devices can reduce dust related hazards.

4. Power tool use and care

a. Do not force the power tool. Use the correct power tool for your application. The correct power tool will do the job better and safer at the rate for which it was designed.

b. Do not use the power tool if the switch does not turn it on and off. Any power tool that cannot be controlled with the switch is dangerous and must be repaired.

c. Disconnect the plug from the power source before making any adjustments, changing accessories, or storing power tools. Such preventive safety measures reduce the risk of starting the power tool accidentally.

d. Store idle power tools out of the reach of children and do not allow persons unfamiliar with the power tool or these instructions to operate the power tool. Power tools are dangerous in the hands of untrained users.

e. Maintain power tools. Check for misalignment or binding of moving parts, breakage of parts and any other condition that may affect the power tools operation. If damaged, have the power tool repaired before use. Many accidents are caused by poorly maintained power tools.

f. Keep cutting tools sharp and clean. Properly maintained cutting tools with sharp cutting edges are less likely to bind and are easier to control.

g. Use the power tool, accessories and tool bits etc., in accordance with these instructions and in the manner intended for the particular type of power tool, taking into account the working conditions and the work to be performed. Use of the power tool for operations different from intended could result in a hazardous situation.

5. Service

a. Have your power tool serviced by a qualified repair person using only Safety Instructions identical replacement parts. This will ensure that the safety of the power tool is maintained.

HEALTH ADVICE



WARNING! When drilling, sanding, sawing or grinding, dust particles will be produced. In some instances, depending on the materials you are working with, this dust can be particularly harmful to you (e.g. lead from old gloss paint).

You are advised to consider the risks associated with the materials you are working

with and to reduce the risk of exposure. You should:

- Work in a well-ventilated area.
- Work with approved safety equipment, such as those dust masks that are specially designed to filter microscopic particles.

ADDITIONAL SAFETY RULES FOR YOUR ROTARY HAMMER

This is a powerful rotary hammer. Caution needs to be observed when operating.

1. If the supply cord is damaged have it replaced by a qualified person.
2. Always wear a dust mask.
3. Dress in suitable overalls.
4. Safety boots are recommended at all times especially when using the chisel action.
5. Proper safety gloves are also recommended.
6. When using chisel a dust mask is necessary because of the dust created by the action.
7. Wear ear protectors. Exposure to noise can cause hearing loss.
8. This heavy duty high torque machine should not be used, while standing on a ladder.
9. Watch out for the initial torque reaction of the drill, especially when drill bit is tight.
10. Do not use damaged or worn drills.
11. Do not run the machine with any part of the casing missing or damaged.
12. Check walls for hidden electric cable, gas and electric pipe before you start any drilling task.
13. Chisel bits and drill bits may be flung out of the machine accidentally and cause serious injury.
14. Before starting to work, always check that the chisel or drill bit is properly locked in the chuck.
15. Vibrations can injure the hand-arm system. Keep exposure to vibrations as short as possible.
16. When carrying out work, always hold the drill with both hands and ensure that you have a stable standing position.
17. In cold weather or when the tool has not been used for a long time, let the tool warm up for a while by operating it under no load. This will loosen up the lubrication. Without proper warm up, hammering operation is difficult.
18. This Rotary Hammer has an Overload Clutch. If the drill becomes jammed or caught, the drive to the drill spindle is interrupted. Because of the forces that occur as result, always hold the machine securely with both hands and take a firm stance.
19. Always use the appropriate safety equipment that is required for the product e.g. goggles/safety spectacles, ear defenders (essential with tools with a noise rating of over 85 dB (A), gloves and face masks. In all cases ensure that the safety equipment is in good condition.

20. Ensure that if a side handle or stabilising handle is provided with the power tool then these are adjusted into a comfortable position and that both handles are used to securely grip the power tool when in use.
21. This Drill is not suitable for drilling with ANY core drills above 90 mm. Only core drills that can be used with hammer action can be used with this machine this normally excludes diamond core drills.

Double insulation: 

The tool is double insulated. This means that all the external metal parts are electrically insulated from the mains power supply. This is done by placing insulation barriers between the electrical and mechanical components making it unnecessary for the tool to be earthed.

Important note

Be sure the supply is the same as the voltage given on the rating plate. The tool is fitted with a two-core cable and plug.

Remove the mains plug from socket before carrying out any adjustment or servicing.

SYMBOLS



Read the manual



Warning



Wear gloves



Wear dust mask, eye & ear protection



Conforms to relevant European safety standards

6 kg SDS-MAX ROTARY HAMMER

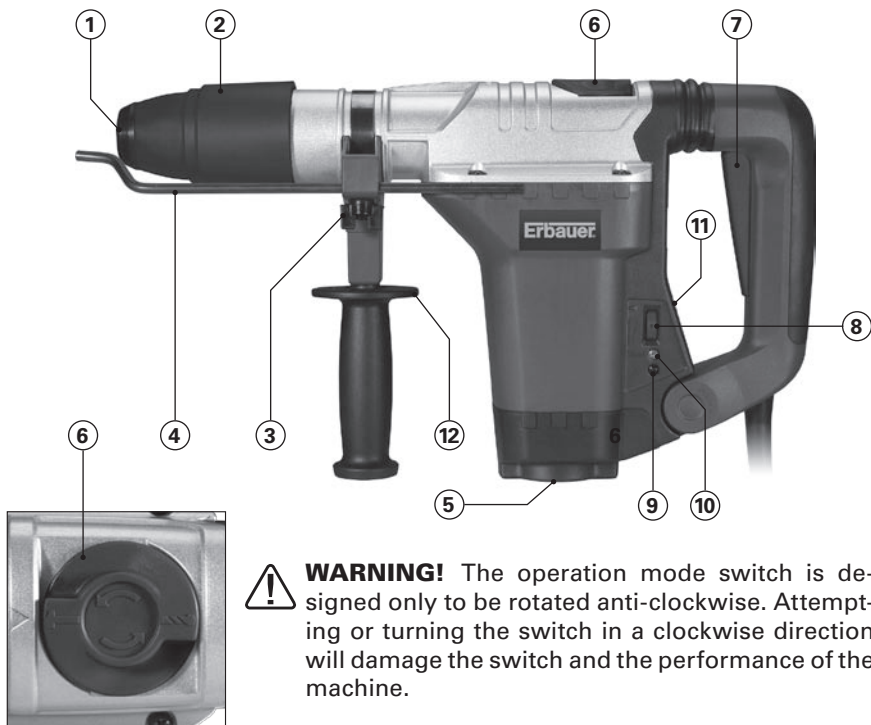

WARNING! The operation mode switch is designed only to be rotated anti-clockwise. Attempting or turning the switch in a clockwise direction will damage the switch and the performance of the machine.

1. SDS-MAX CHUCK & PROTECTION RING

2. LOCKING SLEEVE

3. DEPTH GAUGE LOCKING SCREW

4. DEPTH GAUGE

5. VENTILATION SLOTS

6. OPERATION MODE SELECTOR SWITCH

7. ON/OFF SWITCH

8. VARIABLE SPEED CONTROL

9. OVERLOAD INDICATOR

10. BRUSH WEAR INDICATOR

11. VENTILATION SLOTS

12. AUXILIARY HANDLE

TECHNICAL DATA

Voltage	230V~50Hz / 110V~50Hz	
Power input	1010W	
No load speed	200–325 / 350 min ⁻¹	
Max. impact rate	1900–3050 / 3300 min ⁻¹	
Max. Impact Energy	4–9 / 11 J	
Chuck	SDS-Max	
Drilling capacity in Concrete:	Twist Drill Bit:	40 mm
	Break Through Drill Bit:	55 mm
	Core Cutter: (Hammer suitable core cutter only):	90 mm
Double insulation (EN 60745-1)		
Weight (EPTA Procedure 01/2003)	6 kg	

NOISE AND VIBRATION DATA

Measured values determined according to EN 60745.

Noise emission:

A-weighted sound pressure level L_{pA}	95 dB (A)
Uncertainty K_{pA}	3 dB (A)
A-weighted sound power level L_{wA}	106 dB (A)
Uncertainty K_{wA}	3 dB (A)

Wear hearing protection!

Dust from material such as paint containing lead, some wood species, minerals and metal may be harmful. Contact with or inhalation of the dust may cause allergic reactions and/or respiratory diseases to the operator or bystanders.

Certain kinds of dust are classified as carcinogenic such as oak and beech dust especially in conjunction with additives for wood conditioning (chromate, wood preservative). Material containing asbestos must only be treated by specialists.

- Where the use of a dust extraction device is possible it shall be used.
- The work place must be well ventilated.
- The use of a dust mask of filter class P2 is recommended.

Follow national requirements for the materials you want to work with.

6 kg SDS-MAX ROTARY HAMMER

VIBRATION

The European Physical Agents (Vibration) Directive sets out minimum requirements applying across Europe for prevention of risk from vibration including hand arm vibration syndrome injuries to power tool users. Indicative vibration test results quoted below enable users to make informed decisions as to the period of time a power tool can be used safely on a daily basis and the choice of tool.

Further Advice on managing risks from vibration can be found at www.hse.gov.uk/vibration

Vibration total values (triax vector sum) determined according to EN 60745:

Work mode description 1 (if required by the relevant Part 2) Hammer drilling in concrete	Vibration emission value $a_{h,HD} = 13,5 \text{ m/s}^2$ Uncertainty $K_{KHD} = 1,5 \text{ m/s}^2$
Work mode description 2 (if required by the relevant Part 2) Hammering	Vibration emission value $a_{h,CHeq} = 11,5 \text{ m/s}^2$ Uncertainty $K_{CHeq} = 1,5 \text{ m/s}^2$

The declared vibration emission been measured in accordance with a standardised test stated above and may be used to compare one tool with another

The declared vibration emission value may also be used in a preliminary assessment of exposure.

Calculating the actual period of use can be difficult and the HSE website has a spreadsheet to help calculate exposures from multiple tool use, to help establish the need to limit the duration of tool use, etc.

 **WARNING:** The vibration emission value during actual use of the power tool can differ from the declared value depending on the ways in which the tool is used dependant on the following examples and other variations on how the tool is used:

- How the tool is used and the materials being cut or drilled.
- The tool being in good condition and well maintained
- The use of the correct accessory for the tool and ensuring it is sharp and in good condition.
- The tightness of the grip on the handles.
- And the tool is being used as intended by its design and these instructions.

This tool may cause hand-arm vibration syndrome if its use is not adequately managed.

 **WARNING:** identify safety measures to protect the operator that are based on an estimation of exposure in the actual conditions of use (taking account of all parts of the operating cycle such as the times when the tool is switched off and when it is running idle in addition to the trigger time).

Note. The use of other tools will reduce the users' total working period on this tool.

Helping to minimise your vibration exposure risk

ALWAYS use sharp chisels, drills and blades.

Maintain this tool in accordance with these instructions and keep well lubricated (where appropriate)

Avoid using tools in temperatures of 10°C or less (or where operation at low temperatures is unavoidable use appropriate clothing and gloves to keep warm and dry.)

Plan your work schedule to spread any high vibration tool use across a number of days.

Health Surveillance

All employees required to make regular and routine use of powered had-tools should be part of an employers health surveillance scheme to help identify any vibration related diseases at an early stage, prevent disease progression and help employees stay in work.

ACCESSORIES

Auxiliary handle	1pc
Depth gauge	1pc
Tube of grease	1pc
Cleaning cloth	1pc

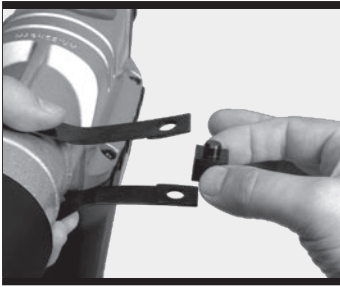

Fig. 1

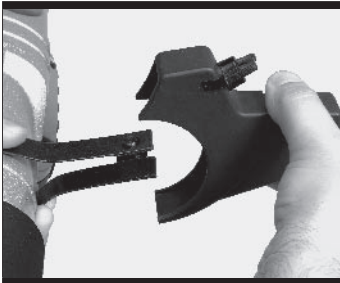

Fig. 2

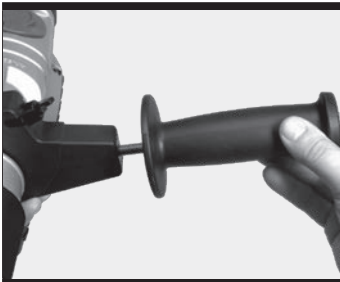

Fig. 3



Fig. 4

GENERAL DESCRIPTION

This ROTARY HAMMER can be used for hammer drilling and chiselling in masonry etc. work. The machine uses a single phase alternating current 110V or 230V, 50Hz motor, its compact and robust format makes it versatile and efficient for uses described in specific safety instructions. It complies with current regulations and the optimum quality of materials used will ensure a long working life in complete safety.

OPERATION INSTRUCTIONS



WARNING: Before using your Rotary Hammer be sure to read the instruction manual carefully.

Note: Make sure the hammer is isolated from the mains supply before fitting accessories. Before undertaking any maintenance or operations on the rotary hammer isolate the plug from the power supply.

1. AUXILIARY HANDLE (See Fig. 1, 2, 3)

Adjust the position of the auxiliary handle by turning the grip anti-clockwise to loosen the collar to suit application and add the depth gauge (4) if required.

Always use the auxiliary handle where possible to gain extra control and to prevent fatigue.

2. USING THE DEPTH GAUGE (See Fig. 4)

Loosen off the depth gauge retaining screw (3) insert depth gauge (11) into the handle. Adjust the depth gauge to desired depth and re-tighten the depth gauge retaining screw.

3. FITTING SDS-MAX DRILL BITS

(See Fig. 5, 6)

This rotary hammer is equipped with an SDS-Max attachment system. The SDS-Max tools have slots in the shank. These locate with tabs in the rotary hammer.

Apply a coating of universal grease to the end of the bit that is to be inserted into the SDS-Max chuck. Keep the locking sleeve (2) in upper (front) position while inserting the SDS-Max bit. Place the SDS-Max bit into the spindle without effort. Rotate the bit until the grooves coincide. After the grooves have coincided, push the SDS-Max bit down (until the fixing mechanism produces an audible “click”). Check the proper fixing of the SDS-Max bit by pulling it strongly outwards.

Note: The SDS-Max bit needs to be inserted in a specific way to ensure it locks into the chuck. To check if it is properly inserted attempt to pull the bit out of the chuck. If it can be removed without pulling back the locking sleeve (2), rotate the bit a little and repeat step 3 until the bit locks firmly into place.

4. FITTING SDS-MAX CHISELS

(See Fig. 7, 8)

These are inserted in the same way as drill bits. Once the bit is locked in place the bit can be rotated to the best position for the job in hand. Rotate the operation mode selector (6) to adjusting position (Fig 7). Once the position is set rotate the operation mode selector (6) to the chisel position **T**, ensuring that the button latches correctly. Then turn the bit slightly by hand left wise and right wise until it is locked.

5. REMOVE SDS-MAX TOOLS

(See Fig. 9)

Pull back the locking sleeve (2), grasp the bit and pull straight out.

6. OPERATING THE ON/OFF SWITCH

(See Fig. 10)

Holding the Rotary Hammer with both hands and press the ON/OFF switch (7) in for operation, release switch to stop.

WARNING: If the hammer/chisel selector cannot go into position, turn the drill bit in the SDS-Max chuck to allow the mode selector to engage properly.



Fig. 5

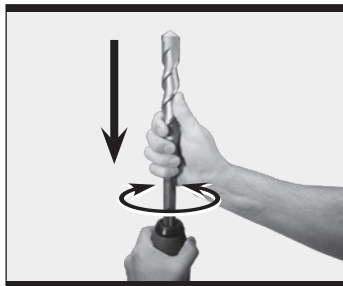

Fig. 6



Fig. 7



Fig. 8

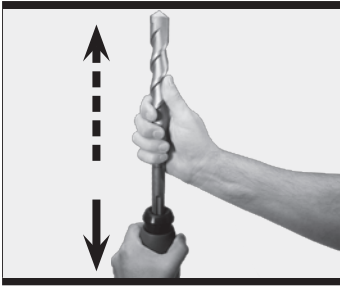

Fig. 9

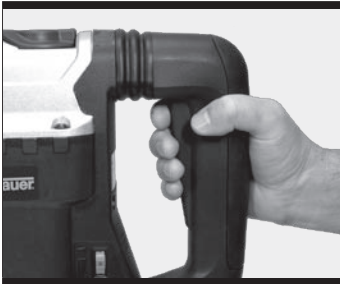

Fig. 10



Fig. 11

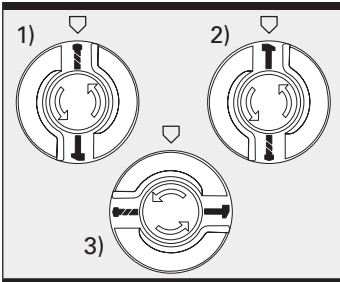

Fig. 12

Before operating, select required mode by aligning symbol on switch with arrow. Ensure selector is locked in position. It could cause a hazard if the selector switch is not firmly locked.

Note: In cold weather or when the tool has not been used for a long time, operate the rotary hammer for approximately 3 mins. under no load before Hammer Drilling or Chiselling.

7. VARIABLE SPEED CONTROL (See Fig. 11)

The speed of the Rotary Hammer is adjusted by the variable speed control (8) this sets the maximum/minimum speed and impact rate for the drill, with 'A' at the lowest speed/impact rate and 'G' the highest.

High Power Mode (position 8) should only be used for chiselling concrete or when using break through bit.

Selecting the speed, frequency and impact energy

Rotate the regulator (8) to choose a position appropriate for the processed material. The constant electronics maintain the speed, the frequency and the impact energy constant, independently of the load, thus ensuring steady operation mode. It is recommended to use the operation modes listed in the table.



Application	Regulator position	Rotation speed	Impact rate	Single impact energy
Render / Light construction materials	A – B	200–225 min ⁻¹	1900–2100 min ⁻¹	4 J
Bricks/ Chiselling tiles	C – D	250–275 min ⁻¹	2350–2600 min ⁻¹	6–7 J
Drilling in concrete	E – F	300–325 min ⁻¹	2850–3050 min ⁻¹	8–9 J
Chiselling concrete	G		3300 min ⁻¹	11 J

8. OPERATION MODE SELECTION

(See Fig. 12)

This must only be adjusted when the ON/OFF switch (7) has been released and the drill is not rotating.

Rotate mode selector switch (6) and rotate the switch to select

- 1)  Hammer drilling – hammer drilling in concrete, stone etc.
- 2)  Chiselling – chiselling/breaking in concrete and masonry.
- 3) Central Adjusting Position – adjusting the chisel position. Insert and fix the chisel in the best position for the job in hand and then re-set mode switch (6) to Chisel Position.

Note. During each switching between operation modes turn the bit slightly by hand left wise and right wise until it is locked.

9. HAMMER DRILLING ACTION (See Fig. 13)

Use good quality SDS-Max drill bits. Select the 'Hammer drilling' position on the operation mode selector.

Apply moderate pressure during operation (approximately 100-150N)! Higher pressure will not increase efficiency when drilling or chiselling, but will lead to decreasing the operation life of the machine and shortening the period between routine servicing.

This Rotary Hammer is fitted with an overload warning light (Fig. 14), which will glow continuously red, if the machine is overloaded by more than 30%.

The machine must not be operated continuously in this mode.

10. BUILT-IN DUST PROTECTION

(See Fig. 15)

The protective ring (1) preserves the tool socket from dirt during operation. While inserting tool bits, take care not to damage the protective ring.



Fig. 13



Fig. 14



Fig. 15



Fig. 16



Fig. 17

11. REPLACE A DAMAGED PROTECTIVE RING IMMEDIATELY!

(See Fig. 16)

To replace the protective ring, pull back the locking sleeve (2) grasp the protective ring and pull it towards you at an angle. Place the new protective ring onto the spindle and press home hard.

12. SERVICE INDICATOR (MAINTENANCE REQUIRED) (See Fig. 17)

When the red light-emitting diode (10) begins to blink while the machine operates normally, replacement brushes will be needed.

After approximately 8 hours further operation, the brushes are worn out completely and the safety switch actuates. The Machine will stop and the red diode light will blink constantly. Take the machine to an authorised repair agent for new brushes and preventative maintenance.

If the machine does not work before the 8-hour warning period is over and the warning Red light-emitting diode (10) keeps blinking, this probably indicates the motor is damaged. If there is no light indicator showing and the machine does not operate, this could mean that there is no power supply to the switch and either the automatic switch or the power cord is faulty.

13. PREVENTIVE MAINTENANCE

This Power tool should be sent periodically to a ERBAUER authorised service agent for preventive maintenance, which will lengthen the life of the machine.

Check 1

After approximately 70 hrs use, the machine should be evaluated and if necessary repaired.

Check 2

After approximately 140 hrs use or the brushes wearing out. The machine shall be cleaned thoroughly evaluated for potential and ascertained faults repaired (brushes and O ring seals should be replaced).

Check 3

After approximately 250 hrs use or the brushes

wearing out. The machine shall be cleaned thoroughly evaluated for potential and ascertained faults repaired (brushes and O ring seals should be replaced).

Check 4

After approximately 350 hrs use or the brushes wearing out. The machine shall be cleaned thoroughly evaluated for potential and ascertained faults repaired (brushes and O ring seals should be replaced).

14. CHISELLING ACTION

Use good quality SDS MAX chisels. Select the 'Chiselling' position **T** on the operation mode selector. This Rotary Hammer is suitable for chiselling and demolishing.



CAUTION! Care should be taken if asbestos is suspected of being drilled or chiselled. This is highly dangerous to the user and people in the vicinity and professional help should be sought for its removal and disposal.

15. OVERLOAD CLUTCH

The overload clutch will actuate when a certain torque level is reached. The motor will disengage from the output shaft. When this happens, the bit will stop turning. As soon as the overload clutch actuates, switch off the tool immediately. This will help prevent premature wear of the tool.

Once the drill bit has jammed the drill must be removed from the material before restarting.

16. CHISEL AND DRILL BITS

Do not use damaged/chipped/blunt drill bits. Inspect drill bits and chisel bits regularly for sign of damage and sharpness and replace where necessary.

17. SAFETY PRECAUTION FOR USING THE ROTARY HAMMER

This is a powerful rotary hammer. Caution should be observed when operating. Dress in suitable overalls. Safety boots are recommended at all

times especially when using the chisel actions. Proper safety gloves are also recommended. When using chisel a dust mask is necessary because of the cement dust created by the action. **Note:** If you see some sparks flashing in the ventilation slots do not panic, this is normal and will not damage the tool.

Working hints for your rotary hammer

- Always use sharp good quality drill bits and chisels. The performance of the machine is dependant on the quality of the bits used. Reduce the pressure on the drill bit when it is about to break through. This will prevent the drill from jamming.
- When drilling a large hole, first drill a pilot hole using a smaller drill bit.
- Always apply pressure to your drill bit in a straight line, and if possible at right angles to the work piece.
- When drilling holes into walls, floors etc., always make sure that there are no live electrical wires, or pipe work in the path of the bit. Always operate your drill using both the handle and the front handle.
- Never change the operating mode whilst the drill is running.
- When using the product in the hammer only mode, or when chiselling masonry, make sure that you wear safety glasses and protective gloves.
- Do not apply excessive pressure to the tool when chiselling. Excessive force does not speed up the work.

MAINTENANCE

There are no user serviceable parts in your power tool. Never use water or chemical cleaners to clean your power tool. Wipe clean with a dry cloth. Always store your power tool in a dry place. Keep motor ventilation slots clean. If you see some sparks flashing in the ventilation slots, this is normal and will not damage your power tool.

If the supply cord is damaged, it must be replaced by a special cord or assembly available from the manufacturer or its service agent.

TROUBLESHOOTING

If your rotary hammer will not operate, check the power at the mains plug.

If the drill is not drilling properly, check the drill bit for sharpness, replace drill bit if worn.

If a fault cannot be rectified return the rotary hammer to an authorized dealer for repair.

ENVIRONMENTAL PROTECTION



Waste electrical products should not be disposed of with household waste. Please recycle where facilities exist.

For further information visit www.recycle-more.co.uk

PLUG REPLACEMENT

The fuse in the main plug of your power tool should always be replaced with one of identical rating.

Check the voltage given on your power tool matches the supply voltage.

The power tool is supplied with a fitted plug, however if you should need to fit a new plug follows the instruction below.

IMPORTANT

The wire in the mains lead are coloured in accordance with the following code:

Blue — Neutral

Brown — Live

The wire that is coloured blue must be connected to the terminal that is marked with the letter **N**. The wire that is coloured brown must be connected to the terminal that is marked with the letter **L**.

A 10 AMP (BS1363 or BS1363/A) plug must be used and a 10 AMP fuse must be fitted.

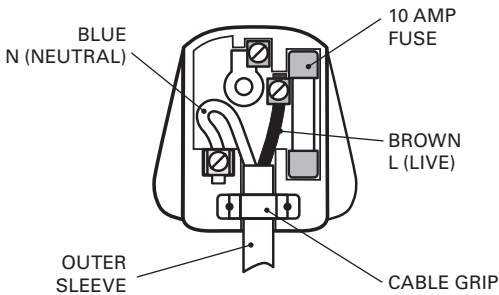

Erbauer®

Declaration of Conformity

We, Importer
Erbauer (UK) Ltd.
BA 22 8RT

Declare that the product
5kg SDS-Max Rotary Hammer
ERB121SDS

Complies with the essential health and safety requirements of the following directives:

98/37/EC – Machinery directive
2004/108/EC – Directive EMC
2006/95/EC – Low voltage equipment

Standards and technical specifications referred to:

EN 60745-1;
EN 60745-2-6;
EN 55014-1;
EN 55014-2;
EN 61000-3-2;
EN 61000-3-3

Authorised Signatory

Date: 01 March 2008

Signature: 

Name: Peter Harries
Erbauer (UK) Ltd.
Quality Manager



2008

6 kg SDS-MAX ROTARY HAMMER

6 kg SDS-MAX ROTARY HAMMER

Erbauer®