









# ELEKTRA BECKUM

## Ein Unternehmen der Metabo-Gruppe

-  Betriebs- und Wartungsanleitung für Farbspritzpistole
-  Operating and Maintenance Instructions Paint Spray
-  Notice d'utilisation et d'entretien du pistolet à peinture
-  Gebruikers- en onderhoudshandleiding voor Verfspuitpistool
-  Istruzioni per l'uso e la manutenzione per Pistola di spruzzatura per vernice
-  Manual de servicio y mantenimiento para Pistola pulverizadora
-  Betjenings- og betjeningsvejledning for sprøjtemalepistol
-  Anvisningar för drift och skötsel av färgspruta

English only

115 366 5450 / D/ENG/F/NL/IT/ES/DA/SV / 1001 - 1.2

FB 2200 HVLP  
FB 2200  
FB 150  
SB 200

FB 2200 HVLP Best.-Nr. 090 105 4460  
FB 2200 Best.-Nr. 090 105 4452  
FB 150 Best.-Nr. 090 100 3874  
SB 200 Best.-Nr. 090 100 3882



**D DEUTSCH****KONFORMITÄTSERKLÄRUNG**

Wir erklären in alleiniger Verantwortlichkeit, daß dieses Produkt mit den folgenden Normen übereinstimmt\* gemäß den Bestimmungen der Richtlinien\*\*

**F FRANÇAIS****DECLARATION DE CONFORMITE**

Nous déclarons, sous notre seule responsabilité, que ce produit est en conformité avec les normes ou documents normatifs suivants\* en vertu des dispositions des directives\*\*

**IT ITALIANO****DICHIARAZIONE DI CONFORMITÀ**

Noi dichiariamo sotto la nostra esclusiva responsabilità che il presente prodotto è conforme alle seguenti norme\* in conformità con le disposizioni delle normative\*\*

**PT PORTUGUÊS****DECLARAÇÃO DE CONFORMIDADE**

Declaramos sob nossa responsabilidade que este produto está de acordo com as seguintes normas\* de acordo com as directrizes dos regulamentos\*\*

**FIN SUOMI****VAATIMUKSEN MUKAISUUSVAKUUTUS**

Vakuutamme, että tämä tuote vastaa seuraavia normeja\* on direktiivien määräysten mukainen\*\*

**DA DANSK****OVERENSSTEMMELSEATTEST**

Hermed erklærer vi på eget ansvar, at dette produkt stemmer overens ed følgende standarder\* iht bestemmelserne i direktiverne\*\*

**EL ΕΛΛΗΝΙΚΑ****ΔΗΛΩΣΗ ΑΝΤΙΣΤΟΙΧΕΙΑΣ**

Δηλώνουμε με ίδια ευθύνη ότι το προϊόν αυτό αντιστοιχεί στις ακόλουθες προδιαγραφές\* σύμφωνα με τις διατάξεις των οδηγιών\*\*

**ENG ENGLISH****DECLARATION OF CONFORMITY**

We herewith declare in our sole responsibility that this product complies with the following standards\* in accordance with the regulations of the undermentioned

**NL NEDERLANDS****CONFORMITEITSVERKLARING**

Wij verklaren als enige verantwoordelijke, dat dit product in overeenstemming is met de volgende normen\* conform de bepalingen van de richtlijnen\*\*

**ES ESPAÑOL****DECLARACION DE CONFORMIDAD**

Declaramos bajo nuestra exclusiva responsabilidad, que el presente producto cumple con las siguientes normas\* de acuerdo a lo dispuesto en las directrices\*\* Homologación de

**SV SVENSKA****FÖRSÄKRAN OM ÖVERENSSTÄMMELSE**

Vi försäkrar på eget ansvar att denna produkt överensstämmer med följande standarder\* enligt bestämmelserna i direktiven\*\*

**NO NORGE****SAMSVARSERKLÆRING**

Vi erklærer under eget ansvar at dette produkt samsvarer med følgende normer\* henhold til bestemmelsene i direktiv\*\*

**POL POLSKI****OŚWIADCZENIE O ZGODNOŚCI**

Oświadczamy z pełną odpowiedzialnością, że niniejszy produkt odpowiada wymogom następujących norm\* według ustaleń wytycznych\*\*

**HU MAGYAR****MEGEGYZŐSÉGI NYILATKOZAT**

Kizárólagos felelősségünk tudatában ezennel igazoljuk, hogy ez a termék kielégíti az alábbi szabványokban lefektetett követelményeket\* megfelel az alábbi irányelvek előírásainak\*\*

**FB 2200 HVLP - FB 2200 - FB 150 - SB 200**

\* EN 292-1, EN 292-2, EN 837

\*\* 89/392/EWG, 93/68/EWG

Jürgen Kusserow  
Vorstand



ELEKTRA BECKUM AG – Daimlerstraße 1 – 49716 Meppen

1000930/ 00





ENG

### 1. Getting to Know Your Paint Spray Gun FB 2200 HVLP, FB 2200, FB 150 and SB 200

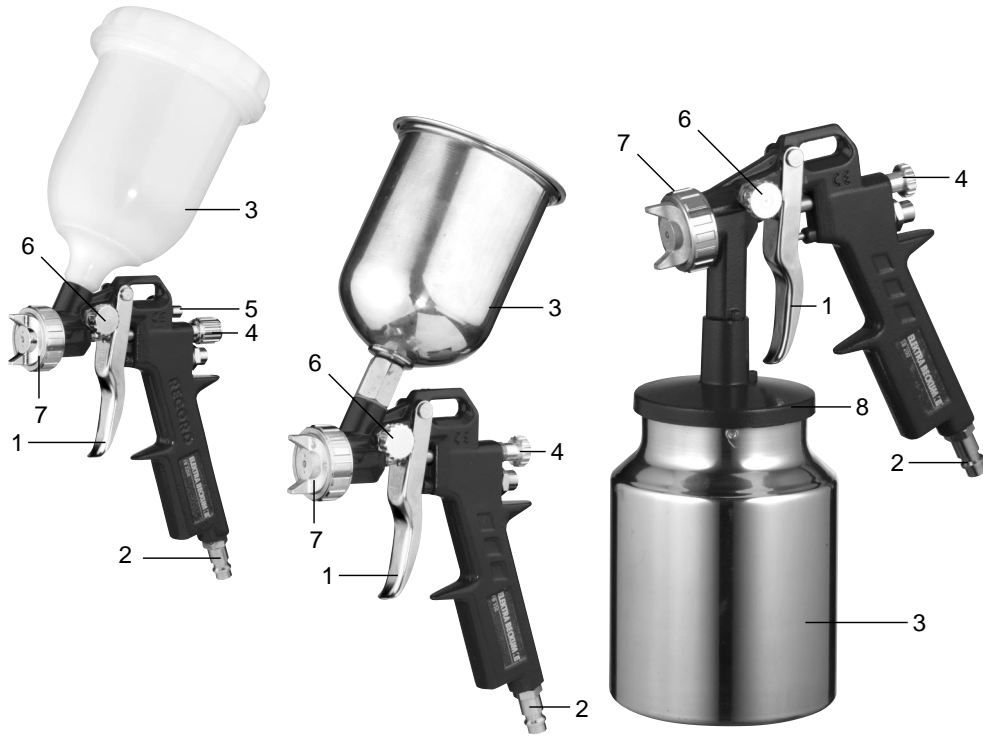

FB 2200 HVLP  
FB 2200

FB 150

SB 200

Item	Description
1	Trigger
2	Air inlet
3	Flow cup/siphon cup
4	Fluid regulating screw
5	Air control valve
6	Adjusting screw for round and wide spray pattern
7	Nozzle
8	Quick-release clamp for cup





## Contents

1. Getting to Know Your Paint Spray Gun FB 2200 HVLP, FB 2200, FB 150 and SB 200
2. Please Read First!
3. Specified Conditions of Use
4. Safety Instructions
5. Initial Operation
6. Care and Maintenance
7. Specifications
8. Standard Delivery
9. Accessories

## 2. Please Read First

- Read instructions before commissioning, especially the safety instructions.
- If you notice transport damage while unpacking, notify your supplier immediately. Do not operate the air tool!
- Dispose of the packing in an environmentally friendly manner. Take to a proper collecting point.
- Keep instructions for future use.
- If you lend or sell this air tool be sure to have the instructions to go with it.

## 3. Specified Conditions of Use

These Paint Spray Guns are handy, air-powered paint spray guns for use in DIY and trade.

They are especially suitable for spraying larger objects.

The air stream atomises the spraying material into very fine particles, resulting in excellent paint transfer and a high quality finish.

The spray pattern is adjustable from round to wide (item 6) and can be adopted to the object to be sprayed.

For larger objects, the nozzle adjusts steplessly from horizontal to vertical pattern.

The amount of paint can be proportioned by means of the fluid regulating screw (item 4), making these spray guns very versatile.

Special feature of the HVLP version: The HVLP (high volume low pressure) system reduces the paint consumption and increases material transfer. Savings of up to 30% in spraying material are possible. When working with the HVLP system it is important not to exceed the max. pressure of 2.6 bar.



## 4. Safety Instructions

Protect yourself and your environment by suitable precautions against dangers of accident.

- The paint spray gun is not suitable for treatment of foods or medicines.
- Do not smoke, strike sparks or light fires.
- Ensure good ventilation of the work area.
- Wear protective clothing, especially respiratory equipment with activated carbon filter.
- Do not use the paint spray gun for any purpose it was not designed for.
- Be careful when handling inflammable materials.
- Keep air tools out of the reach of children.
- Always be rested and concentrated when working with the paint spray gun.
- Never direct the paint spray gun against other persons or animals.
- Connect to pressurised air supply only with a quick coupler.
- Working pressure must be set by means of a filter/pressure regulator.
- Do not use oxygen or fuel gas as energy source.
- Disconnect from air source before servicing.
- Solvents and residue paint must be disposed of in an environmentally friendly manner.





## 5. Initial Operation

Connect the paint spray gun to a suitable pressurised air source by means of a flexible air hose fitted with a quick coupler. Set the filter pressure reducer of the pressurised air source to the required working pressure (max. 5 bar). Follow the paint manufacturer's instructions for preparing the spraying material. Too much working pressure causes a very fine spraying material atomisation with rapid evaporation, resulting in a rough surface finish and poor bonding. If the air pressure is too low, the spraying material will be insufficiently atomised, resulting in rippled surfaces and drip marks. The paint spray gun is operated by pulling the trigger (item 1). Always hold paint spray gun at even distance to object, distance should be approx. 15 cm.

## Spray pattern adjustment:

With the spray pattern adjusting screw (item 6) the spray gun can be set to spray a round or wide pattern. Use a round spray pattern for small areas, corners and edges and the wide horizontal or vertical pattern for large areas. The amount of spraying material is set with the fluid regulating screw (item 4).

Open the fluid regulating screw by approx. 2 to 2 1/2 turns and make a spray test. Additional opening of the fluid regulating screw increases fluid flow and thus the spray speed. Closing the fluid regulating screw reduces the fluid flow and the spray speed. Because of the great variety of spraying materials fluid flow adjustment should always be made when spraying.

## 6. Care and Maintenance

Thoroughly clean and service the paint spray gun after each use.

Do not use solvents containing halogenated hydrocarbon (trichlor methyl, ethyl chloride, etc.), which could resolve some of the spray gun's materials and lead to dangerous reactions.

A cleaned spray gun will perform trouble-free when used the next time.

Periodically all moving parts should be lightly oiled. If the nozzle is removed for cleaning, its threads and gasket should be greased before reassembly.

Do not use lubricants containing silicone.

Caution: Do not immerse complete spray gun in solvent!

Nozzle and valve needle are wearing parts. It is recommended you keep a replacement nozzle kit on hand (see chapter 9 „Accessories“).

Store your air tools in dry rooms only.

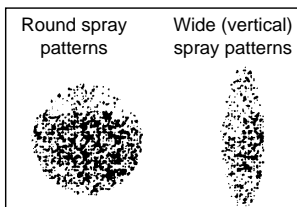

## 7. Specifications

	<b>FB 2200 HVLP</b>	<b>FB 2200</b>	<b>FB 150</b>	<b>SB 200</b>
Air consumption	100 - 200 l/min	100 - 200 l/min	150 - 260 l/min	150 - 260 l/min
Working pressure	2,6 bar	3 - 5 bar	3 - 5 bar	3 - 5 bar
Nozzle size	Ø 1.5 mm	Ø 1.5 mm	Ø 1.5 mm	Ø 1.5 mm
Flow cup	0.5 l	0.5 l	0.5 l	
Siphon cup	-	-	-	1.0 l
Weight	0.6 kg	0.6 kg	0.5 kg	0.7 kg
Weight, tool only	0.54 kg	0.54 kg	0.48 kg	0.67 kg
Recommend inner air hose diameter	9 mm	9 mm	9 mm	9 mm
Spray pattern adjustment	round & wide	round & wide	round & wide	round & wide

Pressurised air required:	clean, free of oil and condensate
---------------------------	-----------------------------------

## 8. Standard Delivery

Paint Spray Gun  
Instructions

## 9. Accessories

Nozzle Kit Ø 1.2 mm FB 2200	Stock-no. 090 105 4649
Nozzle Kit Ø 1.5 mm FB 2200	Stock-no. 090 105 4657
Nozzle Kit Ø 1.8 mm FB 2200	Stock-no. 090 105 4665
Nozzle Kit Ø 2.0 mm FB 2200	Stock-no. 090 105 4673
Nozzle Kit Ø 1.2 mm FB 150 and SB 200	Stock-no. 090 102 6858
Nozzle Kit Ø 1.5 mm FB 150 and SB 200	Stock-no. 090 102 6866
Nozzle Kit Ø 1.8 mm FB 150 and SB 200	Stock-no. 090 102 6874
Nozzle Kit Ø 2.0 mm FB 150 and SB 200	Stock-no. 090 102 6882
Other nozzle kit sizes for FB 2200 HVLP on request	

## ELEKTRA BECKUM

Ein Unternehmen der Metabo-Gruppe

- D** Elektra Beckum AG,  
Daimlerstraße 1, D-49716 Meppen  
Tel.: +49-1803-333 456, Fax: +49-1803-333 457
- A** Tel.: +49-1803-333 456, Fax: +49-1803-333 457
- AUS** Metabo Power Tools Pty. Ltd., 28 Laser Drive,  
Rowville, 3178, Victoria, Australia,  
Phone: 03 9764 1933, Fax: 03 9764 1958
- GB** Metabo UK Ltd., 25 Majestic Road, GB-SO 16 OYT  
Tel.: +44-2380-732 000, Fax: +44-2380-747 500
- F** Lurem MACHINES à BOIS,  
Zone Industriel/BP 1, F-617000 Domfront  
Tel.: +33-2-333 757 00, Fax: +33-2-333 720 70
- B** Metabo Belgium, t Hofveld 3-5,  
B-1702 Groot Bijgaarden  
Tel.: +32-2-467 32 10, Fax: +32-2-466 75 28,  
e-mail: idriesmann@metabo.be
- NL** Metabo Nederland b. v.,  
Keulsevaart 8, NL-3621 MX Breukelen,  
Postbus 180, NL-3620 AD Breukelen,  
Tel.: +31-3462-642 44, Fax: +31-3462-635 54,  
e-mail: marianne@metabo.nl
- CH** Metabo (Schweiz) AG, Kundendienst,  
Lindaustrasse 17, 8317 Tägelswangen  
Tel.: +41-52-354 34 44, Fax: +41-52-354 34 45,  
e-mail: service@metabo.ch  
www.elektra-beckum.ch
- I** Carlo Stechel & Figli S.R.L.,  
Via Buozzi 22, I-20097 San Donato Milanese (MI)  
Tel.: +39-02-556 001 11, Fax: +39-02-556 003 22,  
e-mail: a.casano@stechel.it

- E** Herramientas Metabo, S.A.,  
Poligono Ind. N°6, Parcela 16,  
E-28935 Móstoles (Madrid)  
Tel.: +34-91-616 57 67, Fax: +34-91-616 43 55,  
e-mail: metabo-madrid@accessos.es
- P** Kestra S.A. Soldadura,  
Polg. Ind. La Ferreria, C. Del Treball, No. 19,  
E-08110 Montcada I Reixac,  
Tel.: +34-935-750 030, Fax: +34-935-753 394
- P** Bolas - Máquinas e Ferramentas de Qualidade, S.A.,  
Rua 8, Lotes 8, 10, 12, P.O. Box 53,  
P-7001 Évora-Codex  
Tel.: +351-66-74 93 00, Fax: +351-66-74 93 09,  
e-mail: bolas@mail.telepac.pt
- DK** Metabo Danmark A/S,  
Manelundvej 48 C, DK-2730 Herlev  
Tel.: +44-84-13 53, Fax: +44-84-86 04,  
e-mail: brasmus@post10.tele.dk
- N** Profilma-Import A/S,  
Postboks 536 Nanset, Sophus Buggesvei 48,  
N-3252 Larvik  
Tlf.: +47-33-114 777, Fax: +47-33-114 108
- S** HDF-Paulsson AB,  
Box 525, Svaravaregatan 5, S-30180 Halmstad  
Tel.: +46-35-154 400, Fax: +46-35-121 780
- FIN** Nofa OY, P.O.Box 28,  
Hannuksentie 1, FIN-02270 Espoo  
Tel.: +358-9-804 851, Fax: +358-9-809 485
- PL** EB- Polska,  
Spółka z o.o. J.V. ul. Gdyńska 28,  
PL-73110 Stargard Szczeciński  
Tel.: +48-91-378 47 72, Fax: +48-91-578 47 72

- H** EB Negro KFT,  
Futo U. 70, HU-3508 Miskolc  
Tel.: +36-46-362 264; +36-46-366 363  
+36-30-450 618, Fax: +36-46-362 761
- AL** Extra Industrial Goods  
Rr. Fadil Rada 88, AL-Tirana  
Tel.: +355-42-330 62, Fax: +355-42-330 63
- ES** AS Mecro,  
Peturburí tee 44, EST-11415 Tallinn  
Tel.: +372-6-201 101, Fax: +372-6-201 112
- RUS** ITA Ltd.,  
Balakirevskij Pereulok 19, str. 1, RUS-Moscow  
Tel.: +7-95-737 93 11; +7-95-737 93 12,  
+7-95-737 93 13, Fax: +7-95-737 93 14,  
e-mail: ita1@online.ru
- CZ** Metabo s.r.o.,  
Kralovicka 544, CZ-25001 Brandys nad Labem  
Tel.: +42-202-804 458, Fax: +42-202-804 456,  
e-mail: Miranda@metabo.cz  
Internet: http://www.metabo.cz
- SK** Remtech Spol. S R.O.,  
Vince 293, SK-90021, Svaty Jur  
Tel.: +42-1-744 971 981, Fax: +42-1-744 971 291
- RO** Agent Trade, S. C., S.R.L.,  
Aleea Bran Nr. 2, Bl. 92, P. Ap. 47,  
RO-751552 Bucuresti 4  
Tel.: +40-13-217 445, Fax: +40-13-214 505
- SI** Dilex d.o.o.,  
Orgineva ut. 17, SLO-51113 Ljubljana  
Tel.: +386-61-168 16 20, Fax: +386-61-168 16 16