

Erbauer®



ERB20GM

2 WARRANTY
YEARS

800W MIXER



Erbauer®

Congratulations on your purchase of a quality power tool from Screwfix Direct Ltd. This product should give you reliable service but for your peace of mind this **Erbauer power tool does carry a 24-month guarantee, the terms of which are detailed below.**

If this product develops a fault within the guarantee period contact Screwfix Direct Ltd on Freephone 0500 41 41 41.

Please retain this handbook in case you need to refer to safety, care or guarantee information in the future.

GUARANTEE

This **Erbauer** product carries a Screwfix Direct Ltd guarantee of 24 months. If your product develops a fault within this period, you should, in the first instance contact Screwfix Direct Ltd on Freephone 0500 41 41 41. If the fault occurs within the first 24 months, you may return the goods for a full refund or we will repair or replace the goods if you prefer. When repair is not practical or identical goods are not available, alternative goods of similar specification and quality will usually be provided but, failing this, you will be offered a partial or full refund depending on the time period since purchase.

This guarantee specifically excludes losses caused due to:

- Fair wear and tear
- Misuse or abuse
- Lack of routine maintenance
- Failure of consumable items (such as batteries)
- Accidental damage
- Cosmetic damage
- Failure to follow manufacturer's guidelines
- Loss of use of the goods
- Repairs attempted by anyone, unless authorised by Screwfix Direct Ltd.

This guarantee does not affect your statutory rights. This guarantee is only valid in the UK.

For further technical advice and spare parts, please contact the customer helpline number on 0845 607 6380.

800W MIXER

SAFETY INSTRUCTIONS



WARNING! Read all instructions. Failure to follow all instructions listed below may result in electric shock, fire and/or serious injury.

SAVE THESE INSTRUCTIONS

1. Work area

- a. Keep work area clean and well lit.** Cluttered and dark areas invite accidents.
- b. Do not operate power tools in explosive atmospheres, such as in the presence of flammable liquids, gases or dust.** Power tools create sparks which may ignite the dust or fumes.
- c. Keep children and bystanders away while operating a power tool.** Distractions can cause you to lose control.

2. Electrical safety

- a. Power tool plugs must match the outlet. Never modify the plug in any way. Do not use any adapter plugs with earthed (grounded) power tools.** Unmodified plugs and matching outlets will reduce risk of electric shock.
- b. Avoid body contact with earthed or grounded surfaces such as pipes, radiators, ranges and refrigerators.** There is an increased risk of electric shock if your body is earthed or grounded.
- c. Do not expose power tools to rain or wet conditions.** Water entering a power tool will increase the risk of electric shock.
- d. Do not abuse the cord. Never use the cord for carrying, pulling or unplugging the power tool. Keep cord away from heat, oil, sharp edges or moving parts.** Damaged or entangled cords increase the risk of electric shock.
- e. When operating a power tool outdoors, use an extension cord suitable for outdoor use.** Use of a cord suitable for outdoor use reduces the risk of electric shock.

3. Personal safety

- a. Stay alert, watch what you are doing and use common sense when operating a power tool. Do not use a power tool while you are tired or under the influence of drugs, alcohol or medication.** A moment of inattention while operating power tools may result in serious personal injury.
- b. Use safety equipment. Always wear eye protection.** Safety equipment such as dust mask, non-skid safety shoes, hard hat, or hearing protection used for appropriate conditions will reduce personal injuries.
- c. Avoid accidental starting. Ensure the switch is in the off-position before plugging in.** Carrying power tools with your finger on the switch or plugging in power tools that have the switch on invites accidents.
- d. Remove any adjusting key or wrench before turning the power tool on.** A wrench or a key left attached to a rotating part of the power tool may result in personal injury.
- e. Do not overreach. Keep proper footing and balance at all times.** This

enables better control of the power tool in unexpected situations.

f. Dress properly. Do not wear loose clothing or jewellery. Keep your hair, clothing and gloves away from moving parts. Loose clothes, jewellery or long hair can be caught in moving parts.

g. If devices are provided for the connection of dust extraction and collection facilities, ensure these are connected and properly used. Use of these devices can reduce dust related hazards.

4. Power tool use and care

a. Do not force the power tool. Use the correct power tool for your application. The correct power tool will do the job better and safer at the rate for which it was designed.

b. Do not use the power tool if the switch does not turn it on and off. Any power tool that cannot be controlled with the switch is dangerous and must be repaired.

c. Disconnect the plug from the power source before making any adjustments, changing accessories, or storing power tools. Such preventive safety measures reduce the risk of starting the power tool accidentally.

d. Store idle power tools out of the reach of children and do not allow persons unfamiliar with the power tool or these instructions to operate the power tool. Power tools are dangerous in the hands of untrained users.

e. Maintain power tools. Check for misalignment or binding of moving parts, breakage of parts and any other condition that may affect the power tools operation. If damaged, have the power tool repaired before use. Many accidents are caused by poorly maintained power tools.

f. Keep cutting tools sharp and clean. Properly maintained cutting tools with sharp cutting edges are less likely to bind and are easier to control.

g. Use the power tool, accessories and tool bits etc., in accordance with these instructions and in the manner intended for the particular type of power tool, taking into account the working conditions and the work to be performed. Use of the power tool for operations different from intended could result in a hazardous situation.

5. Service

a. Have your power tool serviced by a qualified repair person using only Safety Instructions identical replacement parts. This will ensure that the safety of the power tool is maintained.

HEALTH ADVICE



WARNING! When drilling, sanding, sawing or grinding, dust particles will be produced. In some instances, depending on the materials you are working with, this dust can be particularly harmful to you (e.g. lead from old gloss paint).

You are advised to consider the risks associated with the materials you are working with and to reduce the risk of exposure. You should:

- Work in a well-ventilated area.

- Work with approved safety equipment, such as those dust masks that are specially designed to filter microscopic particles.

ADDITIONAL SAFETY RULES FOR YOUR MIXER

1. Always wear ear protectors with drill. Exposure to noise can cause hearing loss.
2. Always use the auxiliary handles supplied with the tool. Loss of control can cause personal injury.
3. Do not start the drill or mixing with the chuck key in chuck.
4. Make sure the power switch is not "on" before you plug in. Always switch off before you put your mixer down.
5. Hold your mixer firmly in both hands.
6. Do not use the machine in an atmosphere where there is a risk of explosion. Do not mix any solvents or substances that contain solvents with a flash point of below 21°C.
7. Do not place any cables around any parts of your body.
8. Only start and stop the machine in the mixing vessel. Ensure that the mixing vessel is placed on a firm secure base.
9. Do not reach into the mixing vessel with your hands or any other objects during the mixing process.
10. We recommend that you wear gloves and safety goggles when working with the mixing machine.
11. You must wear close-fitting clothing.
12. Always expect reaction torque.
13. When drill use clamps or a vice to hold workpiece, if possible.

Double insulation:

The tool is double insulated. This means that all the external metal parts are electrically insulated from the mains power supply. This is done by placing insulation barriers between the electrical and mechanical components making it unnecessary for the tool to be earthed.

Important note

Be sure the supply is the same as the voltage given on the rating plate. The tool is fitted with a two-core cable and plug.

Remove the mains plug from socket before carrying out any adjustment or servicing.

SYMBOLS



Read the manual



Warning



Wear gloves



Wear dust mask, eye & ear protection



Conforms to relevant safety standards

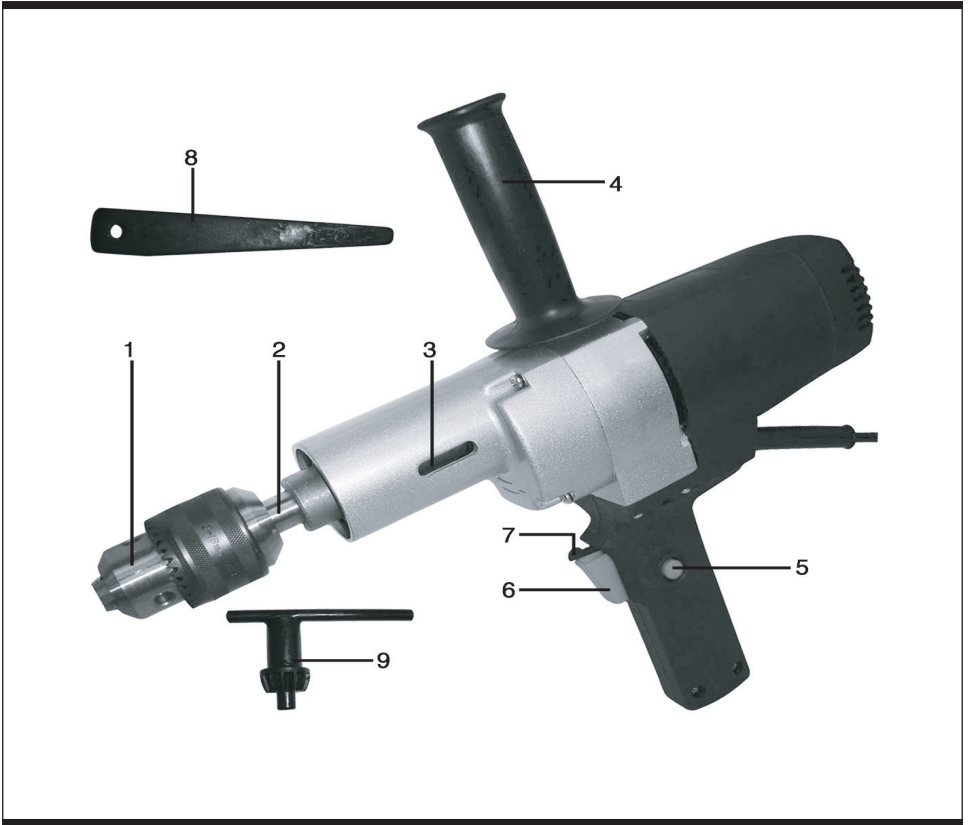

1. CHUCK

2. ADAPTER OF CHUCK

3. OPENING OF SKEW WEDGE

4. AUXILIARY HANDLE

5. SWITCH LOCK ON BUTTON

6. ON/OFF SWITCH

7. FORWARD/REVERSE SELECTOR SWITCH

8. SKEW WEDGE

9. CHUCK KEY

800W MIXER

TECHNICAL DATA

Voltage:	230V~50Hz
Power input:	800W
No load speed:	0-300min ⁻¹
Chuck capacity:	Ø3-16mm
Drilling capacity:	
Steel	Ø23mm
Wood	Ø50mm
Double insulation:	<input type="checkbox"/>
Weight:	4.20kg

NOISE AND VIBRATION DATA

Sound pressure level:	83dB (A)
Sound power level:	97dB (A)
Vibration level:	1.0m/s ²

ACCESSORIES

Auxiliary handle
Chuck key

1pc
1pc

OPERATION INSTRUCTIONS

 **Warning:** Before using your mixer be sure to read the instruction manual carefully.

1. Installing the auxiliary handle (See fig2)

For your personal safety we recommend using the auxiliary handle at all times.

To fit the handle, rotate the handle clockwise until it is secured fully.

Note: This handle should be used at all times to maintain complete control of the tool.

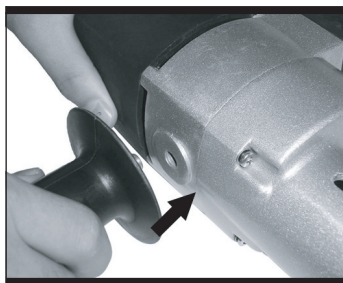

Fig 2

2. Installing the chuck (See fig3)

 **Warning: Before installing tool, remove mains plug from mains supply.**

Important: Make sure the tapered hole inside the output spindle (1) and the adapter of chuck (3) are clean and have some grease to prevent from rust.

Push the adapter of chuck into the cone of the chuck(4) forcefully. Then insert the adapter of chuck (3) into the output spindle (1), rotate the adapter of chuck until the drive key (2) engages the mating slot inside the output spindle. Push the adapter of chuck forcefully.

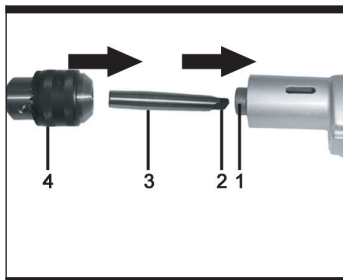

Fig 3

3. Inserting a tool into chuck (See fig4)

 **Warning: Before installing tool, remove mains plug from mains supply.**

Place the key into the chuck, turn the key anti-clockwise to undo/loosen the chuck, inset mixing tool/drill bit and firmly tighten the chuck by turning the key clockwise then remove the key.

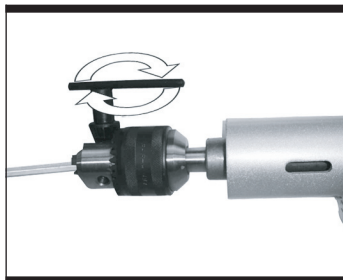

Fig 4

4. Operating the On/Off switch (see fig5)

Press the on/off switch in for operation, release switch to stop.

If you wish to use the mixer continuously the switch lock button can be pushed in after the on/off switch has been depressed. To release the lock button simply depress on/off switch fully, the button will automatically release. The speed of the mixer varies with the amount of pressure applied to the on/off switch, i.e. more pressure for higher speed.

5. Changing rotational direction (see fig6)

To change the rotational direction, push the forward/reverse selector switch to the "R" position

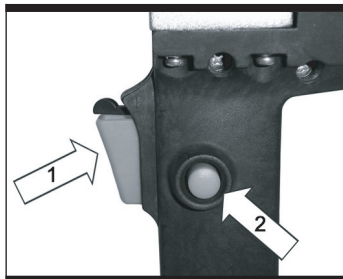

Fig 5

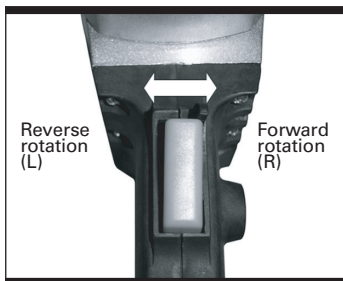

Fig 6

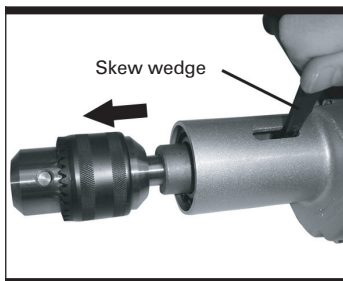

Fig 7

indicated on your mixer. The rotation will now be forward rotation. Push the forward/reverse selector switch to "L" position indicated on your mixer. The rotation will be reverse rotation.

Note:

Never change the forward/reverse selector switch whilst the mixer in operation or the on/off switch is locked as this will damage the mixer.

6. Removing the chuck (see fig7)

The adapter of chuck and chuck can be removed with a skew wedge.

1. Turn the chuck until you can see the drive key through the side opening.
2. Insert the skew wedge into the side opening.
3. Tap the skew wedge with a hammer until the adapter of chuck and chuck is released.
4. To remove the chuck from adapter of chuck, you can insert a bar into the hole of chuck. Then tap the bar with a hammer until the adapter of chuck is released.

Working hints for your mixer

1. Mixing

When you insert the mixer into the product is mixed or take it out of the product is mixed, reduce its speed. Once the mixer is fully immersed in the product, increase the speed to maximum to ensure that the motor is cooled adequately. During the mixing process guide the machine through the mixing vessel. Continue to mix the product until it is fully homogenized. When you have finished the mixing work, clean the mixer.

2. Pilot holes

When drilling a large hole in tough material (i.e. steel), we recommend drilling a small pilot hole first before using a large drill.

3. Cool the motor

If your power tool becomes too hot, set the speed to maximum and run no load for 2-3 minutes to cool the motor.

MAINTENANCE

- 1 Your power tool requires no additional lubrication or maintenance. There are no user serviceable parts in your power tool.
- 2 Never use water or chemical cleaners to clean your power tool. Wipe clean with a dry cloth.
- 3 Always store your power tool in a dry place.
- 4 Keep the motor ventilation slots clean.
- 5 If you see some sparks flashing in the ventilation slots, this is normal and will not damage your power tool.
- 6 If the supply cord is damaged, it must be replaced by a special cord or assembly available from the manufacturer or its service agent.

TROUBLESHOOTING

- 1 If your mixer will not operate, check the power at the mains plug.
- 2 If the drill is not cutting properly, check the drill bit for sharpness, replace drill bit if worn. Check that the drill is set to forward rotation for normal use.
- 3 If a fault can not be rectified return the mixer to an authorized dealer for repair.

ENVIRONMENTAL PROTECTION



Waste electrical products should not be disposed of with household waste. Please recycle where facilities exist. Check with your Local Authority or retailer for recycling advice.

PLUG REPLACEMENT

The fuse in the main plug of your power tool should always be replaced with one of identical rating.

Check the voltage given on your power tool matches the supply voltage.

The power tool is supplied with a fitted plug, however if you should need to fit a new plug follows the instruction below.

IMPORTANT

The wire in the mains lead are coloured in accordance with the following code:

Blue ---Neutral

Brown ---Live

The wire that is coloured blue must be connected to the terminal that is marked with the letter **N**.

The wire that is coloured brown must be connected to the terminal that is marked with the letter **L**.

A 13AMP (BS1363 or BS1363/A) plug must be used and a 13 AMP fuse must be fitted.

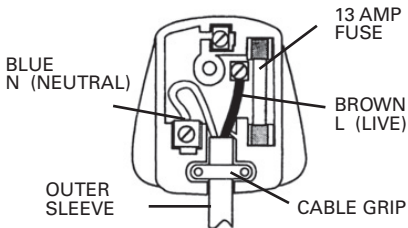

SCREWFIX DIRECT®

Declaration of Conformity

We, Importer

Screwfix Direct Ltd

Mead Avenue

Houndstone Business Park

Yeovil

BA 22 8RT

Declare that the product

800W MIXER

ERB20GM

Complies with the essential health and safety requirements of the following directives:

89/336/EEC, 93/68/EEC – EMC Directive.

73/23/EEC, 93/68/EEC – Low Voltage Directive

98/37/EC – Machinery Directive.

Standards and technical specifications referred to:

EN55014-1:2000+A1+A2

EN55014-2:1997+A1

EN61000-3-2:2000

EN61000-3-3:1995+A1

EN60745-2-1:2003

EN60745-1:2003+A1

Authorised Signatory

Date: 15/12/05

Signature: *P. C. Harries*

Name: Peter Harries
Screwfix Direct Ltd
Quality Manager



2005

800W MIXER



800W MIXER

Erbauer®