

Erbauer®

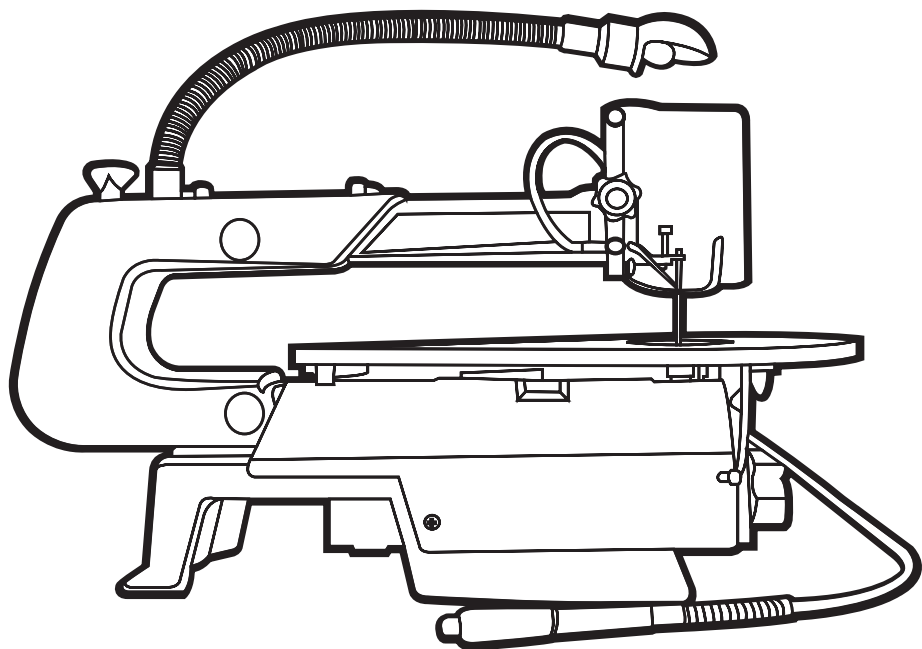

ERB110SSW

2 WARRANTY
YEARS

70W SCROLL SAW



Erbauer®

Congratulations on your purchase of a quality power tool from Erbauer (UK) Ltd. This product should give you reliable service but for your peace of mind this Erbauer power tool does carries a 24-month guarantee, the terms of which are detailed below.

If this product develops a fault within the guarantee period contact your retailer.

Please retain this handbook in case you need to refer to safety, care or guarantee information in the future.

GUARANTEE

This **Erbauer** product carries a guarantee of 24 months. If your product develops a fault within this period, you should in the first instance contact the retailer where the item was purchased.

This guarantee specifically excludes losses caused due to:

- Fair wear and tear
- Misuse or abuse
- Lack of routine maintenance
- Failure of consumable items (such as batteries)
- Accidental damage
- Cosmetic damage
- Failure to follow manufacturer's guidelines
- Loss of use of the goods

This guarantee does not affect your statutory rights. This guarantee is only valid in the UK.

For further technical advice, spare parts or repair service (outside of guarantee) please contact the customer helpline number on 0845 607 6380.

70W SCROLL SAW

SAFETY INSTRUCTIONS



Warning! When using electric tool, the following basic safety precautions should always be taken to reduce the risk of fire, electric shock and personal injury. Read all these instructions before attempting to operate the product and save these instructions for future reference.

SAVE THESE INSTRUCTIONS

1. Keep the work area clean.

Cluttered areas and benches invite injuries.

2. Consider work area environment.

Do not expose power tools to rain. Do not use power tools in damp or wet locations. Keep the work area well lit. Do not use tools in the presence of flammable liquids or gases.

3. Guard against electric shock.

Avoid body contact with earthed or grounded surfaces (e.g. pipes, radiators, ranges, refrigerators).

4. Keep children away.

Do not let persons, especially children, not involved in the work touch the tool or the extension cord and keep them away from the work area.

5. Store idle tools.

When not in use, tools should be stored in a dry, high or locked up place, out of reach of children.

6. Do not force the tool.

It will do the job better and safer at the rate for which it was intended.

7. Use the right tool.

Do not force small tools to do the job of a heavy-duty tool. Do not use tools for purposes not intended, for example, do not use circular saws to cut tree limbs or logs.

8. Dress properly.

Do not wear loose clothing or jewellery, they can be caught in moving parts. Non-skid footwear are recommended when working outdoors. Wear protective hair covering to contain long hair.

9. Use protective equipment.

Use safety glasses. Use face or dust mask if working operations create dust.

10. Connect dust extraction equipment.

If the tool is provided for the connection of dust extraction and collecting equipment, ensure these are connected and properly used.

11. Do not abuse the cord.

Never yank the tool to disconnect it from the socket. Keep the cord away from heat, oil and sharp edges.

12. Secure work.

Where possible use clamps or a vice to hold the work. It is safer than using your hand.

13. Do not overreach.

Keep proper footing and balance at all times.

14. Maintain tool with care.

Keep cutting tools sharp and clean for better and safer performance. Follow instructions for lubrication and changing accessories. Inspect tool cord periodically and if damaged have them replaced by an authorised service facility. Inspect extension cords periodically and replace if damaged. Keep handles dry, clean and free of oil or grease.

15. Disconnect tools.

When not in use, before servicing and when changing accessories such as blades, bits and cutters, disconnect tools from the power supply.

16. Remove adjusting keys and wrenches.

From the habit of checking to see that keys and adjusting wrenches are removed from the tool before turning it on.

17. Avoid unintentional starting.

Ensure switch is in the "off" when plugging in.

18. Use outdoor extension leads.

When tool is used outdoors, use only extension cords intended for outdoor use and so marked.

19. Stay alert.

Watch what you are doing. Use common sense. Do not operate tool when you are tired.

20. Check damaged parts.

Before further use of the tool, it should be carefully checked to determine that it will operate properly and perform its intended function. Check for alignment of moving parts, binding of moving parts, breakage of parts, mounting and any other conditions that may affect its operation. A guard or other part that is damaged should be properly repaired or replaced by an authorised service centre unless otherwise indicated in this instruction manual. Have defective switches replaced by an authorised service facility. Do not use the tool if the switch does not turn it on and off.



21. Warning.

The using of any accessory or attachment other than those recommended in this instruction manual may present a risk of personal injury.

22. Have your tools repaired by qualified person.

This electrical tool complies with the relevant safety requirements. Repairs should only be carried out by qualified persons using original spare parts, otherwise this may result in considerable danger to the user.

ADDITIONAL SAFETY POINTS FOR YOUR SCROLL SAWS

1. Never stand on your scroll saw.

Standing on your Scroll Saw or its stand could cause serious injury and damage to the machine. Do not store materials above or near the tool so that it is necessary to stand on the tool or its stands to reach them.

2. Check damaged parts.

If any part of the Scroll Saw is damaged, before further use, check carefully that it will operate properly and perform its intended operation. Any guard or other part that is damaged should be correctly repaired or replaced.

3. Safe working practices.

Never operate the Scroll Saw if taking medication that causes drowsiness or when having consumed alcohol or taken drugs.

It is recommended that the Scroll Saw be bolted to a bench.

4. Do not leave the scroll saw running unattended.

Turn off power to machine and unplug mains cable. Do not stop the machine with work still in contact with the blade.

5. Caution! Plugs and fuses

The Scroll Saw uses a standard amp fuse. A suitable 13-amp outlet socket should be located near the machine in accordance with electrical regulations.

6. Extension leads or reels

The Scroll Saw is fitted with a suitable electric power cable which we strongly recommend you do not extend or use an extension lead. Consult a qualified electrician on options available.

7. General description

The Scroll Saw is a static indoor machine not suitable for use outdoor.

The machine uses a single-phase alternating current 240V~50Hz. motor. Its compact and robust format makes it versatile and efficient for uses described in this manual. It complies with current regulations and the optimum quality of materials used will ensure a long working life in complete safety. Do not attempt to cut pieces of material too small to hold by hand outside the blade guard. Avoid awkward hand positions where a sudden slip could cause a hand to move into the blade.

Avoid the risk of the workpiece jumping upwards, ensure the blade teeth point downward toward the table.

To avoid blade breakage always adjust blade tension correctly.

8. To avoid losing control of the work piece or tool:

When cutting a large piece of material make sure it is fully supported at table height. Hold the work piece firmly against the table. Do not force the material while cutting. Only feed the material fast enough so that the blade maintains a smooth cutting speed. Use caution when cutting off material which is irregular in cross section, which could pinch the blade before the cut is completed. A piece of moulding for example must lay on the table and not be permitted to rock while being cut. Use caution when cutting off round material such as dowel rods or tubing . They have a tendency to roll while being cut causing the blade to bite. Use a Vblock to control the piece. When backing the blade out of the workpiece, the blade may bind in the kerf (cut) this is usually caused by sawdust clogging up the kerf. If this happens, turn off the Scroll Saw, remove plug from power source outlet, wedge open the kerf, and then back the blade out of the workpiece.

To avoid un-supervised work, misuse or accidents due to inattention: never leave the scroll saw work area with the power on or before the machine has come to a complete stop.

Do not perform layout, assembly or set up work on the table while saw is in operation. Turn the saw off and remove plug from power supply before installing or removing an accessory or attachment. Never turn your scroll saw on before clearing the table of all objects (tools scraps of wood etc) except for the work piece and related feed or support devices for the operation planned.

9. Damaged or missing parts.

Should any part of this Scroll Saw be missing, bent or fail in any way or any electrical component fail to perform properly, shut off the power switch and remove the plug from power supply.

Replace damaged, missing and/or failed parts before resuming operation.

10. Think safety.

Safety is a combination of operator common sense and alertness whenever the scroll saw is in operation. The operation of any power tool can result in foreign objects be-

ing thrown in to the eyes, which can result in severe eye damage. Always wear safety goggles before commencing power tool operation.



Warning:

Always wear safety goggles or face shield. Install blade with teeth pointing down towards the table. Keep fingers a safe distance from the blade.

Never leave the scroll saw work area with the power on. Adjust blade tension by hand (not with a tool) before turning on. Maintain control of the workpiece at all times, hold firmly against the table.

VIBRATION

The European Physical Agents (Vibration) Directive has been brought in to help reduce hand arm vibration syndrome injuries to power tool users. The directive requires power tool manufacturers and suppliers to provide indicative vibration test results to enable users to make informed decisions as to the period of time a power tool can be used safely on a daily basis and the choice of tool.

Further Advice can be found at www.hse.gov.uk

Vibration total values (triax vector sum) determined according to EN 61029:	
Work mode description 1 (with flexible shaft)	Vibration emission value $a_h = 0.14 \text{ m/s}^2$
	Uncertainty $K = 1.5 \text{ m/s}^2$

The declared vibration emission value should be used as a minimum level should be used with the current guidance on vibration.

Calculating the actual period of the actual period off use can be difficult and the HSE website has further information.

The declared vibration emission been measured in accordance with a standardised test stated above and may be used to compare one tool with another

The declared vibration emission value may also be used in a preliminary assessment of exposure.



Warning: The vibration emission value during actual use of the power tool can differ from the declared value depending on the ways in which the tool is used dependant on the following examples and other variations on how the tool is used:-

How the tool is used and the materials being cut or drilled.

The tool being in good condition and well maintained

The use the correct accessory for the tool and ensuring it is sharp and in good condition.

And the tool is being used as intended by its design and these instructions.

This tool may cause hand-arm vibration syndrome if its use is not adequately managed



Warning: identify safety measures to protect the operator that are based on an estimation of exposure in the actual conditions of use (taking account of all parts of the operating cycle such as the times when the tool is switched off and when it is running idle in addition to the trigger time). Note The use of other tools will reduce the users' total working period on this tool.

Helping to minimise your vibration exposure risk.

ALWAYS use sharp chisels, drills and blades

Maintain this tool in accordance with these instructions and keep well lubricated (where appropriate)

Avoid using tools in temperatures of 10C or less

Plan your work schedule to spread any high vibration tool use across a number of days.

Health Surveillance

All employees should be part of an employer's health surveillance scheme to help identify any vibration related diseases at an early stage, prevent disease progression and help employees stay in work.

SYMBOLS



Read the manual



Warning



WEEE marking



Wear dust mask, eye & ear protection

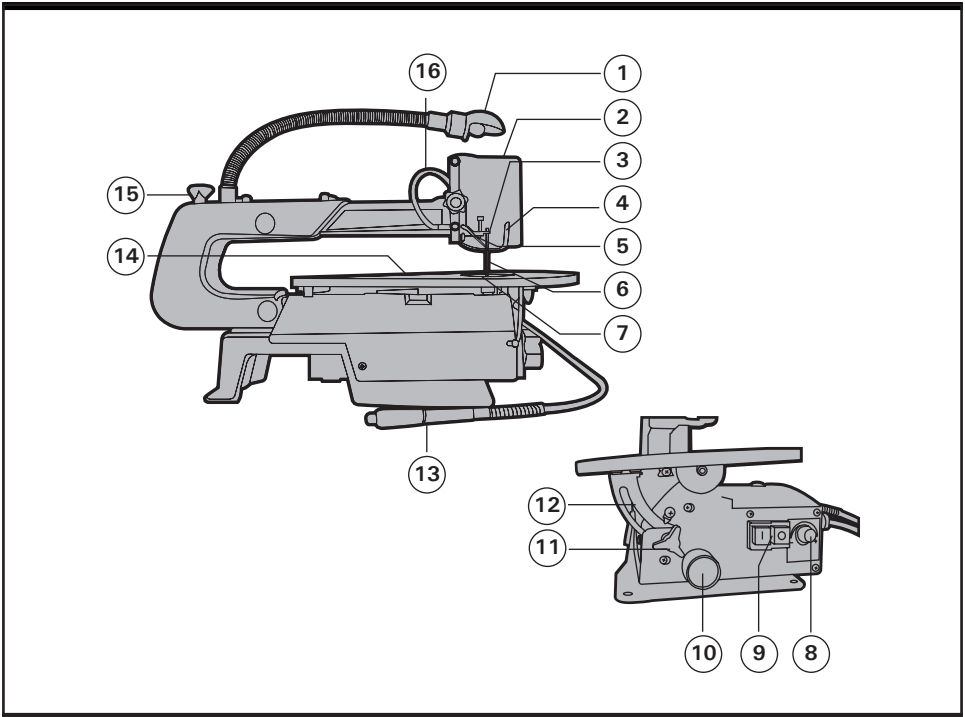

1.Adjustable light

2.Blade guard

3.Top blade holder

4.Workpiece press plate

5.Dust blower tube

6.Blade

7.Table insert

8.Blade speed regulator

9.On/Off switch

10.Dust extraction outlet

11.Table tilt lock knob

12.Angle adjustment scale

13.Flexible shaft

14.Saw table

15.Blade tension knob

16.Hose















70W SCROLL SAW

TECHNICAL DATA







Volts	230-240 V ~ 50 Hz
Rated power	70 W
Rated no load speed	550-1600 /min
Max. cutting capacity	
90°	52 mm
45°	30 mm
Depth of throat	406 mm
Table bevel	0-45°
Blade length	130 mm
Flexible shaft length	1100 mm
Flexible shaft speed	1650~4800 /min
Weight	15.5 kg

ACCESSORIES

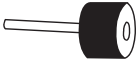
Flexible shaft including collet	1pc
Flexible shaft spindle lock	1pc
Allen key	2pcs
Wrench	1pc
Blades: 1×15TPI (2pcs), 1×18TPI (1pc)	3pcs
Blade guard	1pc
Blade holder	2pcs
kit	100pcs

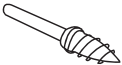
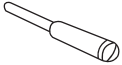
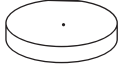
DISCRIPTION	PICTURE	SPECIFICATION	DIAMETER	QTY
Sanding band		Ø12.5X13		15
Spherical diamond cutter		Ø3	3.1	1
Spherical diamond cutter		Ø2.5	2.3	1
Diamond cutter taper		Ø3.9x6.6 Ø4.3x8.5	2.3 3.1	1 1
Twist drill bit		Ø3.2x27	3.2	1
Twist drill bit		Ø2.3x24	2.3	1
Collet chrome plated		Ø2.3-2.4	5	5
Grinding wheel		Ø9.8x10	3.1	1
Grinding wheel		Ø20x3	3.1	1
Grinding wheel		Ø10X3.4	3.1	1
Grinding wheel		Ø5.4X15	3.1	1
Steel wire brush		Ø22x2.5	3.1	1
Parabolic wheel		Ø10x15	3.1	1
Parabolic wheel		Ø10x19	3.1	1

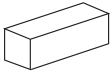
70W SCROLL SAW

Rubber wheel		Ø12.5x13.3	3.1	1
Brush axial		Ø3.5x10(PVC)	3.1	1
Mandrel for felt wheel		Ø4X7.5		1
Mandrel for cut off wheel		Ø4.5X17		1
Large felt wheel		Ø25.5x6		3
Small felt wheel		Ø13x7		5
Cut off wheel fibre glass		Ø32x1.2		8
Dressing stone SI carbide		Ø9.8x9.8x25		1
Cut off wheel grit 120		Ø24x0.6		30
Cut off wheel grit 280		Ø20.2x0.4		20

Further accessories can be purchased separately , these accessories should be suitable for small rotary tools.

OPERATING INSTRUCTIONS

 **NOTE:** Before using the tool, read the instruction book carefully.

Before using the tool, please ensure the following

- a) All covers and safety devices have been properly fitted before the machine is switched on.
- b) It must be possible for the blade to run freely.
- c) Workpieces do not contain screws, nails or other components that can come into contact with the metal blade.
- d) Before you actuate the On/Off switch, make sure that the saw blade is correctly fitted and that the machine's moving parts run smoothly.

ASSEMBLY

 **Caution!** Always disconnect the tool from the mains supply before carrying out any adjustment, servicing or maintenance.

1. Mounting the saw on a workbench (see Fig.A)

1) It is recommended that this tool is securely mounted onto a robust workbench. Fixings are not provided.

Be sure to use equipment of at least the following size:

Item	Quantity
(a) Hex screws M8	4
(b) Hex nuts M8	4
(c) Flat washer \varnothing 8 mm	4
(d) Rubber mat	1

2) We recommend that a rubber fine rib matt 420 x 250 x 3mm(minimum) 13mm (maximum) is fixed between the workbench and machine to help minimise vibrations and noise. This mat is not supplied with the product.

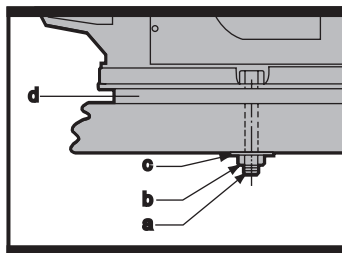

Fig.A

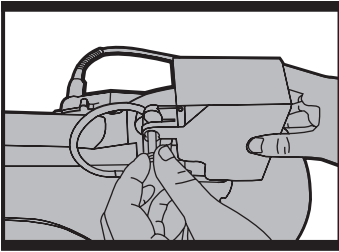

Fig.B1

Note: Do not over-tighten the screws. Leave enough scope for the foam rubber mat to develop a good absorbing effect.

2. Mounting the saw blade guard (see Fig.B1—Fig.B3)

Slide the saw blade guard (2) onto the retention bolt (e). Insert the screw through the bore hole of the retention bolt (e) and the saw blade guard (2).

(Fig.B1)

Use the nut to secure the screw from falling out.

(Fig.B2)

The saw blade guard can be fixed at various heights with the lock knob (f). **(Fig.B3)**

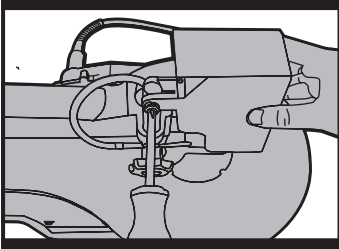

Fig.B2

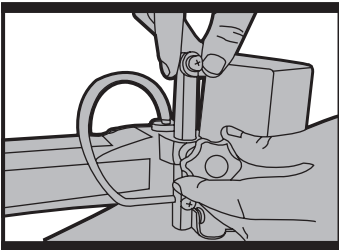

Fig.B3

3. Changing the blade (see Fig.C1 & Fig.C2)

Remove the table insert.

Turn the blade tension knob (15) anticlockwise to remove the tension from the saw blade (6).

Take the blade out of the top blade holder (3), pressing down the upper pendulum arm as you do so. Then take the blade out of the bottom blade holder.

Pull the blade up and out.

Install the new blade in reverse order.

Note: Make sure the saw blade teeth point down towards the saw table. If the teeth point upwards the workpiece will be moved upwards during the cutting action.

The blade holder has two slots to provide two blade positions. Use slot ① to cut in line with the radial arm. Use slot ② to cut at right angles to the radial arm. (Fig.C3)

Tension the blade by turning the blade tension knob (15) clockwise (right-hand thread).

Note: Do not over-tighten the knob. This will help to prolong the life of the saw blade.

4. Tilting the saw table (Fig.D)

Undo the table tilt lock knob (11). Position the table to the required angle then tighten the lock knob to secure.

Important: For precision work you should first carry out a trial cut and then re-adjust the tilt angle as required.

After completing sawing on the tilted saw table return to the horizontal flat position by undoing the table tilt lock knob (11) and positioning at 0 degrees on the scale.

For precise work always double check the angle of the work bench with a protractor or similar angle measure.

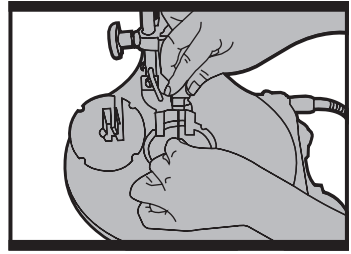

Fig.C1

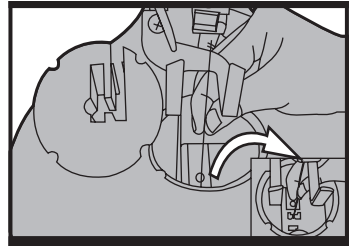

Fig.C2

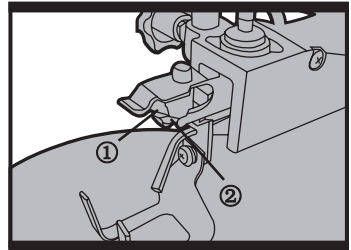

Fig.C3

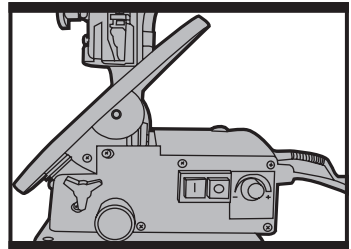

Fig.D

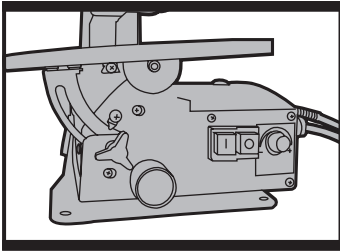

Fig.E

OPERATION

Note:

- 1) Your saw does not cut wood automatically. You have to guide the wood against the blade for operation.
- 2) When cutting thick timber or hardwood, be particularly careful not to bend or twist the blade. This will help to prolong blade life.
- 3) Do not assemble the flexible shaft when sawing, otherwise the shaft will damage the spring.

1. On / Off switch (9) (see Fig.E)

To start the machine, press the on/off switch to ON position ("I"). To stop, press the switch to OFF position ("O").

Note: The machine is equipped with a magnetic switch to prevent it being switched on again accidentally after a power failure.

2. Blade speed regulator (8) (see Fig.E)

The blade speed regulator allows you to set the blade speed appropriate to the material to be cut.

3. Carrying out internal cuts

- 1) To carry out internal cuts in a panel, firstly remove the blade.
- 2) Drill a 6.3mm hole inside the boundary of the aperture to be cut from the panel.
- 3) Place the panel on the saw table with the drilled hole above the blade access hole.
- 4) Install the blade through the hole in the panel and adjust the blade tension.
- 5) When you have completed the internal cuts, remove the blade from the blade holders and take the panel off the table.

4. Adapter for saw blades

a) Attaching the blade adaptors to plain end blades

Adjust one setscrew on each adaptor until it covers approximately half the hole. **(Fig.F1)**

Loosen the other setscrew just enough to slide one adaptor onto each end of the blade (6) as shown. **(Fig.F2)**

Place the blade and adaptors into the gauge to set the blade to the proper length as shown in **(Fig.F3)**.

b) Attaching the blade adaptors to plain end blades for side cutting **(Fig.F4)**

a. Remove both setscrews from each blade adaptor, thread them into the opposite holes in the blade adaptor perpendicular to the adjustment pin, and repeat steps above with the blade in the side cutting position.

b. Cutting from the side of the saw will be necessary when your workpiece exceeds 405mm in length. With the blade positioned for side cutting, the table must always remain in the 0° bevel position.

WARNING: Do not attempt to cut a bevel with the blade positioned for side cutting.

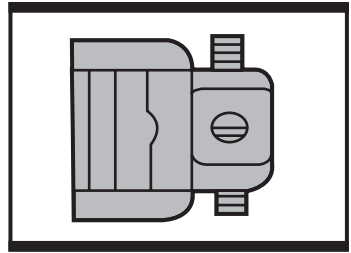

Fig.F1

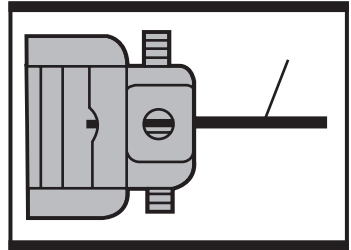

Fig.F2

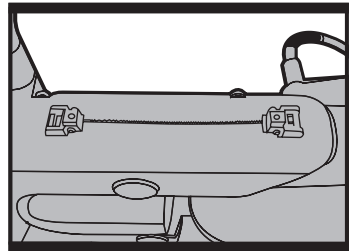

Fig.F3

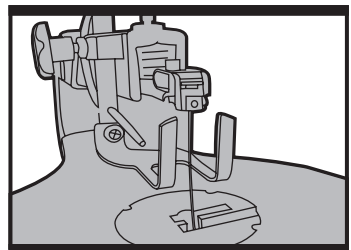

Fig.F4

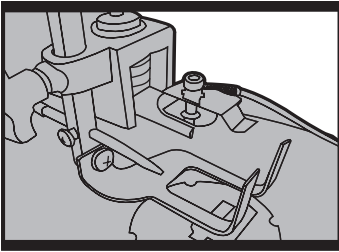

Fig.G

5. Using the dust blower tube (see Fig.G)

Align the dust blower tube (5) towards the saw blade to blow sawdust away from the sawblade cutting line.

6. Installing the flexible drive shaft (see Fig.H1—Fig.H4)

Disconnect from mains supply and ensure machine is switched off.

Remove the cover from flexible shaft drive aperture. **(Fig.H1 & Fig.H2)**

Insert the flexible drive shaft into the aperture.

Fitting accessories to the flexible shaft.

Insert the spindle lock (g) into the hole situated in the handle of the flexible shaft. Turn the collet nut until the spindle lock engages and prevents the shaft rotating. **(See Fig.H3)**. Insert the required accessory and tighten the collet with the wrench provided. **(See Fig.H4)**

Remove the spindle lock.

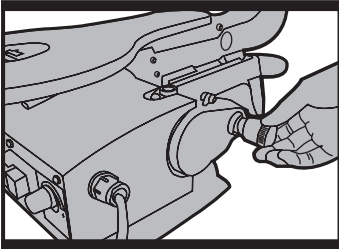

Fig.H1

● OPERATING THE FLEXIBLE SHAFT

Follow these guidelines when operating the tool.

Always allow the tool to operate as it was designed. Never force the flexible shaft.

Secure the workpiece to prevent movement.

Hold the tool tightly and keep it a safe distance from other persons. Always point the bit away from your body.

Slow speed is best for polishing operations, delicate woodcarving, or working on fragile model parts. High speed is suitable for operation on hardwoods, metals and glass, such as: carving, routing, shaping, cutting and drilling.

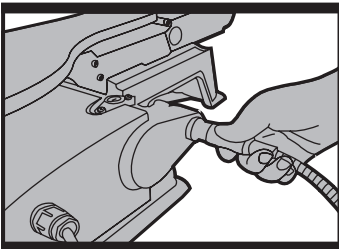

Fig.H2

⚠ WARNING:

To avoid risk of injury please ensure the blade guard is assembled and positioned over the saw blade when using the flexible shaft.

● AFTER OPERATION

Do not touch the moving part when the flexible shaft is just switched off.

Do not put down your tool before the working head stops rotating.

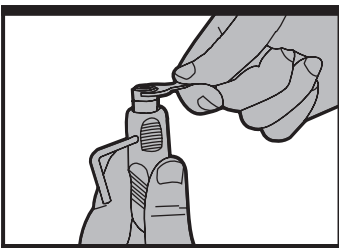

Fig.H3

MAINTENANCE

Remove the plug from the socket before carrying out any adjustment, servicing or maintenance.

1. Cleaning

There are no user serviceable parts in your power tool. Never use water or chemical cleaners to clean your power tool. Wipe clean with a dry cloth. Always store your power tool in a dry place. Keep the motor ventilation slots clean. Keep all working controls free of dust. Occasionally you may see sparks through the ventilation slots. This is normal and will not damage your power tool.

2. Lubrication

Arm Bearings - Lubricate the arm bearings with oil after 10 hours of use. Re-oil after every 50 hours of use or whenever there is a squeak coming from the bearings.

To Lubricate:

Turn saw on its side.

Squirt a generous amount of SAE 20 oil around the shaft end and bronze bearing. **(See Fig.1)**

Let the oil soak in overnight in this condition.

Next day repeat the above procedure for the opposite side of the saw.

If the supply cord is damaged, it must be replaced by the manufacturer, its service agent or similarly qualified persons in order to avoid a hazard.

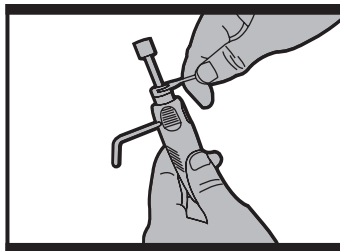

Fig.H4

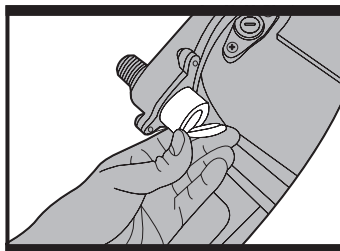

Fig.1

ENVIRONMENT PROTECTION



Waste electrical products should not be disposed of with household waste. Please  recycle where facilities exist. For further information visit www.recycle-more.co.uk

PROBLEM	CAUSE	SOLUTION
Motor will not run.	<ol style="list-style-type: none"> 1. Problem with power cord or outlet. 2. Motor defective. 	<ul style="list-style-type: none"> -Check the plug fuse. Check power at mains supply socket. -Do not attempt any repair. -Have it repaired by a qualified service technician.
Blades breaking.	<ol style="list-style-type: none"> 1.Tension too high. 2.Feeding too quickly. 3.Wrong blade. 4.Blade twisting in wood. 	<ul style="list-style-type: none"> -Adjust tension. -Reduce feed rate. -Use narrow blades for cutting thin wood, tight corners and curves. Use wide blades for thicker wood and large curves. -Reduce side pressure on blade, check blade tension.
Vibration (there is always a certain amount of vibration when the saw is running)	<ol style="list-style-type: none"> 1. Improper mounting of saw. 2. Improper bracing. 3. Loose table or table resting against motor. 4. Loose motor mounting. 	<ul style="list-style-type: none"> -Check mounting. -Check saw mounting instructions. -Tighten table lock knob. -Tighten motor mounting screws.
Blade runout (blade not properly aligned with arm motion).	<ol style="list-style-type: none"> 1. Blade holders out of line. 	<ul style="list-style-type: none"> -Realign blade holders and blade.

PLUG REPLACEMENT

The fuse in the main plug of your power tool should always be replaced with one of identical rating.

Check the voltage given on your power tool matches the supply voltage.

The power tool is supplied with a fitted plug, however if you should need to fit a new plug follows the instruction below.

IMPORTANT

The wire in the mains lead are coloured in accordance with the following code:

Blue ---Neutral

Brown ---Live

The wire that is coloured blue must be connected to the terminal that is marked with the letter N.

The wire that is coloured brown must be connected to the terminal that is marked with the letter L.

A 13 AMP (BS1363 or BS1363/A) plug must be used and a 10 AMP fuse must be fitted.

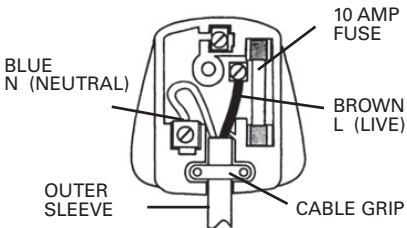

Erbauer®

Declaration of Conformity

We, Importer
Erbauer (UK) Ltd BA22 8RT

Declare that the product
70W SCROLL SAW
ERB110SSW

Complies with the essential health and safety requirements of the following directive:

Machinery Directive **98/37/EC**

Low Voltage Directive **2006/95/EC**

Electromagnetic Compatibility Directive **2004/108/EC**

Restrictions of the Use of Certain Hazardous Substances in Electrical and Electronic Equipment **2002/95/EC**

Standards and technical specifications referred to:

EN 61029-1: 2000/+A11: 2003+A12: 2003

EN 55014-1:2000/+A1: 2001+A2: 2002

EN 55014-2: 1997/+A1: 2001

EN 61000-3-2:2000+A2:2005

EN 61000-3-3: 1995+A1:2001+A2:2005

Authorised Signatory

Date: 01/03/08

Signature: P. C. Harries

Name: Peter Harries
Erbauer (UK) Ltd
Quality Manager



2008



Erbauer®