

Byron™ Portable Wire Free Chime Kit

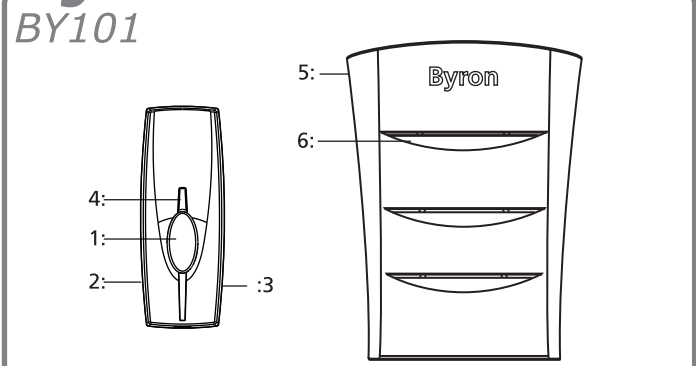

- 1: Push Button
- 2: Melody Selector
- 3: Bell Push Battery
- 4: Signal Sent LED
- 5: Portable Chime
- 6: Speaker

Setup:

1

- Place a small flat screwdriver into the locking clip on the base of the Bell Push.
- Gently twist.
- The backing plate will unclip.

2

- Insert CR2032 battery (Supplied) into the battery holder.
- Make sure the positive side is facing upwards.
- Replace back plate.

Warning: Make sure that the batteries are replaced correctly to avoid battery failure. Only replace with same or equivalent type.

3

- Remove the battery cover of the Door Chime.
- Insert 3 X 1.5V Size 'AA' batteries (Not Supplied).
- Make sure the Positive/Negative terminals match the internal markings.

3 x 1.5V 'AA'

4

- The Chime will 'Beep Beep'.
- Press the Bell Push within 60 seconds to learn the Bell Push to the chime.
- The Chime Will Ring to confirm setup.
- Replace the battery cover.

Note: Maximum of 2 Bell Pushes can be learnt to a single Chime for Front/Back Door use.

Functions: Melody Selection:

To select a melody for the Door Chime

- Remove the Back Plate from the Bell Push
- Press the Melody Select button.
- The chime will play the newly selected sound
- Press again to select the next melody.

Note: For Front/Back door setup, select a different melody in one of the Bell Pushes.

4 Selectable Melodies

- 1: Ding Dong (Repeat)
- 2: Westminster
- 3: Alarm
- 4: Ding Dong Ding

Adding Additional Chime/Bell Push:

- 1:**
- 2:**
- 3:**

Additional Chime
To add an additional Chime unit to the Door Chime kit

- Remove the batteries on your NEW Door Chime and wait for 10 seconds.
- Replace the batteries, making sure the Positive/Negative terminals match the internal markings.
- The Chime will 'Beep Beep' to indicate that it has entered the Learn mode.
- Press the Bell Push within 60 seconds, to pair the additional Chime to the Bell Push.
- Chime will ring to confirm setup, wait 60 seconds for the Chime to exit the learn mode before repressing the Bell Push.

Additional Bell Push
To add an additional Bell Push to the Door Chime kit

- Remove the batteries on your Door Chime and wait for 10 seconds.
- Replace the batteries, making sure the Positive/Negative terminals match the internal markings.
- The Chime will 'Beep Beep' to indicate that it has entered the Learn mode.
- Press the both Bell Push within 60 seconds, to pair the additional Bell Push to the Chime.
- Chime will ring to confirm setup, wait 60 seconds for Chime to exit the learn mode before repressing the Bell Push. For Front/Back door setup, select a different melody in one of the Bell Pushes - See Melody Selection.

Note: Maximum of 2 Bell Pushes can be learnt to a single Door Chime.

Front Door

1

Back Door

2

Installation Guide:

1  **Avoid** locating the Bell Push/Chime on or directly near metallic surfaces as this may reduce the operation range.
UPVC Door Frames:
 When locating the bell push onto a UPVC door, always check the operating performance before final installation, internal metal frame may affect performance.
Note: Try adjusting the location of the Bell Push to the Left/Right or place on external wall.

Installation Guide: Bell Push

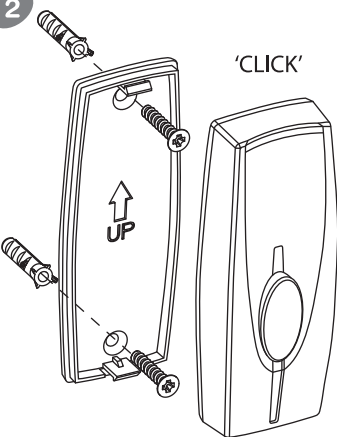
2 

- Using back plate as a template
- Making sure UP arrows points UP.
- Mark and drill holes.
- Insert wall plugs and attach to wall using screws provided.
- Clip the Bell Push on to the back plate making sure the Bell Push 'Clicks' in to place.

Note: The Bell Push can be installed using a suitable double sided adhesive tab or tape when drilling is not suitable.

Changing Batteries:

Bell Push:

- Remove back plate from the Bell Push
- Remove old battery from the holder
- Replace with new 'CR2032' 3V battery
- Insert into holder making sure '+' is facing up
- Test Chime Kit

1 x 3V CR2032

Chime Unit

- Remove Batteries.
- Insert new batteries, 3 X 1.5V size 'AA'
- Make sure Positive/Negative match the internal markings
- Wait 60 seconds before testing the Chime Kit.

3 x 1.5V 'AA' *Always dispose of old batteries in an environmentally friendly way.*

User Hints:
 In case of the door chime does not sound, please check the followings:

- Flat batteries in either Push Button or Door Chime.
- Wrong battery polarity in either Push Button or Door Chime.
- For Plug-in Door Chimes make sure the socket is switched on.
- Bell Push and Door Chime are not paired together, see setup guide.
- Materials in between the Bell Push & Chime will reduce the operating range, move the Door Chime closer to the Bell Push
- Wire free devices can be affected by external sources e.g. wire free home alarms or power transformers/adapters

Installation Guide: Chime

3 Place the door Chime within the operating range, transmission of the wire free signal through Walls, Doors and Ceilings etc, may reduce the operating range. Chime unit for INDOOR use only.

Range Guide

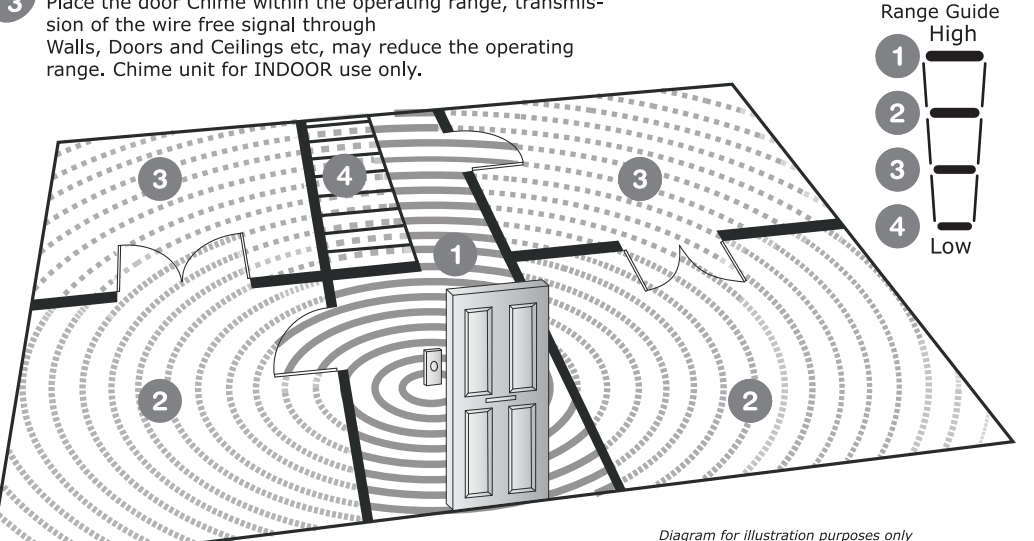

1 High
2
3
4 Low



Diagram for illustration purposes only



Type R2 Device - device where the sound output is created by the initial operation of the control and where the period of sound output continues for the designed duration irrespective of condition of the control.

IMPORTANT:

There are no serviceable parts, do not repair. The appliance is not to be used by children or persons with reduced physical, sensory or mental capabilities, or lack of experience and knowledge, unless they have been given supervision or instruction. Children should be supervised to ensure that they do not play with the appliance.

Specification

IP44   Bell Push: BYT Power: 1 x CR2032 3V DC Battery (Included) IP44 Weather Resistant

  Portable Door Chime: BY101 Power: 3 x 'AA'/LR6 1.5V Batteries Range: 50 Metres Indoor Use Only



 Tel: 0845 2301231 (UK)
 9-5 Mon-Fri, Local call charges apply

 support@chbyron.com

 <http://www.chbyron.com>

 GB: CH Byron
 Byron House, Sherwood Rd
 Astonfields, Bromsgrove
 B60 3DR
 UK

Byron		433.92MHz									
R&TE APPROVED 											
A	▲	IRL	▲	UK	▲	BG	▲	M	▲	N	▲
B	▲	I	▲	EST	▲	CZ	▲	SK	▲	SI	▲
DK	▲	FIN	▲	NL	▲	H	▲	CH	▲		▲
F	▲	D	▲	E	▲	IS	▲	PL	▲		▲
GR	▲	P	▲	S	▲	LV	▲	RO	▲		▲
LT	▲		▲		▲		▲		▲		▲

CH Byron Electrical United Kingdom. www.chbyron.com