





Technical Data

Supply Voltage:	220-240 V~ 50 Hz
Bulb Type:	Non-replaceable 40W LED (See rating / box info)
	The light source contained in this luminaire shall only be replaced by the manufacturer or his service agent or a similar qualified person
	Conformity with all relevant EC Directive requirements.
	Class I product, must be connected to earth.
IP44	Protects against solid objects over 1mm and sprays from all directions. Limited ingress permitted.
	Waste electrical products should not be disposed of with household waste. Please recycle where facilities exist. Check with your Local Authority or local store for recycling advice.

STANLEY®

SXLS31322E - 240V

40W Plasterers Worklight Instruction Manual

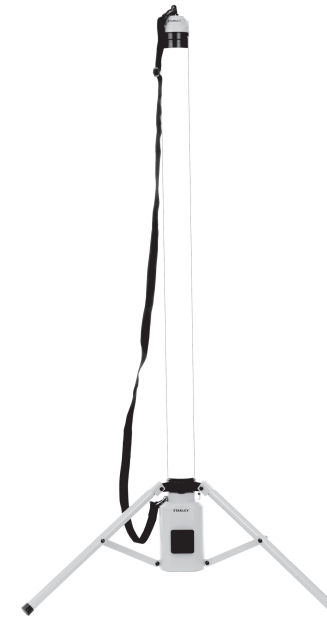

CE

STANLEY

STANLEY

REGISTERED TRADEMARKS

Stanley, The Stanley Logo, The Notched Rectangle and the Yellow and Black Diagonal Package Design are all trademarks of Stanley Black & Decker, Inc or an affiliate thereof and are used under license. Product manufactured and distributed by Cascade Holdings Ltd., Gorse Mill, Gorse Street, Chadderton, Oldham, Lancashire, OL9 9RJ

SAVE THIS INSTRUCTION MANUAL FOR FUTURE REFERENCE

Made in China

CHL OL9 9RJ

Customer Service: 0333 005 0077

READ ALL INSTRUCTIONS

Safety

- These instructions are for your safety. Please read through them thoroughly prior to installation and retain them for future reference.
- Always organise cables and extension leads so that they will not be a trip hazard
- If the external flexible cable or cord of this Luminaire is damaged, it must only be replaced by a qualified electrician to avoid any electrical hazards.
- Check the pack and make sure you have all of the parts listed.
- Remove all packaging, wrap etc. from the product.
- Decide on the appropriate location for your product.
- IP44 product: Protects against solid objects over 1mm and sprays from all directions, Limited ingress permitted.
- Always refer to the installation drawing for the orientation of the product.
- Never put anything on the product or hang anything on any part of this product.
- When the product does not light after installation:
 - > Ensure there is no electricity failure
 - > Ensure all the connections are secured
- Always disconnect the product from mains at least 10 minutes allowing to cool down before any maintenance or adjustment.
- **CAUTION:** Do not stare at the operating LED light source.

Cleaning care

- The lamp can be cleaned with a clean dry cloth. Do not immerse it in water.
- Always switch off the supply before cleaning

Parts Supplied

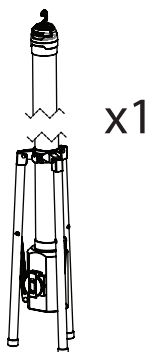

Installation Instructions

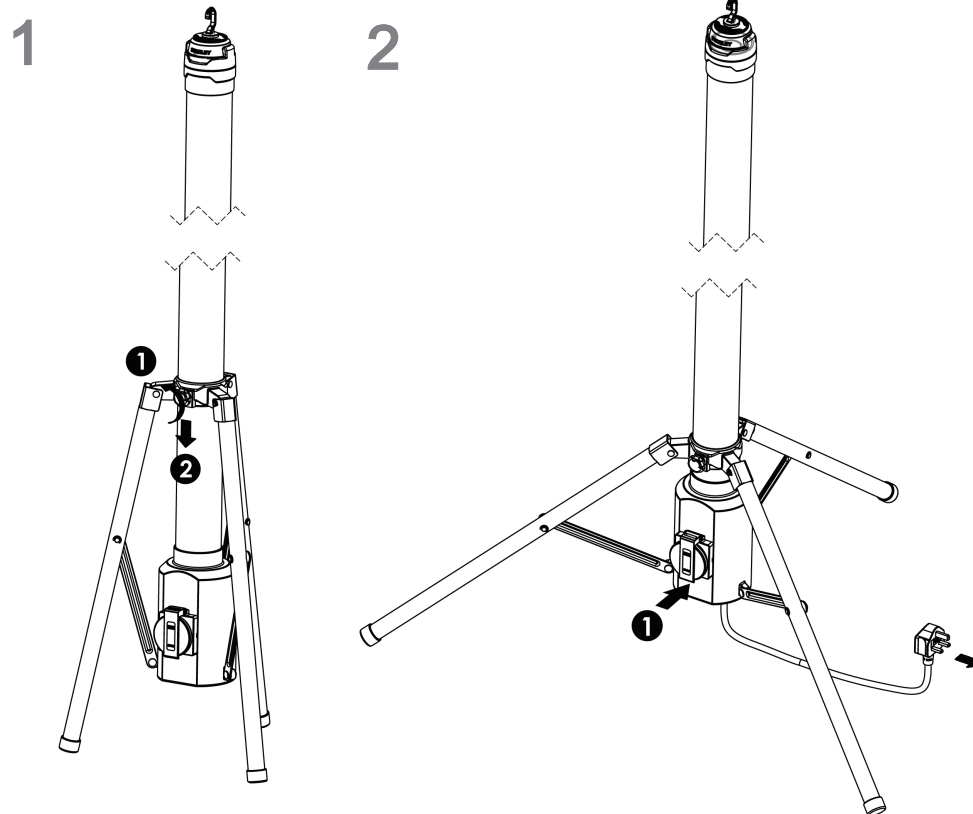

Images for illustration purposes only – Product may differ slightly from the one shown