



Petrol 40cm Scarifier & Aerator

WEPLS400P

1938264001

en - Original Instructions

ASSEMBLY REQUIRED
Minimum Two Persons

Sales & Support: 01793 333212

Before use please read & understand this manual; paying particular attention to the safety instructions before use.
Incorrect use of the product could put the operator or machine in danger.
Whilst every effort has been made to ensure the accuracy of information contained in this manual, our policy of continuous improvement determines the right to make modifications without prior warning.
Images are used for illustration purposes only.



INSTRUCTION MANUAL

2 Jul 2020

Copyright Notice

Copyright © Handy Distribution

Permission is granted to reproduce this publication for personal & educational use only.
Commercial copying, redistribution, hiring or lending is prohibited.

No part of this publication may be stored in a retrieval system or transmitted in any other form or means without written permission from Handy Distribution.

In all cases this copyright notice must remain intact.

CONTENTS

- INTENDED USE
- SAFETY INSTRUCTIONS
- SPECIFICATIONS
- KNOW YOUR MACHINE
- ASSEMBLY
- PRE-OPERATION
- OPERATION
- MAINTENANCE, CLEANING & STORAGE
- TROUBLE SHOOTING
- PARTS DIAGRAM & LIST
- DECLARATION OF CONFORMITY
- WARRANTY

INTENDED USE

The basic version of the equipment is a walk behind petrol scarifier & aerator intended for private use, i.e. for use in home and gardening environments. It is designed to rip out moss and weeds - complete with their roots out of the soil and for loosening the soil in medium to large lawns. As a result, your lawn can absorb nutrients better and is cleansed. We recommend you scarify your lawn in the spring (April) and autumn (October). The scarifier/aerator is for private use, whose annual operating time generally does not exceed 50 hours. Public facilities, sporting halls, and agricultural / forestry applications are excluded. Please read this entire manual prior to operating the equipment. It instructs you how to safely and easily set up, operate and maintain your machine. Please be sure that you, and any other persons who will operate the machine, carefully follow the recommended safety practices, at all times. Failure to do so could result in personal injury or property damage.

TO THE OWNER

All information in this manual is relative to the most recent product information available at the time of printing. Review this manual frequently to familiarise yourself with the machine, its features and operation. Please be aware that this Instruction Manual may cover a range of product specifications for various models. Characteristics and features discussed and/or illustrated in this manual may not be applicable or exact to all models.

We reserve the right to change product specifications, designs and equipment without notice and without incurring obligation. If you have any problems or questions concerning the machine, phone your local authorised service dealer or ourselves. Throughout this manual, all references to *right* and *left* side of the machine are observed from the operating position



WARNING



For safety reasons, the scarifier/aerator may not be used as a drive unit for other equipment or toolkits of any kind, unless specifically advised to do so by the manufacturer. The equipment is to be used only for its prescribed purpose. Any other use is deemed to be a case of misuse. The user/operator and not the manufacturer will be liable for any damage or injuries of any kind caused as a result of this.

Please note that our equipment has not been designed for use in commercial, trade or industrial applications. Our warranty will be 90 days from the original date of sale for commercial, trade or industrial businesses or for equivalent purposes.

INSTRUCTION MANUAL

SAFETY INSTRUCTIONS

Read and understand the owner's manual and labels affixed to the machine. Learn its application and limitations as well as the specific potential hazards. Retain these instructions for future reference. The operator is responsible for following the warnings & instructions in this manual and on the product.

	<p>Read & understand operator's manual before using the machine. Failure to follow instructions could result in death or serious injury. Please keep in a safe place for future reference.</p>		<p>Always wear safety eye and ear protection when operating this machine.</p>
	<p>DANGER Keep all bystanders & animals away from the machine during operation. If approached, stop the machine immediately.</p>	 	<p>Always wear gloves to protect your hands. Wear foot protection or sensible shoes when using the machine</p>
	<p>WARNING — CARBON MONOXIDE Never run an engine indoors or in a poorly ventilated area. Engine exhaust contains carbon monoxide, an odorless and deadly gas.</p>		<p>DANGER — THROWN DEBRIS Remove objects that can be thrown by the machine in any direction.</p>
	<p>DANGER – SLOPES Use extra caution on slopes. Do not trim on slopes greater than 15°.</p>		<p>Always remove the spark plug lead from the spark plug before performing any maintenance, inspection or repair.</p>
	<p>WARNING — PETROL IS FLAMMABLE Allow the engine to cool at least two minutes before refueling.</p>		<p>Do not expose to rain or damp conditions.</p>
	<p>No smoking</p>		<p>Do not use near a flame, or sparks</p>
	<p>WARNING— HOT SURFACE Engine parts, especially the muffler, become extremely hot during operation. Allow engine and muffler to cool before touching.</p>		<p>DANGER — SHARP TINES Keep hands and feet away from rotating parts</p>
	<p>Keep guards in place and in working order. Replace damaged, missing or failed parts before using it.</p>		<p>Safety alert symbol. Used to alert you to potential personal injury hazards. Obey all safety messages that follow this symbol to avoid possible injury.</p>
 DANGER	<p>Indicates an imminently hazardous situation which, if not avoided, will result in serious injury</p>	 WARNING	<p>Indicates a potentially hazardous situation which, if not avoided, could result in serious injury</p>
 CAUTION	<p>Indicates a potentially hazardous situation which, if not avoided, may result in minor or moderate injury.</p>	<p>CAUTION</p>	<p>Used without the safety alert symbol indicates a potentially hazardous situation which, if not avoided, may result in property damage.</p>
	<p>CE Marking - the product meets demand and regulations set by the EU</p>		<p>Noise Level - See label on machine</p>

GENERAL SAFETY RULES



WARNING

Before you put the machine into operation, you must read this instruction manual.

When using this machine, observe the following safety instructions to exclude the risk of personal injury or material damage. Please also observe the special safety instructions in the respective chapters. Where applicable, follow the legal directives or regulations for the prevention of accidents in relation to the use of this machine.

When using petrol tools, basic safety precautions, including the following, should always be followed to reduce the risk of serious personal injury and/or damage to the unit.

GENERAL OPERATION

1. Read this instruction manual carefully in its entirety before attempting to assemble this machine. Read, understand, and follow all instructions on the machine and in the manual(s) before operation. Keep this manual in a safe place for future and regular reference and for ordering replacement parts.
2. Be completely familiar with the controls and the proper use of this machine before operating it.
3. This machine is a precision piece of power equipment, not a plaything. Therefore, exercise extreme caution at all times. This machine has been designed to perform one job: to cut out moss and weeds from the root. Do not use it for any other purpose.
4. Never allow children under 16 years of age to operate this machine. Children 16 and over should read and understand the instructions and safe operation practices in this manual and on the machine and should be trained and always supervised by an adult.
5. Only responsible individuals who are familiar with these rules of safe operation should be allowed to use this machine.
6. Thoroughly inspect the area where the equipment is to be used. Remove all stones, sticks, wire, bones, toys and other foreign objects, which could be tripped over or picked up and thrown by the scarifier. Thrown objects can cause serious personal injury.
7. Plan your scarifying pattern to avoid discharge of material toward roads, pathways, bystanders and the like. Also, avoid discharging material against a wall or obstruction, which may cause discharged material to ricochet back toward the operator.
8. To help avoid tine contact or a thrown object injury, stay in operator zone behind handles and keep children, bystanders, helpers and pets at least 20 metres from scarifier while it is in operation. Stop machine if anyone enters area.
9. Always wear safety glasses or safety goggles during operation and while performing an adjustment or repair to protect your eyes. Thrown objects which ricochet can cause serious injury to the eyes.
10. Wear sturdy, rough-soled work shoes and close-fitting trousers and shirts. Shirts and trousers that cover the arms and legs and steel-toed shoes are recommended. Never operate this machine in bare feet, sandals, slippery or light-weight (e.g. canvas) shoes.
11. Do not put hands or feet near or under rotating parts. Always keep clear of discharge area, as the rotating tines can cause injury.
12. Never operate the scarifier without proper shields, guards, control lever or other safety protective devices in place and working.
13. Never operate the scarifier with damaged safety devices. Failure to do so, can result in personal injury.
14. Many injuries occur as a result of the tines being pulled over the foot during a fall caused by slipping or tripping. Do not hold on to the scarifier/aerator if you are falling; release the handle immediately.
15. Never pull the scarifier back towards you while you are walking. If you must back the scarifier away from a wall or obstruction, first look down and behind to avoid tripping and then follow these steps:
 - A. Step back from the scarifier/aerator to fully extend your arms.
 - B. Be sure you are well balanced with sure footing.
 - C. Pull the scarifier/aerator back slowly, no more than halfway towards you.
 - D. Repeat these steps as needed.



INSTRUCTION MANUAL

16. Do not operate the scarifier while under the influence of alcohol or drugs.
17. The OPC/Brake lever is a safety device. Never attempt to bypass its operation. Doing so makes the safety device inoperative and may result in personal injury through contact with the rotating tines. The control lever must operate easily in both directions and automatically return to the disengaged position when released.
18. Never operate the scarifier in wet grass. Always be sure of your footing. A slip and fall can cause serious personal injury. If you feel you are losing your footing, release the OPC/Brake lever immediately and the spindle will stop rotating within three seconds.
19. Operate only in daylight or good artificial light. Walk, never run.
20. Stop the tines when crossing gravel drives, paths or roads.
21. If the machine starts to vibrate abnormally, stop the engine and check immediately for the cause. Vibration is generally a warning of trouble.
22. Shut the engine off and wait until the spindle comes to a complete stop before cleaning the discharge area. The tines continue to rotate for a few seconds after the OPC/Brake lever is released. Never place any part of the body in the scarifier area until you are sure the tines have stopped rotating and the spark plug cap removed from the spark plug and contact cannot be made between the two.
23. Never operate the scarifier without proper shields, discharge cover, OPC/Brake lever or other safety protective devices in place and working. Never operate with damaged safety devices. Failure to do so can result in personal injury.
24. Muffler and engine can become hot and cause burns. Do not touch!
25. Only use parts and accessories made for this machine by the manufacturer. Failure to do so can result in personal injury.
26. When starting the engine, pull cord slowly until resistance is felt, then pull rapidly. Rapid retraction of starter cord (kickback) will pull hand and arm towards engine faster than you can let go. Broken bones, fractures, bruises or sprains could result.
27. If situations occur which are not covered in this manual, use care and good judgement. Contact your nearest Approved Service Dealer for assistance

SLOPE OPERATION

Slopes are a major factor related to slip and fall accidents, which can result in severe injury. Operation on slopes requires extra caution. If you feel uneasy on a slope, or it is greater than 15 degrees, do not scarify on it.

Do:

1. Scarify across the face of slopes; never up and down. Exercise extreme caution when changing direction on slopes.
2. Watch for holes, ruts, rocks, hidden objects, or bumps which can cause you to slip or trip. Tall grass can hide obstacles.
3. Always be sure of your footing. A slip and fall can cause serious personal injury. If you feel you are losing your balance, release the OPC/Brake lever immediately and the tines will stop rotating within three (3) seconds.

Do Not:

1. Do not scarify near drop-offs, ditches or embankments, you could lose your footing or balance.
2. Do not scarify on slopes greater than 15 degrees.
3. Do not scarify on wet grass. Unstable footing could cause slipping.

CHILDREN

Tragic accidents can occur if the operator is not alert to the presence of children. Children are often attracted to the scarifier and the activity. They do not understand the dangers. Never assume that children will remain where you last saw them.

1. Keep children out of the scarifying area and under care of a responsible adult other than the operator.
2. Be alert and turn the scarifier off if a child enters the area.
3. Before and while moving backwards, look behind and down for small children.
4. Use extreme care when approaching blind corners, doorways, shrubs, trees, or other objects that may obscure your vision of a child who may run into the scarifier.
5. Keep children away from hot or running engines. They can suffer burns from a hot muffler.
6. Never allow children under 16 years of age to operate this machine. Children 16 and over should read and understand the instructions and safe operation practices in this manual and on the machine and be trained and supervised by an adult.

SERVICE

Safe Handling of Petrol:

1. To avoid personal injury or property damage use extreme care in handling petrol. Petrol is extremely flammable, and the vapors are explosive. Serious personal injury can occur when petrol is spilled on yourself or your clothes, which can ignite. Wash your skin and change clothes immediately.
2. Use only an approved petrol container.
3. Never fill containers inside a vehicle or on a truck or trailer bed with a plastic liner. Always place containers on the ground away from your vehicle before filling.
4. Remove petrol-powered equipment from the truck or trailer and refuel it on the ground. If this is not possible, then refuel such equipment on a trailer with a portable container, rather than from a petrol dispenser nozzle.
5. Keep the nozzle in contact with the rim of the fuel tank or container opening at all times until fueling is complete. Do not use a nozzle lock-open device.
6. Extinguish all cigarettes, cigars, pipes and other sources of ignition.
7. Never fuel machines indoors because flammable vapors will accumulate in the area.
8. Never remove petrol cap or add fuel while engine is hot or running. Allow engine to cool at least two minutes before refueling.
9. Never over fill fuel tank. Fill tank up to 80% capacity to allow for expansion.
10. Replace petrol cap and tighten securely.
11. If petrol is spilled, wipe it off the engine and equipment. Move machine to another area. Wait 5 minutes before starting engine.
12. Never store the machine or fuel container near an open flame, spark or pilot light on petrol appliances.
13. To reduce fire hazard, keep machine free of grass, leaves, or other debris build-up. Clean up oil or fuel spillage and remove any fuel-soaked debris.
14. Allow machine to cool at least 5 minutes after use, before storing.

General Service:

1. Never run an engine indoors or in a poorly ventilated area. Engine exhaust contains carbon monoxide, an odorless and deadly gas.
2. Before cleaning, repairing, or inspecting, make certain the tines and all moving parts have stopped. Disconnect the spark plug wire and ground against the engine to prevent unintended starting.
3. Check the tines and engine mounting bolts at frequent intervals for proper tightness. Also, visually inspect tines for damage. Replace with the original equipment manufacturer's (O.E.M.) parts only, listed in this manual. "Use of parts which do not meet the original equipment specifications may lead to improper performance and compromise safety!"
4. Keep all nuts, bolts, and screws tight to be sure the equipment is in safe working condition.
5. Never tamper with safety devices. Check the correct operation regularly.
6. After striking a foreign object, stop the engine, disconnect the spark plug wire and ground against the engine. Thoroughly inspect the scarifier for any damage. Repair the damage before starting and operating the scarifier.
7. Scarifier components, guards and shields are subject to wear and damage which could expose moving parts or allow objects to be thrown. For safety protection, frequently check components and replace immediately with original equipment manufacturers (O.E.M.) parts only, listed in this manual. "Use of parts which do not meet the original equipment specifications may lead to improper performance and compromise safety!"
8. Do not change the engine's governor setting or over-speed the engine. The governor controls the maximum safe operating speed of the engine.
9. Check fuel line, tank, cap, and fittings frequently for cracks or leaks. Replace if necessary.
10. Do not crank engine with spark plug removed.
11. Maintain or replace safety and instruction labels, as necessary.
12. Observe proper disposal laws and regulations. Improper disposal of fluids and materials can harm the environment.

DO NOT MODIFY THE ENGINE

To avoid serious injury or death, do not modify the engine in any way. Tampering with the governor setting can lead to a runaway engine and cause it to operate at unsafe speeds. Never tamper with factory setting of engine governor. Please refer to the Briggs & Stratton engine manual, before undertaken any inspection, repair or maintenance.



INSTRUCTION MANUAL

PERSONAL SAFETY

1. This machine is not intended for use by persons (including children) with reduced physical, sensory or mental capabilities, or lack of experience and knowledge, unless they have been given supervision or instruction concerning use of the machine by a person responsible for their safety.
2. Children should be supervised to ensure that they do not use or play with the machine.
3. Stay alert, watch what you are doing and use common sense when operating this machine.
4. Do not use this machine while you are tired, ill or under the influence of drugs, alcohol, or medication. A moment of inattention while operating this machine can cause you to lose control & may result in series personal injury.
5. Use safety equipment. Always wear eye protection. Safety equipment such as a dust mask, non-skid safety shoes, hard hat, or hearing protection used for appropriate condition will reduce personal injuries.
6. Dress properly. Do not wear loose clothing or jewellery. Keep your hair, clothing & gloves away from moving parts. Loose clothes, jewellery or long hair can be caught in moving parts.
7. Prolonged use of the machine may lead to disorders of blood circulation in hands caused by vibration. These effects can be worsened by low ambient temperatures and/or by gripping the handgrips excessively tightly. Period of use you can extend with appropriate gloves or regular breaks. Take frequent work breaks. Limit the amount of exposure per day.

SPECIFICATIONS

Model No.	WEPLS400P
Product No.	1938264001
Working Width	400 mm
Working Depth	8 settings (5 to -15 mm)
Scarifier Blades (Total)	18 pcs
Scarifier Blade Diameter	166 mm
Aerator Tines (Total)	28 pcs
Aerator Tines Diameter	141 mm
Engine	10R2
Fuel Type	Unleaded Petrol
Engine Displacement	163 cc
Engine Power (Max)	3.3 kW
Working Speed	2700/min
Full Tank Capacity	3 L
Oil Tank Capacity	0.6 L
Recommended Spark Plug	Refer to B&S engine manual
Spark Plug Gap	0.76 mm
Spark Plug Torque	20.3 Nm.
Sound Power Level L_{WA} :	98 dB(A)
Vibration Level:	Left Handle 19.7 m/s^2 Right Handle 24.98 m/s^2
Weight:	34 kg

The manufacturer reserves the right to change the product specification and livery according to continued product improvements.





INSTRUCTION MANUAL

KNOW YOUR MACHINE

1. OPC/Brake Lever	2. Upper Handle
3. Lower Handle	4. Height Adjuster
5. Rear Flap	6. Collector

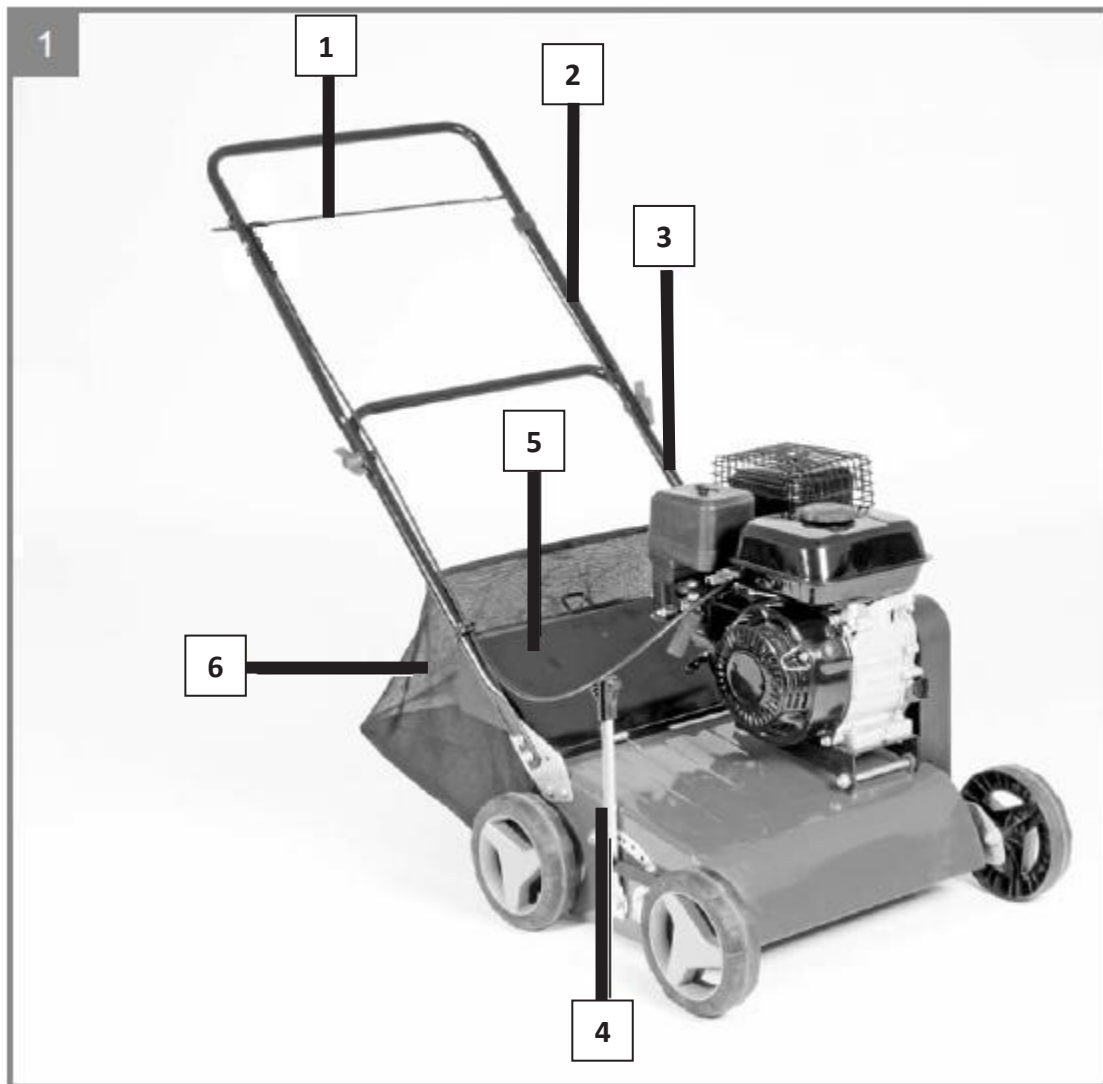

* Image may vary from actual machine

The lawn scarifier is pushed by hand over the area of grass to be cut. The cutters are driven by a petrol engine. The depth of cut is set by varying the central height-adjustment mechanism individually.

AERATOR: The cylinder rotates and removes the felt layer formed by moss, lichen and weeds and conveys the scarified material to the outside or into the grass catcher. During cutting the cutters penetrate the ground and therefore ensure that the lawn is loosened and absorbs nutrients better. We recommend dethatching the lawn in spring (April/May) and autumn (October).

SCARIFIER: The cylinder rotates and combs the lawn or aerates the slightly mossy areas. The removed moss is conveyed outwards or into the grass catcher. During aeration, the surface of the ground is scratched; this improves water drainage and facilitates the absorption of oxygen. We recommend scarifying the lawn during the entire growing period as and when required.

ASSEMBLY

Remove the machine and contents from the carton. Be sure the carton is empty before discarding.
If you require assistance with regards to the contents or operation of the machine, please contact us:

Tel: 01793 333212

Email: customerservice@webbgardenpower.co.uk

**Opening hours weekdays: February to October 8:30am - 5:30pm / November to January 8:30am - 5:00pm
(Closed Bank Holidays)**

IMPORTANT INFORMATION

NOTE: This product is a 4-stroke engine powered machine.

THE ENGINE IS SHIPPED WITHOUT PETROL OR OIL.

You **MUST** fill with the engine with recommended 4-stroke SAE30 or 10W/30 air cooled lawnmower engine oil **BEFORE** starting. Please follow the steps in the Briggs & Stratton engine manual on filling the engine.

Fresh (Under 30 days old from the date of purchase) unleaded petrol must be used in this unit. **DO NOT** use Ethanol based fuels. **DO NOT** mix oil with fuel.



WARNING

Stop the engine and unplug the spark plug before any repairs or maintenance operations.

DO NOT attempt to start this machine without it first being **FULLY** assembled.

DO NOT attempt to start this mower without first adding 4-stroke SAE30 or 10W/30 air cooled lawnmower engine oil to the engine.

WHAT YOU WILL RECEIVE

1. OPC/Brake Lever	2. Upper Handle
3. Lower Handle	4. Height Adjuster
5. Rear Flap	6. Collector
7. 2x Upper Handle Wing Nut	8. 4x Lower Handle Bolt
9. 4x Lower Handle Nut	10. Cable Clip
11. 2x Upper Handle Bolt	12. Scarifier Blade Cartridge
13. Aerator Sprung Cartridge	14. Main Body

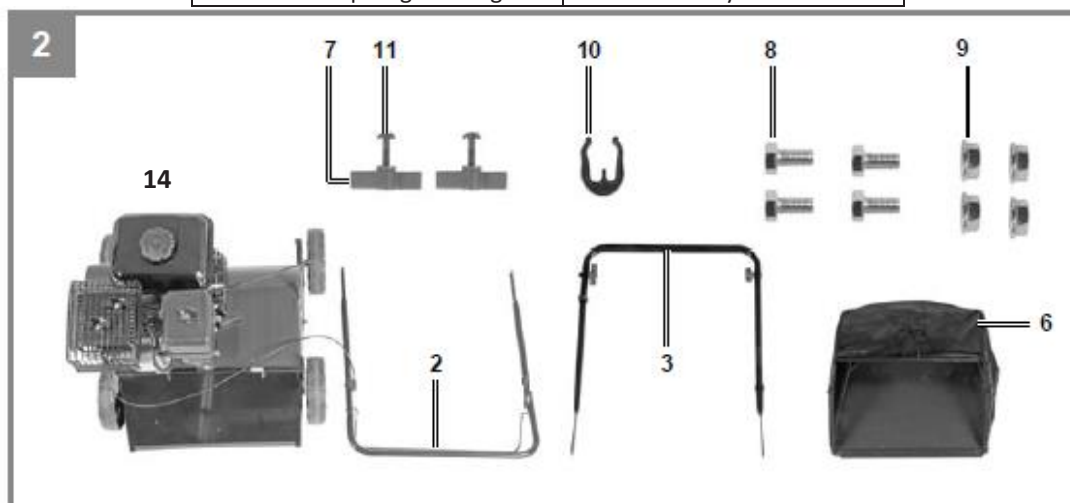



INSTRUCTION MANUAL

LOWER HANDLE

1. Attach the lower handle to the handle brackets affixed to the deck of the scarifier.
2. The lower handle sits on the outside of the handle brackets. Line up the fixing holes of the lower handle with those on the handle brackets.
3. Place the 4x lower handle bolts through the lower handle and the handle bracket and secure with the 4x lower handle nuts and tighten with the relevant sized spanner (Not supplied).

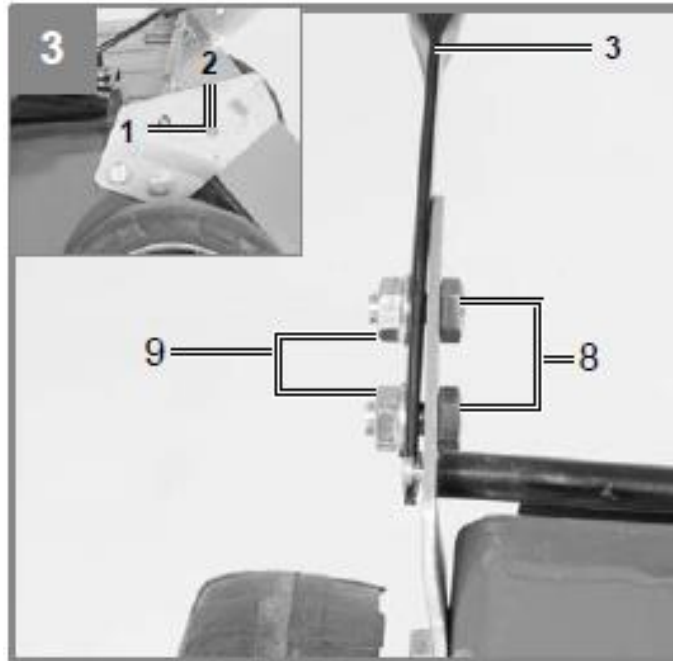

UPPER HANDLE

1. Place the upper handle onto the outside of the lower handle and line up the fixing hole of both handles.
2. Secure with the 2x upper handle bolts and 2x wing nuts. The wing nuts should sit on the outside of the handle assembly. Tighten until finger tight.

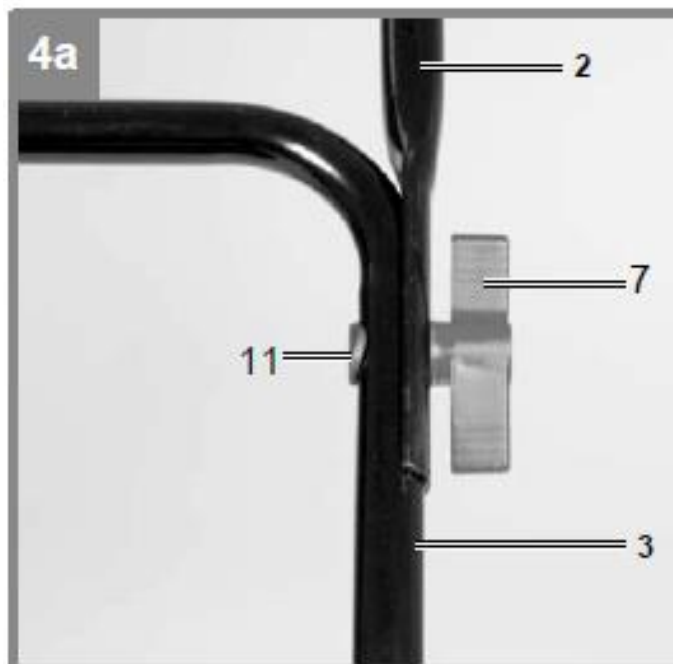

CABLE CLIP

1. Secure the operating cable of the machine to the handle assembly, by placing the cable into the cable clip and then place the cable clip onto the handle assembly

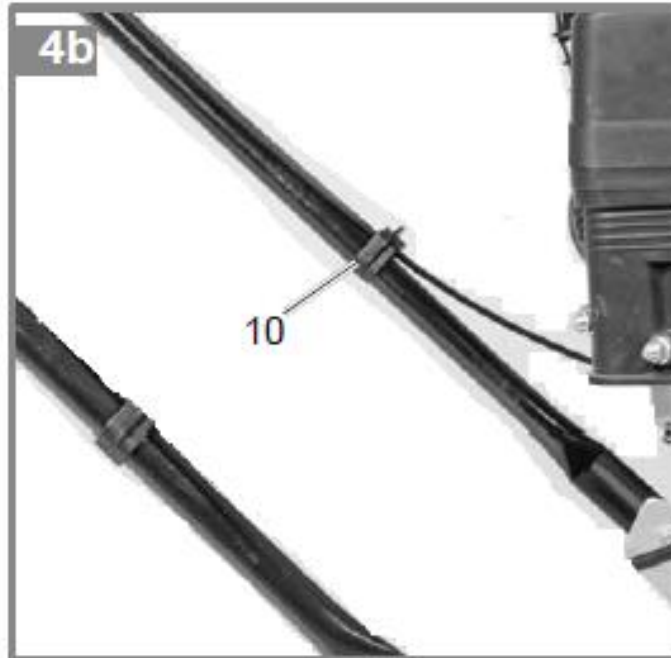

COLLECTOR

Important: Before you attach the collector, please ensure that the engine is switched off and the blade/tines are not rotating.

1. Lift the rear flap and hook the collector on to the bar of the rear flap.
2. Place the rear flap onto the collector to secure.





INSTRUCTION MANUAL

PRE-OPERATION

FUEL & OIL



WARNING

YOUR MACHINE IS SUPPLIED WITHOUT ENGINE OIL OR UNLEADED PETROL

Operating the engine with insufficient oil can have catastrophic consequences. Any failure caused by insufficient oil, will not be covered by the manufacturer's warranty.

Read instructions carefully.



Fuel & its vapors are very flammable. Do not use or fuel the machine near a flame, sparks or while smoking. Allow the engine to cool for more than 3 minutes, before re-fueling. Never fuel the machine with the engine running. Fuel the engine at least 15 metres away from your work area. Always fuel your machine outdoors.

IMPORTANT:

Fuel which is older than 30 days old can become stale and cause acid & gum deposits in the fuel system or essential carburettor components. This could result in starting issues which would not be covered by the manufacturer's warranty.

Ensure that any stored petrol is clearly marked in a separate appropriate canister for a maximum of 30 days if not mixed with a fuel additive. If the machine is not going to be used for a long period, drain the petrol from the fuel tank, start the engine and drain the carburetor of any remaining fuel.

To keep fuel fresh, refer to instructions from the engine manual supplied with this machine. A fuel additive which you add to your fuel, can help make your machine easier to start, extend the shelf life of your fuel for up to two years, keeping the carburettor & engine clean, plus reducing emissions and increasing fuel economy.

ADD FUEL & OIL

IMPORTANT:

Oil and fuel specifications and levels are referred to in the Briggs & Stratton engine manual supplied with this machine. Do not attempt to use the machine if you are missing the Briggs & Stratton engine manual, please contact us.

OPERATION

IMPORTANT:

The engine does not come with oil in it. Therefore, be sure to add oil before starting the engine. The oil level in the engine must be checked each time before operating.

IMPORTANT:

When the engine OPC/brake lever is released it must return to its initial position and the engine must stop. If this does not happen, do not use the equipment again.

ENGINE STARTING & STOPPING

In order to avoid any unintentional start-ups of the engine, it comes equipped with an OPC/brake lever, which must be pressed at all times whilst the device is in use. When released, the engine will stop.

STARTING THE ENGINE - COLD

1. Place height adjuster into it's highest position.
2. Check the engine oil. See **Check Oil Level** section within engine manual
3. Move the stop switch at the front of the engine to the ON position.
4. Move the Choke lever to the CLOSED position.
5. Pull the OPC/brake lever towards the top handle.
6. Grab the recoil starter handle and pull lightly until resistance is felt, then pull rapidly.
7. Allow the engine to warm up briefly and then set the choke lever to the OPEN position.
8. The blades/tines are now rotating. Lower to the required height, using the height adjuster.



STARTING THE ENGINE - WARM

1. Place height adjuster into it's highest position.
2. Move the stop switch at the front of the engine to the ON position.
3. Move the Choke lever to the OPEN position.
4. Pull the OPC/brake lever towards the top handle.
5. Grab the recoil starter handle and pull lightly until resistance is felt, then pull rapidly.
6. The blades/tines are now rotating. Lower to the required height, using the height adjuster.

CAUTION

Do not allow the starter grip to snap back against the engine. Return it gently to prevent damage to the starter.



WARNING

The scarifier blade/tines begin to rotate as soon as the engine is started.

Never open the collector flap when the engine is running. A rotating cutting unit can cause injuries.

Always fasten the collector flap carefully. The flap flips back to the "Closed" position with tensioned springs!

STOPPING THE ENGINE

1. Release the OPC/brake lever to stop the engine.

IMPORTANT:

The blade/tines continue to rotate for a few seconds after the motor is switched off. Never attempt to stop the cassette yourself. In the event that the blade/tines strike an object, immediately switch off the machine and wait for the blade/tines to come to a complete stop. Inspect the condition of the blades/tines. Replace any parts that are damaged.



INSTRUCTION MANUAL

USING YOUR SCARIFIER/AERATOR

Be sure the working area is clear of stones, sticks, wire, or other objects which could damage the scarifier or engine. Such objects could be accidentally thrown by the scarifier in any direction and cause serious personal injury to the operator and others.

Always ensure that a safe distance (provided by the long handles) is maintained between the user and the housing. Be especially careful when scarifying and changing direction on slopes and inclines. Maintain a solid footing and wear sturdy, non-slip footwear and long trousers.

Do not work on excessively steep slopes, a maximum slope of 15 degrees is recommended. If a slope is difficult to stand on, do not trim. Do not trim on slopes when the ground is slippery or wet. Trim across the face of a slope, not up and down.

Use special caution when backing up and pulling the scarifier (tripping hazard)!



WARNING

The operation of any scarifier can result in foreign objects being thrown into eyes, which can cause severe damage. Always wear safety glasses or goggles while operating the scarifier/aerator, or while performing any adjustments or repairs on it.

Shut the engine off and wait until the scarifier/aerator head comes to a complete stop before cleaning the discharge area. The scarifier/aerator head continues to rotate for a few seconds after OPC/Brake lever is released.



CAUTION

While operating the scarifier, do not allow the blades/tines to contact concrete, tarmac or gravel surfaces. Doing so will result in premature wear.

CHANGING THE WORKING DEPTH

IMPORTANT:

Turn the engine off, prior to making any height adjustment.

To set the working depth, push the height adjuster lever (4) gently away from the deck and move up or down the height gauge, set to the required depth and then lock the lever back into position.

Moving the lever to the right raises the blade and to the left lowers the blade from 5 to -15mm.

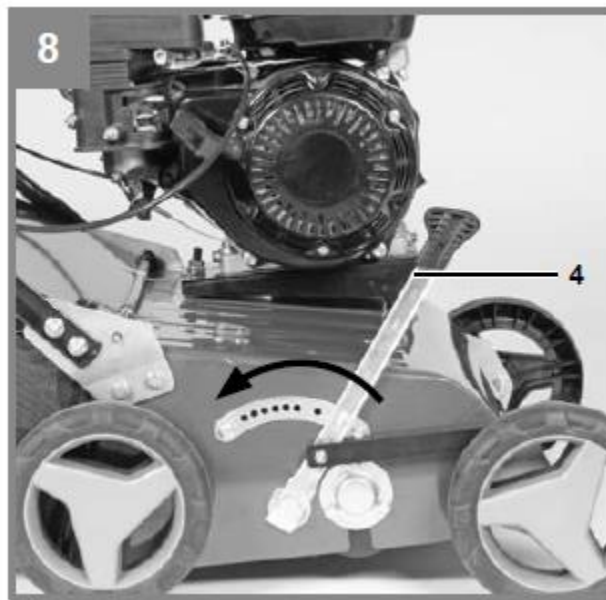

TRANSPORT

When moving the machine to and from the work area, always ensure the height adjustment lever is placed in the highest cutting height to ensure the blades/tines are not in contact with the ground.

CHANGING THE CYLINDER - MINIMUM TWO ADULT ACTION



WARNING

When changing the cylinder, ensure suitable hard-wearing gloves are worn at all times



CAUTION

Only use genuine blade/tine cylinders with this machine.

The equipment can be assembled with the Dethatching (blades) or Scarifying (Spring Tines) cylinders. Only replace the cylinder with an original Webb product, to ensure top performance & safety. To change the cylinder, proceed as follows. We recommend this is undertaken by a minimum of two adults and that suitable hard-wearing gloves are worn at all times.

1. Remove the belt cover from the machine. (Fig. 1)
2. Remove the blade belt from the top and bottom pulley's. (Fig. 2)
3. Remove the bottom pulley (Fig. 3, 4 & 5)
4. Loosen the bearing mounting block away from the left side of the machine deck, which was positioned underneath the bottom pulley, by removing the three fixing screws. (Fig. 6).
5. Loosen the bearing cover away from the height adjuster lever side of the machine (right), by removing the three fixing screws (Fig. 7).
6. With the machine tipped backwards and held by a second person, slide the cylinder from the machine.
7. Remove the bearing cover, mounting block and mounting cover from the end's of the removed cylinder (Fig. 9)
8. Slide the mounting covers onto each side of the cylinder to be fitted. Now fit the bearing cover and mounting block to either end of the cylinder. (Fig. 8)
9. With the machine tipped backwards and held by a second person, slide the cylinder on to the machine with the mounting covers on the inside of the deck and bearing cover & mounting block on the outside.
10. Ensure the fixing holes of the mounting cover and bearing cover on the right side of the machine are aligned with the fixing holes of the deck. Assemble with the three fixing screws (Fig. 7)
11. Repeat step 10 with the mounting block and cover on the left side of the machine and assemble with the three fixing screws (Fig. 6).
12. Refit the bottom belt pulley to the left side of the machine deck (Fig. 5, 4 & 3)
13. Adjust bolt in Fig. 10, located under engine mounting plate to match image.
14. Refit blade belt over top and bottom pulley's (Fig. 2)
15. Refit belt cover (Fig. 1).



Fig.1



Fig. 2



INSTRUCTION MANUAL

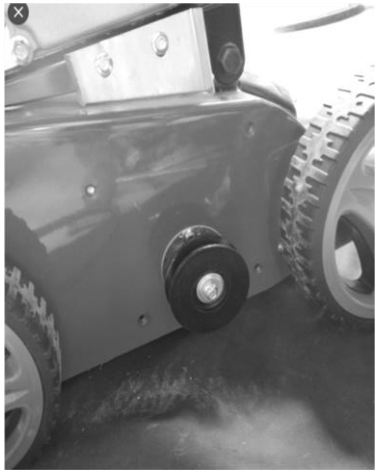

Fig. 3



Fig. 4

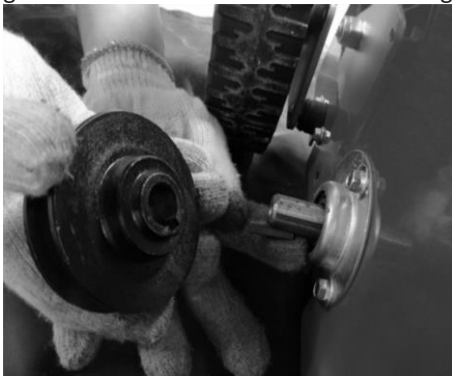

Fig. 5



Fig. 6

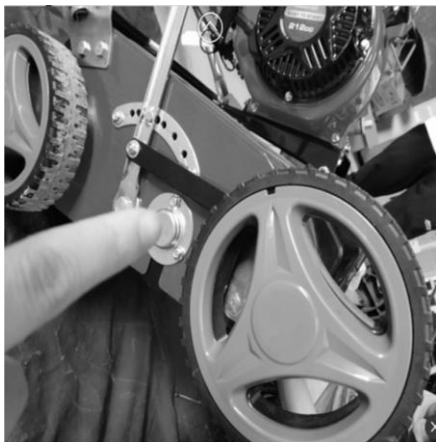

Fig. 7

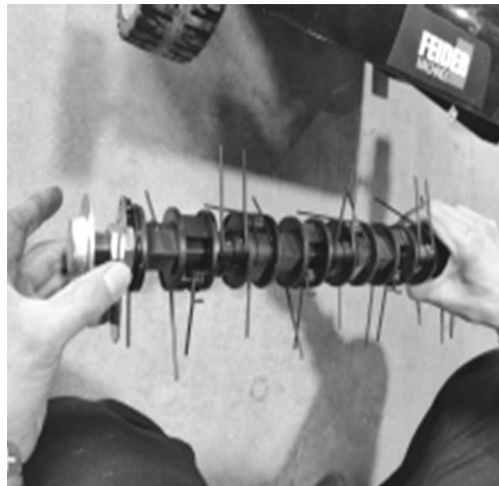

Fig. 8



Fig. 9

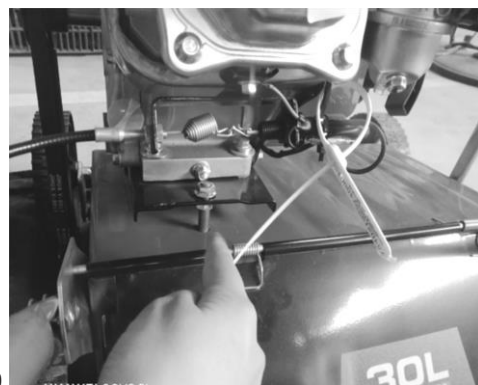

Fig. 10

MAINTENANCE, CLEANING & STORAGE



WARNING

Improper maintenance & storage of the machine may void your warranty. Keep the machine clean for better and safer performance.

Turn off the engine before performing any maintenance. If the engine must be run, make sure the area is well ventilated. The exhaust emits dangerous carbon monoxide gases.

MAINTENANCE

General Recommendations

1. Always observe safety rules when performing any maintenance.
2. The warranty on this scarifier/aerator does not cover items that have been subjected to operator abuse or negligence. To receive full value from the warranty, the operator must maintain the scarifier/aerator as instructed.
3. Changing of the engine-governed speed will void engine warranty.
4. All adjustments should be checked at least once each season.



WARNING

Always stop engine, disconnect spark plug, and ground the spark plug cap against the engine before performing any type of maintenance on your machine.

Lubrication

1. Lubricate pivot points on the OPC/brake lever at least once a season with general maintenance spray. This control must operate freely in both directions.
2. Lubricate the wheels at least once a season with general maintenance spray. If wheels are removed for any reason, lubricate surface of the axle bolt and inner surface of the wheel with general maintenance spray.

Check/Add Oil - (Always refer to the Briggs & Stratton Engine Manual)

1. Remove the dipstick and wipe with a clean cloth.
2. Insert the dipstick into the filler neck without screwing it in.
3. Remove the dipstick and check the oil level. The oil level should be in between the MIN. and MAX. levels on the dipstick.
4. If low, add oil slowly into the engine oil fill tube (the use of a funnel will aid the filling). Do not overfill. After adding oil wait one minute and then recheck the oil level.
5. Replace and tighten the dipstick.

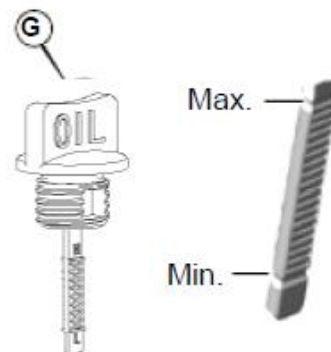
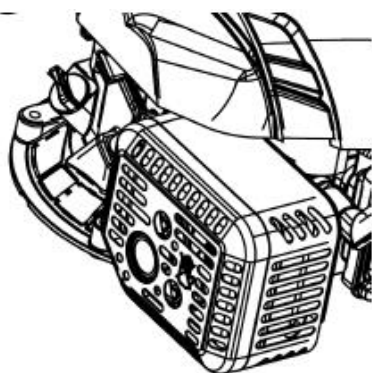



INSTRUCTION MANUAL

Spark Plug - (Always refer to the Briggs & Stratton Engine Manual)

To ensure proper engine operation, the spark plug must be properly gapped and free of deposits.

1. Remove the spark plug cap.



WARNING

If the engine has been running, the exhaust (muffler) will be very hot. Be careful not to touch the exhaust (muffler).

2. Visually inspect the spark plug. Discard it if the insulator is cracked or chipped.
3. Measure the spark plug gap with a feeler gauge. The gap should be 0.76, correct as necessary by bending the side electrode.
4. Attach the plug washer, thread the plug in by hand to prevent cross-threading.
5. When mounting a new spark plug, you should screw 1/2 more thread with the wrench after the washer is compressed. If you are mounting an old one, you should only screw 1/8-1/4 more thread.



CAUTION

The spark plug must be securely tightened. An improperly tightened plug can become very hot and possibly damage the engine. Never use a spark plug with an improper heat range.

CLEANING

Engine Care - (Always refer to the Briggs & Stratton Engine Manual)

Clean the engine regularly with a cloth or brush. Keep the top of the engine clean to permit proper air circulation. Remove all grass, dirt and debris from the exhaust (muffler) area.



CAUTION

Do not use a water hose or pressure washer to clean the engine. Water can damage the engine or contaminate the fuel system.

1. Engines stored for over 30 days need to have the fuel drain from the fuel tank or a fuel stabilizer applied to prevent deterioration and gum forming in the fuel system or essential carburetor parts.

Deck Care

Clean underside of the machine after each use to prevent build-up of grass clippings or other debris. Follow steps below:

1. Disconnect the spark plug cap. Drain petrol from the scarifier with a suction pump. Alternatively, tip the scarifier so that it rests on its side. Keep the side with the air filter housing facing up. Drain all fuel from fuel tank into proper receptacle for storage. Secure the scarifier.



WARNING

Never tip the scarifier more than 90 degrees in any direction and do not leave the scarifier tipped for any excessive length of time. Oil can drain into the upper part of the engine causing a starting problem.

2. Scrape and clean the underside of the machine with a suitable tool. Do not spray with water.
3. Put the scarifier back onto its wheels on the ground.
4. Clean the engine regularly with a cloth or brush. Keep the cooling system (blower housing area) clean to permit proper air circulation which is essential to engine performance and life. Be certain to remove all dust, dirt and combustible debris from exhaust area.

STORAGE & TRANSPORT

The following steps should be taken to prepare your scarifier for storage.

2. Empty the fuel tank. Disconnect the spark plug cap. Drain petrol from the scarifier with a suction pump. Alternatively, tip the scarifier so that it rests on its side. Keep the side with the air filter housing facing up. Drain all fuel from fuel tank into proper receptacle for storage. Secure the scarifier.



WARNING

**Do not drain the petrol in enclosed spaces, in proximity of open fire, etc.
Do not smoke! Petrol fumes can cause explosion or fire.**

3. While engine is still warm, change oil. See Engine Oil Change section of this manual.
 4. Clean engine of surface debris, chaff or grass.
 5. Remove spark plug. Place 1 teaspoon or 5 ml. of oil into spark plug hole.
 6. Pull starter rope slowly 8-10 times to properly coat the cylinder bore and piston for storage.
 7. Replace spark plug and tighten. Any residual oil may burn off in subsequent starts. This may result in white smoke emission from muffler.
 8. This scarifier/aerator may be stored in a variety of positions. It is best to store in horizontal position with the spark plug up. Do not store or transport with the spark plug down.
- NOTE:** Storing or transporting with the spark plug down will result in hard starting and/or engine smoking.
- Store in a dry, clean and frost-protected place, out of reach of unauthorised persons.
 - When removing unit from storage, only use fresh petrol. Perform operation checks (see maintenance schedule) before starting engine.
9. Keep out of direct sunlight.



CAUTION

The engine must have completely cooled down before storing.

- NOTE:** When storing any type of power equipment in an unventilated or material storage shed,
- Care should be taken to rust-proof the equipment. Using a light oil or silicone, coat the equipment, especially cables and all moving parts.
 - Be careful not to bend or kink cables.
 - If the starter rope becomes disconnected from rope guide on handle, disconnect and ground the spark plug cap. Pull the OPC/brake lever up to and against the upper handle and pull the engine recoil starter handle slowly out of the engine.

DO NOT STORE fuel for longer than 30 days. Fuel can become stale and cause damage to the engine carburetor, which is not covered by the machines manufacturer's warranty.



INSTRUCTION MANUAL

TROUBLE SHOOTING

PROBLEM	POSSIBLE CAUSES	REMEDIAL ACTION
Engine does not start	Engine does not start	Move throttle choke to correct position
	Fuel tank is empty.	Fill tank with fuel: refer to ENGINE OWNERS MANUAL.
	Spark plug loose.	Tighten spark plug.
	Spark plug wire loose or disconnected from plug.	Install spark plug wire on spark plug.
	Spark plug gap is incorrect	Set correct gap between electrodes.
	Spark plug is defective.	Install new, correctly gapped plug: refer to ENGINE OWNERS MANUAL.
	Carburetor is flooded with fuel.	Remove air filter and pull starter rope continuously until carburetor clears itself and install air filter element.
Engine speed drops off	Depth of cut too great	Air filter clogged
	Grass too high	Mow the lawn before scarifying
	Exit chute blocked	Turn off engine, let blade/tines stop rotating. Remove spark plug cap. Remove collector and empty. Lift rear flap and clear any debris in exit chute. Refit collector.
	Air filter clogged	Clean air filter: refer to ENGINE OWNERS MANUAL.
Poor scarification results	Depth of cut too small	Set to deeper depth of cut
	Worn cutting blades	Have cutting blades sharpened or replaced by garden machinery specialist.
Collector never fills	Collector is clogged	Stop scarifier. Unload grass catcher or clean it
	Ejector channel blocked	Turn off engine, let blade/tines stop rotating. Remove spark plug cap. Remove collector and empty. Lift rear flap and clear any debris in exit chute. Refit collector.
Unusual noises	Bolts, nuts or other mounting parts slack.	Tighten parts
Vibration	Cutting assembly is loose	Tighten blade
	Cutting assembly is unbalanced	Have cutting blades sharpened or replaced by garden machinery specialist.



EC DECLARATION OF CONFORMITY

We Handy Distribution Ltd - SN3 5HY (Importer) declare that the product:

Designation: Petrol Scarifier/Aerator
Model(s): WEPLS400P
Product No.: 1938264001
Type/Serial No. As per rating label on machine
Engine Displacement: 163 cm³
Rated Engine Power: 3.3 kW / 2700 rpm
Working Width: 400 mm

Complies with the following directives:

Machinery Directive 2006/42/EC

The conformity assessment procedure followed was in accordance with EN ISO 14982:2009.

Noise Directive 2000/14/EC

Sound Power Level L_{WA} : 98 dB(A) - uncertainty: 3.0 dB(A) According to 2000/14/EC
Vibration a_{hv} : Left Handle 19.7 m/s², Right Handle 24.98 m/s² - uncertainty K: 1.5 m/s²

Notified Body:

TÜV Rheinland (Guangdong) Ltd,

Addresses:

No.199 Kezhu Road, Guangzhou Science City, Guangzhou 510663, Guangdong Province P.R. China

Authorised signatory and technical file holder

Date: 22/06/2020

Signature:

A handwritten signature in black ink, appearing to read "S Belcher", written over a horizontal line.

Name: Mr Simon Belcher

Position: Chairman

Company: Handy Distribution Ltd

Address: Murdock Rd, Swindon, Wiltshire, SN3 5HY.





INSTRUCTION MANUAL

PARTS DIAGRAM - WEPLS400P 1938264001

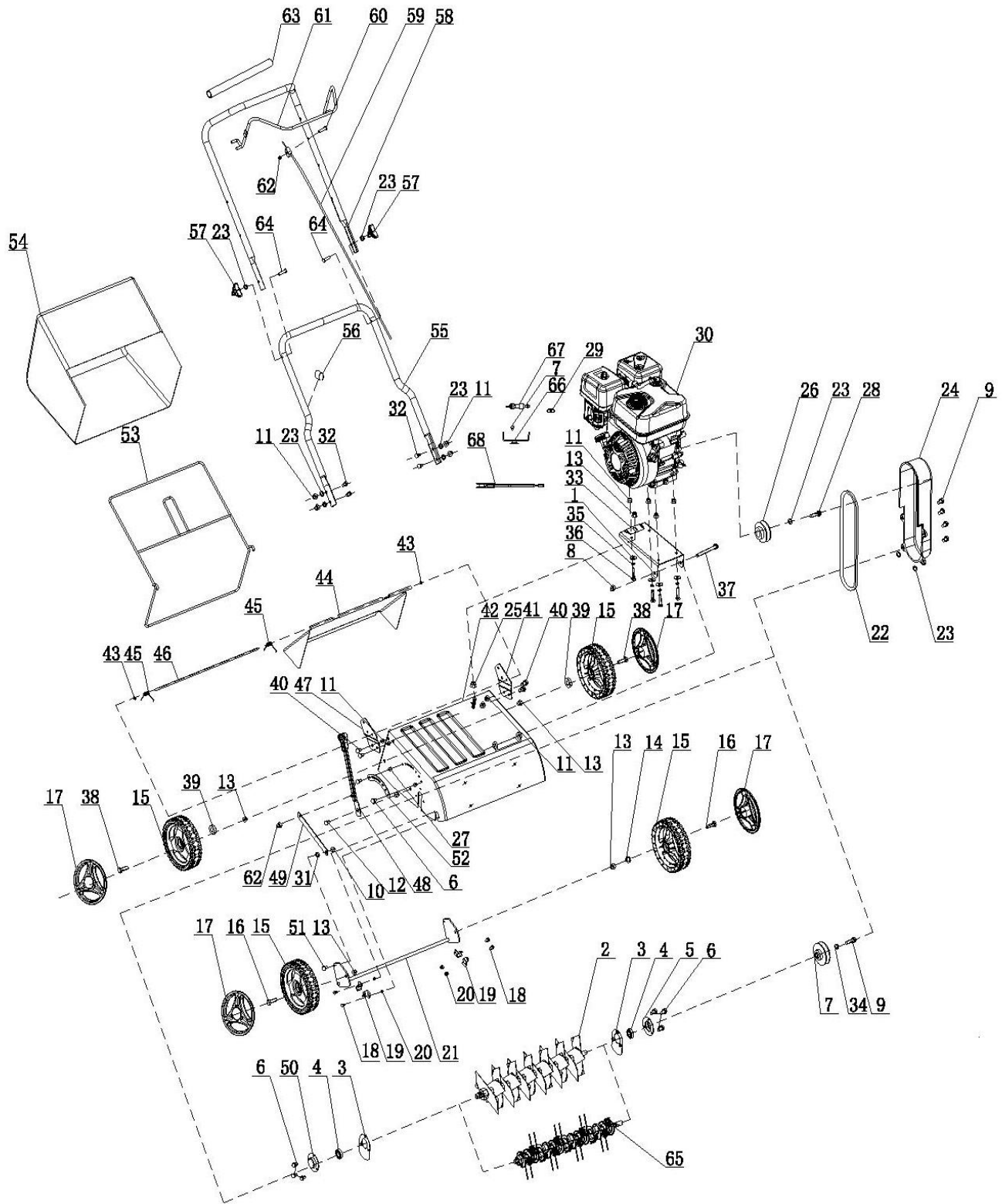

PARTS LIST - WEPLS400P 1938264001

Item No	Webb Part No.	Webb Description	Qty	Item No	Webb Part No.	Webb Description	Qty
1	WE182-94294	Flat Washer 30x10.5x2.5	4	35	WE149-94040	Spring Washer 8.1x2.1	4
2	WE182-632001	Scarifier Blade Cartridge	1	36	WE182-91993	Bolt M8x40	4
3	WE182-632007	Mounting Cover	2	37	WE182-92113	Bolt M10x130	1
4	WE182-93037	Bearing	2	38	WE182-636002	Rear Wheel Bolt	2
5	WE182-632006	Bearing Mounting Block	1	39	WE182-636003	Rear Axle Sleeve	2
6	WE156-91325	M6X12 Bolt	7	40	WE153-91881	Bolt M8x16	4
7	WE182-636015	Blade Pulley	1	41	WE182-631003	Left Handle Bracket	1
8	WE182-90050	M10 Nut	1	42	WE182-631008-333	Deck	1
9	WE150-91329	M6x16 Bolt	5	43	WE153-94036	Circlip 5	2
10	WE153-90061	Nut M6	1	44	WE182-634001	Rear Grass Flap	1
11	WE149-90059	Nut M8	11	45	WE182-634002	Rear Grass Flap Spring	2
12	WE182-91927	Step bolt	1	46	WE182-634003	Rear Grass Flap Shaft	1
13	WE149-90057	Nut M10x1.5	5	47	WE182-634004	Right Handle Bracket	1
14	WE149-94270	Washer 10.5x30x2.5	1	48	WE182-633001	Height Adjustment Lever	1
15	WE165-606140	Wheel	4	49	WE182-633003	Height Adjustment Rod	1
16	WE182-606060	Bolt M10	2	50	WE182-632005	Bearing Cover	1
17	WE182-606144-198	Wheel Trim	4	51	WE182-91926	Step bolt	1
18	WE182-91322	Bolt M5x12	4	52	WE182-633002	Height of Cut Board	1
19	WE182-636004	Front Axle Bush	4	53	WE182-634005	Collector Frame	1
20	WE182-90015	Nut M5	4	54	WE182-634004-057	Collector Bag	1
21	WE182-636001	Front Axle	1	55	WE182-635001-206	Lower Handle	1
22	WE182-606007	Belt	1	56	WE182-605159	Cable Clip	1
23	WE149-94041	Washer 8.4x24x2	9	57	WE160-605098-198	Triangle Knob (Grey)	2
24	WE182-636016-010	Belt Cover	1	58	WE182-605008-206	Upper Handle	1
25	WE182-90075	Nut M10x1.5	1	59	WE182-635003	OPC/Brake Cable	1
26	WE182-636014	Belt Pulley	1	60	WE153-91870	Bolt M6x35	1
27	WE153-90058	Nut M6	2	61	WE182-605010-206	OPC Brake Lever	1
28	WE182-91228	Belt Pulley Bolt	1	62	WE153-90016	Nut M6	2
29	WE182-635006	Spring	1	63	N/A	Soft Grip Handle (Comes with 58)	1
30	N/A	B&S CR750 Engine	1	64	WE153-91868	Bolt Mx45	2
31	WE182-94261	Gasket 8.4x16x1	1	65	WE182-632008	Aerator Sprung Cartridge	1
32	WE182-92107	Bolt M8x30	4	66	WE182-635002	Bracket	1
33	WE182-631002	Engine Mounting Plate	1	67	WE182-635004	Spark Plug	1
34	WE149-94057	Washer 8	1	68	WE182-635007	Wire	1

Spare Parts are available from our Spares Team. Please call 01793 333212, option 1 for assistance.



INSTRUCTION MANUAL

This Service Book is provided with your Webb, to help you look after your purchase to our recommendations and enable you to take advantage of the conditional manufacturer domestic warranty*.

Present this service book to your authorised Webb repair dealer, whenever a service or a warranty appraisal is required.

The booklet is applicable to the following products, in the UK only:

- Ride On Lawn Tractors
- Cylinder Lawnmowers
- Petrol Rotary Lawnmowers
- Petrol Hand Held Range

Please register your machine using the following pages or at www.webbgardenpower.co.uk. By registering your machine, you agree to maintain the machine in accordance with the service schedules specified in this manual and services duly recorded. (Not applicable for Webb electric handheld machines). You may be asked to produce this booklet as proof of servicing in the event of a claim. Proof of purchase should also be kept as a reference.

Ensure you have the following information available from your machine product label. The two examples below can be found on your machine:



1. Model Number

2. Serial & Product Number

Please complete using BLOCK CAPITALS.
Sections marked* must be completed to validate Warranty.

SERVICE BOOK

1. Users Statement of Warranty

Each new machine is warranted against defective material or assembly of material under normal usage. The warranty applies to the original purchaser, is not transferable and covers faulty parts and the labour involved in replacing and repairing those parts, which are of original manufacture.

2. Period of Warranty - valid from 1 January 2020

Webb (excludes Dynamic, Legacy & Heritage), 2 year conditional warranty from the original date of sale to the first domestic user.

Webb (Dynamic, Legacy & Heritage) 1 year warranty from the original date of sale to the first domestic user.

90 days from the original date of sale to the professional/commercial or for hire user.

Engine warranty as per the engine manufacturer's warranty, which will be supplied with the machine.

90 days from the original date of sale for Replacement Spare Parts

All machines' must be serviced within the first 14 months from the original date of purchase, to qualify for a second year parts & labour warranty, details of the service must be recorded in the service record within this manual.

A reduced warranty period of 90 days applies to those items which are subject to normal wear and tear and in normal use, will need replacement or adjustment.

These items are chargeable after 90 days of ownership.

Filters
Tyres / Wheels
Drive chains and belts
Brake & clutch friction components
Control cable & starter cords
Fluids & lubricants
Spark plugs
Blades (Lawnmowers & Brushcutters)
Cutter bars (Hedgecutters)
Drive & clutch cable surfaces
Nylon Lines (Line Trimmers)
Carburettor cleaning
Bearings
Bushes
Electric cable
Grass collectors

3. Not covered by this warranty

(a) The warranty policy does not cover any depreciation or damages caused by ordinary wear, rusting or corrosion, lack of correct maintenance or operation, misuse, abuse, lack of transportation or accident.

(b) The warranty policy does not cover any costs necessary for the standard periodic maintenance services instructed by the operators manual, or service parts replacement which would include oil, filters, tyres, belts, brake linings, fuses, blades, seals and other service parts unless it can be proven that the item has evidence of faulty manufacture.

(c) The warranty policy will not cover failure or damage caused as a result of parts or accessories being modified without the written approval of GJ Handy & Co Ltd.

(d) The warranty policy will not cover the unit if non-genuine parts have been fitted and as a result damage has occurred to the unit.

(e) The warranty policy is non-transferable and is only applicable to the original purchaser.

4. Disclaimer

(a) This warranty is only a remedy for defect of products. GJ Handy & Co Ltd will never warranty in terms of the merchantability or the fitness for a particular purpose.

(b) No person is authorised to make any warranties, representations or promises, expressed or implied, on behalf of GJ Handy & Co Ltd, or to modify the terms conditions or limitation of this warranty policy in any way.



INSTRUCTION MANUAL

(c) Neither GJ Handy & Co Ltd nor any company affiliated with GJ Handy & Co Ltd shall be liable in any event or manner whatsoever for incidental or consequential damages or injuries, including, but not limited to, loss of crops, loss of profit, out of pocket expenses or profits, rental of substitute equipment or other commercial losses.

5. General

(a) Most warrantable failures show up within the first few weeks of use. These failures are usually straightforward and warranty assessment is relatively easy.

(b) Failures relating to cutter decks and belts need careful investigation, as the cause may not always be straightforward. Look for damage to blades and pulleys especially when the cutter belt or blade boss have snapped or cracked as this could be due to impact damage.

(c) Customers should always refer to the operator/instruction manual when any disputed problem arises, you will find most areas covered within the manual.

Protecting your machine

Maintenance

Regular maintenance of your Webb machine is essential to ensure it operates, safely, efficiently and therefore reducing the environmental impact.

It is the owner's responsibility to ensure that their Webb machine is maintained at specific intervals. Any approved Webb service dealer can undertake a service, which are specialised in our products and will be aware of your particular machine and any technical updates which will save valuable time & money.

If you are using your machine in dry, dusty or high temperatures, you will need to service the machine more regularly.

Fuel (if applicable)

Due to ongoing efforts by fuel companies to reduce emissions, unleaded petrol will oxidize & deteriorate in storage overtime, leaving residue from detergent components.

Fuel deterioration problems may occur when petrol is stored for over 30 days. If you are planning to store fuel for over 30 days, we recommend you add Handy Parts Sure-Start fuel stabilizer to fresh fuel after purchasing. Sure-Start cannot reconstitute stale fuel.

Storage

When storing your machine for an extended period, we do recommend that you follow the instructions of engine instruction manual.

Always store the fuel in a clean, approved and sealed container. If the container is steel, ensure it is not corroded. If the container is not filled to its recommended capacity, air can accelerate fuel deterioration.

Always store fuel away from direct sunlight, in a dark, cool environment.

SERVICE BOOK

Your servicing Webb approved dealer will stamp & date the below relevant sections, when the correct service actions have been completed.
PLEASE ENSURE THE SERVICE BOOK IS AVAILABLE FOR THE DEALER, DURING SERVICE WORK.

1st Service

This must be stamped by an approved service dealer to qualify for a free second year warranty.
(Excluding the Webb Electric Handheld machines)

12 Months

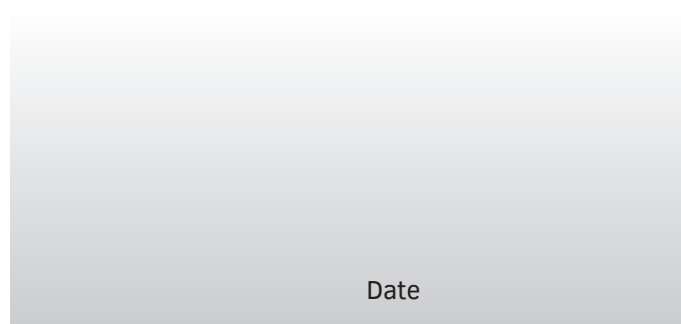

Date

24 Months

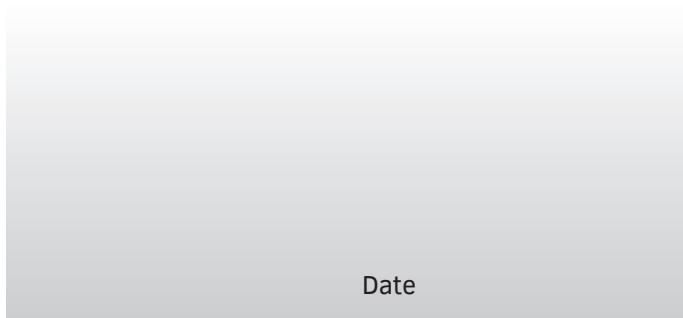

Date

36 Months

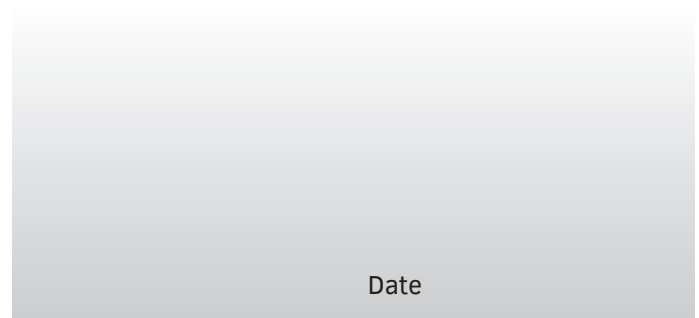

Date



INSTRUCTION MANUAL

48 Months

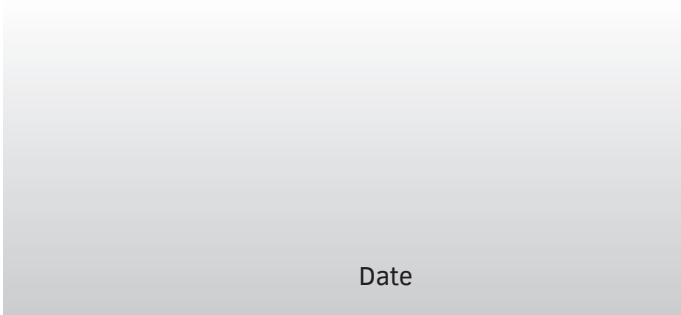

60 Months

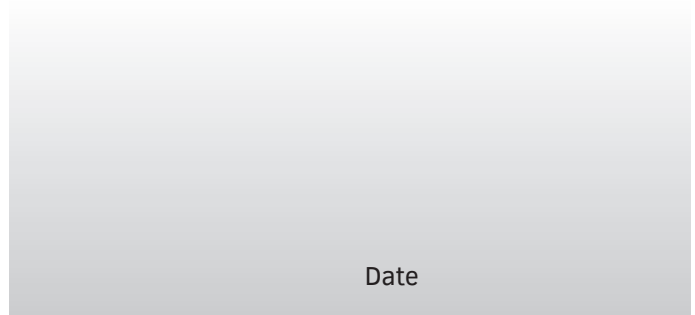

72 Months

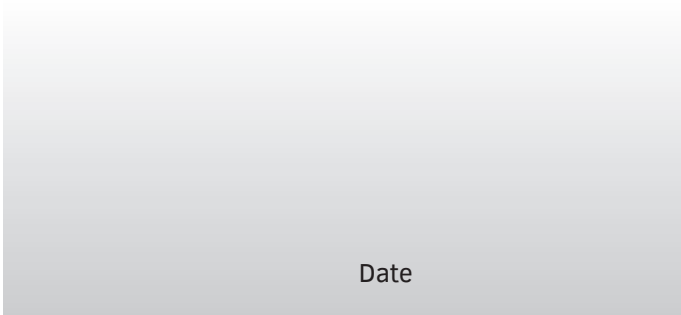

84 Months

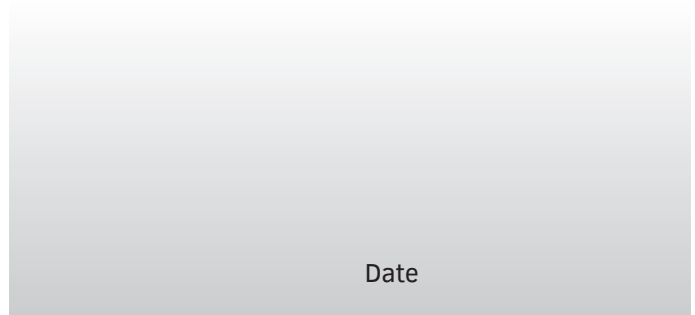

96 Months

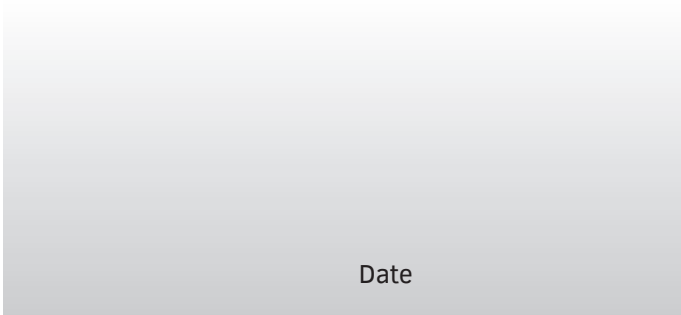

108 Months

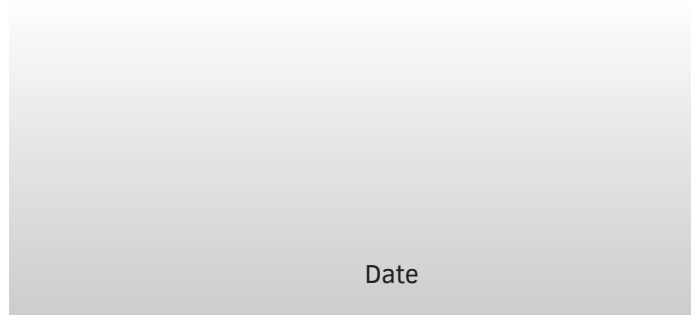

120 Months

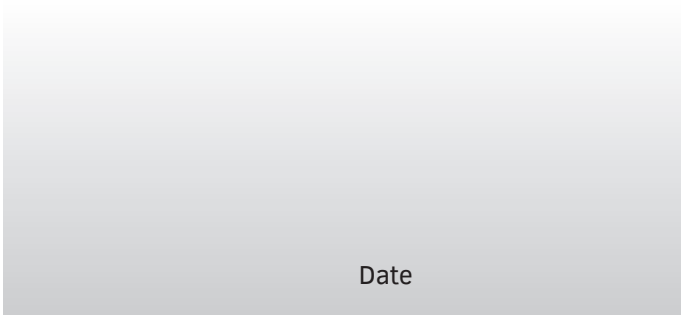

132 Months

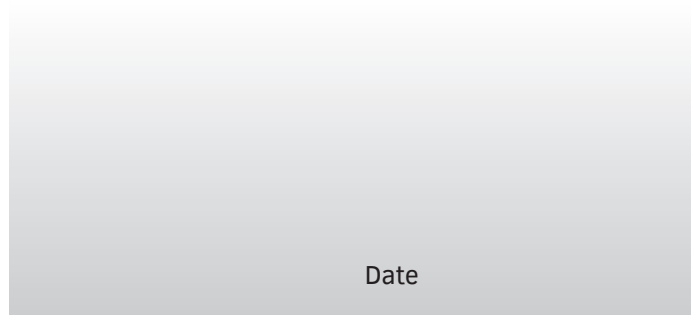

If you have registered online, this form is not necessary.
PLEASE POST THIS COPY TO THE ADDRESS OVERLEAF

Product Information (* Compulsory)

*Model No:	
*Product No:	
*Serial No:	
*Date of Purchase:	

Personal Information (* Compulsory)

*Title		*Forename		*Surname	
*House Number		*House Name			
*Address 1					
*Address 2					
*Town					
*County					
*Postcode					
Home Tel				Mobile Tel	
Email					

Age	18 to 25	26 to 35	36 to 45	46 to 60	61 to 80	81 & over
*Usage	Domestic Use			Commercial/Professional/Hire Use		

*Dealer Stamp (if available)



*Selling Retailer (If dealer stamp not available)

*Dealer Name	
*Dealer Address	
*Date of Purchase	

Webb Lawnmowers privacy commitment to machine owners.
The information supplied, helps us to improve the products & services we provide, including information that we believe is relevant to your and/or your machine. We value your trust by giving us this information about yourself and we are committed to protecting your privacy.

Webb, its associated companies, authorised dealers or third parties working on our behalf may wish to contact you regarding **PRODUCT RECALLS** specific to your machine. Please advise how you wish to be contacted for this specific reason only:

Post Telephone Email

From time to time Webb, its associated companies, authorised dealers or third parties working on our behalf may wish to contact you regarding our products, services, offers or just opinions, which may be used for marketing, research or analysis purposes.
If you wish to be contacted by any of the following methods, please tick the relevant boxes:

Post Telephone Email

You may give Webb Lawnmowers notice in writing at any time that you no longer wish to receive direct marketing communications

Webb Lawnmowers
Murdock Road
Dorcan
Swindon
Wiltshire
SN3 5HY