

## WV 2 Plus D500

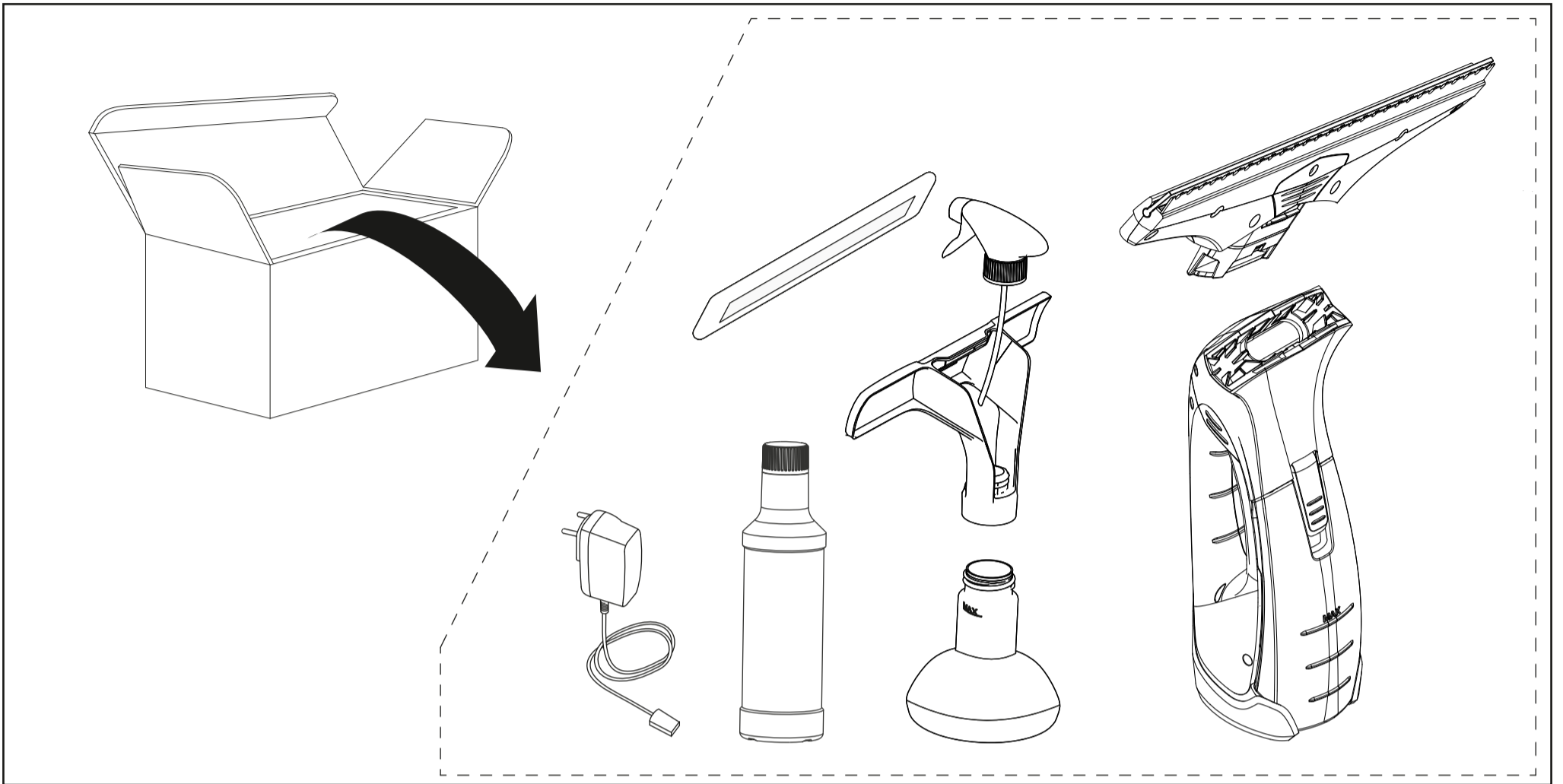

|   |                 |  |          |   |         |
|---|-----------------|--|----------|---|---------|
| <br>Li-Ion | 3,7 V           |  | IPX4     |  | 0,6 kg  |
| <br>nom    | 10 W            |  | 100 ml   |  | 185 min |
|            | 5,5 V<br>600 mA |  | 50 db(A) |  | 35 min  |

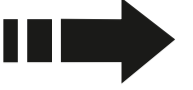
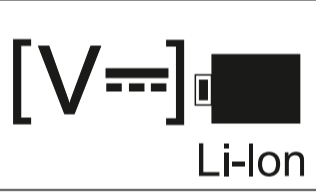
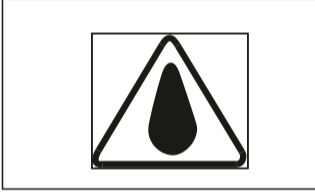
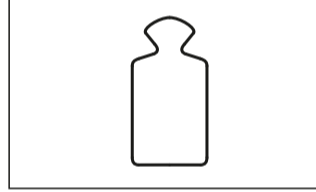
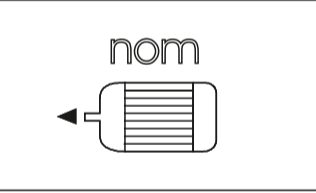
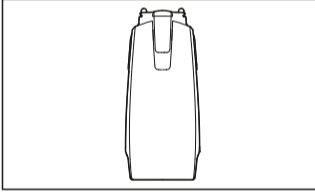
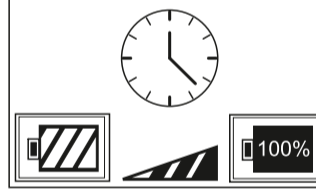
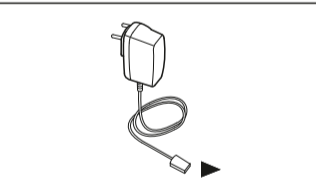
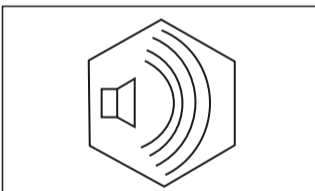
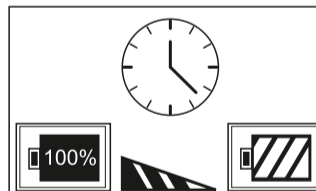