

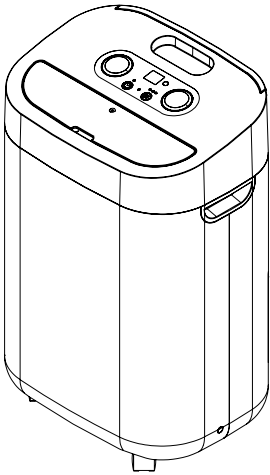

GoodHome

## Local air conditioner



3663602499879  
3663602499930  
**WAP-08EK13**

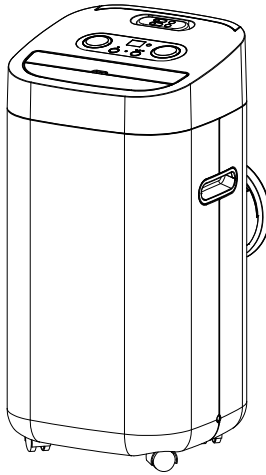

3663602499893  
3663602499954  
**WAP-12EK26**

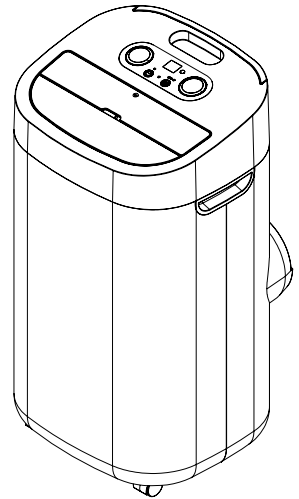

3663602499916  
3663602499978  
**WAP-07EK35H**

3663602499909  
3663602499961  
**WAP-12EK26H**



EN Safety

EN

4



EN Guarantee

EN

12



EN Preparation

EN

13



EN Product description

EN

14



EN Installation

EN

15



EN Use

EN

18



+



EN Care & maintenance

EN

22



EN Please read the following instructions carefully before using the appliance and retain for further reference.

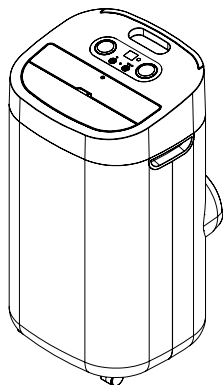

x1



x1

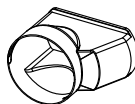

x1



x1



x3

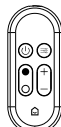

x1

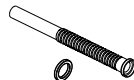

only for WAP-12EK26  
WAP-12EK26H

x1

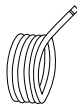

only for WAP-07EK35H

x1



x1



x1



 Safety



## **WARNING!**

**READ AND SAVE THESE INSTRUCTIONS BEFORE USING THIS PRODUCT.**

## **PLEASE READ THE FOLLOWING INSTRUCTIONS CAREFULLY BEFORE USING THE APPLIANCE AND RETAIN FOR FURTHER REFERENCE.**

- ☑ CAUTION - Fire, electric shock, physical injury and property damage hazards.
- ☑ To use the appliance, always follow the instructions for assembly, use and maintenance as well as usage cautions.
- ☑ Do not wet the housing or control panel.
- ☑ Do not cover the air outlet while in use.
- ☑ Do not allow children to play with the control or drop any objects into the air outlet.
- ☑ Do not place any objects or let any person sit on top of the unit.
- ☑ Always turn the unit off and remove the power plug from the socket when cleaning or for any other maintenance operation.
- ☑ Do not attempt to remove any part of the casing unless by an authorised technician.
- ☑ Remove the plug from the socket if the unit is not being used for a long period.
- ☑ Always connect this appliance to a 220-240 V~ mains power socket.
- ☑ Do not operate the unit with damaged plug or loose socket point.
- ☑ Please note this product has non serviceable parts. The coolant gas in this appliance cannot be replaced / regassed.

- ☑ This appliance can be used by children aged from 8 years and above and persons with reduced physical, sensory or mental capabilities or lack of experience and knowledge if they have been given supervision or instruction concerning use of the appliance in a safe way and understand the hazards involved.
- ☑ Children shall not play with the appliance.
- ☑ Cleaning and user maintenance shall not be made by children without supervision.
- ☑ Make sure that the back of the unit is at least 30 cm or more from a wall. Do not place the unit in front of curtains or drapes in case they fall against the back air intake.
- ☑ If the supply cord is damaged, it must be replaced by the manufacturer, its service agent or similarly qualified persons in order to avoid a hazard.
- ☑ If using this appliance with an extension lead do not exceed the maximum rated wattage of the extension lead.
- ☑ Do not use this appliance in bathrooms or wet room environments/locations.
- ☑ The appliance shall not be installed in a laundry room. Appliance must not be used in closed cupboards or changing rooms. Do not cover the appliance with clothing or any other fabric.
- ☑ Appliance must be kept at a suitable distance from walls, furniture and curtains to prevent them from overheating due to poor ventilation.
- ☑ Appliance should not be used when no one is at home. If you are away for long periods of time, turn off the power and remove the plug from the socket.
- ☑ The filter should be cleaned or replaced periodically to prevent insufficient air flow caused by a build-up of dust particles. Poor air flow will cause overheating, reduce the performance of the unit and add more risk.
- ☑ This appliance is designed for INDOOR DOMESTIC USE ONLY.
- ☑ Any person who is involved with working on or breaking into a refrigerant circuit should hold a current valid certificate from an industry-accredited assessment

authority, which authorises their competence to handle refrigerants safely in accordance with an industry recognised assessment specification.

- ☑ Servicing shall only be performed as recommended by the equipment manufacturer. Maintenance and repair requiring the assistance of other skilled personnel shall be carried out under the supervision of the person competent in the use of flammable refrigerants.
- ☑ **Important note for WAP-07EK35H:** Due to the power input of this product on start up, voltage drops may occur and this can influence other equipment (e.g. dimming lights). Therefore, we advise you to make sure that your product is only connected to a supply with a maximum permissible system impedance  $Z_{max}=0.240$  Ohm. If you require further clarification, you may contact your local power supply authority.

### **Battery warnings**

- ☑ An adult must carry out battery replacement and installation.
- ☑ Remove exhausted batteries from this product.
- ☑ Do not dispose of batteries in a fire, batteries may explode or leak.
- ☑ Do not short-circuit the battery terminals.
- ☑ Do not mix used and new batteries.
- ☑ Do not mix alkaline standard (carbon-zinc), lithium or rechargeable batteries.
- ☑ Do not mixed different types of batteries.
- ☑ Do not recharge non-rechargeable batteries.
- ☑ Do not allow water to come into contact with the batteries or wiring.
- ☑ Install carefully to prevent any damage to the batteries.
- ☑ Remove batteries from product when not in use for long periods of time.
- ☑ Store unused batteries in their original appliance packaging.
- ☑ Dispose of used batteries responsibly.



## WARNING!

Do not use means to accelerate the defrosting process or to clean, other than those recommended by the manufacturer.

The appliance shall be stored in a room without continuously operating ignition sources (for example: open flames, an operating gas appliance or an operating electric heater. Do not pierce or burn.

Be aware that refrigerants may not contain an odour, Appliance shall be installed, operated and stored in a room with a floor area larger than 10 m<sup>2</sup> (only for WAP-08EK13 / WAP-12EK26 / WAP-12EK26H) or 15 m<sup>2</sup> (only for WAP-07EK35H).

- ☑ Warning: Keep ventilation opening clear of obstruction.
- ☑ Warning: the appliance shall be stored in a well-ventilated area where the room size corresponds to the room area as specified for operation;
- ☑ Warning: the appliance shall be stored in a room without continuously operating open flames (for example an operating gas appliance) and ignition sources (for example an operating electric heater).
- ☑ Under no circumstances shall potential sources of ignition be used in the searching for or detection of refrigerant leaks. A halide torch (or any other detector using a naked flame) shall not be used.
- ☑ For leak detection, the use of detergents containing chlorine shall be avoided.
- ☑ If a leak is suspected, all naked flames shall be removed/ extinguished. Call the service agent immediately and keep far away from the product.
- ☑ If disposal or decommissioning is needed, please contact the service agent or authorized personal to do it. Do not dispose and decommission the product yourself.

- ✓ The appliance shall be installed in accordance with national wiring regulations;
- ✓ The maximum refrigerant charge amount: 300g.
- ✓ An unventilated area where the appliance using flammable refrigerants is installed shall be so constructed that should any refrigerant leak, it will not stagnate so as to create a fire or explosion hazard.
- ✓ The appliance shall be stored so as to prevent mechanical damage from occurring.
- ✓ Check that cabling will not be subject to wear, corrosion, excessive pressure, vibration, sharp edges or any other adverse environmental effects. The check shall also take into account the effects of aging or continual vibration from sources such as compressors or fans.
- ✓ The following leak detection methods are deemed acceptable for systems containing flammable refrigerants.
- ✓ Electronic leak detectors shall be used to detect flammable refrigerants, but the sensitivity may not be adequate, or may need re-calibration. (Detection equipment shall be calibrated in a refrigerant-free area.) Ensure that the detector is not a potential source of ignition and is suitable for the refrigerant used. Leak detection equipment shall be set at a percentage of the LFL of the refrigerant and shall be calibrated to the refrigerant employed and the appropriate percentage of gas (25 % maximum) is confirmed.
- ✓ Leak detection fluids are suitable for use with most refrigerants but the use of detergents containing chlorine shall be avoided as the chlorine may react with the refrigerant and corrode the copper pipe-work.
- ✓ If a leak is suspected, all naked flames shall be removed/ extinguished.
- ✓ If a leakage of refrigerant is found which requires brazing, all of the refrigerant shall be recovered from the system, or isolated (by means of shut off valves) in a part of the



system remote from the leak. Oxygen free nitrogen (OFN) shall then be purged through the system both before and during the brazing process.

- ☑ Before carrying out this procedure, it is essential that the technician is completely familiar with the equipment and all its detail. It is recommended good practice that all refrigerants are recovered safely. Prior to the task being carried out, an oil and refrigerant sample shall be taken in case analysis is required prior to re-use of reclaimed refrigerant. It is essential that electrical power is available before the task is commenced.
- ☑ Become familiar with the equipment and its operation.
- ☑ Isolate system electrically.
- ☑ Before attempting the procedure ensure that
- ☑ mechanical handling equipment is available, if required, for handling refrigerant cylinders;
- ☑ all personal protective equipment is available and being used correctly;
- ☑ the recovery process is supervised at all times by a competent person;
- ☑ recovery equipment and cylinders conform to the appropriate standards.
- ☑ Pump down refrigerant system, if possible.
- ☑ If a vacuum is not possible, make a manifold so that refrigerant can be removed from various parts of the system.
- ☑ Make sure that cylinder is situated on the scales before recovery takes place.
- ☑ Start the recovery machine and operate in accordance with manufacturer's instructions.
- ☑ Do not overfill cylinders. (No more than 80 % volume liquid charge).
- ☑ Do not exceed the maximum working pressure of the cylinder, even temporarily.
- ☑ When the cylinders have been filled correctly and the process completed, make sure that the cylinders and

the equipment are removed from site promptly and all isolation valves on the equipment are closed off.

- ☑ Recovered refrigerant shall not be charged into another refrigeration system unless it has been cleaned and checked.
- ☑ Equipment shall be labelled stating that it has been decommissioned and emptied of refrigerant. The label shall be dated and signed. Ensure that there are labels on the equipment stating the equipment contains flammable refrigerant.
- ☑ When removing refrigerant from a system either for servicing or decommissioning, it is recommended good practice that all refrigerants are removed safely.
- ☑ When transferring refrigerant into cylinders, ensure that only appropriate refrigerant recovery cylinders are employed. Ensure that the correct number of cylinders for holding the total system charge are available. All cylinders to be used are designated for the recovered refrigerant and labelled for that refrigerant (i.e. special cylinders for the recovery of refrigerant). Cylinders shall be complete with pressure relief valve and associated shut-off valves in good working order. Empty recovery cylinders are evacuated and, if possible, cooled before recovery occurs.
- ☑ The recovery equipment shall be in good working order with a set of instructions concerning the equipment that is at hand and shall be suitable for the recovery of flammable refrigerants. In addition, a set of calibrated weighing scales shall be available and in good working order. Hoses shall be complete with leak-free disconnect couplings and in good condition. Before using the recovery machine, check that it is in satisfactory working order, has been properly maintained and that any associated electrical components are sealed to prevent ignition in the event of a refrigerant release. Consult manufacturer if in doubt.

- ☑ The recovered refrigerant shall be returned to the refrigerant supplier in the correct recovery cylinder, and the relevant Waste Transfer Note arranged. Do not mix refrigerants in recovery units and especially not in cylinders.
  - ☑ If compressors or compressor oils are to be removed, ensure that they have been evacuated to an acceptable level to make certain that flammable refrigerant does not remain within the lubricant. The evacuation process shall be carried out prior to returning the compressor to the suppliers. Only electric heating to the compressor body shall be employed to accelerate this process. When oil is drained from a system, it shall be carried out safely.
- 



Read operator's manual.



Operator's manual  
operating instructions.



Service indicator;  
read technical manual.



Caution: risk of fire.



## Guarantee

We take special care to select high quality materials and use manufacturing techniques that allow us to create products incorporating design and durability. The Good Home Local air conditioner has a manufacturer's guarantee of 2 years against manufacturing defects, from the date of purchase (if bought in store) or date of delivery (if bought online), at no additional cost for normal (non-professional or commercial) household use.

To make a claim under this guarantee, you must present your proof of purchase (such as a sales receipt, purchase invoice or other evidence admissible under applicable law), please keep your proof of purchase in a safe place. For this guarantee to apply, the product you purchased must be new, it will not apply to second hand or display products. Unless stated otherwise by applicable law, any replacement product issued under this guarantee will only be guaranteed until expiry of the original period guarantee period.

This guarantee covers product failures and malfunctions provided the product was used for the purpose for which it is intended and subject to installation, cleaning, care and maintenance in accordance with the information contained in these terms and conditions, in the user manual and standard practice, provided that standard practice does not conflict with the user manual.

This guarantee does not cover defects and damage caused by normal wear and tear or damage that could be the result of improper use, faulty installation or assembly, neglect, accident, misuse, or modification of the product. Unless stated otherwise by applicable law, this guarantee will not cover, in any case, ancillary costs (shipping, movement, costs of uninstalling and reinstalling, labour etc), or direct and indirect damage.

If the product is defective, we will, within a reasonable time, refund.

Rights under this guarantee are enforceable in the country in which you purchased this product. Guarantee related queries should be addressed to the store you purchased this product from.

The guarantee is in addition to and does not affect your statutory rights.

If you purchased this product in France, in addition to this commercial guarantee, the vendor remains bound by the legal guarantee of conformity mentioned in articles L217-4 to L217-14 of the Code de la consommation and that relating to the hidden defects of the thing sold, under the conditions provided in articles 1641 to 1648 and 2232 of the Code civil. The distributor you purchased this product from is liable for any conformity or hidden defects in the product in accordance with these provisions.

In accordance with article L217-16 of the Code de la consommation, when the purchaser asks the vendor, during the course of the sales guarantee which was granted to same at the time of purchase or repair of the movable property, restoration covered by the guarantee, any period of downtime of at least seven days shall be added to the remaining guarantee period. This period runs from the request for intervention by the purchaser or from the availability for repair of the goods in question, if such availability is after the intervention request. Legal guarantee of conformity (extract from the consumer Code): Article L217-4 of the Consumer Code - The vendor must deliver goods in conformity with the contract and is liable for the lack of compliance existing at the time of delivery. It is also responsible for the lack of compliance caused by the packaging, assembly instructions or installation when it is responsible for such under the contract or when it was carried out under its responsibility. Article L217-5 of the Consumer Code - the goods are in conformity with the contract: 1. If they are fit for the purpose usually expected for similar goods and, where appropriate: if they correspond to the description given by the vendor and possess the qualities presented by the vendor to the purchaser in the form of a sample or model; if they present qualities which a purchaser can legitimately expect with regard to the public declarations made by the vendor, by the manufacturer or by its representative, in particular in the advertising or labelling; 2. Or if they present the characteristics defined by mutual agreement by the Parties or are fit for any special use sought by the purchaser, brought to the attention of the vendor and which the latter agreed. Article L217-12 of the Consumer Code - resulting from the lack of compliance is limited to two years after delivery of the goods. Legal guarantee on latent defects (extract from the consumer Code): Article 1641 of the Civil Code - The vendor is bound by the guarantee as a result of hidden defects in the item sold which render same unfit for the use for which it was intended, or which reduce such use so much that the purchaser would not have bought it, or would have paid a lower price, if it had known about them. Article 1648 of the Civil Code (1st paragraph) - Any action resulting from latent defects must be brought by the purchaser within two years from discovery of the defect.

If you purchased this product in Poland, this guarantee shall not exclude, limit or suspend your entitlement arising from the legal provisions on warranty for defects of the thing sold.

If you purchased this product in Turkey or Romania, a guarantee certificate will be provided to you upon purchase.

If you purchased this product in Spain, the distributor will be liable for any conformity defects of the product according to the provisions established in Articles 114 to 124 of the Legislative Royal Decree 1/2007, dated November 16th, which approves the consolidated text of the General Consumer and User Protection Law and other complementary laws.

If you purchased this product in Portugal, the distributor is liable for any conformity defects of the product pursuant to the terms of the Warranty Law (Decree-Law No. 67/2003), amended by Decree-Law No. 84/2008.

If you purchased this product in Germany, in the store, the distributor is liable if it is defective under (section 312a (2) sentence 1,3 of the German Civil Code – "BGB", art.246 (1) (5) Introductory Act to the Civil Code – "EGBGB"); if you have purchased this product online, the distributor is liable if it is defective under (section 246a 1 (1) sentence 1, (8) Introductory Act of the Civil Code – "EGBGB").



## Preparation

# Selecting a location



### IMPORTANT!

- The Appliance is designed to operate 16°C-35°C (Cooling) / 10°C-25°C (Heating). The Appliance's performance may be greatly reduced if room temperatures exceed this temperature range.

- Before using the Appliance, place the unit UPRIGHT for at least 1 hour before use to allow the refrigerant to stabilize. If the unit was tilted on its side or upside-down during transportation, set the unit upright for 4 hours before use.
- For optimal efficiency, the Appliance must be operated in an enclosed area. Keep all doors, windows and other outside entrances to the room closed.
- Place the Appliance at least 30cm away from other objects (e.g. curtains or furniture) that may restrict airflow front or through the air vents of the unit.
- The Appliance must be positioned on a level floor.

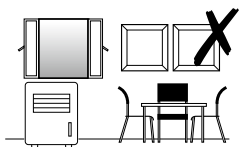
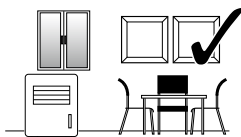

### IMPORTANT!

- The effectiveness of the Appliance can be influenced by different factors. One factor is the rate at which new, moisture-laden air enters the room and the amount of air circulating in and out of the area to be dehumidified. For example, if a door to a basement is constantly opened, letting new, moisture-laden air into the room, dehumidification will take longer than if the door was kept closed. If the Appliance is in a room with a storage closet or cabinets, it will have little or no effect in drying the inside of the storage closet or cabinets unless there is adequate circulation of air in and out of these places. To dehumidify these places, open the storage door or cabinet doors to allow air circulation. You may find that installing a second Appliance may be required for larger enclosed areas.

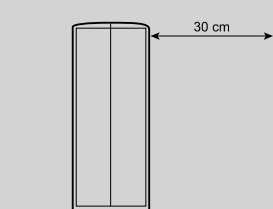



Product description

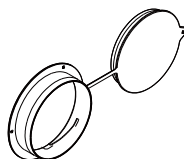
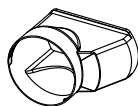
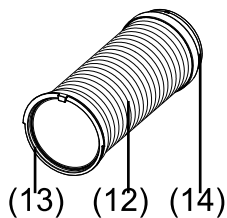
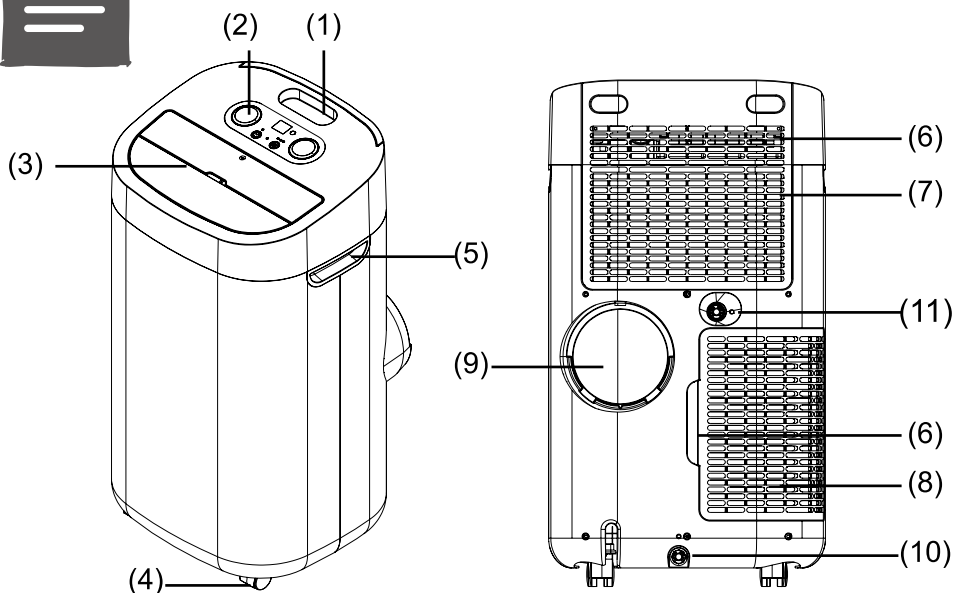

(13) (12) (14)

(15)

(16)

(17)

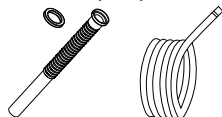
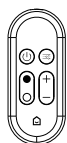

(18)

(left for WAP-12EK26,  
WAP-12EK26H only, right  
for WAP-07EK35H only)

(19)

(20)

(21)

- EN
1. Remote control storage facility
  2. Control panel
  3. Air outlet
  4. Wheels
  5. Handles
  6. Air filters x 2
  7. Air intake (Evaporator)
  8. Air intake (Condenser)
  9. Air outlet (Heat exchange)
  10. Water outlet drain
  11. Water outlet drain (WAP-12EK26, WAP-12EK26H, WAP-07EK35H Dehumidify mode only)
  12. Heat exhaust hose
  13. Exhaust connector (fix to unit)
  14. Exhaust connector (fix with nozzle)
  15. Exhaust nozzle
  16. Fixture & cap
  17. Screws x 3
  18. Remote control
  19. Hose (only for WAP-12EK26 WAP-12EK26H & WAP-07EK35H )
  20. Cable reel
  21. Hook



**EN** Installation

Connect the exhaust hose assembly to the back of the unit.

Extend hose (#12) to desired length and position the exhaust nozzle (#15) through an open window.

1. Click & lock the exhaust nozzle (#15) to the exhaust connector (#14). (Fig. 1)
2. Slide the exhaust connector (#13) to the air outlet (#9) on the rear of the unit. (Fig. 2)

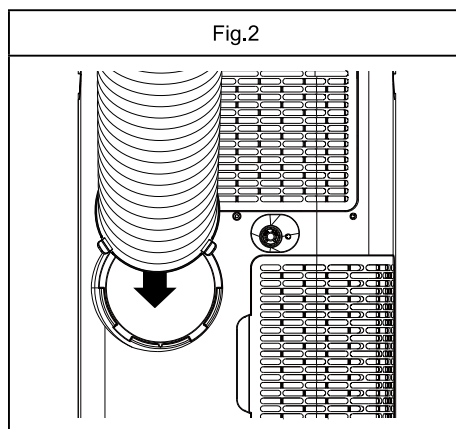
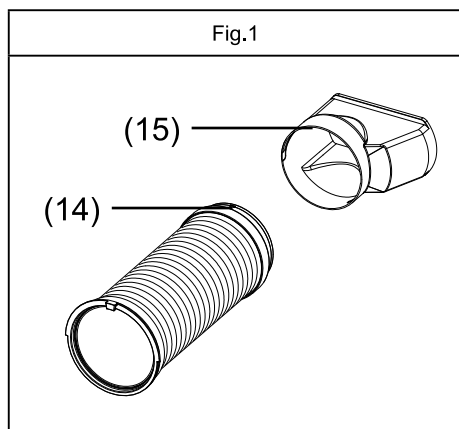

3. Extend the exhaust hose (#12) and close the window as far as possible trapping the exhaust nozzle (#15) as shown below.

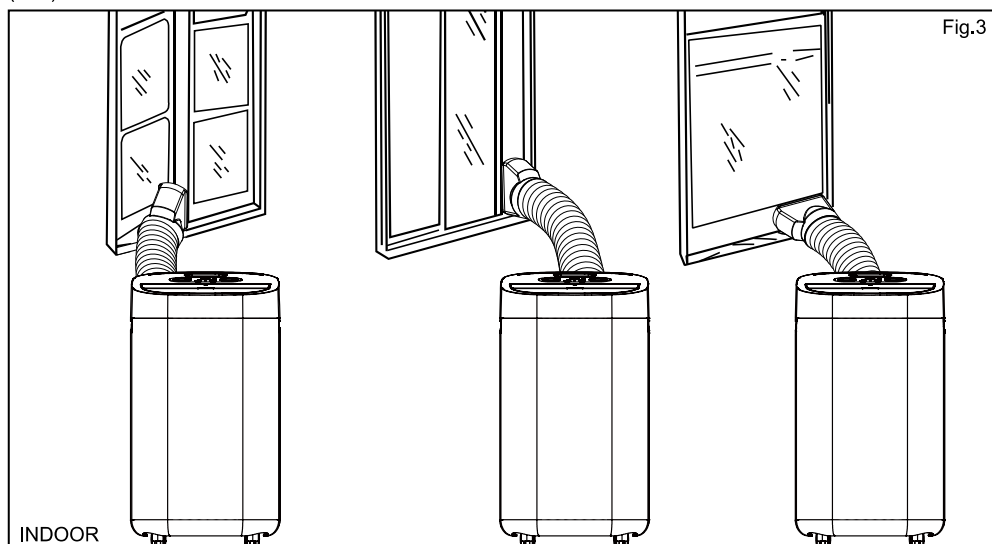

To properly insulate your room from outside warm air, use an insulation window kit (sold separately).

If required, your appliance can also be installed semi permanently (Fig. 4)

Proceed as follows:

- Drill a hole in an outside wall or through a window pane. Ensure the MIN / MAX dimensions for the hole size and its position are adhered to. (Fig. 5 and 6)
- Fit the flange accessory fixture (#16) provided in the hole .
- Still repeat step 1 & 2 in the former installation description, but not click the hose assembly to the exhaust nozzle (#15).
- Insert another end of the hose assembly to the fixture previously fit on the wall a shown in (Fig. 6)

When the hose is not in use, place the cap on connector to cover the hole.

#### NOTE:

When installing the air conditioner semi permanently, to maintain the balance of air pressure between indoors and outdoors always leave an internal door slightly open.

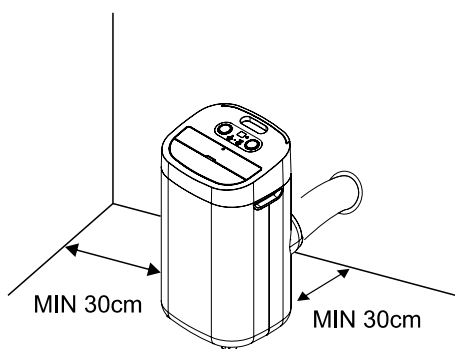

Fig. 4

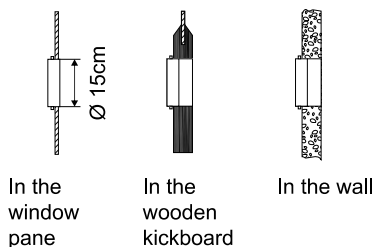
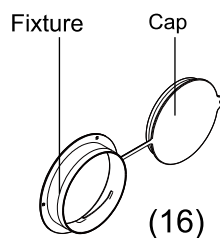

Fig. 5

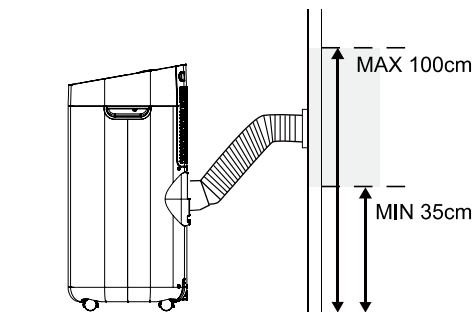

Fig. 6

Note: If the unit is to be used as a dehumidifier, do not connect the exhaust hose and let the warm air return to the room. You will need to install a drainage hose, with the water discharging to the outside.



# Continuous drainage (WAP-12EK26, WAP-12EK26H, WAP-07EK35H Dehumidify mode only) 17

Continuous drainage from the appliance can be achieved, if required, when there is an accessible drainage point nearby.

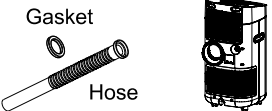
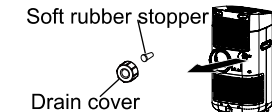
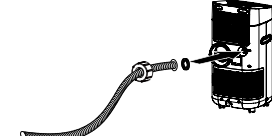

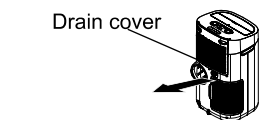
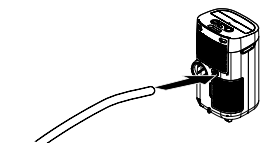
| For WAP-12EK26, WAP-12EK26H only  |  |
|---|--|
| <p>1. Use the adaptor attached on the back of unit together with hose and gasket to drain out water when dehumidify mode.</p>   | <p style="text-align: right;">Back of the unit</p>  <p>Gasket<br/>Hose</p> |
| <p>2. Take out drain cover from the drainage outlet .<br/>3. Remove the soft rubber stopper inside the drain cover. Store the soft rubber stopper in a safe place in order not to lose it. Plug it again on the drainage outlet once dehumidifying operation is finished.</p> |  <p>Soft rubber stopper<br/>Drain cover</p>                                |
| <p>4. Pass the drainage pipe end without gasket through the drain cover.<br/>5. Screw the drain cover clockwise onto the rear of the unit</p>   |    |

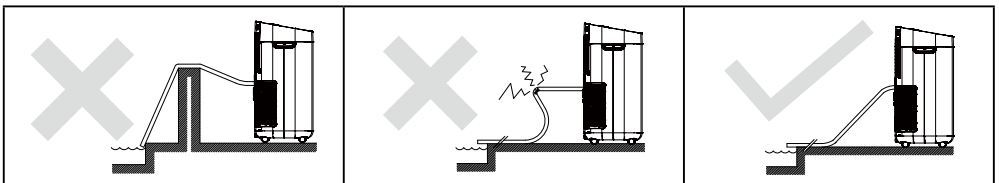
| For WAP-07EK35H only                                     |   |
|--|---|
| <p>1. Use the attached hose to drain out water</p>       | <p style="text-align: right;">Back of the unit</p>  <p>Hose</p> |
| <p>2. Take out drain cover from the drainage outlet.</p> |  <p>Drain cover</p>   |
| <p>3. Connect the hose with the drainage outlet.</p>     |   |

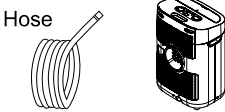

# Continuous drainage (For WAP-08EK13 Dehumidify mode) <sup>18</sup>

Continuous drainage from the appliance can be achieved, if required, when there is an accessible drainage point nearby.

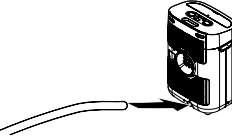
|  |   |
|--|---|
| <p>1. Prepare a <math>\varnothing</math>13mm hose (not included) to drain out water.</p> | <p>Back of the unit</p>  <p>Hose</p> |
| <p>2. Take out drain cover from the drainage outlet.</p>                                 |  <p>Drain cover</p>                  |
| <p>3. Connect the hose with the drainage outlet.</p>                                     |                                      |



Use

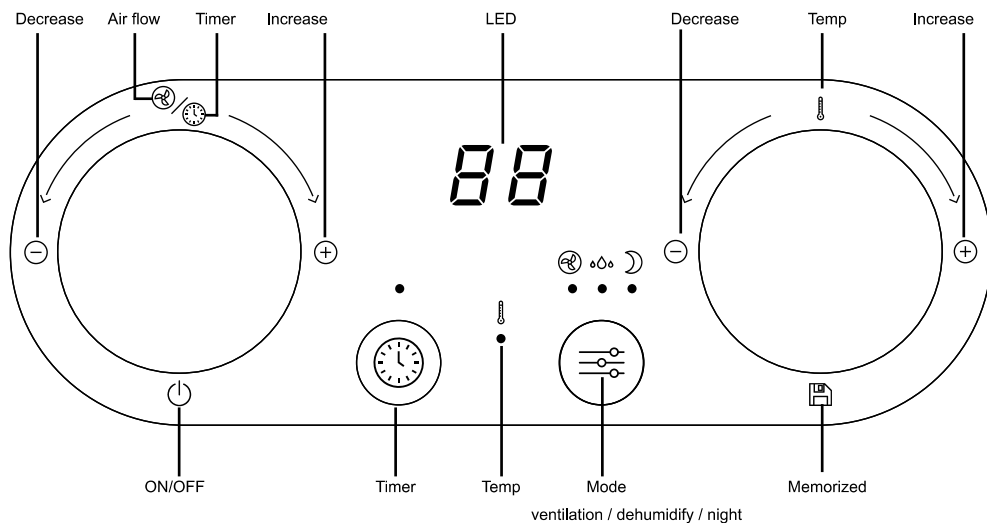

Mode

Timer

Temp indicator

Ventilation

Dehumidifier

Night



You will hear a beep at the first time the appliance is plugged in and the LED is on for around 3 seconds and then goes off. Please kindly open the air outlet (#3) manually before turning on the appliance.

## 1. ON/OFF

When the appliance is power off, long press (3sec.) the airflow/timer knob to switch on the appliance. "ON" **07** inscription will show on the display for 3 sec, then the LED screen shows the default temperature 22° **22**, and the temp indicator light is on.

Long press the airflow/timer knob to switch off the appliance, "OF" **0F** inscription will show on the display.

## 1. Setting temperature program in free mode and night mode

Press the mode button  till all the indicator lights for the ventilation/dehumidifier/night mode are off or only the night indicator light is on, then turn clockwise or anticlockwise the temp knob  to increase or decrease the temperature, the temperature is set after LED screen flash 3sec. The LED shows the setting temperature.

1) If the ambient temperature is lower than the setting temperature, the appliance operates in the heating mode and the temp indicator light becomes red  ;

Note: This is only applicable for the appliance with the heating function (WAP-07EK35H & WAP-12EK26H). No such function for cooling only appliance.

2) If the ambient temperature is higher than the setting temperature, the appliance operates in the cooling mode and the temp indicator light becomes blue  ;

3) If the ambient temperature within  $\pm 2^{\circ}\text{C}$  of the setting temperature, the compressor stops working, the temp indicator light turns off.



P.S: The maximum setting temperature is  $30^{\circ}\text{C}$ . The minimum setting temperature is  $16^{\circ}\text{C}$ . The temperature setting increment is  $1^{\circ}\text{C}$ . The compressor resumes working again when the difference between the setting temperature and the ambient temperature is greater than  $\pm 2^{\circ}\text{C}$

## **2. Setting air flow level program**

When the LED screen shows setting temperature, you can turn clockwise or anticlockwise the air flow/timer knob  to increase or decrease the air flow level, the LED screen shows the increasing or decreasing air flow level. The air flow level is set after LED screen flashes 3 seconds.

P.S: The maximum setting airflow level is 2 for WAP-08EK13 and 3 for WAP-07EK35H, WAP-12EK26 WAP-12EK26H. The minimum setting air flow is 1. The airflow increment is 1.

## **3. Setting ventilation mode**

Press the mode button  till the ventilation indicator light is on, the LED screen show the the airflow level (flash 3sec.), you can turn clockwise or anticlockwise the air flow/timer knob  to increase or decrease the air flow level. The air flow is validated after 3sec, then the LED screen shows the airflow setting (1,2 or 3)

## **4. Setting dehumidifier mode**

Press the mode button  till the dehumidifier indicator light is on, on the LED screen shows "H2" and flashes for 3seconds. Then the screen keeps the "H2" . In the dehumidifier mode, the temperature can not be set again but the air flow can be adjusted (when the room temperature is higher than 25 degree) by turning

clockwise or anticlockwise the air flow/timer knob  directly.

Note: In the dehumidifier mode, please always disconnect the exhaust hose from the unit.



To drain water, either you can refer to the instruction in “air conditioner storage” for all models, or the instruction for continuous drainage for WAP-12EK26, WAP-12EK16H and WAP-07EK35H.

## 5. Setting night mode



Press the mode button , the night mode indicator light is on, the LED screen shows the last setting temperature or the default temperature **22** and flashes 3 seconds before getting dim.

Note: In the night mode, the fan speed can't be adjusted and appliance will be extremely quiet. The setting temperature will gradually rise/ decrease 1 °C in every 2 hours (depending on the cooling or heating mode you choose) and keep constant after 2 °C increment or decrease until the unit is turned off or the night mode is cancelled.

## 6. Setting timer mode

- **When the appliance is running mode**, press the timer mode button , the LED screen shows the hours number (if it shows “OF” **0F**, press again the timer mode button till the hours number occurs). Turn clockwise or anticlockwise the air flow/timer knob  to increase or decrease the desired time delay OFF hours (1-24hours), the LED screen will flash 3 seconds before timer setting is validated;

If you want to cancel the timer setting, press the timer mode button  then the LED screen shows “OF” **0F** and the timer indicator light will be off.

When the appliance is OFF mode, press the timer mode button , the LED screen shows the hours number. Turn clockwise or anticlockwise the air flow/timer knob  to increase or decrease the desired time delay ON hours(1-24hours), the LED screen will flash 3 seconds before timer setting validate.

You can press the mode button  for other setting like Temperature, Ventilation, Dehumidifier and Night program, please ref to the above 1~5 setting step.

- P.S: Once the program is set, the timer LED start to “twinkle”, the LED screen shows the countdown time before the appliance start working.

- The maximum setting time is 24H. The minimum setting time is 1H.

## 2. Others

### 1. Water Full

When the LED screen shows “FU” *FU* inscription and the appliance starts an alarm for 10 seconds the water tank inside the appliance is full. You need to remove the blockage of the drain outlet (#10) and drain the water in the internal water tank.

### 2. Memory program

Long press(3sec.) the temp knob  , “Pr” inscription will appear on the LED screen and flashes 3sec. The appliance will memory the current setting of the appliance.

### 3. Launch Memory program

Short press the temp knob  , “Pr” inscription will appear on the LED screen and flash 3 seconds, then the appliance will resume the setting that was memorized in last step and the LED screen will display temperature setting and or the modes information accordingly etc.

### Remote control

The remote control requires 2 x AAA size batteries (not included).

Open the battery compartment by open the remote control rear cover by inserting a proper tool such as screwdriver or coin into the side slot (s) to pull the rear cover and insert the batteries noting the polarity indicated in the battery compartment. Remote control operations are identical to the functions on the control panel.

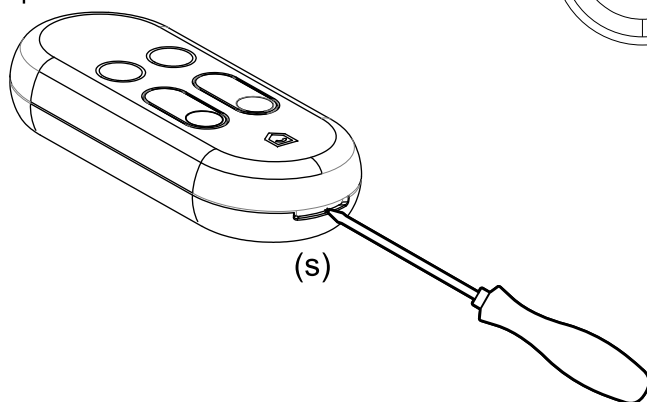
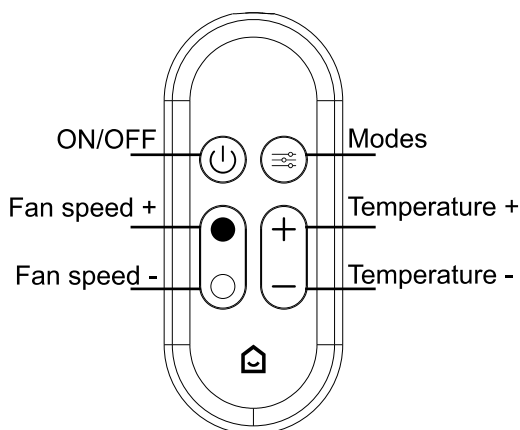



 Care & maintenance

## Maintenance and cleaning

1. Switch off and unplug from the power supply before assembling or disassembling and cleaning.
2. Do not allow water to drip on or into the air conditioner motor housing.
3. We also recommend the periodic cleaning of this air conditioner by lightly running a vacuum cleaner nozzle over to remove any dust or dirt that may have accumulated inside or on the unit.

## Air conditioner housing cleaning

Using a soft, moist cloth, with or without a mild soap solution, carefully clean the air conditioner housing. Please use caution around the air intakes and outlet. Do not allow the motor or other electrical components to be exposed to water.

Caution: Do not use harsh detergents, chemical cleaners or solvents as they may damage the surface finish of the plastic components.

## Air filters maintenance

It's necessary to clean the air filters after using it for about 100 hours.

Clean it as follows:

1. Turn the appliance off and remove the plug from the power socket. Remove the air filters.
2. Clean and reinstall the air filters (If the dirt is conspicuous, wash it with a solution of detergent in lukewarm water. After cleaning, dry it in a shaded and cool place then reinstall it)
3. Clean the air filters every two weeks if the air conditioner operates in an extremely dusty environment.

## Air conditioner storage

1. If the appliance is not planned to be used for a long time, ensure that any water is drained out. Remove the drain cover and rubber plug and allow the water to drain fully.
2. Before storing, run the appliance in the fan mode only for a few hours to dry any moisture on the coils. This will prevent the build up of mold during storage.
3. Stop the appliance, remove the plug from the wall socket and remove the batteries from the remote control, keeping them in safe place.
4. Clean the air filters and reinstall it.
5. Remove the exhaust hoses and store them safely. Securely cover any permanent holes in wall / windows.

Note: if you want to drainage the water from bottom drain outlet via a hose, prepare a  $\varnothing 13\text{mm}$  drain hose.

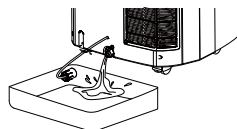

6. Remove the exhaust hose from the unit.
7. Install the cable reel #20 to the rear of the unit.

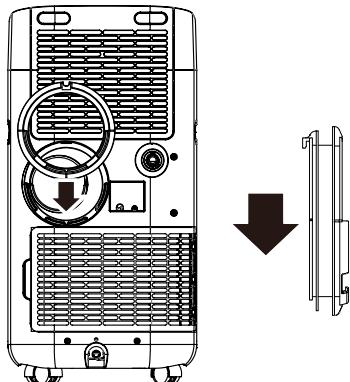

8. Wire the power cord anticlockwise around the reel until the end. Use the small open of the hook #21 to clamp the end of cable and the big open to clamp the available cable nearby.

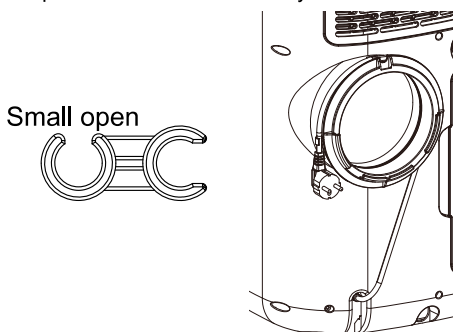

Your air conditioner can be stored in the off-season either partially disassembled or assembled. It is important to keep it in a safe, dry location.

- If stored disassembled, we recommend using the original (or appropriately sized) box.
- If stored assembled or partially assembled, remember to protect the air conditioner from dust.

## Plug Replacement

This appliance is supplied with a BS1363 3 pin plug fitted with a 13 Amp fuse. Should the fuse require replacement, it must be replaced with a fuse rated at 13 Amp and approved to BS1362. In the event the mains plug has to be removed/replaced for any reason, please note:

**IMPORTANT:** The wires in the mains lead are coloured in accordance with the following code:

Blue - Neutral

Brown - Live

Green/Yellow - Earth

As the colours of the wires in the mains lead of this appliance may not correspond with the coloured markings identifying the terminals in your plug, proceed as follows. The blue wire must be connected to the terminal marked with an N or coloured black.

The brown wire must be connected to the terminal marked with an L or coloured red.

The green/yellow wire must be connected to the earthing terminal which is marked with an E or with the earth symbol.

**WARNING:** Never connect live or neutral wires to the earth terminal of the plug. **NOTE:** If a moulded plug is fitted and has to be removed take great care in disposing of the plug and severed cable, it must be destroyed to prevent engaging into a socket.

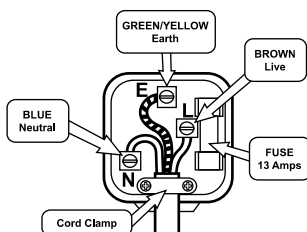

## Recycling



Waste electrical products should not be disposed of with household waste. Please recycle where facilities exist. Check with your Local Authority or local store for recycling advice.

yyWxx: Manufacturing date code; year of manufacturing (20yy) and week of manufacturing (Wxx)



# Technical data

|  |                                |                |                       |
|--|--------------------------------|----------------|-----------------------|
| Model  | WAP-08EK13                     |                |                       |
| Power supply   | 220-240V~ 50Hz                 |                |                       |
| Rated power  | 510W                           |                |                       |
| Dehumidifying capacity                                     | 1.3 Litres/hour (30°C, 80%RH)  |                |                       |
| Airflow volume   | 200 m <sup>3</sup> /h          |                |                       |
| Refrigerant  | R290 / 200g                    |                |                       |
| Class I  |                                |                |                       |
| Dimensions   | 43.5 x 33.8 x 67 cm            |                |                       |
| Weight   | 19.4 kg                        |                |                       |
| Fuse type  | T3,15A,L,250V                  |                |                       |
| Working temperature  | 16°C-35°C                      |                |                       |
| Wiring diagram affixed inside the rear panel.              |                                |                |                       |
| Description  | Symbol                         | Value          | Unit                  |
| Rated capacity for cooling                                 | P <sub>rated</sub> for cooling | 1.3            | kW                    |
| Rated capacity for heating                                 | P <sub>rated</sub> for Heating | Not applicable | kW                    |
| Rated power input for cooling                              | P <sub>EER</sub>               | 0.5            | kW                    |
| Rated power input for heating                              | P <sub>cop</sub>               | Not applicable | kW                    |
| Rated energy efficiency ratio                              | EERd                           | 2.4            | -                     |
| Rated coefficient of performance                           | COPd                           | Not applicable | -                     |
| Power consumption in thermostat-off mode                   | P <sub>TO</sub>                | 1.0            | W                     |
| Power consumption in standby mode                          | P <sub>SB</sub>                | 0.5            | W                     |
| Electricity consumption of single duct appliances          | SD:Q <sub>SD</sub>             | 0.5            | kWh/h                 |
| Sound power level  | L <sub>WA</sub>                | 65             | dB(A)                 |
| Global warming potential                                   | GWP                            | 3              | kgCO <sub>2</sub> eq. |
| CO <sub>2</sub> equivalent of fluorinated greenhouse gases |                                | 0.0006         | MT                    |

|  |                                |                |                       |
|--|--------------------------------|----------------|-----------------------|
| Model  | WAP-12EK26                     |                |                       |
| Power supply   | 220-240V~ 50Hz                 |                |                       |
| Rated power  | 1050 W                         |                |                       |
| Dehumidifying capacity                                     | 2.5 Litres/hour (30°C, 80%RH)  |                |                       |
| Airflow volume   | 280 m <sup>3</sup> /h          |                |                       |
| Refrigerant  | R290 / 189g                    |                |                       |
| Class I  |                                |                |                       |
| Dimensions   | 38 x 37.6 x 76.1 cm            |                |                       |
| Weight   | 26.3 kg                        |                |                       |
| Fuse type  | T1A,L,250V                     |                |                       |
| Working temperature  | 16°C-35°C                      |                |                       |
| Wiring diagram affixed inside the rear panel.              |                                |                |                       |
| Description  | Symbol                         | Value          | Unit                  |
| Rated capacity for cooling                                 | P <sub>rated</sub> for cooling | 2.6            | kW                    |
| Rated capacity for heating                                 | P <sub>rated</sub> for Heating | Not applicable | kW                    |
| Rated power input for cooling                              | P <sub>EER</sub>               | 1.0            | kW                    |
| Rated power input for heating                              | P <sub>cop</sub>               | Not applicable | kW                    |
| Rated energy efficiency ratio                              | EERd                           | 2.6            | -                     |
| Rated coefficient of performance                           | COPd                           | Not applicable | -                     |
| Power consumption in thermostat-off mode                   | P <sub>TO</sub>                | 1.0            | W                     |
| Power consumption in standby mode                          | P <sub>SB</sub>                | 0.5            | W                     |
| Electricity consumption of single duct appliances          | SD:Q <sub>SD</sub>             | 1.0            | kWh/h                 |
| Sound power level  | L <sub>WA</sub>                | 65             | dB(A)                 |
| Global warming potential                                   | GWP                            | 3              | kgCO <sub>2</sub> eq. |
| CO <sub>2</sub> equivalent of fluorinated greenhouse gases |                                | 0.00054        | MT                    |

|  |   |         |                       |
|--|---|---------|-----------------------|
| Model  | WAP-12EK26H                               |         |                       |
| Power supply   | 220-240V~ 50Hz                            |         |                       |
| Rated power  | 1050W / 1050W (Cooling / Heating)         |         |                       |
| Dehumidifying capacity                                     | 2.5 Litres/hour (30°C, 80%RH)             |         |                       |
| Airflow volume   | 280 m <sup>3</sup> /h                     |         |                       |
| Refrigerant  | R290 / 189g                               |         |                       |
| Class I  |   |         |                       |
| Dimensions   | 38 x 37.6 x 76.1 cm                       |         |                       |
| Weight   | 26.5 kg                                   |         |                       |
| Fuse type  | T1A,L,250V                                |         |                       |
| Working temperature  | 16°C-35°C (Cooling) / 10°C-25°C (Heating) |         |                       |
| Wiring diagram affixed inside the rear panel.              |   |         |                       |
| Description  | Symbol                                    | Value   | Unit                  |
| Rated capacity for cooling                                 | P <sub>rated</sub> for cooling            | 2.6     | kW                    |
| Rated capacity for heating                                 | P <sub>rated</sub> for Heating            | 1.8     | kW                    |
| Rated power input for cooling                              | P <sub>EER</sub>                          | 1.0     | kW                    |
| Rated power input for heating                              | P <sub>cop</sub>                          | 0.8     | kW                    |
| Rated energy efficiency ratio                              | EERd                                      | 2.6     | -                     |
| Rated coefficient of performance                           | COPd                                      | 2.3     | -                     |
| Power consumption in thermostat-off mode                   | P <sub>TO</sub>                           | 1.0     | W                     |
| Power consumption in standby mode                          | P <sub>SB</sub>                           | 0.5     | W                     |
| Electricity consumption of single duct appliances          | SD:Q <sub>SD</sub>                        | 1.0     | kWh/h                 |
| Sound power level  | L <sub>WA</sub>                           | 65      | dB(A)                 |
| Global warming potential                                   | GWP                                       | 3       | kgCO <sub>2</sub> eq. |
| CO <sub>2</sub> equivalent of fluorinated greenhouse gases |   | 0.00054 | MT                    |

|  |   |        |                       |
|--|---|--------|-----------------------|
| Model  | WAP-07EK35H                               |        |                       |
| Power supply   | 220-240V~ 50Hz                            |        |                       |
| Rated power  | 1400W / 1300W (Cooling / Heating)         |        |                       |
| Dehumidifying capacity                                     | 3 Litres/hour (30°C, 80%RH)               |        |                       |
| Airflow volume   | 440 m <sup>3</sup> /h                     |        |                       |
| Refrigerant  | R290 / 300g                               |        |                       |
| Class I  |   |        |                       |
| Dimensions   | 44.5 x 40.3 x 81.7 cm                     |        |                       |
| Weight   | 36.3 kg                                   |        |                       |
| Fuse type  | T1A,L,250V                                |        |                       |
| Working temperature  | 16°C-35°C (Cooling) / 10°C-25°C (Heating) |        |                       |
| Wiring diagram affixed inside the rear panel.              |   |        |                       |
| Description  | Symbol                                    | Value  | Unit                  |
| Rated capacity for cooling                                 | P <sub>rated</sub> for cooling            | 3.5    | kW                    |
| Rated capacity for heating                                 | P <sub>rated</sub> for Heating            | 2.8    | kW                    |
| Rated power input for cooling                              | P <sub>EER</sub>                          | 1.4    | kW                    |
| Rated power input for heating                              | P <sub>cop</sub>                          | 1.2    | kW                    |
| Rated energy efficiency ratio                              | EERd                                      | 2.6    | -                     |
| Rated coefficient of performance                           | COPd                                      | 2.3    | -                     |
| Power consumption in thermostat-off mode                   | P <sub>TO</sub>                           | 1.0    | W                     |
| Power consumption in standby mode                          | P <sub>SB</sub>                           | 0.5    | W                     |
| Electricity consumption of single duct appliances          | SD:Q <sub>SD</sub>                        | 1.4    | kWh/h                 |
| Sound power level  | L <sub>WA</sub>                           | 65     | dB(A)                 |
| Global warming potential                                   | GWP                                       | 3      | kgCO <sub>2</sub> eq. |
| CO <sub>2</sub> equivalent of fluorinated greenhouse gases |   | 0.0009 | MT                    |

## Symbols



Conforms to all relevant European Directives.

# Troubleshooting guide

| Fault                                      | Reason  | Solution  |
|--|---|---|
| Unit does not run                          | <ul style="list-style-type: none"> <li>• Electronic card (PCB) is broken.</li> <li>• Protector might be tripped.</li> <li>• Fuse might be blown.</li> <li>• Batteries in the remote control are exhausted.</li> <li>• The plug is not properly inserted into the socket.</li> </ul>   | <ul style="list-style-type: none"> <li>• Call an electrician</li> <li>• Wait for 3 minutes then re-start the unit.</li> <li>• Call an electrician</li> <li>• Replace the batteries</li> <li>• Insert the plug properly into the socket</li> </ul>   |
| Unit stops during running                  | <ul style="list-style-type: none"> <li>• The set temperature is close to room temperature.</li> <li>• Air outlet might be blocked.</li> </ul>   | <ul style="list-style-type: none"> <li>• Lower the temperature setting</li> <li>• Remove the obstruction</li> </ul>   |
| Unit runs but no evident temperature drop. | <ul style="list-style-type: none"> <li>• Check if a door or window is open.</li> <li>• Check if there is another heating appliance working nearby, e.g. a heater.</li> <li>• Check if air filter is dirty.</li> <li>• Check if air outlet or intake has been blocked.</li> <li>• Check if set temperature is too high.</li> </ul> | <ul style="list-style-type: none"> <li>• Close the door and window as the appliance may be affected by the outside temperature.</li> <li>• Shut off the heating appliance</li> <li>• Clean the air filter</li> <li>• Remove the obstruction</li> <li>• Lower the temperature setting</li> </ul> |
| Unit stops working                         | <ul style="list-style-type: none"> <li>• Check if water full indicator light is on.</li> </ul>  | <ul style="list-style-type: none"> <li>• Drain the water from drain port at bottom of back panel. If unit still doesn't work, consult a qualified technician.</li> </ul>  |
| LED display "E1"                           | <ul style="list-style-type: none"> <li>• The temperature sensor error</li> </ul>  | <ul style="list-style-type: none"> <li>• Repair or replace*</li> </ul>  |
| LED display "E2"                           | <ul style="list-style-type: none"> <li>• The coil sensor error</li> </ul>   | <ul style="list-style-type: none"> <li>• Repair or replace*</li> </ul>  |
| LED display "E5"                           | <ul style="list-style-type: none"> <li>• MCU error</li> </ul>   | <ul style="list-style-type: none"> <li>• Replace the boards</li> </ul>  |

**\* Caution: Do not attempt to repair, disassemble or modify the appliance. There are no user-serviceable parts inside. We suggest you to contact your service agent or a professional electrician for any help.**

Manufacturer,Fabricant,Producent,  
Hersteller, Producător,Fabricante:  
Kingfisher International Products Limited  
3 Sheldon Square  
London  
W2 6PX  
United Kingdom

EU manufacturer:  
Kingfisher International Products B.V.  
Rapenburgerstraat 175E  
1011VM Amsterdam  
The Netherlands

Distributor: B&Q plc,  
Chandlers Ford, Hants,  
SO53 3LE United Kingdom  
www.diy.com

SFD Limited  
Trade House, Mead Avenue  
Yeovil  
BA22 8RT, United Kingdom  
www.screwfix.com

To view instruction manuals online,  
visit [www.kingfisher.com/products](http://www.kingfisher.com/products)  
Customer Helpline (Freephone)  
UK 0800 324 7818 [uk@kingfisherservice.com](mailto:uk@kingfisherservice.com)  
Eire 1800 932 230 [eire@kingfisherservice.com](mailto:eire@kingfisherservice.com)

Distributeur: Castorama France  
C.S. 50101 Templemars  
59637 Wattignies CEDEX  
www.castorama.fr

BRICO DÉPÔT  
30-32 rue de la Tourelle  
91310 Longpont-sur-Orge  
France  
www.bricodepot.com

Pour consulter les manuels d'instructions  
en ligne, rendez-vous sur le site  
[www.kingfisher.com/products](http://www.kingfisher.com/products)

Dystrybutor: Castorama Polska Sp. z o.o.  
ul. Krakowiaków 78, 02-255 Warszawa  
www.castorama.pl

Aby zapoznać się z instrukcją obsługi online,  
odwiedź stronę [www.kingfisher.com/products](http://www.kingfisher.com/products)

Distribuidor: Euro Depot España, S.A.U.  
c/ La Selva, 10 - Edificio Inblau A 1a Planta  
08820-El Prat de Llobregat  
www.bricodepot.es

Para consultar los manuales de instrucciones  
en línea, visite [www.kingfisher.com/products](http://www.kingfisher.com/products)

Distribuidor: Brico Depot Portugal SA  
Rua Castilho, 5 - 1 esquerdo, sala 13  
1250-066 Lisboa  
www.bricodepot.pt

Para consultar manuais de instruções online,  
visite [www.kingfisher.com/products](http://www.kingfisher.com/products)

Distributor: SC Bricostore România SA  
Calea Giule.ti 1-3, Sector 6, Bucureşti  
România  
www.bricodepot.ro

Praktiker Romania S.A.  
Splaiul Independentei Nr. 319 L si M, Cladirea  
Bruxelles,  
etaj 1, Sector 6, RO-060044, Bucureşti, România  
Tel: +40 021 204 71 00  
www.praktiker.ro

Pentru a consulta manualele de instrucţiuni  
online, vizitaţi [www.kingfisher.com/products](http://www.kingfisher.com/products)

Verteilen:Screwfix Direct Limited  
Mühlheimer Straße 153  
63075 Offenbach/Main  
www.screwfix.de

Besuchen Sie [www.kingfisher.com/products](http://www.kingfisher.com/products)  
um die Bedienungsanleitungen online  
anzusehen

Yetkili servis istasyonları ve yedek parça temini  
için aşağıda yer alan Koçtaş Müşteri Hattı ve  
Koçtaş Genel Müdürlük irtibat bilgilerinden  
faydalanınız.

İthalatçı Firma: KOÇTAŞ YAPI  
MARKETLERİ TİC. A.Ş.  
Taşdelen mah. Sırrı Çelik Bulvarı No: 5  
34788 Taşdelen/Çekmeköy/İSTANBUL  
Tel: +90 216 4300300  
Faks: +90 216 4844313  
[www.koctas.com.tr](http://www.koctas.com.tr)  
KOÇTAŞ MÜŞTERİ HİZMETLERİ  
0850 209 50 50

Kullanım kılavuzuna internet üzerinden ulaşmak  
için [www.kingfisher.com/products](http://www.kingfisher.com/products) adresini ziyaret  
edin

Импортер: ООО "Касторама РУС"  
Дербневская наб., дом 7, стр 8  
Россия, Москва, 115114  
[www.castorama.ru](http://www.castorama.ru)

Производитель: Каипинг Нью Вайдтех Электрик  
Ко., ЛТД  
Адрес: Ферст Билдинг №40 Ксинг Да Рoad,  
Шуико Таун, Каипинг Сити, Гуангдонг, КНР

Онлайн-версии руководств по  
эксплуатации доступны на странице  
[www.kingfisher.com/products](http://www.kingfisher.com/products)