

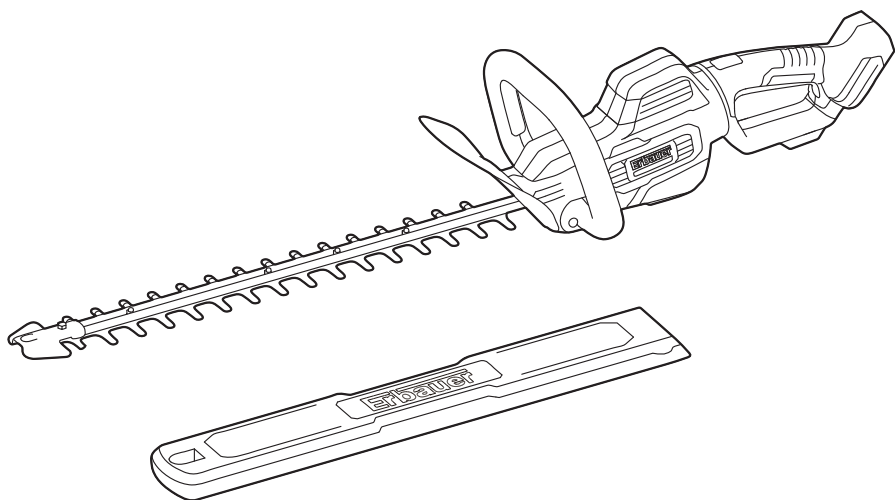

**Erbauer**



# EHT18-Li

EAN. 3663602418269

**EN** ORIGINAL INSTRUCTIONS





Product description



Safety instructions



Assembly



Use



+



Care & maintenance



Guarantee



Declaration of Conformity



**WARNING!** Please read all safety warnings carefully and be sure that they are fully understood before handling the tool.



## PRODUCT DESCRIPTION

1. Blade
2. Safety guard
3. Safety switch
4. Front handle
5. Air vents
6. Main handle
7. Battery pack release button\*
8. Power bar button\*
9. Battery pack\*
10. On/off switch
11. Angle adjustment button
12. Blade cover



**NOTE:** Parts marked with \* are not provided. Please refer to the respective section in the instruction manual.



# PRODUCT DESCRIPTION

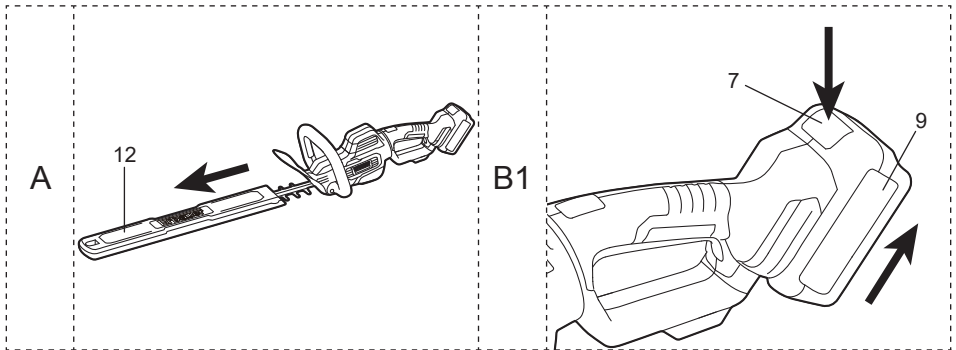
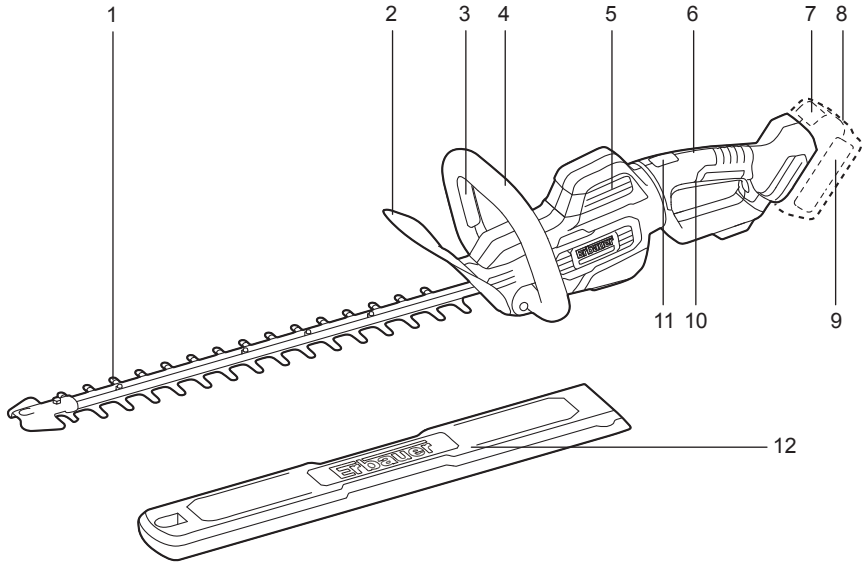

B2

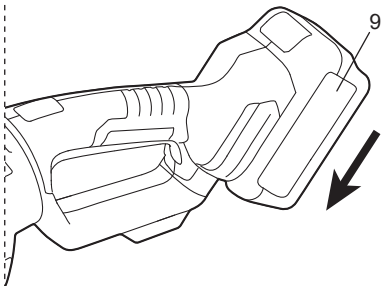

C

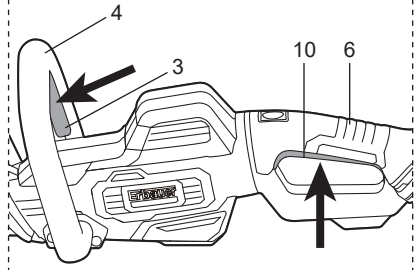

D1

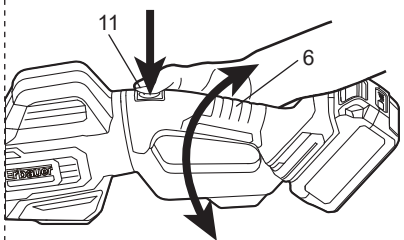

D2

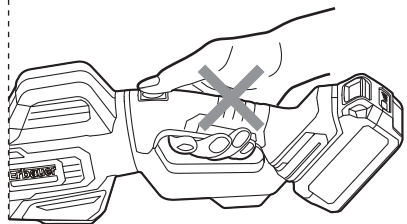

D3

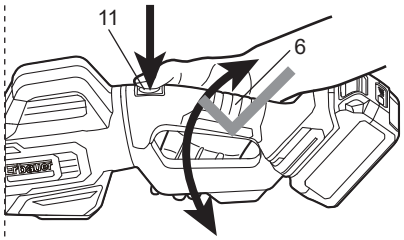

E

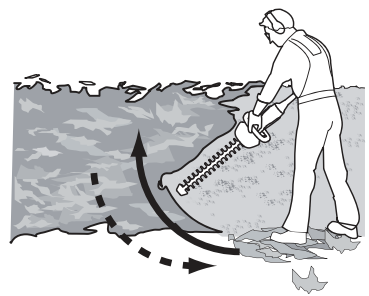

F

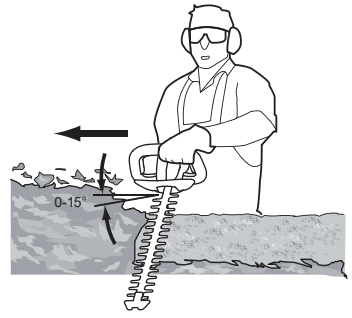

G

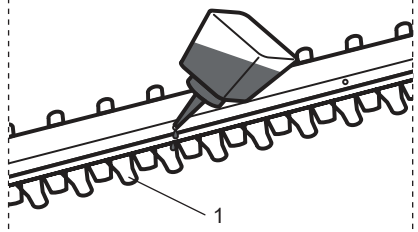



## SAFETY INSTRUCTIONS

### GENERAL POWER TOOL SAFETY WARNINGS



**WARNING!** Read all safety warnings, instructions, illustrations and specifications provided with this power tool. *Failure to follow all instructions listed below may result in electric shock, fire and/or serious injury.*

**Save all warnings and instructions for future reference.** *The term “power tool” in the warnings refers to your mains-operated (corded) power tool or battery operated (cordless) power tool.”*

### WORK AREA SAFETY

- a. **Keep work area clean and well lit.** *Cluttered or dark areas invite accidents.*
- b. **Do not operate power tools in explosive atmospheres, such as in the presence of flammable liquids, gases or dust.** *Power tools create sparks which may ignite the dust or fumes.*
- c. **Keep children and bystanders away while operating a power tool.** *Distractions can cause you to lose control.*

### ELECTRICAL SAFETY

- a. **Power tool plugs must match the outlet. Never modify the plug in any way. Do not use any adapter plugs with earthed (grounded) power tools.** *Unmodified plugs and matching outlets will reduce risk of electric shock.*
- b. **Avoid body contact with earthed or grounded surfaces, such as pipes, radiators, ranges and refrigerators.** *There is an increased risk of electric shock if your body is earthed or grounded.*

- c. **Do not expose power tools to rain or wet conditions.** *Water entering a power tool will increase the risk of electric shock.*
- d. **Do not abuse the cord. Never use the cord for carrying, pulling or unplugging the power tool. Keep cord away from heat, oil, sharp edges or moving parts.** *Damaged or entangled cords increase the risk of electric shock.*
- e. **When operating a power tool outdoors, use an extension cord suitable for outdoor use.** *Use of a cord suitable for outdoor use reduces the risk of electric shock.*
- f. **If operating a power tool in a damp location is unavoidable, use a residual current device (RCD) protected supply.** *Use of an RCD reduces the risk of electric shock.*

## PERSONAL SAFETY

- a. **Stay alert, watch what you are doing and use common sense when operating a power tool. Do not use a power tool while you are tired or under the influence of drugs, alcohol or medication.** *A moment of inattention while operating power tools may result in serious personal injury.*
- b. **Use personal protective equipment. Always wear eye protection.** *Protective equipment such as a dust mask, non-skid safety shoes, hard hat, or hearing protection used for appropriate conditions will reduce personal injuries.*
- c. **Prevent unintentional starting. Ensure the switch is in the off- position before connecting to power source and/or battery pack, picking up or carrying the tool.** *Carrying power tools with your finger on the switch or energising power tools that have the switch on invites accidents.*
- d. **Remove any adjusting key or wrench before turning the power tool on.** *A wrench or a key left attached to a rotating part of the power tool may result in personal injury.*
- e. **Do not overreach. Keep proper footing and balance at all times.** *This enables better control of the power tool in unexpected situations.*

- f. **Dress properly. Do not wear loose clothing or jewellery. Keep your hair and clothing away from moving parts. *Loose clothes, jewellery or long hair can be caught in moving parts.***
- g. **If devices are provided for the connection of dust extraction and collection facilities, ensure these are connected and properly used. *Use of dust collection can reduce dust-related hazards.***
- h. **Do not let familiarity gained from frequent use of tools allow you to become complacent and ignore tool safety principles. *A careless action can cause severe injury within a fraction of a second.***

## **POWER TOOL USE AND CARE**

- a. **Do not force the power tool. Use the correct power tool for your application. *The correct power tool will do the job better and safer at the rate for which it was designed.***
- b. **Do not use the power tool if the switch does not turn it on and off. *Any power tool that cannot be controlled with the switch is dangerous and must be repaired.***
- c. **Disconnect the plug from the power source and/or remove the battery pack, if detachable, from the power tool before making any adjustments, changing accessories, or storing power tools. *Such preventive safety measures reduce the risk of starting the power tool accidentally.***
- d. **Store idle power tools out of the reach of children and do not allow persons unfamiliar with the power tool or these instructions to operate the power tool. *Power tools are dangerous in the hands of untrained users.***
- e. **Maintain power tools and accessories. Check for misalignment or binding of moving parts, breakage of parts and any other condition that may affect the power tool's operation. If damaged, have the power tool repaired before use. *Many accidents are caused by poorly maintained power tools.***



- f. **Keep cutting tools sharp and clean.** *Properly maintained cutting tools with sharp cutting edges are less likely to bind and are easier to control.*
- g. **Use the power tool, accessories and tool bits etc. in accordance with these instructions, taking into account the working conditions and the work to be performed.** *Use of the power tool for operations different from those intended could result in a hazardous situation.*
- h. **Keep handles and grasping surfaces dry, clean and free from oil and grease.** *Slippery handles and grasping surfaces do not allow for safe handling and control of the tool in unexpected situations.*

## **BATTERY TOOL USE AND CARE**

- a. **Recharge only with the charger specified by the manufacturer.** *A charger that is suitable for one type of battery pack may create a risk of fire when used with another battery pack.*
- b. **Use power tools only with specifically designated battery packs.** *Use of any other battery packs may create a risk of injury and fire.*
- c. **When battery pack is not in use, keep it away from other metal objects, like paper clips, coins, keys, nails, screws or other small metal objects, that can make a connection from one terminal to another.** *Shorting the battery terminals together may cause burns or a fire.*
- d. **Under abusive conditions, liquid may be ejected from the battery; avoid contact. If contact accidentally occurs, flush with water. If liquid contacts eyes, additionally seek medical help.** *Liquid ejected from the battery may cause irritation or burns.*
- e. **Do not use a battery pack or tool that is damaged or modified.** *Damaged or modified batteries may exhibit unpredictable behaviour resulting in fire, explosion or risk of injury.*

- f. **Do not expose a battery pack or tool to fire or excessive temperature.** *Exposure to fire or temperature above 130 °C may cause explosion.*
- g. **Follow all charging instructions and do not charge the battery pack or tool outside the temperature range specified in the instructions.** *Charging improperly or at temperatures outside the specified range may damage the battery and increase the risk of fire.*

## SERVICE

- a. **Have your power tool serviced by a qualified repair person using only identical replacement parts.** *This will ensure that the safety of the power tool is maintained.*
- b. **Never service damaged battery packs.** *Service of battery packs should only be performed by the manufacturer or authorized service providers.*

## HEDGE TRIMMER SAFETY WARNINGS

- a. **Keep all parts of the body away from the cutter blade. Do not remove cut material or hold material to be cut when blades are moving. Make sure the switch is off when clearing jammed material.** *A moment of inattention while operating the hedge trimmer may result in serious personal injury.*
- b. **Carry the hedge trimmer by the handle with the cutter blade stopped. When transporting or storing the hedge trimmer always fit the cutting device cover.** *Proper handling of the hedge trimmer will reduce possible personal injury from the cutter blades.*
- c. **Hold the power tool by insulated gripping surfaces only, because the cutter blade may contact hidden wiring.** *Cutter blades contacting a “live” wire may make exposed metal parts of the power tool “live” and could give the operator an electric shock.*

- d. **Check the hedge for foreign objects before operation, e.g. wire fences.** *Take care that the cutting device does not come into contact with wire or other metal objects.*
- e. **Hold the hedge trimmer properly, e.g. with both hands if two handles are provided.** *Loss of control can cause personal injury.*

## **ADDITIONAL SAFETY WARNINGS FOR HEDGE TRIMMER**

- a. *Keep hands and feet away from the cutting devices at all times and especially when switching the product on.*
- b. *Do not try to grasp or remove trimmings when the product is running. Only remove trimmings when the product is switched off and remove the battery pack.*
- c. *Never hold the product by the guard.*
- d. *Always be sure of a safe and secure operating position, whilst using the product. Always be sure of your footing when using steps and when using your product.*
- e. *Never use the product standing on steps or a ladder. Do not work over shoulder height.*
- f. *Always ensure the safety guard supplied is fitted before using the product. Never attempt to use an incomplete product or one fitted with an unauthorized modification.*
- g. *Check cutting device regularly for damage, and if damaged repair immediately.*
- h. *Do not overload the product.*
- i. *Check immediately if the product starts to vibrate abnormally. Excessive vibration can cause injury.*
- j. *Switch the product off when the cutting device is blocked. Remove the battery pack and clear the blockage. Inspect the cutting device for damage before using the product again.*
- k. *Follow the maintenance and repair instructions for this product. Never carry out any modifications of the product. Information about maintenance and repair is provided in this user manual.*

- l. Know how to stop the product quickly in an emergency.*
- m. Do not expose to rain. Do not operate the product on a wet hedge.*
- n. Use the product only in daylight or good artificial light.*
- o. Prolonged use of the product exposes the user to vibrations that can cause a range of conditions collectively known as hand-arm vibration syndrome (HAVS) e.g. fingers going white; as well as specific diseases such as carpal tunnel syndrome.*
- To reduce this risk when using the product, always wear protective gloves and keep your hands warm.
- The symptoms of HAVS include any combination of the following: Tingling and numbness in the fingers; Not being able to feel things properly; Loss of strength in the hands; Fingers going white (blanching) and becoming red and painful on recovery (particularly in the cold and wet, and probably only in the tips at first). Seek medical advice immediately if such symptoms are experienced.

## **VIBRATION AND NOISE REDUCTION**

To reduce the impact of noise and vibration emission, limit the time of operation, use low-vibration and low-noise operating modes as well as wear personal protective equipment.

Take the following points into account to minimize the vibration and noise exposure risks:

- a. Only use the product as intended by its design and these instructions.*
- b. Ensure that the product is in good condition and well maintained.*
- c. Use correct cutting attachments for the product and ensure they in good condition.*
- d. Keep tight grip on the handles/grip surface.*
- e. Maintain this product in accordance with these instructions and keep it well lubricated (where appropriate).*

- f. Plan your work schedule to spread any high vibration tool use across a longer period of time.*

## EMERGENCY

Familiarise yourself with the use of this product by means of this instruction manual. Memorise the safety directions and follow them to the letter. This will help to prevent risks and hazards.

- a. Always be alert when using this product, so that you can recognise and handle risks early. Fast intervention can prevent serious injury and damage to property.*
- b. Switch off and disconnect from the power supply if there are malfunctions. Have the garden power tool checked by a qualified professional and repaired, if necessary, before you operate it again.*

## RESIDUAL RISKS

Even if you are operating this product in accordance with all the safety requirements, potential risks of injury and damage remain. The following dangers can arise in connection with the structure and design of this product:

- a. Health defects resulting from vibration emission if the product is being used over long periods of time or not adequately managed and properly maintained.*
- b. Injuries and damage to property due to broken cutting attachments or the sudden impact of hidden objects during use.*
- c. Danger of injury and property damage caused by flying objects.*



**WARNING!** This product produces an electromagnetic field during operation! This field may under some circumstances interfere with active or passive medical implants! To reduce the risk of serious or fatal injury, we recommend persons with medical implants to consult their doctor and the medical implant manufacturer before operating this product!



## ASSEMBLY

### 01 UNPACKING

- Unpack all parts and lay them on a flat, stable surface.
- Remove all packing materials and shipping devices, if applicable.
- Make sure the delivery contents are complete and free of any damage. If you find that parts are missing or show damage do not use the product but contact your dealer. Using an incomplete or damaged product represents a hazard to people and property.
- Ensure that you have all the accessories and tools needed for assembly and operation. This also includes suitable personal protective equipment



**WARNING!** The product and the packaging are not children's toys!  
Children must not play with plastic bags, sheets and small parts! There is a danger of choking and suffocation!

### 02 ASSEMBLY

#### BLADE COVER (FIG. A)

Remove the blade cover(12) from the cutting device.

#### CHARGING YOUR BATTERY PACK

The battery has been shipped in a low charge condition. Charge it fully before first use. Refer to the charger instruction manual for the details.







#### TO REMOVE OR INSTALL THE BATTERY PACK (FIG. B1, B2)

Depress the battery pack release button (7) to release and slide the battery pack out from your tool.

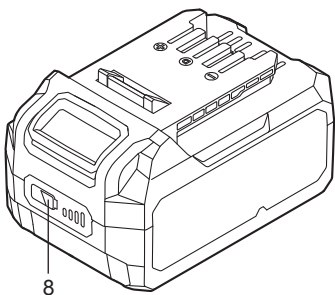
After recharge, slide it back into your tool. A simple push and slight pressure will be sufficient.

#### BATTERY PACK POWER BAR

The Li-Ion battery pack (9) is equipped with a POWER BAR (8) which is used to give an indication of the battery pack's remaining charge. Press the POWER BAR button (8) to check battery charge as below. The LED will stay lit for approximately 5 seconds.

 <p>8</p> <p>Flash      On      Off</p>	76-100% Charge	
	51-75% Charge	
	26-50% Charge	
	5-25% Charge	
	under 5% Charge	



## USE

### 01 INTENDED USE

The product is intended for trimming hedges, bushes and shrubs. Observe the technical data for the maximum cutting capacity. Do not cut non-plant material or branches exceeding the stated maximum capacity.

### 02 OPERATION

#### ON/OFF SWITCH (FIG. C)

Hold the product with one hand at the main handle(6) and with the other at the front handle(4).

Press the on/off switch(10) and the safety switch(3) at the same time.

Switch the product off releasing either the on/off switch or the safety switch.

#### ANGLE ADJUSTMENT (FIG. D1-D3)

The angle of the main handle can be adjusted in five positions.

Press the angle adjustment button(11) and hold it in position.

Turn the main handle clockwise or anticlockwise.

Release the angle adjustment button and turn the main handle until it locks in place.

#### TRIMMING

Cut and remove branches exceeding the cutting capacity of this product using a proper pruner before operation.

Move the cutting device lightly through the cutting surface in a sweeping motion following the shape of the hedge or shrub.

A slight tilt downwards of the cutting device in the direction of motion is recommended for optimum cutting performance.

Do not to rush and do not attempt to cut too much with one stroke of the cutting device.

First cut both sides from the bottom cutting upwards to the top.

This will prevent any of the trimmings falling into the path of the area still to be cut (Fig. E).

After cutting the sides proceed to the top. Try to keep the cutting device angled at approximately 15° to the cutting surface (Fig. F).

Cut in a number of stages if the area being cut is particularly long to achieve a better result; smaller trimmings will allow for easy composting.





**NOTE:** While trimming, the cutting device is possible to be blocked. So the product will turn off automatically due to over current. Therefore release the on/off switch for over 3s and then press down again to go on with trimming.

## OVERLOAD, TEMPERATURE AND CHARGING PROBLEM

PROBLEM	TOOL / BATTERY STATUS	POSSIBLE CAUSE	SOLUTION
Overload protection	Product suddenly stops	Extremely high torque, binding and stalling situations, overloading of the tool	Relieve the load immediately, reset the tool by switching off and back on again.
Temperature extremely high	The first and the third LED light of the POWER BAR will be flashing alternately	Battery temperature exceeds 77°C during operation	Cool down the battery to below 77°C for operation and below 57°C for charging.
Low charge	Power for the tool will drop quickly; The first LED on the POWER BAR begins to flash	The battery pack is under 5% charge	Remove the battery pack from the tool and charge it
Other problems	Short charges	Not fully charged	Make sure that battery is fully charged every time by allowing the charger to complete its full charging cycle
		Poor storage condition	Always remove battery from the tool and charger when not in use and store in a dry secure place. Avoid charging of storing your battery in temperatures below 5°C and above 40°C. Cool down a hot battery pack from a tool that has just been operated for approximately 30 minutes before storage



+



## CARE & MAINTENANCE



**WARNING!** Always switch the product off, remove the battery pack and let the product cool down before performing inspection, maintenance and cleaning work!

Only perform care and maintenance work according to these instructions!  
All further works must be performed by a qualified specialist!

### BLADE CLEANING AND LUBRICATING



**WARNING!** Wear safety gloves when working on the cutting device and close to it! Use appropriate tools to remove debris e.g. a brush or wooden stick! Never use your bare hands!

Keep the blade (1) clean and free of debris. Remove trimmings.

Apply a small amount of suitable lubricant on the cutting device to retain a good cutting performance.

Keep the blade (1) sharp. Have a worn or damaged cutting device replaced with a new one of the same type by a qualified specialist.

Adjustment of the distance between blades is not necessary, as this is predetermined by the manufacturer.

If the cutting device overheats during operation, it is necessary to lubricate the internal surfaces of the blades. (Fig. G)



**WARNING!** This operation must only be performed when the blades have stopped running and the motor is switched off.

### CLEAN

- Clean the product with a dry cloth. Use a brush for areas that are hard to reach.
- In particular clean the switches and air vents after every use with a cloth and brush.
- Check for worn or damaged parts. Replace worn parts as necessary or contact an authorised service centre for repair before using the product again.



**NOTE:** Do not use chemical, alkaline, abrasive or other aggressive detergents or disinfectants to clean this product as they might be harmful to its surfaces.

## MAINTENANCE

Your tool requires no maintenance.

There are no user serviceable parts in your power tool.

Before and after each use, check the product and accessories (or attachments) for wear and damage. If required, exchange them for new ones as described in this instruction manual. Observe the technical requirements.

## TRANSPORTATION



**WARNING!** Always carry the product by its main handle.

- Switch the product off and remove the battery pack.
- Protect the product from any heavy impact or strong vibrations which may occur during transportation in vehicles.
- Secure the product to prevent it from slipping or falling over.

## STORAGE

- Switch the product off and remove the battery pack.
- Clean the product as described above.
- Store the product and its accessories in a dark, dry, frost-free, well-ventilated place.
- Always store the product in a place that is inaccessible to children. The ideal storage temperature is between 10 °C and 30 °C.
- We recommend using the original package for storage or covering the product with a suitable cloth or enclosure to protect it against dust.

## RECYCLING AND DISPOSAL



Waste electrical products should not be disposed of with household waste. Please recycle where facilities exist. Check with your Local Authority or retailer for recycling advice. For further information visit [www.recycle-more.co.uk](http://www.recycle-more.co.uk)

## DISPOSAL OF AN EXHAUSTED BATTERY PACK



To preserve natural resources, please recycle or dispose of the battery pack properly. This battery pack contains Li-Ion batteries. Consult your local waste authority for information regarding available recycling and/or disposal options. Discharge your battery pack by operating your tool, then remove the battery pack from the tool housing and cover the battery pack connections with heavy-duty adhesive tape to prevent short circuit and energy discharge. Do not attempt to open or remove any of the components.



## GUARANTEE

At **Erbauer** we take special care to select high quality materials and use manufacturing techniques that allow us to create ranges of products incorporating design and durability. That's why we offer a 3 year trade guarantee against manufacturing defects on our **Erbauer** power tool products.

This power tool is guaranteed for 3 years from the date of purchase, if bought in store, delivered or bought online. You may only make a claim under this guarantee upon presentation of your sales receipt or purchase invoice. Please keep your proof of purchase in a safe place.

This guarantee covers product failures and malfunctions provided the **Erbauer** power tool was used for the purpose for which it is intended and subject to installation, cleaning, care and maintenance in accordance with standard practice and with the information contained above and in the user manual. This guarantee does not cover defects and damage caused by or resulting from:

- Normal wear and tear, including accessory wear
- Overload, misuse or neglect
- Repairs attempted by anyone other than an authorised agent
- Cosmetic damage
- Damage caused by foreign objects, substances or accidents
- Accidental damage or modification
- Failure to follow manufacturer's guidelines
- Loss of use of the goods

This guarantee is limited to parts recognised as defective. It does not, in any case, cover ancillary costs (movement, labour) and direct and indirect damage.

If the **Erbauer** power tool is defective during the guarantee period, then we reserve the right, at our discretion, to replace the item with a product of equivalent quality and functionality or to provide a refund.

This guarantee only applies to the country of purchase or delivery and is not transferrable to any other countries. This guarantee is non-transferrable to any other person or product. Relevant local law will apply to this guarantee.

Guarantee related queries should be addressed to a store affiliated with the distributor you purchased the **Erbauer** power tool from.





This guarantee is in addition to and does not affect your statutory rights relating to faulty goods as a consumer.

## CUSTOMER CARE AND TECHNICAL HELPLINE

### A better way to repair your tools

Kingfisher takes special care in creating high-quality garden power tools that are designed to last. But if a fault develops with your garden power tool and you need to claim under the guarantee, the Customer Care and Technical Helpline can support with technical assistance or if required, arrange a free courier collection from your home, assess your garden power tool for fault, repair it, and return it.

Deciding to repair your product rather than buying a replacement and adding to the mountain of waste is a more sustainable choice and you will be doing your bit for the environment.

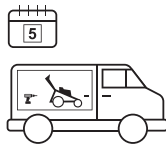
How does it work?				
				
<b>Step 1</b> Find your proof of purchase and get in touch with the Customer Care and Technical Helpline.	<b>Step 2</b> Chat to them about the problem with your tool.	<b>Step 3</b> They will provide technical and user advice or alternatively arrange a courier collection from your home.*	<b>Step 4</b> The team will assess and test and if necessary, repair your product back to full working order.	<b>Step 5</b> Your repaired tool will be returned to you via courier within 5-7 working days*.



**NOTE:** \*please note that before collection, all fuel must be removed from petrol powered machines

### Get in touch

If you need help or more information, please contact the Customer Care and Technical Helpline:

UK: 0800 0789647

Eire: 1800 932226

Opening hours are Monday – Friday, 8am-5pm

## AVAILABILITY OF SPARE PARTS

Contact the customer service helpline for assistance or visit [www.kingfisherspares.com](http://www.kingfisherspares.com)

For assistance contact the customer services helpline:

UK 0800 0789647 [uk@Kingfisherservice.com](mailto:uk@Kingfisherservice.com)

EIRE 1800 932226 [eire@kingfisherservice.com](mailto:eire@kingfisherservice.com)

Further information about this product can also be found at:

[www.kingfisher.com/products](http://www.kingfisher.com/products)

## 01 TECHNICAL SPECIFICATIONS

Rated voltage:	18 V d.c
Rated no-load speed $n_0$ :	2800 /min
Max. cutting length:	510 mm
Blade length:	550 mm
Max. cutting capacity:	25 mm
Net weight (without battery pack):	2.8 kg
Ambient temperature range for tool and battery use: 0°C to 40°C	

### For use with battery pack and charger as below:

Battery pack model:	EBAT18-Li-2 / EBAT18-Li-4 / EBAT18-Li-5 / EHPB18-Li-4/ EHPB18-Li-8 (sold separately)
Charger model:	EC18-Li / EFC18-Li / EMC18-Li (sold separately)
Measured sound pressure level $L_{pA}$ :	66.52 dB(A)
Uncertainty K:	1.5 dB(A)
Measured sound power level $L_{WA}$ :	86.52 dB(A)
Uncertainty K:	1.5 dB(A)
Guaranteed sound power $L_{WA}$ :	96 dB(A)
Vibration level $a_h$ :	2.928 m/s <sup>2</sup>
Uncertainty K:	1.5 m/s <sup>2</sup>

The sound values have been determined according to noise test code given in EN 60745-2-15, using the basic standards EN ISO 11094 and EN ISO 3744.

The sound intensity level for the operator may exceed 80 dB(A) and ear protection measures are necessary.

The declared vibration value has been measured in accordance with a standard test method (according to EN 60745-1) and may be used for comparing one product with another. The declared vibration value may also be used in a preliminary assessment of exposure.



**WARNING!** Depending on the actual use of the product the vibration values can differ from the declared total. Adopt proper measures to protect yourself against vibration exposures. Take the whole work process including times the product is running under no load or switched off into consideration. Proper measures include among others regular maintenance and care of the product and accessories, keeping hands warm, periodical breaks and proper planning of work processes.

## RATING LABEL EXPLANATION

**EHT18-Li = MODEL NUMBER**

**E = ERBAUER**

**HT = HEDGE TRIMMER**

**18 = 18 V d.c.**

**Li = LITHIUM ION**

## 02 SYMBOLS

On the product, the rating label and within these instructions you will find among others the following symbols and abbreviations. Familiarize yourself with them to reduce hazards like personal injuries and damage to property.

V~ Volt, (alternating voltage)      V  Volt, (direct current voltage)

W Walt      mA Milliampere

A Ampere      /min per minute

mm Millimetre      kg Kilogram

dB(A) Decibel (A-rated)      m/s<sup>2</sup> Metres per second squared



Caution / Warning.



Read the instruction manual.



Wear protective gloves.



Wear protective footwear.



Wear hearing protection.



Wear eye protection.



Wear respiratory protection.



Do not expose to rain or wet conditions.





Switch the product off and remove the battery pack to disconnect from the power supply before assembly, cleaning, adjustments, maintenance, storage and transportation.



Keep fingers away from moving cutting device!



Guaranteed sound power level

Manufacturing date code: Year of manufacturing (20yy) and week of manufacturing (Wxx)



Objects thrown by the product could hit the user or other bystanders.

Always ensure that other people and pets remain at a safe distance from the product when it is in operation. In general, children must not come near the area where the product is.



The product complies with the applicable European directives and an evaluation method of conformity for these directives was done.



WEEE symbol. Waste electrical products should not be disposed of with household waste. Please recycle where facilities exist.

Check with your Local Authority or local store for recycling advice.

EN



## DECLARATION OF CONFORMITY











**Manufacturer,Fabricant,Producent,Producător,Fabricante:**

UK Manufacturer:  
Kingfisher International Products Limited  
3 Sheldon Square London, W2 6PX  
United Kingdom  
[www.kingfisher.com/products](http://www.kingfisher.com/products)

EU Manufacturer:  
Kingfisher International Products B.V.  
Rapenburgerstraat 175E  
1011 VM Amsterdam  
The Netherlands  
[www.kingfisher.com/products](http://www.kingfisher.com/products)

EN	<a href="http://www.diy.com">www.diy.com</a> <a href="http://www.screwfix.com">www.screwfix.com</a> <a href="http://www.screwfix.ie">www.screwfix.ie</a>	To view instruction manuals online, visit <a href="http://www.kingfisher.com/products">www.kingfisher.com/products</a>
FR	<a href="http://www.castorama.fr">www.castorama.fr</a> <a href="http://www.bricodepot.com">www.bricodepot.com</a>	Pour consulter les manuels d'instructions en ligne, rendez-vous sur le site <a href="http://www.kingfisher.com/products">www.kingfisher.com/products</a>
PL	<a href="http://www.castorama.pl">www.castorama.pl</a>	Aby zapoznać się z instrukcją obsługi online, odwiedź stronę <a href="http://www.kingfisher.com/products">www.kingfisher.com/products</a>
ES	<a href="http://www.bricodepot.es">www.bricodepot.es</a>	Para consultar los manuales de instrucciones en línea, visite <a href="http://www.kingfisher.com/products">www.kingfisher.com/products</a>
PT	<a href="http://www.bricodepot.pt">www.bricodepot.pt</a>	Para consultar manuais de instruções online, visite <a href="http://www.kingfisher.com/products">www.kingfisher.com/products</a>
RO	<a href="http://www.bricodepot.ro">www.bricodepot.ro</a>	Pentru a consulta manualele de instrucțiuni online, vizitați <a href="http://www.kingfisher.com/products">www.kingfisher.com/products</a>
TR	<a href="http://www.koctas.com.tr">www.koctas.com.tr</a>	Kullanım kılavuzuna internet üzerinden ulaşmak için <a href="http://www.kingfisher.com/products">www.kingfisher.com/products</a> adresini ziyaret edin